

GuidePRO Band Saw Feed Guide



OWNERS MANUAL:

Bow Products GuidePRO Band Saw Feed Guide is designed primarily for use with Band Saws. This manual shows proper set up, use and adjustment procedures. Note: The GuidePRO Extension Kit accessory has a 10" Feather for taller panel feeds (sold separately, see below).

⚠ WARNING: When using Electric Power Tools with the GuidePRO, Be sure to understand and adhere to the tool manufacturer's instructions including the safety precautions contained herein to avoid possibility of fire, Electric Shock or Personal injury. Read and understand all instructions before using this product. If you have concerns, confusion or questions, stop and call us Toll Free at: 844.895.4488

⚠ WARNING: When using the GuidePRO, be sure to adhere to the following general Safety guidelines. Failure to do so can result in serious injury or loss of limb or loss of life.

- Always ensure Power to the Band Saw is Shut Off until the GuidePRO and work piece are set up, positioned clear of the cutting blade and are ready for in feed.
- Always ensure there is clearance for the work piece to feed through the Blade.
- Once the GuidePRO is set, ALWAYS feed the work piece with both hands on the work piece, there is no need to hold the GuidePRO in place. ALWAYS finish the cut with Push Stick or pull the work piece through from the opposite side of the blade. Keep your hands clear of the blade.
- If feeding multiple work pieces of similar material/dimension to make the same cut over and over, ALWAYS turn the Band Saw Power Off in between GuidePRO set up and feeds.
- When done with cut, ALWAYS turn the Band Saw off before removing the GuidePRO from the Miter Slot.

⚠ WARNING: California Prop 65: This Product may contain one or more chemicals known to the state of California to cause cancer and birth defects or other reproductive harm.

Familiarize yourself with the GuidePRO

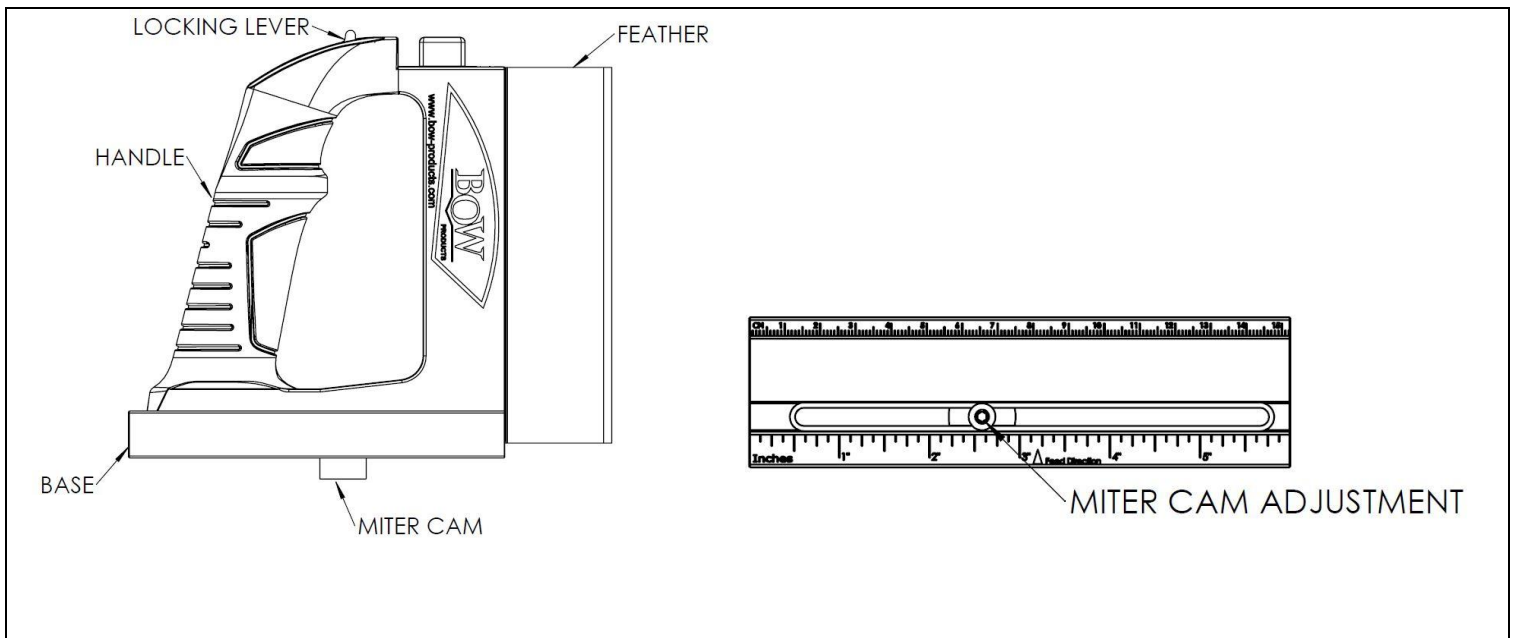



SET UP:  **WARNING:** Always ensure the Power Saw is turned off during set up. The GuidePRO is a very easy set up once you understand the tool. The detailed explanations and pictorial below explain the set ups, cuts and adjustments.

IMPORTANT > PRACTICE SET UP: Before making your first cut, practice set up of the GuidePRO several times to get comfortable with set up, pressure setting and positioning. **TIP:** Watch instructional videos for Set Up, Cutting and Tuning adjustments on our website: www.bow-products.com in the GuidePRO product section.

- 1. Set Position of the Miter Cam on the GuidePRO Base:** The correct position allows you to push the GuidePRO Feather against the work piece and apply pressure to the work piece against the fence. The Miter Cam comes assembled to the GuidePRO Base. With the Allen Wrench provided, you can loosen/ adjust the position of the Cam on the Base (Diagram 1 below) and reposition to your band saw Miter Slot. With the Cam loose, set the GuidePRO Base in the Miter Slot (diagram 2) to get an approximate position of the Cam on the Base. Push the GuidePRO Feather against the work piece (Diagram 3) and check the Cam position, and then tighten with the Allen Wrench. The GuidePRO Handle has 5" (127mm) of slide range on the GuidePRO Base. You don't have to be exact in positioning the Miter Cam into the Miter Slot. The GuidePRO fits 3/8" x 3/4" Miter Slots, and works with Miter Slots that range from 2" to 8" (50mm to 203MM) from the blade.
- 2. Setting the Work Piece, Fence and Band Saw Blade:** As with any Band Saw cut, the first step is to position the fence in relation to the blade and the work piece. The GuidePRO has tools to help you do this. The GuidePRO Base is detachable and has measurements in metric and imperial that helps you measure the distance from the fence to the blade. The GuidePRO Base also acts as a right angle square to help you ensure the fence is square to the table. Once your Band Saw is set, proceed to the GuidePRO positioning.
- 3. GuidePRO Positioning on the Work Piece:** Place the GuidePRO Miter Cam into the Miter Slot (diagram 2). The GuidePRO is intended to slide along the Miter Slot perpendicular to the work piece (Feather facing toward work piece) until you are in position to apply pressure on the work piece. Note that the GuidePRO Locking Lever must be in the open/up position (Diagram 3). Turn the GuidePRO clockwise until the Miter Cam comes to a stop in the Miter Slot (Diagram 4). At this point, you want the work piece approximately a half inch to an inch away from the blade depending on your preference. You want the Feather approximately a 1/4" (6.5mm) back from the front of the work piece. Then in one motion, with one hand pushing the work piece and the other hand on the GuidePRO Handle (with your thumb up over the Locking Lever), simultaneously apply pressure and move the work piece forward toward the blade. The Feather starts to flex depending on how much pressure you apply. You then press down on the Locking Lever and lock the GuidePRO pressure in place (Diagram 5). The Objective is to end up with the work piece near the blade (but not touching) with the desired pressure, and the Feather positioned approximately 1/4" back from the front of the work piece.

Important Positioning Considerations:

-  **WARNING:** Always ensure the Power Saw is turned off during set up
 - The distance that the work piece is from the blade once you set up is a matter of preference and safety consideration. Bow Products will NOT tell you exactly how close the work piece should be next to the blade. Consult your Band Saws owner's manual.  **WARNING: DO NOT** have the GuidePRO or the work piece in contact with the blade as you power up the Band Saw. Doing so can result in damage to your GuidePRO, your Band Saw and possibly severe injury to you. Many woodworkers keep the distance close to the blade (Approx. 1/4" (6.5mm)) to minimize chatter and get a cleaner cut all the way through the board.
 - The positioning of the GuidePRO Feather in relation to the work piece. Our preference is to have the GuidePRO Feather Approx. 1.4" (6.5mm) back from the front edge of the work piece.
- 4. Start the Cut:**  **WARNING:** Always finish the cut with a push stick or pull the work piece through the blade from the opposite side of the blade. Never push the work piece forward with your hand or the GuidePRO. Doing so can result in damage to GuidePRO, Band Saw and possibly severe injury to you.

Once the GuidePRO is set up and locked into position, there is no need to hold the GuidePRO with your hand. It is locked in on the work piece against the fence and is under pressure. Start the Band Saw and feed the material with both hands. Finish the cut with a push stick. Once the material passes through the GuidePRO, the GuidePRO will become loose in the miter track as it is no longer under pressure against the work piece. Note the Locking Lever is still pressed down securing the Handle to Base. If you wanted to make similar repetitive cuts (same work piece dimensions and same fence position, simply feed in the next work piece and push it through the Feather (positioned in the same relationship to the blade). No need to reset the Feather pressure, leave the Lever Lock closed.

RECOMMENDATION: PRACTICE SET UP BEFORE YOU START CUTTING

GuidePRO Tool Adjustments:

GuidePRO Feather Positioning: The GuidePRO Feather slides up and down in the GuidePRO Handle Slot. The Feather should always be down, close to or flush to the Band Saw table top. This ensures pressure of the Feather is applied along the entire work pieces. If the Feather is not long enough, you can always buy our GuidePRO Extension Kit (See Below).

GuidePRO Locking Lever Adjustment:

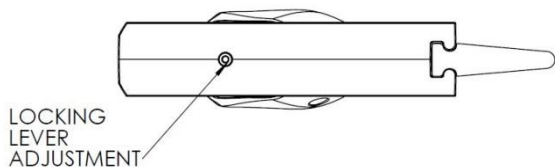

Turn the Lever Shaft clockwise to extend the shaft, Counterclockwise to retract. Adjust only a quarter turn at a time.

As you press forward on the GuidePRO Locking Lever during set up, this secures the Handle/Feather position to the Base and locks in the pressure against the work piece (refer to set up instruction above). The Locking Lever is attached to the Lever Shaft that extends down through the GuidePRO Handle assembly and slightly extends out of the bottom of the Handle. The distance that the Lever Shaft extends out of Base comes from the factory preset at 1/16" (1.6mm) and should stay in place for several uses without having to be reset.

To understand this important setting and when to make an adjustment, if the Lever Shaft sticks out to far, then the Lever Lock will not close all the way and you can't secure the GuidePRO handle to the Base. To fix, turn the Lever Shaft counterclockwise a quarter turn at a time until Lever Lock fully closes and secures the Handle to the Base. Conversely, if the Lever Shaft were recessed too far into the Handle, while the Lever Lock will close all the way, the Lever Shaft will not protrude enough to secure the Handle to the Base, meaning the Handle would slide on the Base and you could not hold Feather pressure against the work piece. To fix, turn the Lever Shaft clockwise a quarter turn at a time until Lever Lock closes and secures the Handle to the Base.

CRITICAL SETTING: The Adjustments to the Lever Shaft are very minimal. DO NOT unscrew (Counterclockwise) the Lever Shaft all the way out as you risk disconnecting the Lever Shaft from the Lever.

WARRANTY: GuidePRO comes with a One Year Limited warranty for Defects in Materials or Workmanship.

CUSTOMER SERVICE: Please view our website at www.Bow-Products.com for additional information on this tool. You may also contact us at 844.895.4488.

GuidePRO EXTENSION KIT: You may purchase the GuidePRO Extension Kit to add 1 10" feather to the GuidePRO. This is ideal for taller panel feeds. The part Number is GP7. Please visit our website at www.Bow-Products.com for ordering information.

REPLACEMENT PARTS: The only replaceable part is the GuidePRO 6" feather: Part number 70014-01. Please visit our website at www.Bow-Products.com for ordering information.

Bow-Products
8778 Boyce Rd.
Corfu, NY 14036

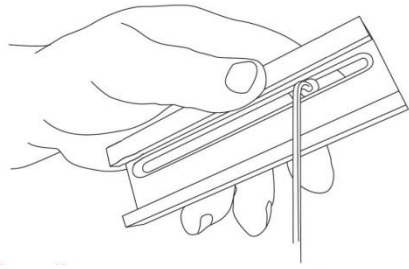

Diagram 1: Adjust position of Miter Cam in GuidePRO Base

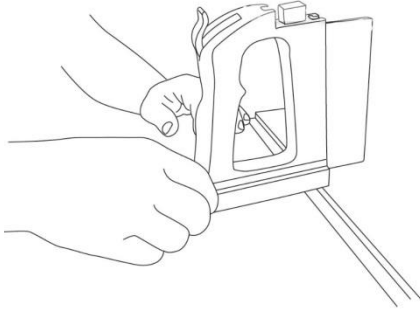

Diagram 2: Set GuidePRO Miter Cam in miter slot

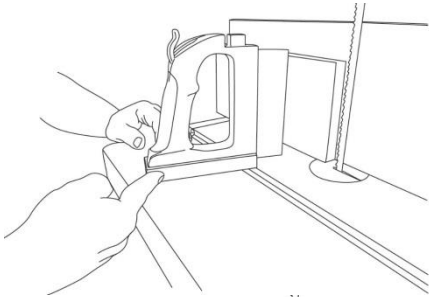

Diagram 3: Position the GuidePRO Feather against work piece and rotate clockwise until Miter Cam stops in the miter slot

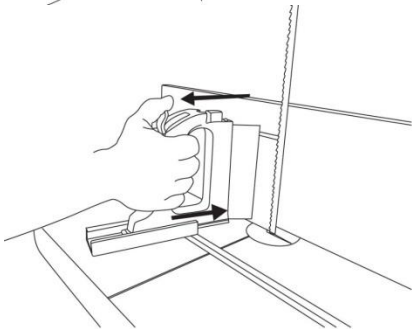

Diagram 4: With Locking Lever open, push GuidePRO Feather against work piece with desired pressure

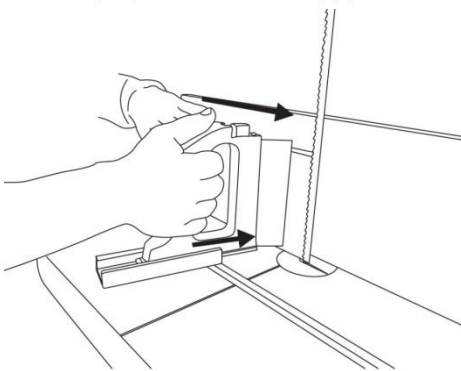

Diagram 5: Press down Locking Lever to hold pressure and position