

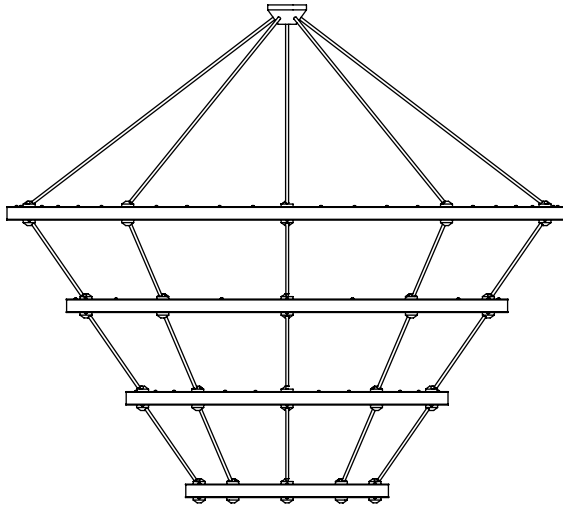

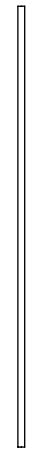

CONTENTS

Halo - 4 Rings

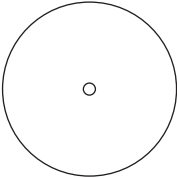
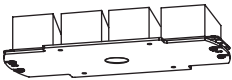
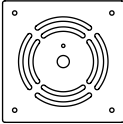

Stem and 1/4 IPS
Threaded Rod



<p>Canopy</p> 	<p>Driver Assembly</p> 	<p>Canopy Crossbar</p> 	<p>Hang-straight</p> 
	<p>Canopy Nut</p> 	<p>8-32 Crossbar Screws (2)</p> 	<p>Wago Connectors (6)</p> 

SAFETY INFORMATION

Only suitable for direct mounting on non-combustible surfaces.
Under no circumstances can Halo Chandeliers be mounted on normally flammable surfaces.
Suitable for dry, indoor use only.
Maximum ambient temperatures: 25° C

Stem and cover tube length adjustment

Note: Please contact a licensed electrician.

Example fixture only:

To measure length of stem, first determine overall length (OAL), subtract 1" for the canopy height and subtract the fixture height from the OAL. Fixture height is measured from bottom of the fixture to stem connection point.

The resulting measurement is the final stem length.

Ex. The fixture below has an OAL of 60" and a fixture height of 36".

$$60'' \text{ OAL} - 2.5'' \text{ canopy} - 42'' \text{ fixture height} = 15.5'' \text{ stem}$$

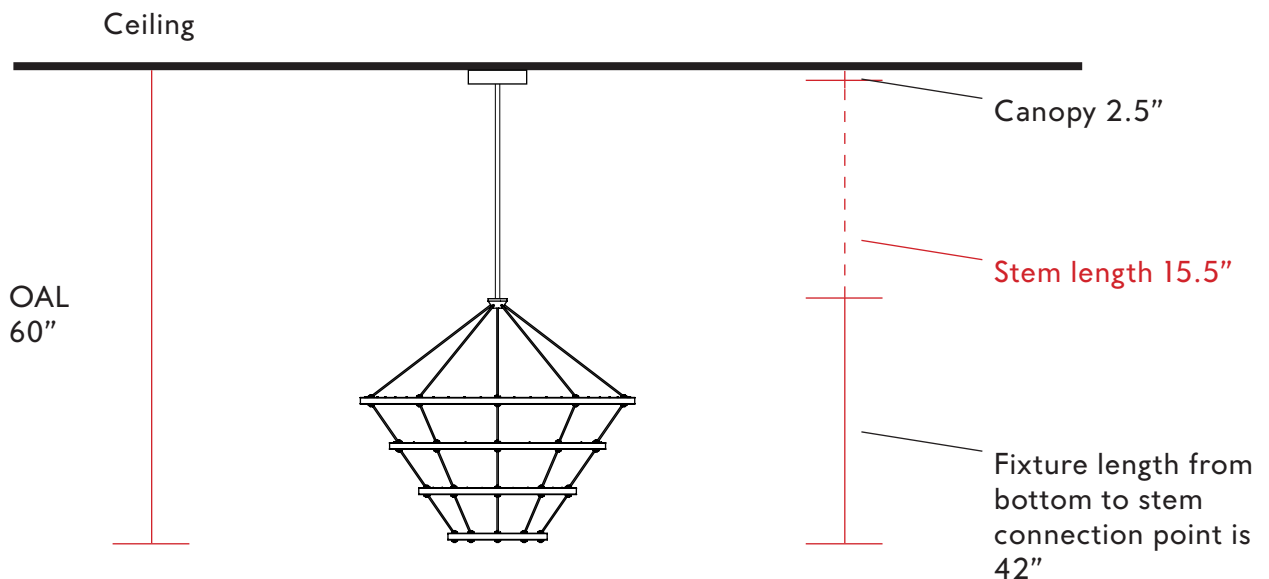

Stem and cover tube length adjustment

Note: Please contact a licensed electrician.

Example fixture only:

1. To customize the length of the provided stem, cut cover tube to desired length. Then cut the inner threaded tube so that it remains .5" longer than the cover tube.

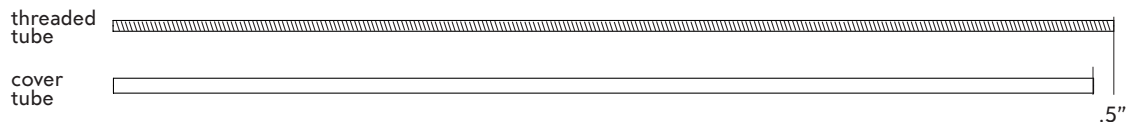

2. Mark the length of the tube required, using a marker or tape. Then hold down the tube with a hand or a clamp, use a hacksaw or electrical tool to cut the tube. Recommended to clean tube after cutting to remove any metal chippings.

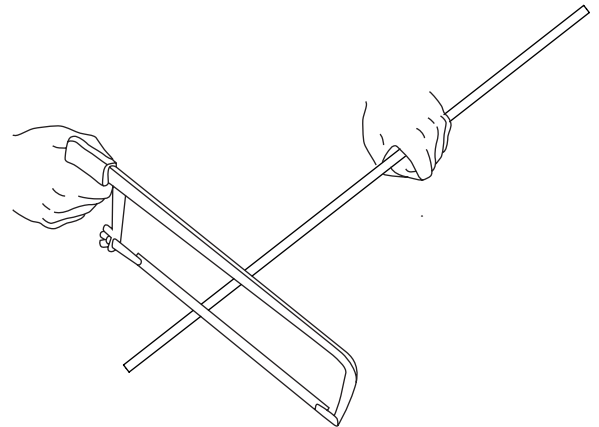

3. Now that the cover tube is cut to 11.5", measure the all thread tube to be 12" long. And place a mark, with a marker or tape.

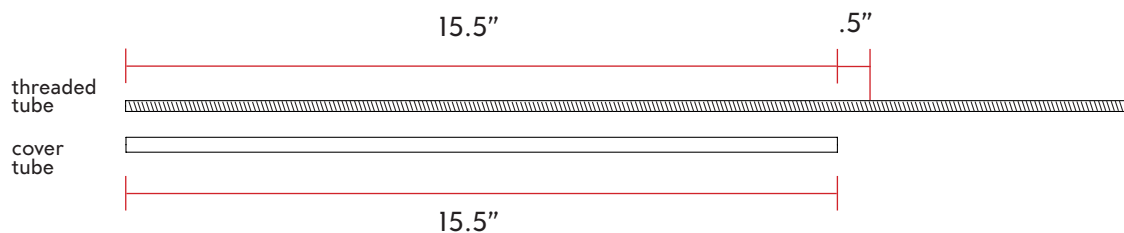

4. Hold down the all thread with a hand or a clamp, use a hacksaw or electrical tool to cut the all thread tube. Recommended to clean all thread tube after cutting to remove any metal chippings.

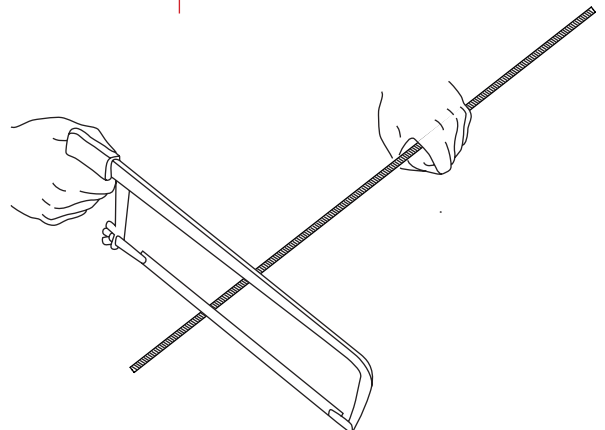

HALO 4 RING | CEILING INSTALLATION

Note: Please contact a licensed electrician.

01. To customize the length of the provided 36-inch stem, cut cover tube to desired length. Then cut the inner threaded tube so that it remains 1/2" longer than the cover tube.

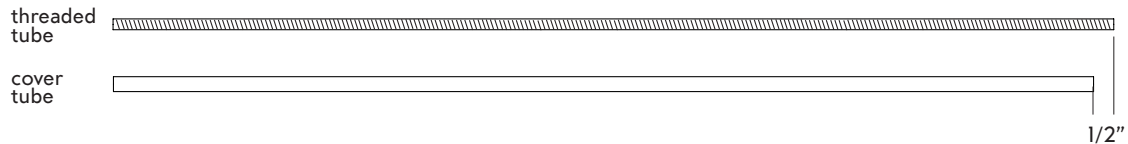

02. Detach crossbar (A) from assembly by unscrewing bottom standoff screws (B).
03. Install the crossbar using #8-32 screws to junction box (C) in ceiling. Pull the lead wires through the center hole in order to make lead connections.
04. Attach the green ground wire to the crossbar with ground screw (D).
05. Make wire connections (E) between junction box leads and the voltage transformer (F).
06. Slide hang-straight nut (G) and canopy (H) down cover tube and screw inner threaded tube into hang-straight (I).
07. Make the secondary wire connection (J) from the drivers to the fixture wires. Feed fixture lead wires from the driver assembly down through the cover tube (K).
08. Raise canopy and hang-straight nut to ceiling and tighten nut around hang-straight. This will tighten canopy flush to ceiling. Make sure to conceal wires and connections inside canopy.

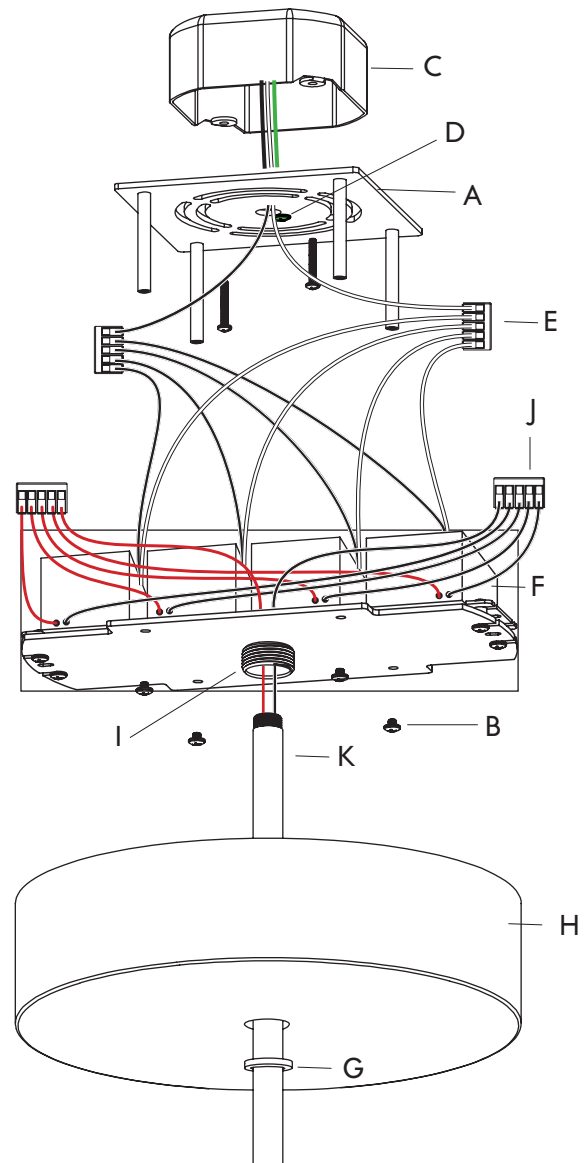

HALO 4 RING | CEILING INSTALLATION

Note: This step requires two people.

09. Separate hub (L) and hub cap (M) by removing five machine screws. Run wires through threaded stem and cover tube and attach to canopy.
10. Carefully lift the fixture so that the hub and cap align. Cut excess wire, strip ends, and make electrical connections (N) between the stem and the fixture. Tuck wire nuts and wires inside the hub and close.
11. Secure the plate and hub back together using same five machine screws.

