

CONTENTS

Castle 9

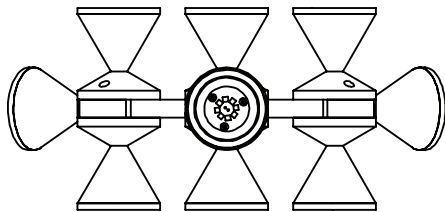

Long Glass
Diffuser (x3)

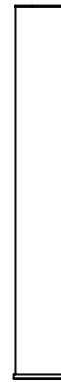

Stem and 1/8 IPS
Threaded Rod



Short Glass
Diffuser (x6)



8/32 J-Box Screws



Crossbar/Driver Assembly

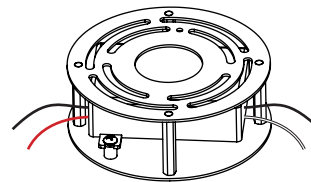

Hangstraight Nut

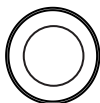

Canopy

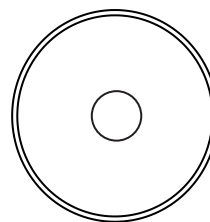

SAFETY INFORMATION

Only suitable for direct mounting on non-combustible surfaces.
Under no circumstances can Castle Chandeliers be mounted on normally flammable surfaces.
Suitable for dry, indoor use only.
Maximum ambient temperatures: 25° C

CASTLE CHANDELIER | CEILING INSTALLATION

Note: Please contact a licensed electrician.

- To customize the length of the provided 36-inch stem, you may cut to desired length.
Then cut the inner all-thread tube to the same length plus 1/2 inch to allow room for threading.

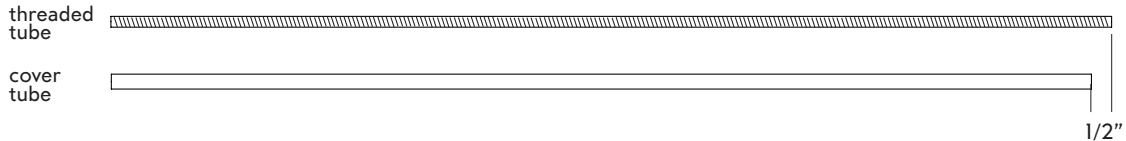

- Detach the crossbar (A) from the driver assembly by unscrewing the 4 screws (set them aside for later), and attach it to the J-box (B) with the provided #8-32 screws.

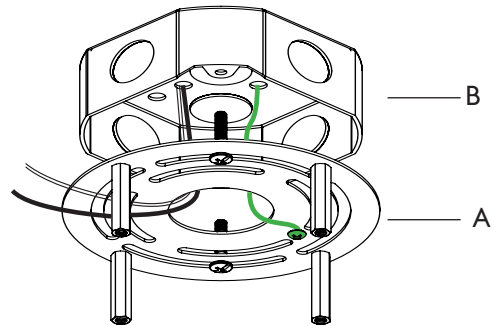

- Pull the ceiling lead wires through the center hole in the crossbar, and connect the ground wire to the crossbar.

- Feed wire from the fixture through the threaded rod (C). Thread the rod a quarter inch into the top hub of the fixture (D).

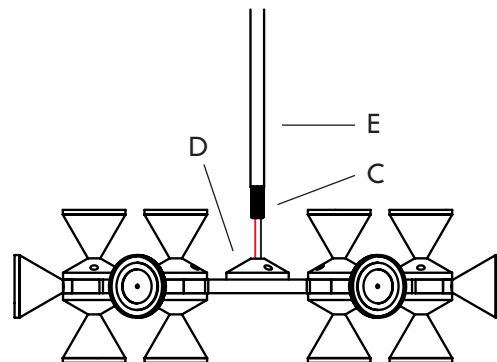

- Slide the cover tube (E) over the threaded tube (C).

CASTLE CHANDELIER | CEILING INSTALLATION

Note: Please contact a licensed electrician.

06. Slide the hangstraight nut (F) and the canopy (G) down the cover tube (E).
07. Feed the fixture wires from the threaded tube (C), through the hangstraight (H). And screw in the threaded tube (C) into the hangstraight (H)
08. Raise the driver assembly plate (I) with the hangstraight, threaded rod and fixture all connected to the crossbar standoffs and screw in with 4 screws (J). Make sure the lead wires feed out to the side.
09. Connect the lead wires to the LED driver with the provided wago connectors (K).
10. Connect the secondary fixture wires with the provided wago connectors (L). Tuck all wires back into the main body.
10. Raise the canopy (G) to the ceiling, and tighten in place with hangstraight nut (F).

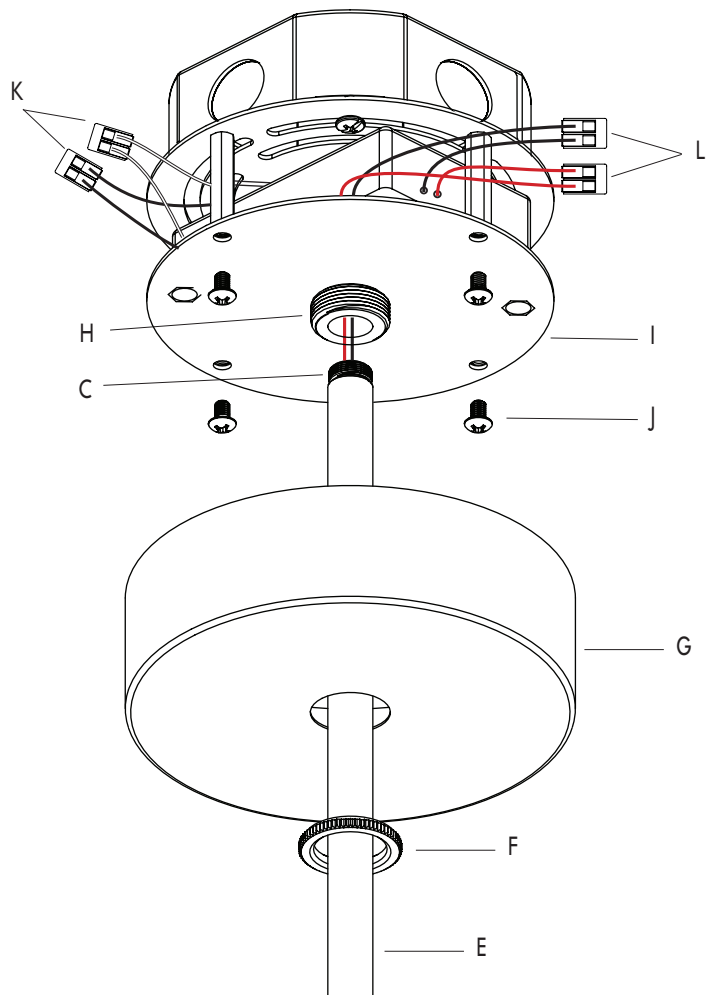

CASTLE CHANDELIER | DIFFUSER INSTALLATION

01. Screw the glass diffusers (A) clockwise into threaded hub (B)

