

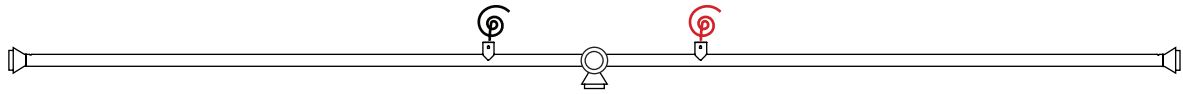





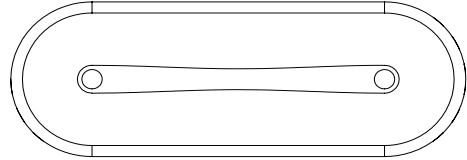
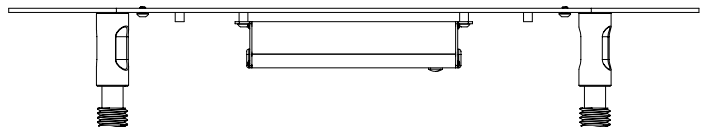
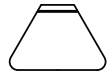

CONTENTS

(x1) Apollo chandelier 5 Lights Lighting Assembly

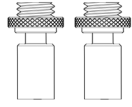

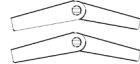
<p>(x2) Threaded tube</p> 	<p>(x2) Cover tube</p> 	<p>(x1) Canopy</p> 		
		<p>(x1) Crossbar assembly</p> 		
		<p>(5x) Glass</p> 	<p>(x7) Wago Connector</p> 	<p>(x2) Hang-straight</p> 
		<p>(x1) L-Key</p> 	<p>(x2) 8-32 Screw</p> 	<p>(x2) Toggle anchor On 240V fixtures only</p> 
		<p>(x2) Wood screw On 240V fixtures only</p> 	<p>(x2) Long 8-32 screw On 240V fixtures only</p> 	<p>(x2) Metal screw On 240V fixtures only</p> 

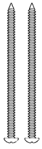
SAFETY INFORMATION

Suitable for damp locations
Maximum ambient temperature: 25°C

APOLLO CHANDELIER | INSTALLATION

Stem and cover tube length adjustment

Note: Please contact a licensed electrician.

Example fixture only:

To measure length of stem, first determine overall length (OAL), subtract 3" for the canopy with hang-straight height and subtract the fixture height from the OAL. Fixture height is measured from bottom of the fixture to stem connection point. The resulting measurement is the final stem length.

Ex. The fixture below has an OAL of 30" and a fixture height of 3".

$$30'' \text{ OAL} - 3'' \text{ canopy} - 3'' \text{ fixture height} = 24'' \text{ stem}$$

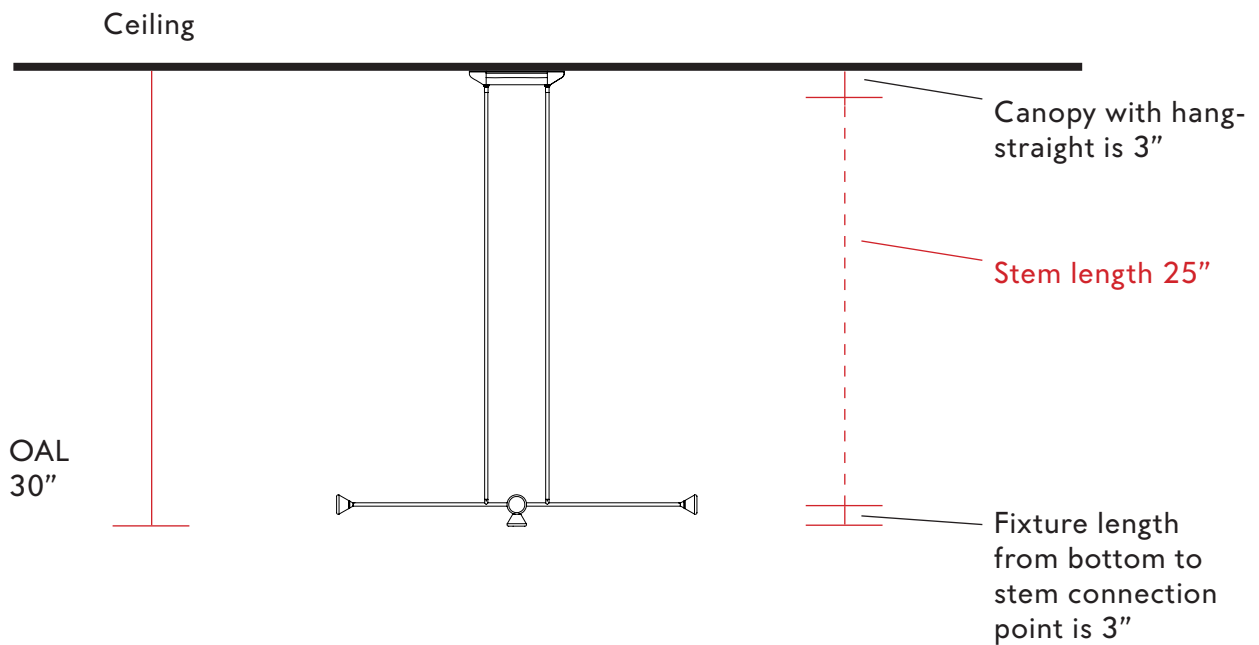

APOLLO CHANDELIER | INSTALLATION

Stem and cover tube length adjustment

Note: Please contact a licensed electrician.

Example fixture only:

1. To customize the length of the provided stem, cut cover tube to desired length.
Then cut the inner threaded tube so that it remains 1/2" longer than the cover tube.

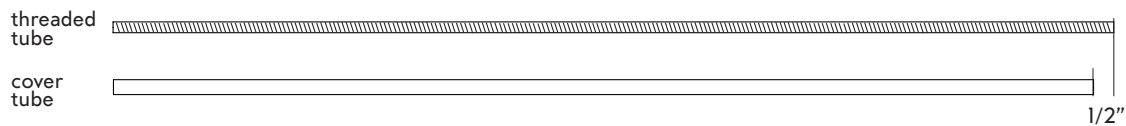

2. Mark the length of the tube required, using a marker or tape. Then hold down the tube with a hand or a clamp, use a hacksaw or electrical tool to cut the tube. Recommended to clean tube after cutting to remove any metal chippings.

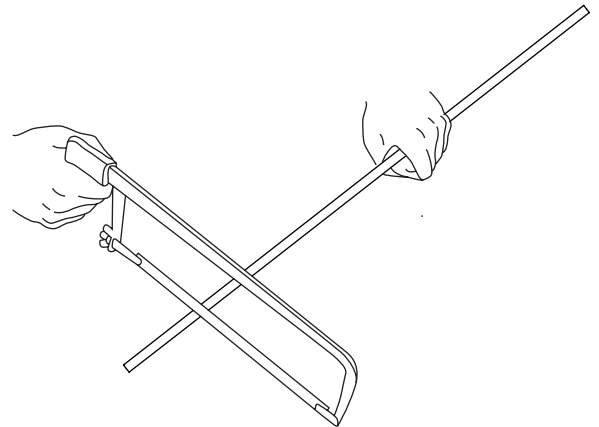

3. Now that the cover tube is cut to 25", measure the all thread tube to be 24 and 1/2" long. And place a mark, with a marker or tape.

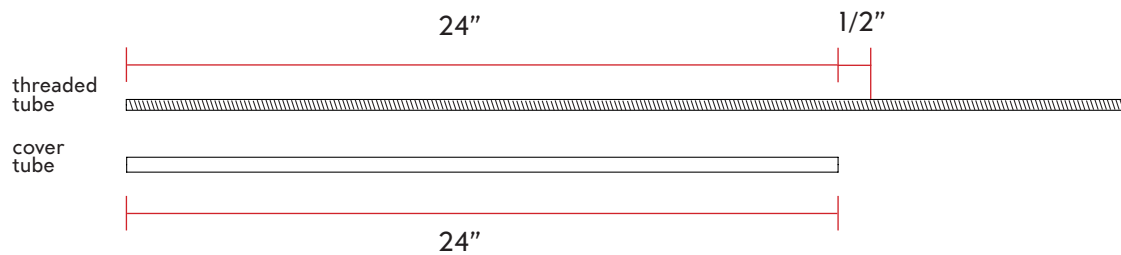

4. Hold down the all thread with a hand or a clamp, use a hacksaw or electrical tool to cut the all thread tube. Recommended to clean all thread tube after cutting to remove any metal chippings.

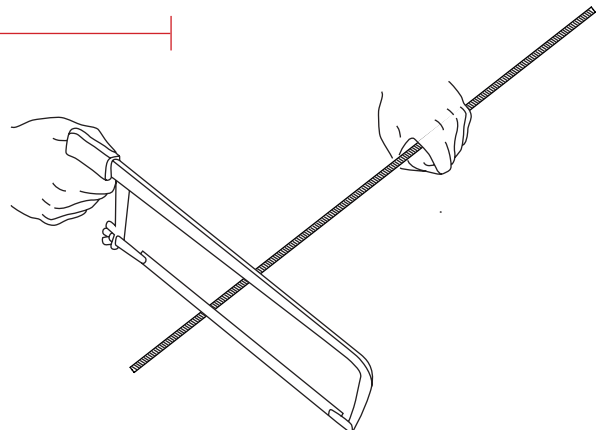

APOLLO CHANDELIER | INSTALLATION

Note: Please contact a licensed electrician for installation. Ensure power is off during installation.

01. Feed each Threaded Tube (A) through each Cover tube (B). Thread a hang-straight (C) on top on each Threaded Tube and carefully maneuver its threaded collars (D) and the Wooden Canopy (E) so they slip downward onto the Cover tubes (B).
02. Feed the wires (F) from the Lighting assembly (G) through each of the Threaded Tube (A), Stem assembly with Wooden Canopy (A-B-C-D-E) and Crossbar assembly (I) as shown below.
03. Secure the assembly by fastening the two threaded tubes (A) to the Crossbar assembly (I), then to the Lighting assembly (G) through the Fishmouths (H).

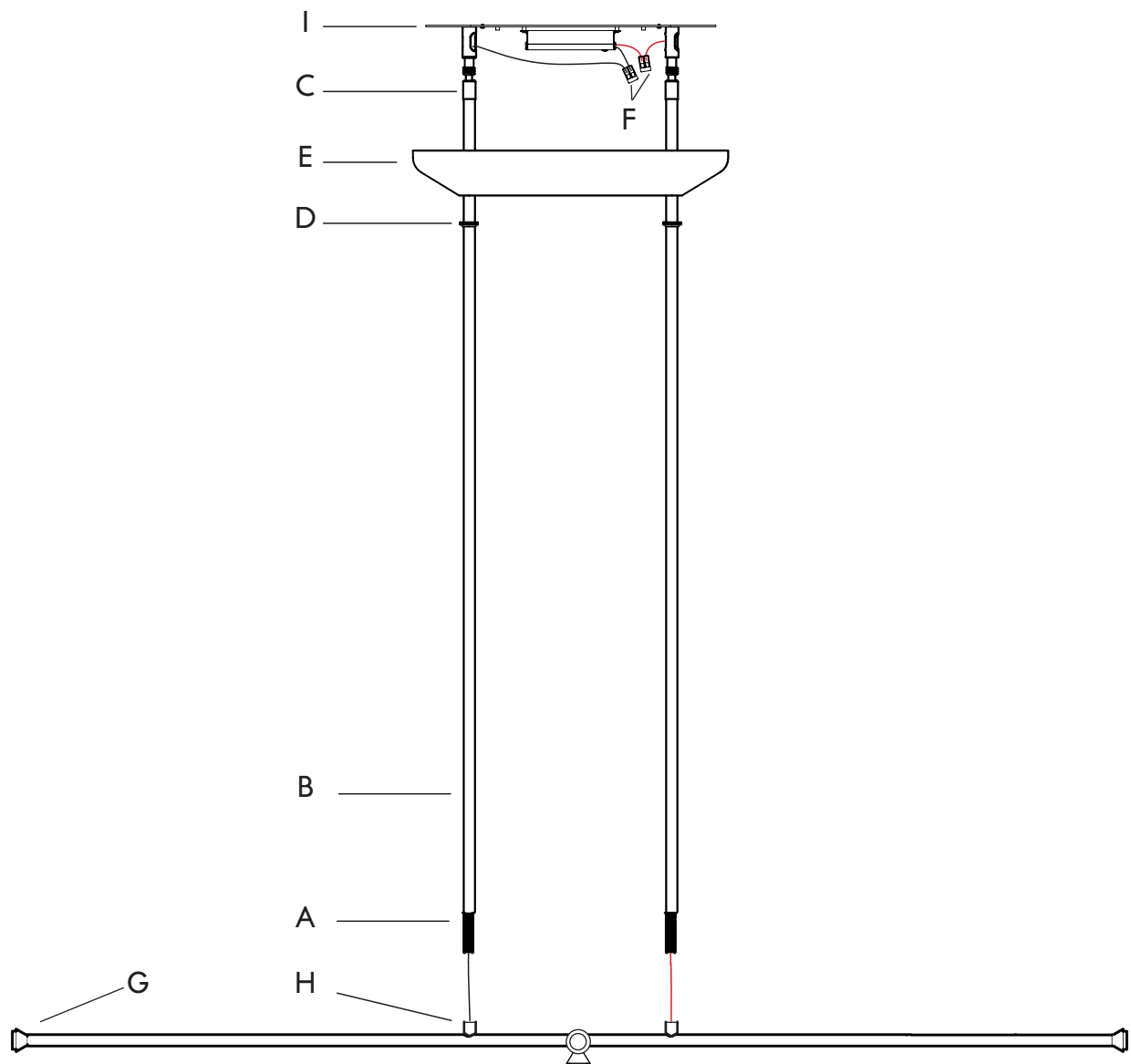

APOLLO CHANDELIER | INSTALLATION

04. Gently lower down the wooden canopy (A) through the stems (B) so it can rest.
Be careful not to scratch the finish.

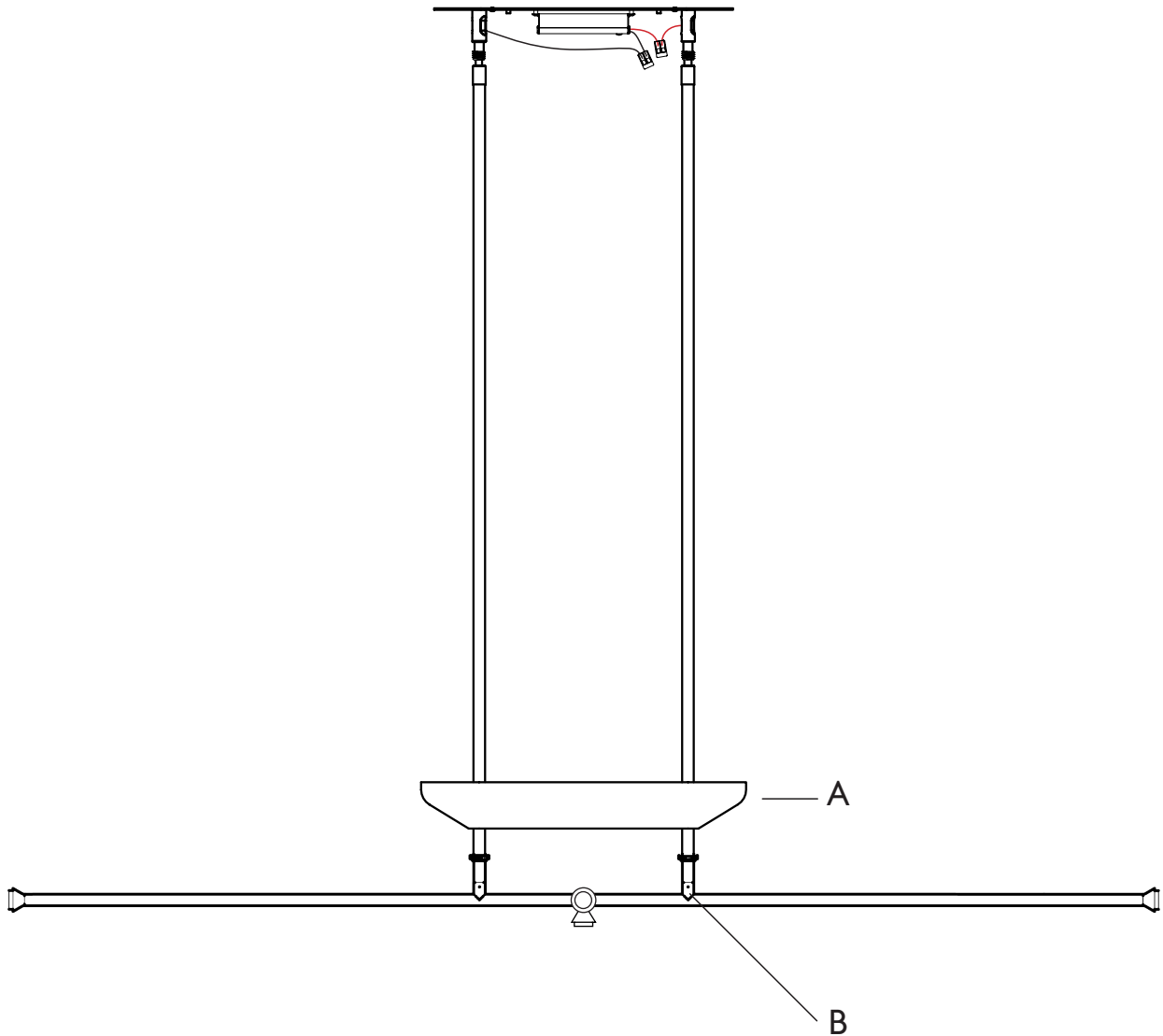

APOLLO CHANDELIER | INSTALLATION

05. Make the electrical connections between the lead AC wires and the driver using the provided Wago Connectors (A)
06. Connect the ground wire to the fixture's crossbar using the provided Wago Connector (B).
07. Secure the fixture by threading the provided screws (D) into the ceiling Junction-Box (C),
(For 240V: Secure the fixture by threading the provided screws (G) into the Toggle Anchors (H))
08. Connect the secondary wires to the fixture using the provided Wago Connectors (E)
(Optional: Connect the 0-10V dimming wires (F) as needed)

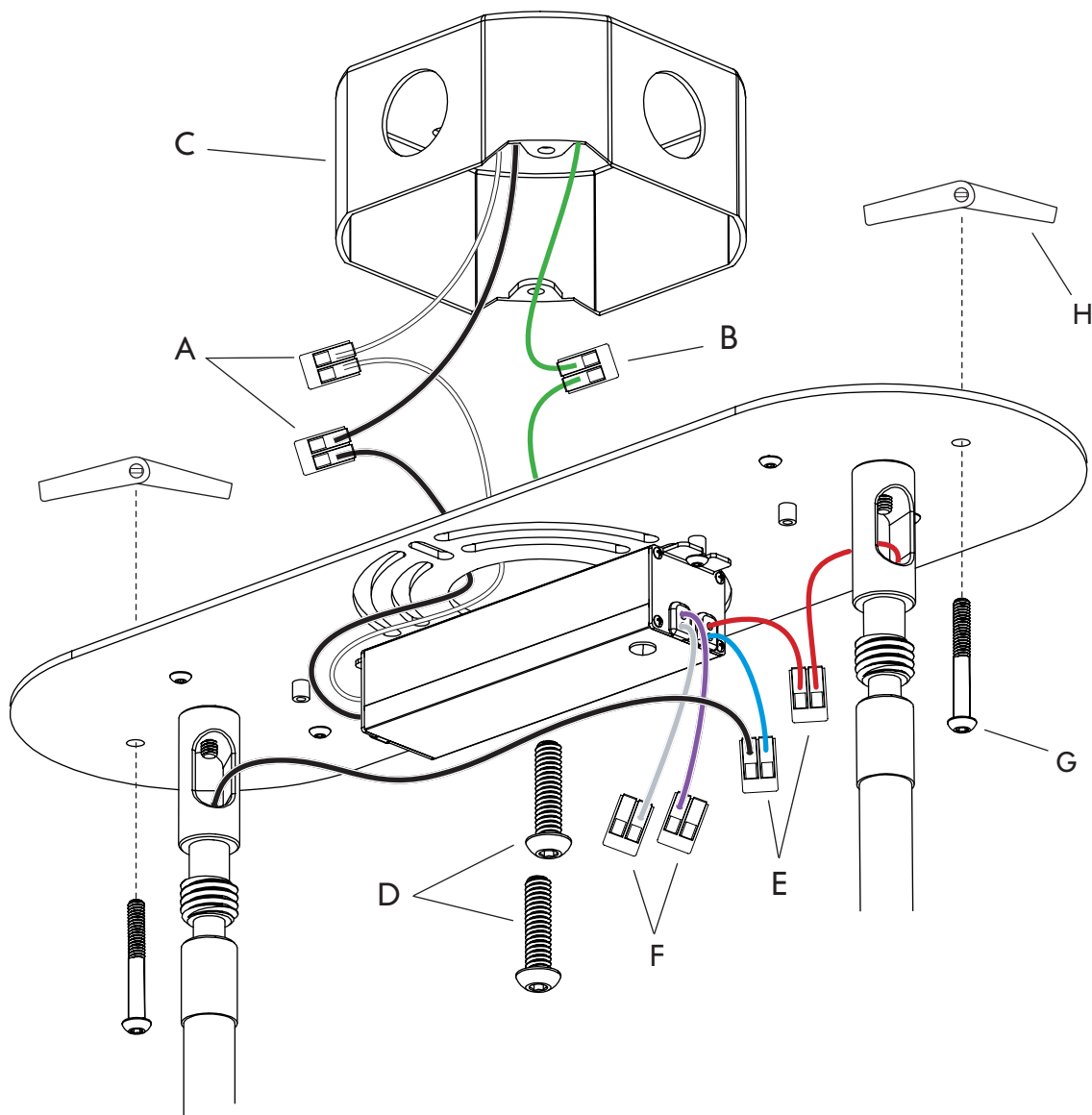

APOLLO CHANDELIER | INSTALLATION

09. Once properly wired, nestle the wires comfortably into the interior of canopy. Raise and secure the canopy (A) with the threaded collars (B), threading them on until the canopy is flush with the ceiling.

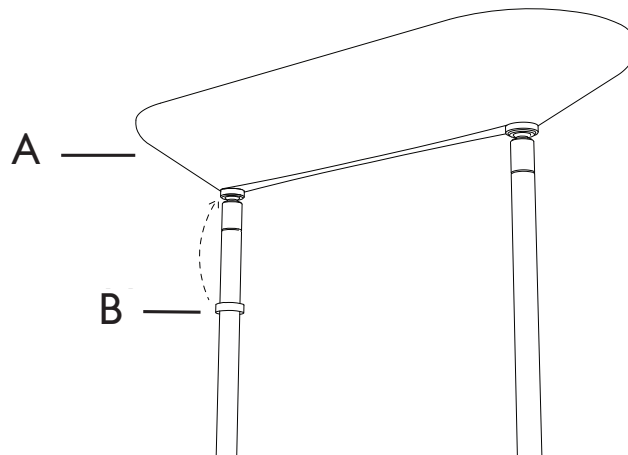

10. Carefully thread the glass diffuser (C) on to the Lighting assembly (D) in a clockwise rotation.

