

DUALTRON *CITY*

The dream of electric technology

PERSONAL MOBILITY User Manual



w w w . d u a l - t r o n . c o m

Company Introduction

Minimotors Co.LTD., is a company who manufactures and distributes personal mobility with a professional production system since 1999.

Minimotors Co.LTD., has been making the electric mobility brand < DUALTRON > to meet the world's people with the aim of making more innovative, more sensuous, and more convenient personal mobility since 1999 and making products that are loved by people in the world. Minimotors Co.LTD., is doing its best to become the world's best electric mobility company.



Brand Introduction

"DUALTRON" brand is a worldwide known electric scooter brand name that Minimotors Co.LTD., designed.

"DUALTRON" is a breakthrough product that combines the world's first dual drive system and the new rubber suspension technology (patent pending). It's a proud Korean luxury brand that has won the world's electric scooter market exporting to more than 30 countries.

DUALTRON®
The dream of electric technology

✓ **Please read the user manual carefully.**

Do not use the product until you understand its functions.
Do not rent the product to anyone who can't operate the product.
*For the first time, the user should use it with a slow speed for safety.

01. General safety guidelines and restrictions	04
02. Product structure.....	06
03. Name of each part	08
04. Product components	09
05. How to use the product.....	10
06. How to use the instrument panel	13
07. How to use the charger correctly.....	16
08. Safety precautions for Lithium-ion battery.....	17
09. Safety guidelines before driving	18
10. Maintenance	19
11. Important checklist.....	20
12. Product specifications.....	22

Before Reading Manual

This manual contains important information to help you to use your product more safely. For safe use, it is marked as 'Danger', 'Caution' and 'Warning' depending on the degree of danger and the meaning is as below.



Danger

Danger: Indicates a hazardous situation that could be a result of serious injury.



Warning

Warning: Indicates a potentially hazardous situation that could be a result in light injury.



Caution

Caution: Indicates a potentially hazardous situation that could be a result in serious injury.



 **Please read this manual carefully**
before using this product

1) General safety guidelines and restrictions

* Even if the it is within the warranty period, you may be liable for any accident caused by any of the following causes.



1. Be careful of water!

This product and components are not waterproof. Don't let the water get into the product and components.

*Never use it, if the road is wet due to the rain, snow, hailstone.

*If you wash or spread water to electric devices, it can result in malfunction or fire.



2. Beware of folding and spinning parts!

If parts of the body, as a finger or hair, get caught in the spinning or folding parts of the product, this may lead to severe injuries. Please be careful.



3. No acrobatics

Stunts and jumps such as jumping and dropping are prohibited as they can cause a great impact on the product and can cause of malfunction and accidents.



4. No companion boarding

This product is intended for one adult only, so children, infants, or two people are prohibited from boarding.



5. Don't tune by yourself

Do not open or tune the electric parts (battery, controller or motor system).



6. No companion boarding

Unlicensed, driving after drinking, loading cargo on the scooter is prohibited. (More than bike or bicycle license is required) Please comply with the Road Traffic Act and related laws and regulations according to the place of use.

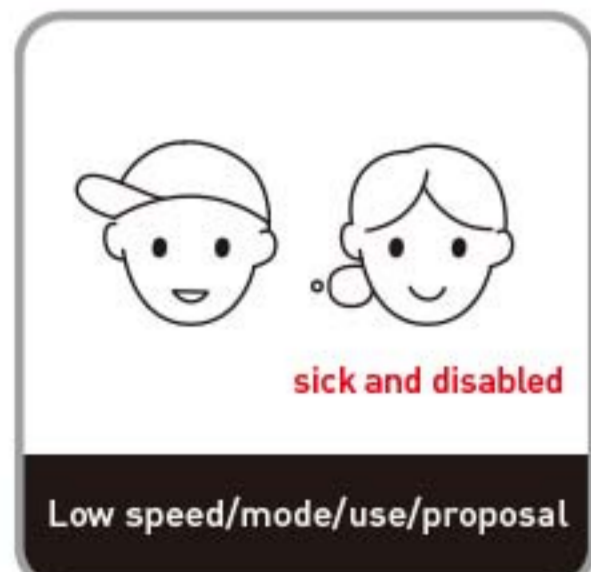

7. Beginners and seniors are encouraged to use at low speed

Beginners who are not accustomed to use the product, seniors and others should avoid high speed mode driving and recommend low speed driving. In addition, please use after practice how to ride safely in a wide place.



8. Do not sudden brake with front brake

If there is a risk of overturning, sudden deceleration should be done safely. Do not apply any unusual behaviors or artificial forces, such as stopping with your feet.



9. Do not accelerate downhill

Slow down at downhill. When reducing the speed, to prevent brake overheat, use the brakes properly to reduce the heat on the disk with proper brake use.



10. Do not drive on steep slopes

Acceptable gradeability is different for each product. Excessive hill roads exceeding the specification may cause damage to the product (parts) due to temperature cut, overcurrent or low voltage cut, which may cause the product to malfunction.



11. Safety warning when lifting the product

If the product is lifted by holding only the handle, there is a possibility that the product may be damaged due to deformation of the folding part due to load or movement of the product. When lifting the product, be sure to hold the product's body (footrest) with one hand and hold the handle with the other hand so that you do not get hurt in your back or knees.



12. Be sure to wear safety equipment

For the safety of passengers, be sure to wear a full face helmet and the other protective gear (knee, elbow, hand, upper body) and do not wear shoes such as slippers, high heels interfere with driving.

2) Precaution before driving

1. Night driving should be avoided in any case, be sure to wear helmets and other guards (knees, elbows, hands, upper body, etc.) and drive safely.
2. Select the mode that suits you and drive. In order to cope with the sudden situation, exercise to slow down to hold the brake at all times.
3. When turning left / right, slow down to avoid danger of overturning or slipping., And then slowly turn safely.
4. To go to backward, it is safe if you getting off from the product after stopping before moving.
5. It is prohibited to use in a slippery place, a crowded place, a steep slope, roads with a risk of accident, uneven road.
6. When crossing a pedestrian crossing, get off from the product for pedestrian safety.
7. Do not drive in a threat any other means of transport, such as animals, pedestrians, bicycles, motorcycles, cars, etc.
8. If you pass the speed bumps and obstacles, be sure to slow down.
9. When decelerating or braking, do not stop with using foot, but stop with using brake appropriately.
10. Be careful that there is a risk of burns due to heat from motor and brake (especially disk rotor) after driving.
11. It is prohibited to drive with all the way by holding the handle with one hand.
12. Do not ride or drive when the kick stand is down.

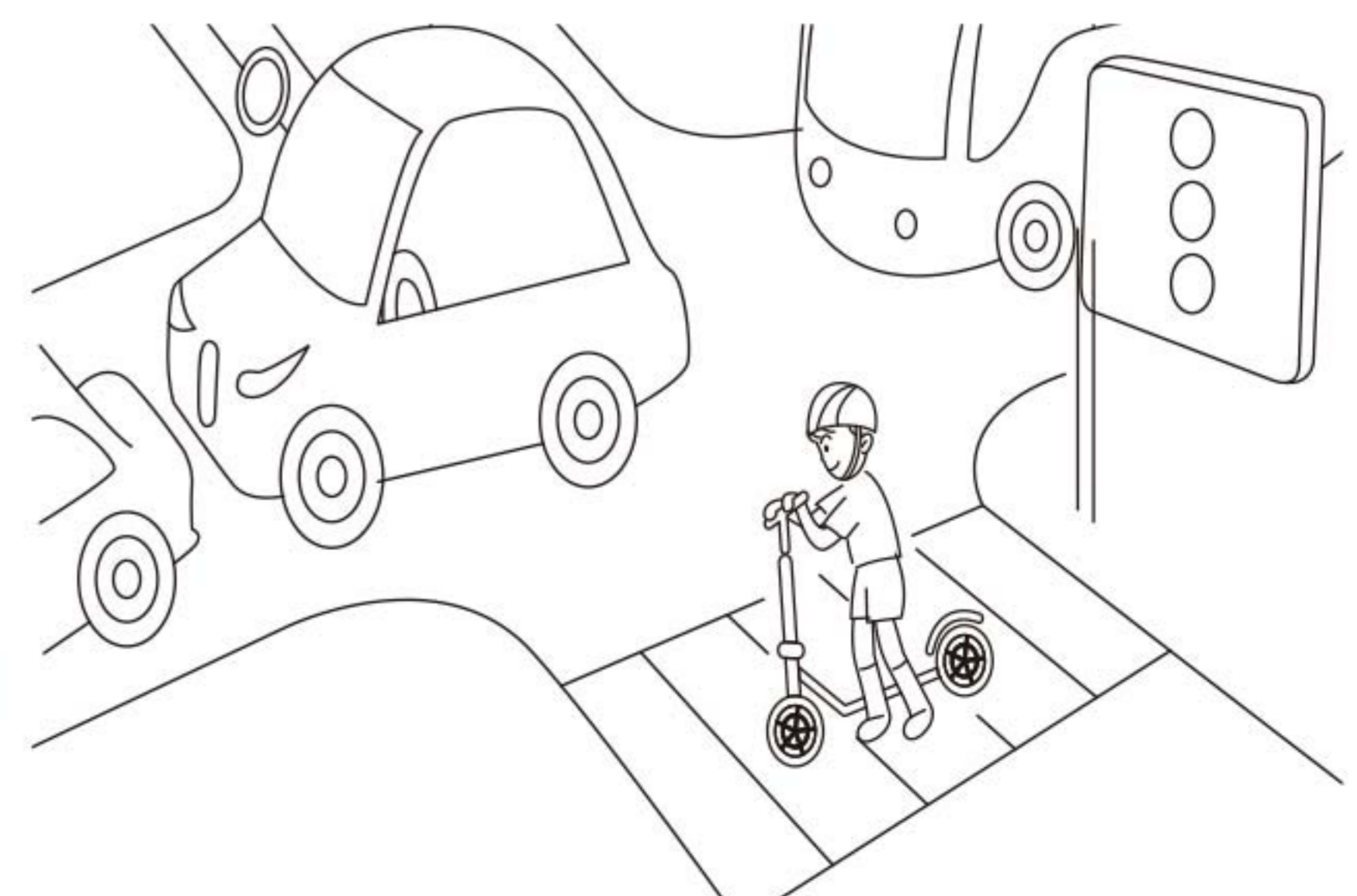

Electric wiring diagram

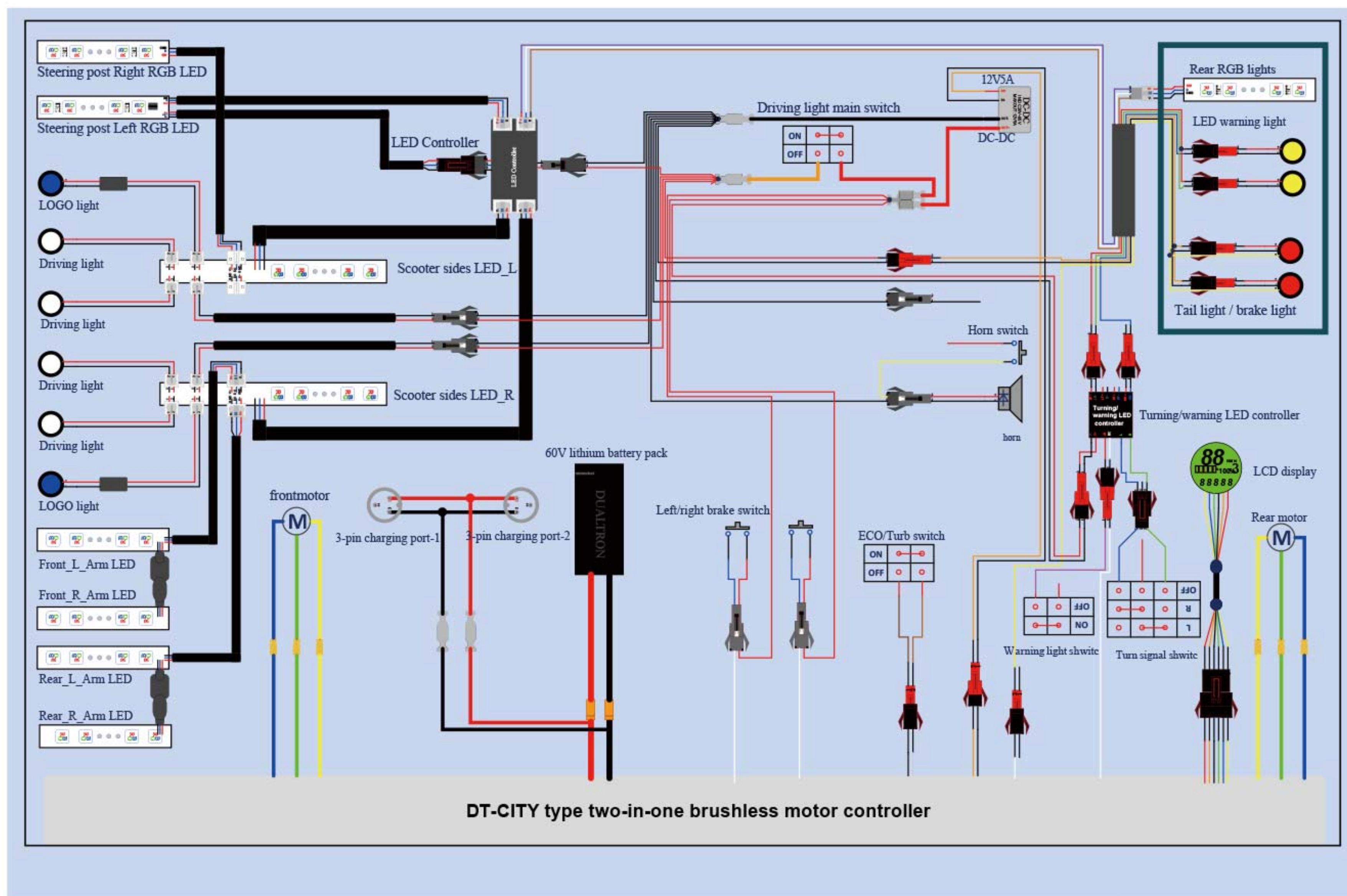

Product size



* Errors may occur depending on the measurement method.



Easy Carrying Battery

CE BAZQDC0014
 LG60V25Ah
 (For reference)

Separated battery serial number is always same as electric scooter.

Weight: 7.5 kg



The safer discharging port-XT120

(Rated current: 60A)

The joint connection is simple and convenient with anti-reverse connection function, and has better insulation.



Independent charging port

The battery is separated and this charging port is convenient for user to charge the battery separately. The charging port is same as on the scooter. (There are two other charging ports on the deck.)

Name of each part

Handle

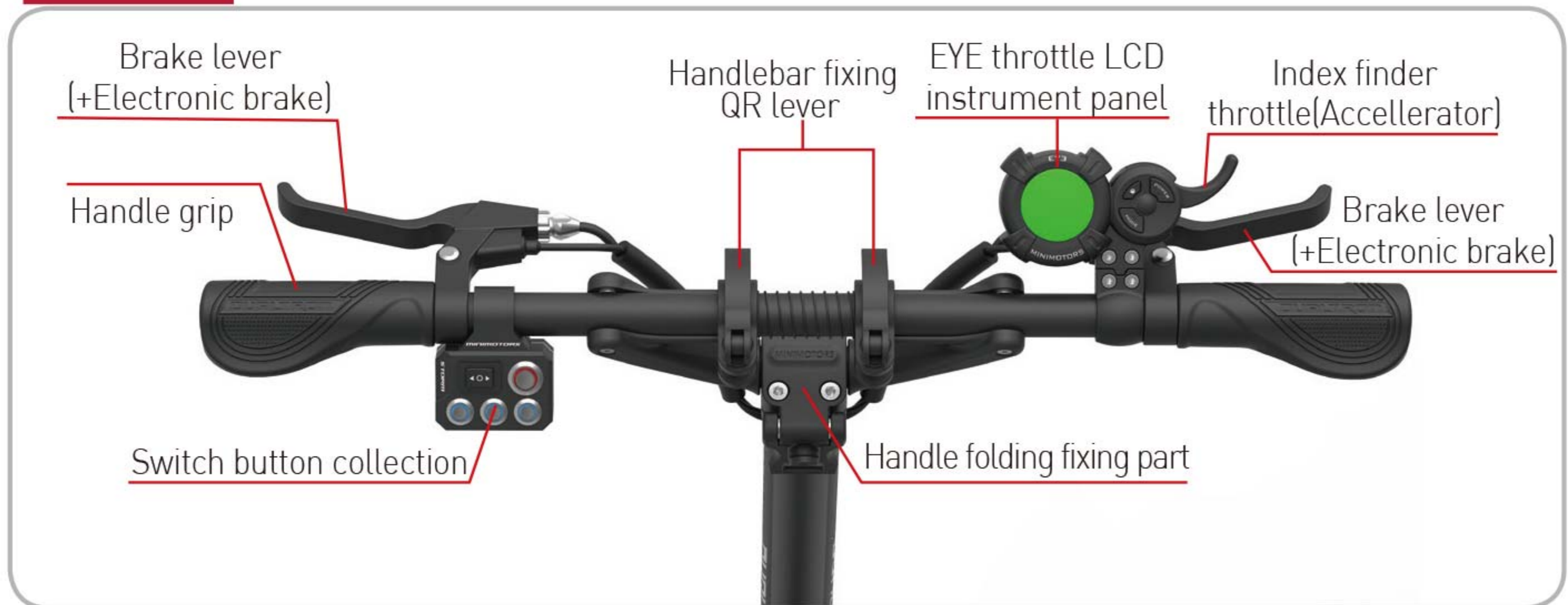

Body frame



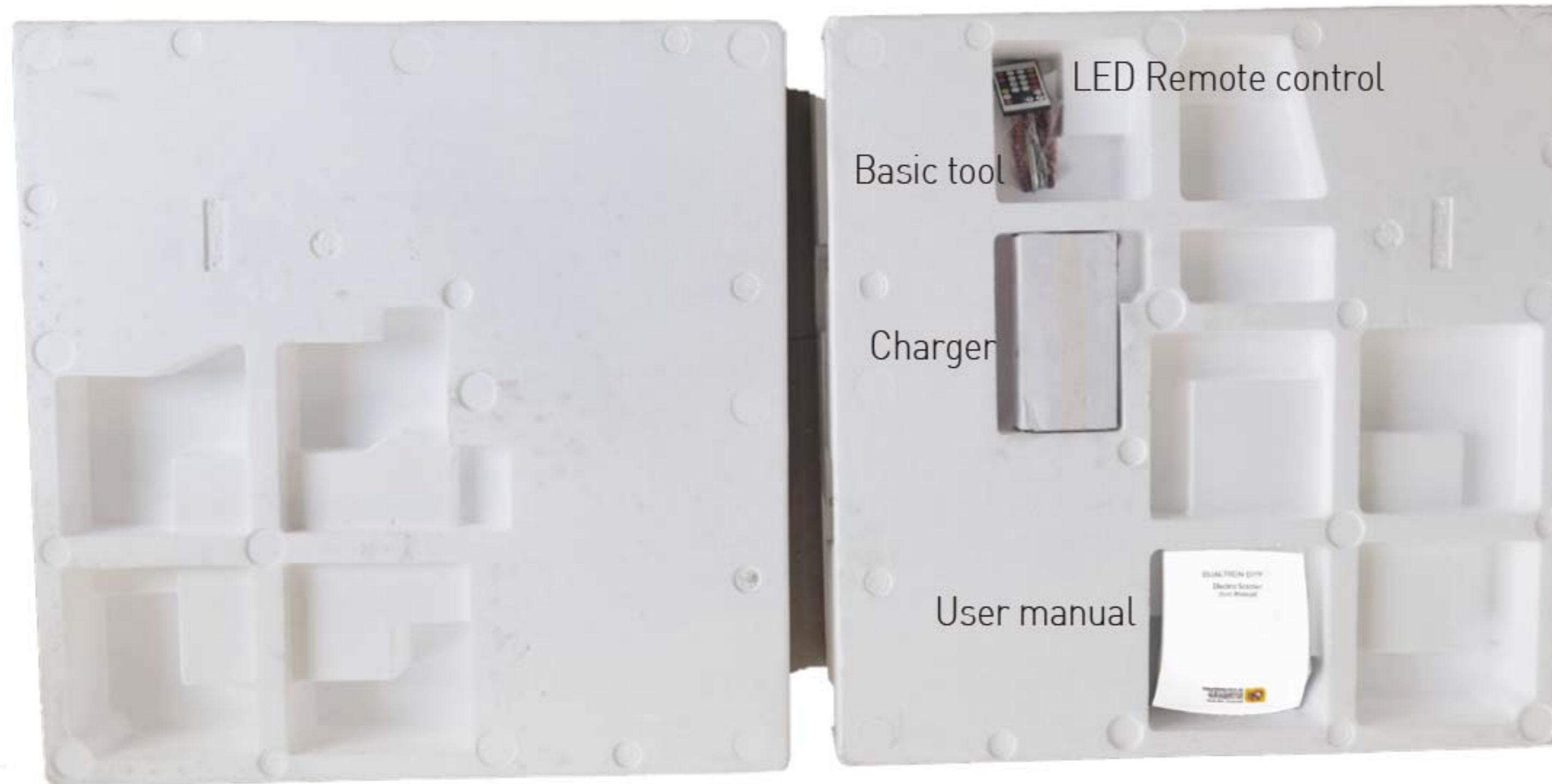

Checking the components inside of the box

Top : Default battery charger(1.75A), Default tool, User manual, Remote control
 Bottom : Body(Lithium battery included)

Ejecting the product



Do not hold the handlebar only when lifting the product from the box.
 Please be careful that the fixing slide of the folding part may be damaged, and a safety accident such as a part of the body may be caught.
 Therefore, when lifting the product, it is necessary to raise the handle bar first, and then slowly lift the body (footrest) of the product with both hands and do not damage the folding part

Make a note of the serial number.



The serial number can be used to check information such as date of purchase, warranty period, etc., and product information can be checked even if the product is lost or stolen. (May vary depending on branch office situation.)

Assembling of the instrument panel, brake



-Locate the instrument panel and tighten the fixing bolts.



-Adjust the position of the brake and tighten the fixing bolts with a 5mm hexagon wrench.

How to use the product

1) product unfolding



1. Raise the handle post(Steering tube)

Release the QR lever, raise the locking slide upwards, raise the handle post, then lower the locking slide downward.



3. Handlebar unfolding

Loosen the QR lever, pull the locking slide inward and raise the handlebar, then close the QR lever and tighten the set screw.

2. Locking the folding parts

Tighten the finishing screw properly to lock the QR lever so that the locking slide is firmly fixed in any direction, and check for looseness during use.



4. Locking the handle

Place the locking slide up to the safety line and lock it so that it is firmly fixed with the QR lever. Always check for looseness during use.

2) Remote control functions and settings

The LED remote control is infrared. Please aim at the bottom of the right LED bar.

Brightness&Light speed &Number of lamp beads control block

Multicolor light mode selection block

Light change mode selection block

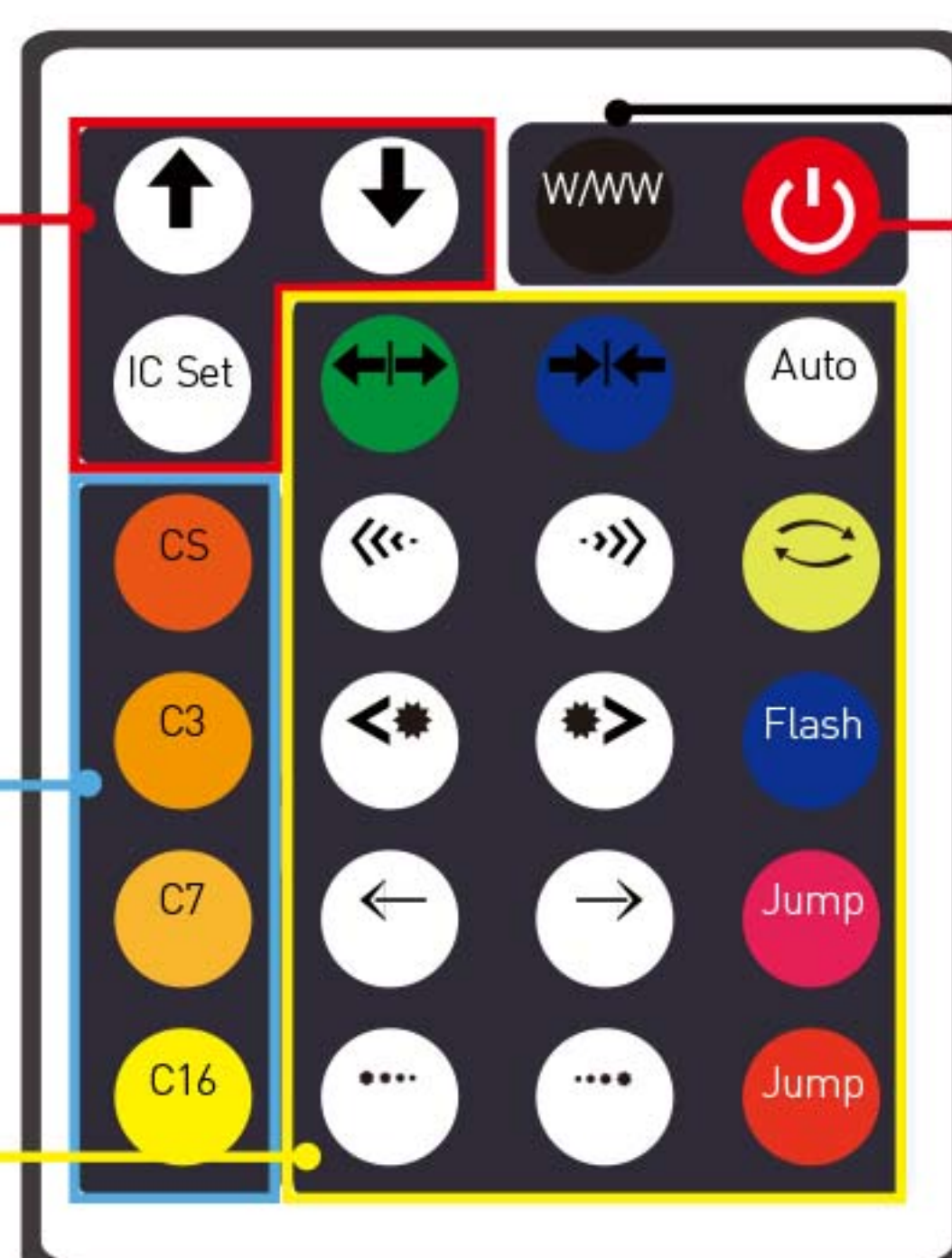

Whole white lamp

Power button

Remote receiver

The lights will only be controlled when you operate the remote towards this place



Tip

Brightness&Light speed&Number of lamp beads control block:

When single color light or whole white light is on, ↑ brighter/ ↓ darker; when the multicolor light is on, ↑ the light runs faster/ ↓ the light runs slower. When you press "IC Set" button, you can choose how many lamp beads work. Press "IC Set" button again to end the setting.

Multicolor light mode selection block:

"C3", 3 colors of light shine together; "C7", 7 colors of light shine together; "C16", 16 colors of light shine together. "CS", single color light shines.

2) How to start



Step1. Turning on the instrument panel

When turning on the product, you can start driving by turning on the power of the LCD panel. When driving is finished, turn off the LCD panel.

* The power of the instrument panel will turn off automatically after a few minutes of inactivity. At this time, the LED lamp is also turned off, so turn it off with the LED lamp button when you turn it on again.

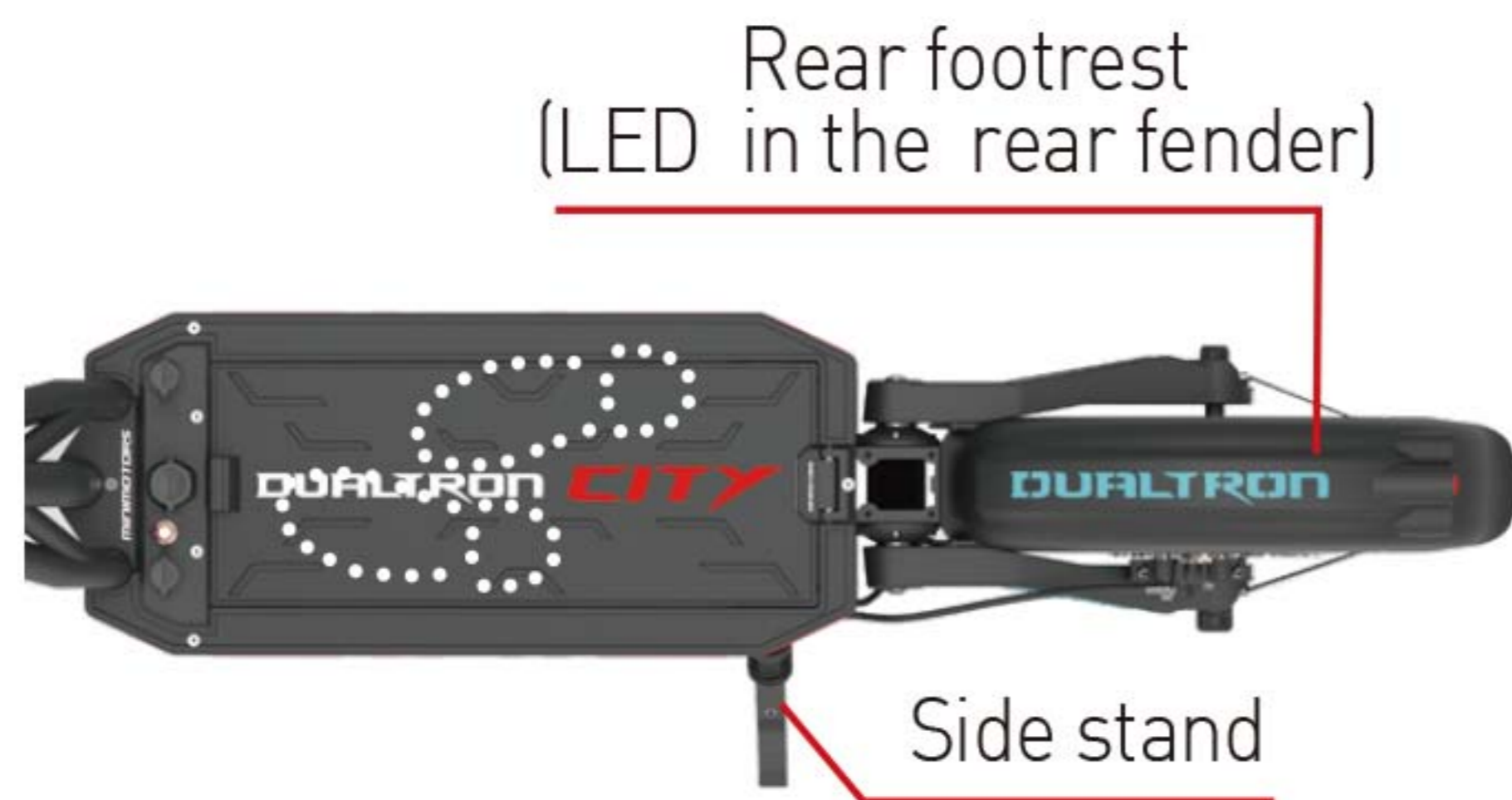

Step3. Stance for driving

After tilting the kickstand, find a stable position on the footrest and then hold the handle grip comfortably.



Step2. Setting proper parameters

Press  to choose the right gear. You also can set the start mode, cruise mode, electronic brake, and ABS function.

Tip



One button turns on/off all lights on the electric scooter.



Step4. Acceleration and deceleration

Acceleration can be performed by using the throttle of the instrument panel while driving, and the deceleration or stop can be performed by holding the brakes on the handle.



Caution

Before driving, be sure to check the folding part, the handle part, the part where the main fixing part of the product is fastened well. And check the position of the fixing slide, the QR lever locking status and the folding part fixing status.

Throttle malfunction caution

Regardless of whether the throttle is operated or not, the motor sensor may continue to operate, causing malfunctions such as sudden acceleration. In this case, holding the brake lever to cancel the operation. This phenomenon may be caused by corrosion of the throttling, immersion of the throttle, disconnection of the magnet, broken off levers, and breakage of the spring. Do not bounce the throttle lever strongly.

3) How to stop

Step1 Rear brake use

Be sure to use the rear brake first for decelerating when stopping while driving. For safe stop, it is necessary to practice slow down after deceleration with rear brake.

Step2 Front brake use

Always use the front and rear brake levers together to stop smoothly and safely after decelerating with the rear brake.



Step3 Driving mode and motor system selection

Step4 Deceleration and braking using electric brake

Set the use and strength of the electronic brake among the detailed functions of the instrument panel before driving. When the brake lever works, the electronic brake works together to increase the braking force.

Tip Check for safe braking

- For safe braking, check whether the brake lever and disc caliper connection (wire damage, external breakage, etc.) are damaged before and after driving, and check brake wear and looseness of brake inner core (Inner wire). In the case of hydraulic brakes, it is also necessary to check the oil leakage or deficiency and always check that the braking force is sufficient.
- Due to various factors such as road surface condition and speed, it may not be possible to stop when brake is operated as expected. The electronic brake and ABS functions are auxiliary functions to further increase the braking force and used. The user should understand the function and expect the operation timing when use this function.

4) Product folding



1. Fold the handlebar
Release the small QR lever, pull the locking slide inward and fold the handlebar.

2. Fold the steering post
Loosen the QR lever and raise the locking slide, then lay the steering post down.

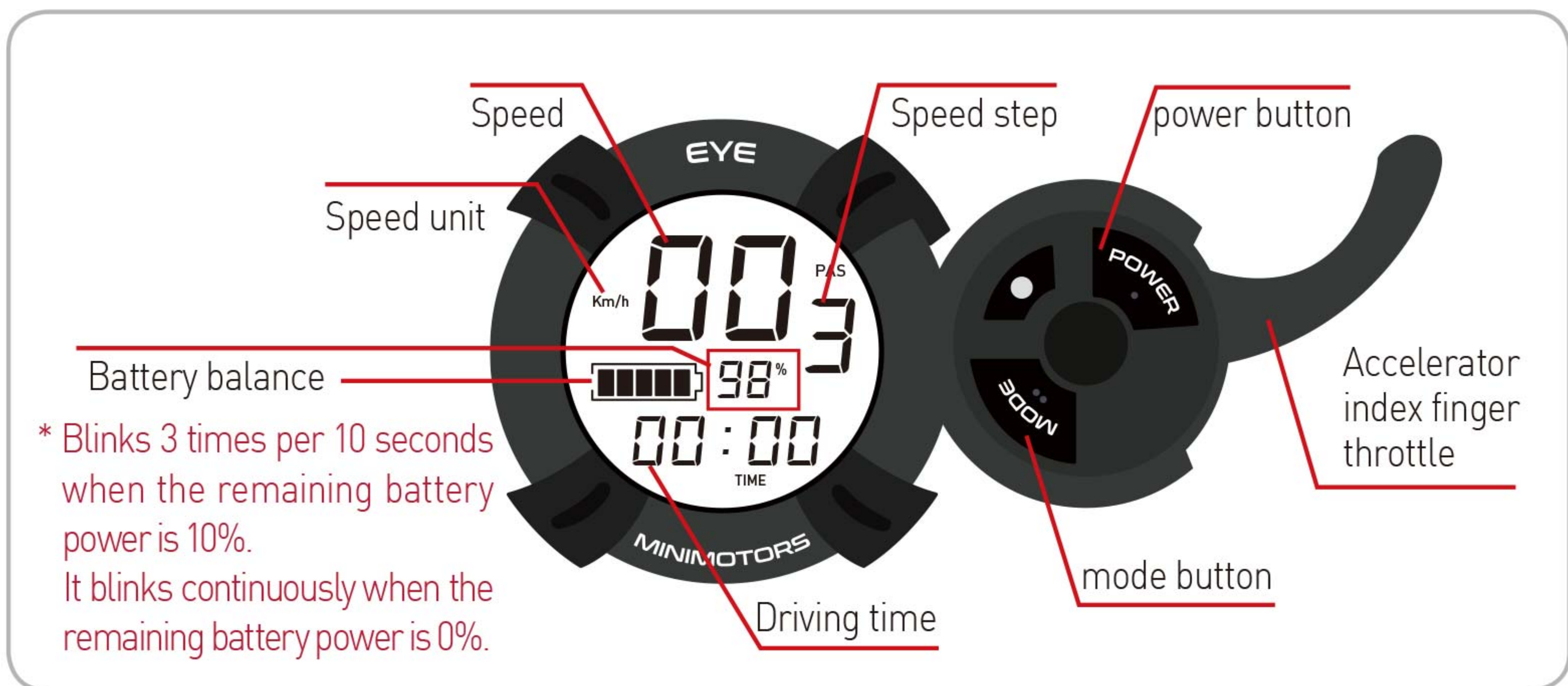

1) Speed step setting

Can adjust with button.

While the instrument panel is on, press to set the speed step. The setting is completed when the selected speed step value is selected.

2) Functions and settings for each main screen

mode Can adjust with button.



Mode	Description
TRIP	Current mileage (Press and hold button to reset to '0')
ODO	Accumulated mileage
CHA	Not use
VOL	Current voltage
TIME	Driven time

3) Instrument panel detailed function

You can change the setting mode by turning on the power of the dashboard and pressing for 2~3 seconds.

In the setting mode, press once to change the internal setting value

* If you change the default setting values P0 (15), P1 (60), P2 (15), P3 (0), correct information will not be displayed.



P0 15(Fixed)	P1 60(Fixed)	P2 15(Fixed)	P3 0(Fixed)	P4 Speed unit 0(Km/h), 1(mph)
P5 Start method 0(Acceleration start), 1(Kick start)	P6 Cruise mode 0(OFF) 1(ON)	P7 Slow start 0(Off:Power start ~5(Slow start)	P8 Max output 5~100% (User adjust)	P9 Battery save 1(MAX SAVE) 2(MID SAVE) 3(NO SAVE)
PA Electronic brake power 0(Off)~5(Powerful)	Pb LCD brightness control 0(Back light off) ~ 5(Brightest)	PC Auto off time setting 5~30 minutes	Pd ABS setting 0(OFF), 1(ON)	

4) Features of cruise mode (automatic driving)

The cruise control function allows you to maintain the driving speed automatically. Take advantage of cruise features. The advantage of being able to reduce fatigue when traveling long distances and to increase mileage of driving due to constant speed driving.

(1) The start of the cruise function

Select the Cruise function section of the dashboard as 'Settings' and set the throttle to the same Acceleration. The cruise function will start.



(2) End of cruise function

When you hold and release the brake while cruise mode is in effect, the cruise mode is automatically released.

Precautions when using the cruise function



Caution

1. In case of cruise function, please ride in a position where brake can be used immediately so that cruise function is canceled and braking is possible in preparation for safety situation while driving.
 2. It is permanently dual drive mode and can be released via throttle and brakes.
- * It is not recommended that cruise function is disabled via the throttle.

5) Setting of Electronic brake

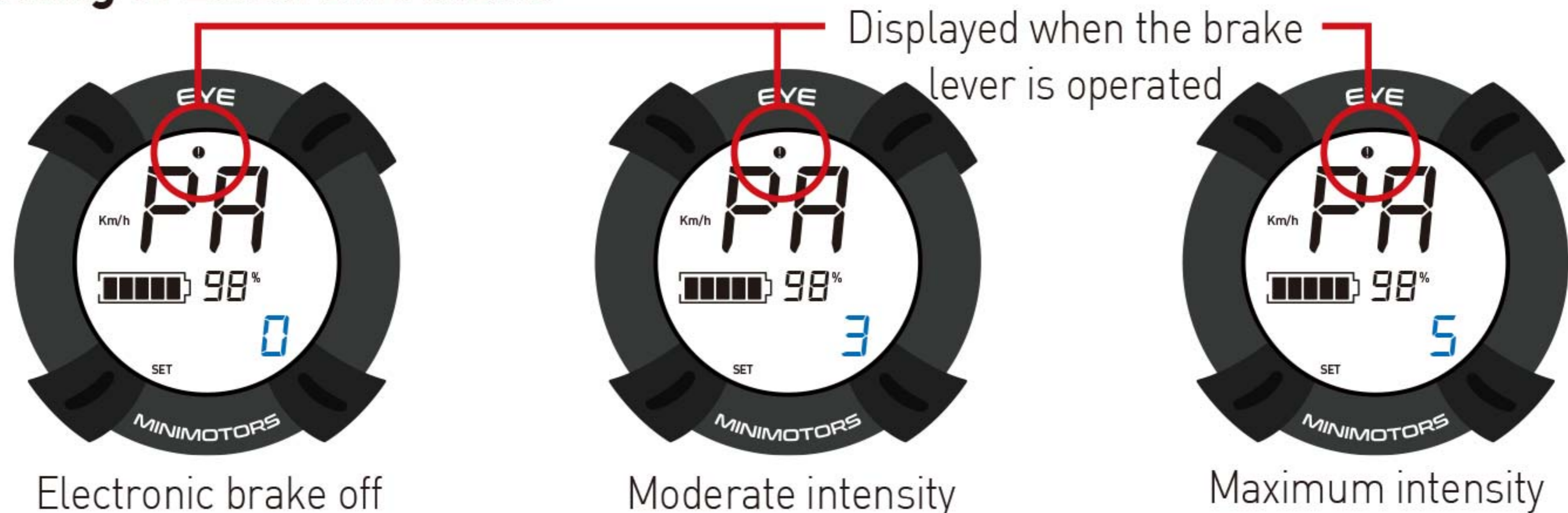



* Precautions when using electronic brake immediately after full battery charge

The electronic brakes do not operate when the battery is fully charged, so be sure to check and operate this device. When the battery runs out, the electronic brake will operate normally.

6) ABS function setting guide

All electric motorcycles are subject to sudden braking, causing the wheels to stop spinning. As a result the slip of tire causes the driver to fall down, which can cause accidents. This product is equipped with ABS brake function to hold the tire lock, enabling more secure braking.



(1) ABS function ON

Set the ABS function part Pd of the dashboard to 1.

(2) ABS function OFF

Set the ABS function part Pd of the dashboard to 0.

* Pd - When the ABS function is ON, the PA - electronic brake function is canceled.

* ABS brake is an abbreviation of Anti-Lock Brake System. It uses the principle that maximum static friction force is larger than kinetic friction, so that braking distance (distance from breaking to stopping) is shorter than that of normal brake. It has the advantage that the vehicle does not slip well when wheel is rotating and it is a brake assist system that can stop more safely without wheel lock and slip.



* Precautions when using the ABS function

ABS has the advantage of being able to stop at the shortest braking distance that can be obtained from the tires and road conditions. However, due to the principle of repeatedly holding and releasing the brake several times in a second, a lot of vibration occurs in the motor and the body. Repetitive vibration caused by this may cause frequent loosening of the motor, rim, fixing part and body fixing bolt.

7) Self-diagnosis through dashboard



Fault type	Diagnosis	Solution
②	System error	* If the error information appears, immediately stop using the product and take the scooter to the service center before use. Excessive use can result in damage to the product and safety accidents.
④	Motor error	
⑤	Accelerator error	
⑥	Controller error	
⑦ ⑧ ⑨	None	

* The number ① is displayed when the cruise function is executed at a constant speed.

* The number ③ is displayed when the brake lever is operated. (When the indicator lights, the accelerator does not operate.)

How to use the charger correctly

1) Basic charging method

1. Open the chargingport cap and connect it to the connector of the charger and connect it to the household outlet.

2. Charging status indicator

- (Red) Charging
- (Green) Charging complete



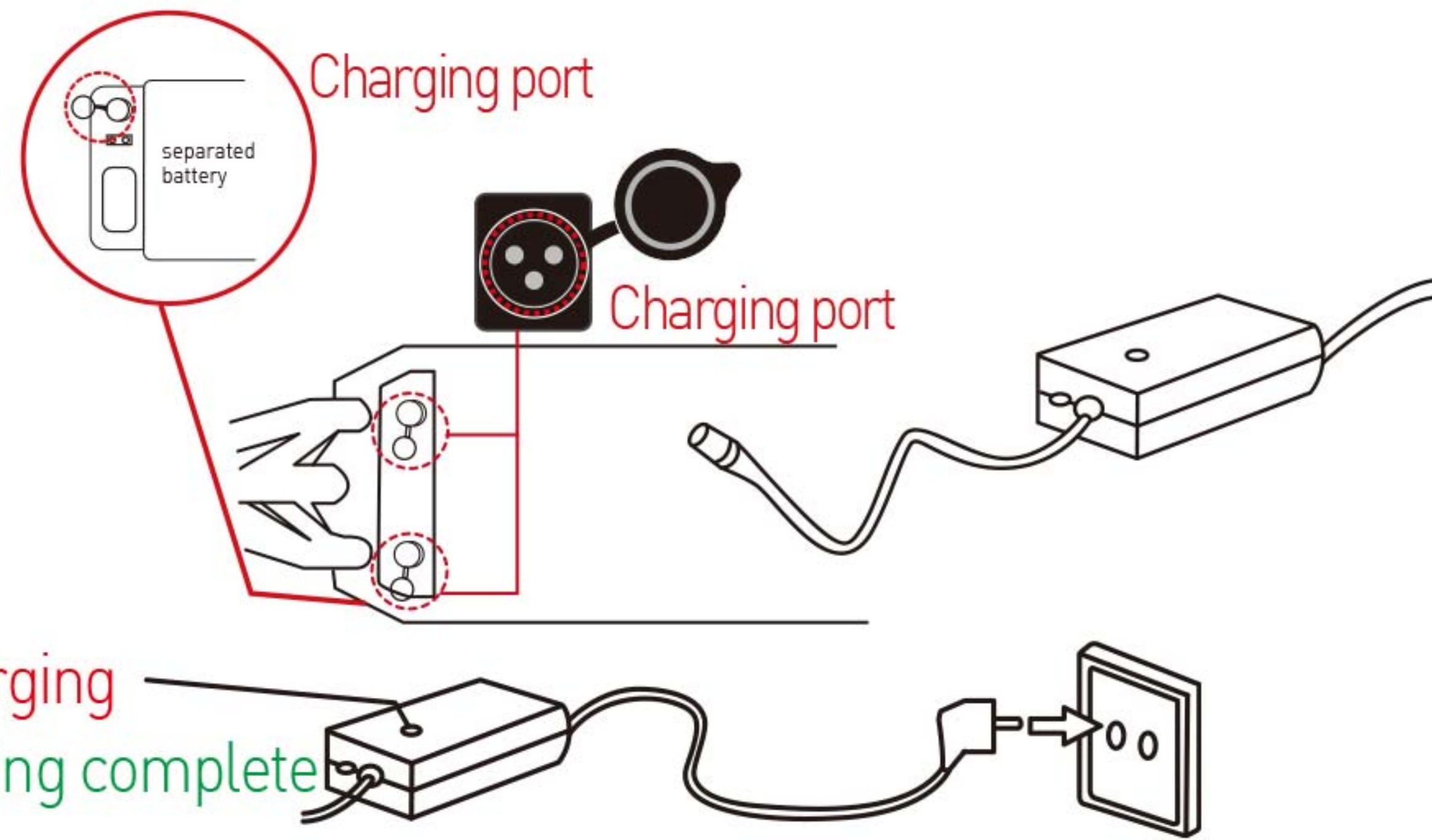

3. Be sure to close the chargingport cap when driving or storing except when charging.

4. When connecting the connector to the charging port, metallic sparks due to voltage difference may be splashed, but this is normal



2) Basic charging method

* Failure of the charger and abnormal conditions can cause electric shock and fire. Learn the correct usage and prevent safety accidents in advance.

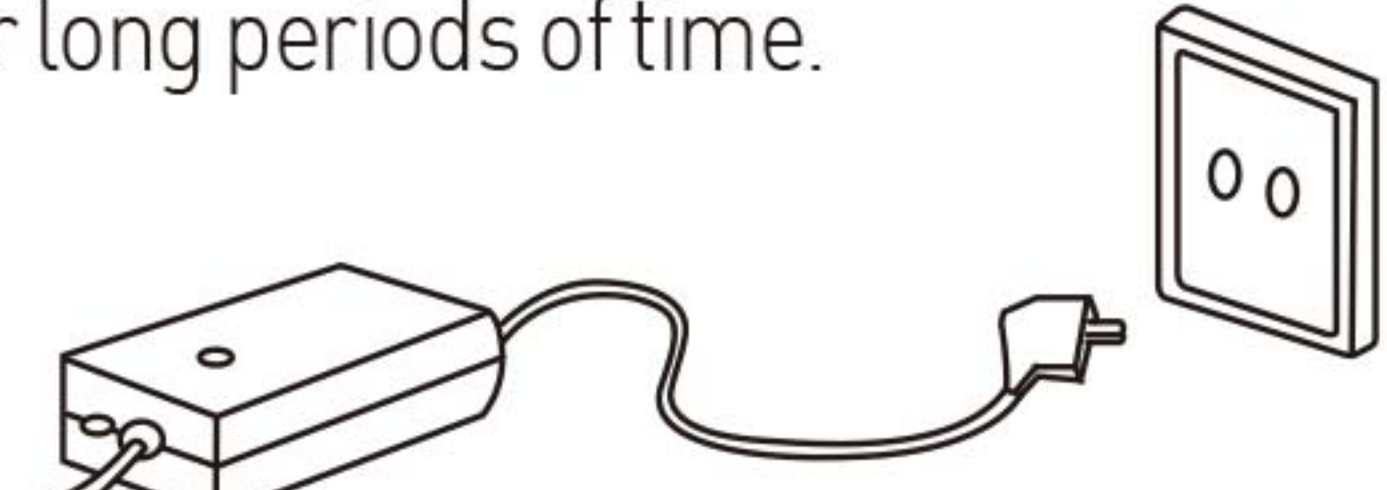
<p>1. Manufacturers and sellers are not responsible for any problems arising from any disassembly, modification, or mixing with other chargers.</p> 	<p>2. The charger is forbidden to be used in places subject to high humidity, heat, flammable materials, confined spaces, or where there is no ventilation such as in a car.</p> 
<p>3. The charger is not waterproof. It is thoroughly controlled to prevent moisture from entering the charger.</p> 	<p>4. Children and pets should not be allowed to approach the charger when they come into contact with them, as they may cause an electric shock.</p> 
<p>5. If the charger lamp does not light, charger fall, strong external shock, long time charge, or cable cover damage, discontinue use immediately and contact the service center.</p> 	<p>6. Unplug the charger when you are away from the home for long periods of time.</p> 

7. Use only genuine charger.

8. Do not insert conductors into the charging port.

9. Do not touch the plug for about 10 seconds after unplugging the charger. There is a risk of electric shock from instantaneous discharge.

10. Do not remove the terminal during charging. Charge the internal circuit of the charger and cause malfunction.

11. Do not operate the product during charging.

12. Charging terminals should be firmly contacted during charging and should not be used if terminals are corroded or damaged.

13. When disconnecting the charger from the product, it is safe to hold the terminal without holding the wire.



Warning



1) Proper Lithium battery management tips

1. Only use the charger that was supplied with your product to charge lithium-ion battery. Use of an unauthorized charger could cause serious damage to the battery and can cause fire.
2. Charge lithium-ion battery within 0-45°C and discharge within -20-60°C. Charging and discharging the battery not within the appropriate temperature may damage the lithium-ion battery.
3. Do not leave lithium-ion battery in any place exposed to direct sunlight or high temperature. Do not store it in wet places. Always store it in dry places.
4. Charge lithium-ion battery in dry, open, and well-ventilated place. Do not charge the battery near inflammable goods.
5. In the winter, bring the battery from outside to inside, temperatures changed from low to high and this may cause dew condensation. In this case, do not charge the battery immediately, but charge it after reducing temperature difference.
6. If the battery protection circuit is damaged, the battery emits an unusual smell, or the battery leaks, contact the authorized service center immediately and get technical support.
7. Put lithium-ion battery in a safe place out of the reach of children and pets.
8. Do not reverse the polarity on a battery and short-circuit. Also exposing the battery to excessive shock can result in an explosion of the battery.
9. Do not do stunts or jumps on the product on bumpy surfaces. Exposing a battery pack to excessive shock can result in fire on the battery. If there are some crashes while driving, then you should remove it out of the product to check whether the battery is working well.
10. Connecting the charger when the product is waterlogged, the risk of electric shock and fire is very high. Do not charge the battery in this case and the battery should be checked by an expert before charging.
11. Do not disassemble or incinerate lithium-ion battery. To safely dispose of lithium-ion battery, put it as industrial waste and be careful not short-circuit occurs in the terminals.
12. If the battery requires replacement after long-term use, replace it with the new one through the authorized dealer. Normally, the discharge capacity of lithium-ion battery normally decreases more than 15% after 300 times of cycle use.

Safety guidelines before driving

1) Required checking before use

1. Check throttle and handle

- Operate the accelerator throttle lever about 2 ~ 3 times to check whether it returns to the home position.
- Be careful that excessive throttle leaning and manipulation of the throttle can cause malfunction due to internal parts damage.
- Check the fastening condition and clearance of the QR lever on the handle.



2. Check brake and cable

- The brake braking force is sufficient to check the operating condition. If the braking force is significantly lowered, use it immediately after inspection and action.
- Check that the brake pad is not worn, that the cable is not loose, that the cable is not damaged, or that there is no leakage in the case of hydraulic brakes.
- If there is an unusual feeling or noise during operation, check for breakage, wear and deformation of the inner wire of the brake cable.
- Check that the bolts and nuts of the brake fixing parts are not loose, and that the disc is not deformed or damaged.



3. Check tire pressure and uniaxial condition

- Check the front and rear tires for wear and punctures and check the proper air pressure (45 to 50 psi) for the tire. When the shortage of air is shortened, the possibility of puncture increases, so check always.
- It is necessary to judge the replacement time by observing the appearance of the tire such as tire damage, uneven wear.



4. Tightening check such as folding part and handle part

- Make sure that the bolts and nuts of all parts of the product are tight and free from loosening. Check the fastening condition and clearance of the folding and fixing parts of the handle (QR lever, fixed slide, hinge center bolt, headset nut, swing arm, etc.)



Danger

* If there is a folding clearance, If there is a folding clearance, it can be adjusted with a tongue bolt. However, if you pull it too hard, it will become stiff without a gap, but it may sound 'crackling'. In this case, if you adjust the tune bolt properly, the noise disappears and the clearance is also adjusted.



* In this case, stop driving immediately.

If you encounter any of the following situations while driving, stop driving immediately and contact your nearest branch or service center for proper measures. If you provide pictures and videos to get accurate diagnosis, professional counseling is available..

- Brake braking status error
- Error messages on the instrument cluster
- When the throttle is returned to its original position
- Unusual heating of the motor
- abnormal noise is generated
- Product smoke, ignition, sour odor
- When rain or wet with water or in a similar situation
- When other driving is judged to be unreasonable



Danger

2) Maintenance and self-maintenance

Electric products can be damaged by various factors. The life span of each part varies depending on driving habits and driving environment. Parts that exceed the service life may cause accidents. Let's manage various parts and prevent safety accidents in advance.



1. Check the replacement timing of consumable parts

- ※ The rubber inside the rubber suspension is cured as the consumable parts are used, and the performance of the suspension is slightly reduced because of the reduced elasticity.
- ① The components and suspension parts of the electric scooter swing arm, tires, tubes, wheels, bearings, headset bearings, discs, brake pads, cables and folding parts, various brackets and other consumable parts requiring periodic inspection and always check.

Fatigue failure parts and maintenance parts replacement cycle		
DUALTRON STORM		
No.	Parts name	Replacement cycle / km
1	SWING ARM (LOWER HINGE)	3YEARS / 20,000
2	HIGHER HINGE	2YEARS / 10,000
3	STEERING TUBE	3YEARS / 20,000
4	HANDLE STEM	3YEARS / 20,000
5	LOCKING SLIDE	3YEARS / 20,000
6	BATTERY(INSIDE)	2YEARS / 20,000
7	Other chassis components	If the exterior is damaged or deformed



2. External damage inspection by driving environment



- ① Replace parts that may be damaged by external driving environment, such as deformation of parts, cracks due to compression, and signs of exceeding fine gold or life expectancy.
- ② If the product is exposed to strong sunlight for a long time, discoloration may occur.
- ③ In case of heavy driving such as normal jumps, slight impacts such as turning, collision, etc., when driving frequently or for a long time in a poor road condition or driving for thousands of kilometers or more, fatigue breakdown phenomena Please check and replace the parts replacement schedule for each product for safety.
- ④ Fatigue breakdown and maintenance parts may differ from the example conditions depending on the driving environment and the operating conditions. Also check parts other than the replacement cycle (maintenance parts) at all times to check for any signs of abnormality.

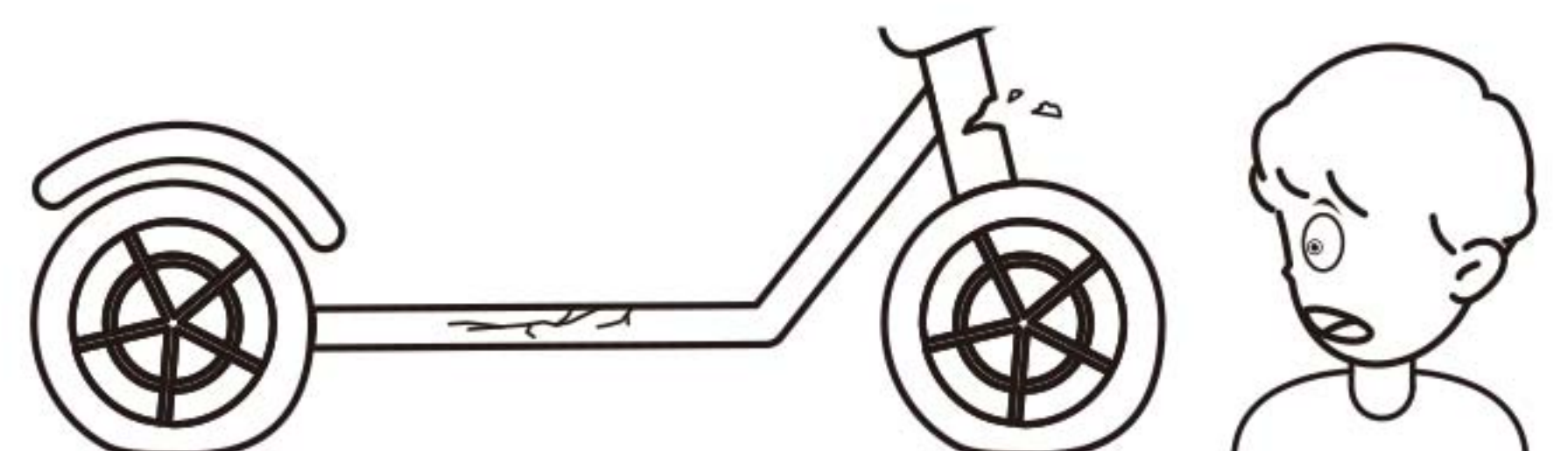

Important notice

Important notice



* Metal vibration may occur due to motor vibration, vibration of the brake disc and pad during the load section that accelerates during driving. (About 15 ~ 30Km, different for each product)

This is a phenomenon in which all revolutions (fans, automobiles, ships, etc.) are vibrating at a specific rotational frequency (rpm) rather than the product. However, if the continuous noise or metal noise is large, there is a possibility that the disk is bent and deformed.

* Please note that after running, there is a risk of burns due to the heat on the motor and brake (especially disk rotor) side.

* Be careful that the bolts of the motor, rim and motor shaft due to the ABS function may be loosened.

3) Maintenance by self-maintenance

1. Brake adjustment method

If the braking force decreases due to overheating of the oil, damage of the oil hose, loosening of the brake lever, oil leakage, etc. after using the brake for a long time on the downhill road, road, stop using and use after checking it.

2. Tire replacement method



1. After removing the nut cap, using a 18mm sleeve to take out both nuts (12mm) on the arm, the one without brake.
2. Disassemble the rear fender by using the wrenches (2.5mm and 4mm) to remove the screws.
3. Take out the wheel with tire from the motor by using the wrench 4mm to remove 6 screws.
4. Remove the wind from the tires and press the tires off the wheel.
5. Replace the tires and complete the assembly of the tires in reverse order. Tighten the assembled tire to fit the body, then tighten the screws and bolts.



Caution

- After completing the tire replacement, try a simple test run with the appropriate air pressure (45 to 50 psi).
- When puncture is occurred, it is possible to use repair by using patch seal. Please use the tire while checking and checking continuously.

Easy-wheel system



* **Completely separable hub motor design** By designing the rim and hub motor to be completely separable it is possible to replace only the rim without replacing the entire motor when the rim damages, thus improving the maintenance of the product.

3. Causes and countermeasures of disc brake noise

The disc braking method uses a disc brake method with many electric kickboards because braking power is good. However, if you get a sharp hissing sound when you hold the disc brake, dust or sand particles on the ground will spill out on the surface of the disc, causing foreign substances to be on the brake pads or disc surface, or bending due to heat or external impact. At this time, clean the inner surface of the disc by turning the wheels with a clean, dry cloth, or straightening the bent discs.



If the above measures are not taken, please visit the nearest branch and take a safety check. There may be another problem.

4. Variable rubber suspension system (patent pending) adjustment

Designed by Minimotors, the world's largest 45-step adjustable (3x3x5) rubber suspension system allows you to adjust the suspension strength with motor shaft distance (3 steps), arm angle (3 steps), and rubber cartridge replacement (5 steps).

1. Remove the front fender with a 3mm hex wrench, loosen the 18mm (motor side), 19mm (swing arm side) nut, and then loosen the nut to remove the suspension arm.
2. Adjust the motor shaft distance, rubber cartridge replacement, and arm length to the desired suspension strength.

■ Motor shaft distance (3 steps): Height adjustent (by weight)

You can adjust the height from the center.



Garage height
Intermediate stage
Garage lowered

■ Rubber Replacement (5th Stage): Replace Cartridge (Adjust height by weight)

Loosen both nuts with a wrench, loosen 3mm bolts and remove. Replace the cartridge when it is missing.

(It can be changed depending on weight and taste)



3. Align both suspension arms to the desired angle and reassemble using Loctite (screw lock).

Product Specification

Product Name	Dualtron City		
Motor	Max 4000W ; BLDC DUAL HUB MOTOR		
Battery Capacity	60V20Ah,CN	60V25Ah,LG	21700 battery cell
Product Weight	Around 41.2kg		Battery weight included
Battery Weight	Around 7.5kg		Easy charging upstairs and downstairs
Charging Time(1.75A)	11hr+	14hr+	When use 1unit 1.75A charger
Charging Time(3.5A)	5.5hr+	7hr+	When use 2unit 1.75A charger
Charging Time(8.25A)	2.4hr+	3hr+	When use 1unit fast charger(6.5A)and 1unit 1.75A charger
Max Speed	70km/h		75kg,66.4V,full charging,flat road. *Max mileage could be shorter depending on the driving environment.
Mileage(ECO)	70km	90km	
Gradeability	Around 37%(Around 20°)		Gradeability depends on the weight of rider,road condition battery condition,temperature.
Max Load	120kg		Max 120kg is recommended
Folding	Handle post two touch double folding		Double clamp design
Unfolded Size	1570x615x1270mm		Length x Width x Height
Folded Size	1570 x 256 x750mm		Length x Width x Height
Instrument Panel	EYE throttle is applied as the default option.(Battery level, TRIP, ODO, Time, Speed display and mode change.)		Cruise / Electronic brake / Auto save function / ABS
Controller	30A X 2 Power controller		Build in tail / Waterproof / Heat sink / Foot rest
Light	Arms&Handlebar sides LED lights Dual LED headlight&taillight Brake light,turning light		DC to DC converter is built in (12V 5A output) Handlebar Switch Collection:Turning switch Lights switch/Horn switch/Dual switch warning switch/RGB lights(remote control)
Horn	Hidden horn built-in		
Suspension	45-step adjustable new rubber suspension 9 step variable suspension system + 5 kinds of rubber cartridge replaceable design		Soft,medium soft,hard,medium hard cartridge is optional/Patent
Brake	Hydraulic brake+160mm disk		Common use for front and rear wheel
Tire	15 inch on road tire		Tire width 90mm(Proper air pressure 50psi)
Product material	Frame and handle: Aviation aluminum forging alloy, 6082-T6, UltralightCarbon Fibre, Shaft: SCM440, Covers: Polypropylene		

*The specification can be changed by manufacturer without notice to improve the quality and safety for users.

*The distance can be affected by loaded weight, wind direct (wind speed), road condition, slope and tire condition.

MEMO

DUALTRON CITY

Electric Scooter User Manual

Zhejiang Minimotors Bike Co., Ltd.

No.1, Baolong road, Lanjiang Street,
Lanxi Economic development zone,
Jinhua city, Zhejiang province, China

www.dual-tron.com



Since 1999