

SCOPE COVER

MEASUREMENT GUIDE



BORN FROM EXPERIENCE™

P. 3

3 WAYS TO MEASURE
YOUR SCOPE

P. 4-5

TYPES OF BUTLER CREEK® SCOPE COVERS

P. 6-9

MEASURE BY
MODEL# CHARTS

P. 10-11

SCOPE SIZE
MEASUREMENT CHARTS

There are three simple ways to measure your scope to find the right fit: Using calipers, a ruler or our scope model# chart (Pages 6-9).

1. MEASURE BY CALIPERS

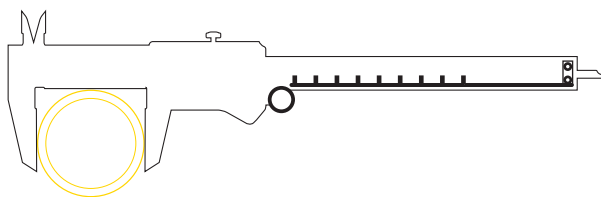

Use the calipers to measure the outside edge of the scope housing on both the eye piece and objective. You can measure in inches or millimeters.

Use your measurements and select the style of cover you want on the Butler Creek® Measurement Chart on pages 10-11. Find the size that is closest to your measurements to get the best-fitting scope cover.

2. MEASURE BY RULER

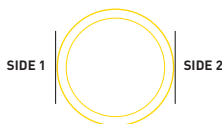

Stand your scope up on a piece of paper. Mark a line on each side of both the eyepiece & objective lenses.

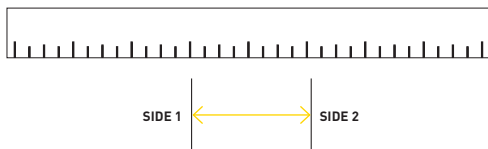

Use a ruler to measure the distance between the lines of each lens to determine the size of scope cover you need.

Use your measurements and select the style of cover you want on the Butler Creek® Measurement Chart on pages 10-11. Find the size that is closest to your measurements to get the best-fitting scope cover.

3. MEASURE BY MODEL CHART

MODEL# CHARTS ARE LOCATED ON PAGES 6-9.

*If your scope falls between two sizes, choose the smaller size for the best fit. A piece of electrical tape around the eyepiece or objective can also help you achieve the perfect fit.

FLIP-OPEN®

- Waterproof & airtight
- Custom fit for most scopes
- Silent, "instant action" lids pop open at the touch of a thumb
- Performs from -40° F to 120° F



MULTIFLEX®

- Flexible collar provides tight fit for multiple scope sizes
- Waterproof & airtight
- Custom fit for most scopes
- Silent, "instant action" lids pop open at the touch of a thumb
- Performs from -40° F to 120° F



BLIZZARD™

- Ideal for extreme weather conditions – snow, rain, dust/sand
- Creates weather-resistant seal
- Best light transmission of any see-through cover
- Works for both objective or eye lens

**BIKINI®**

- Moisture & dustproof seal
- One-piece design
- Quick clearing
- The Bikini® cover fits all sizes and makes of riflescopes (up to 62mm)

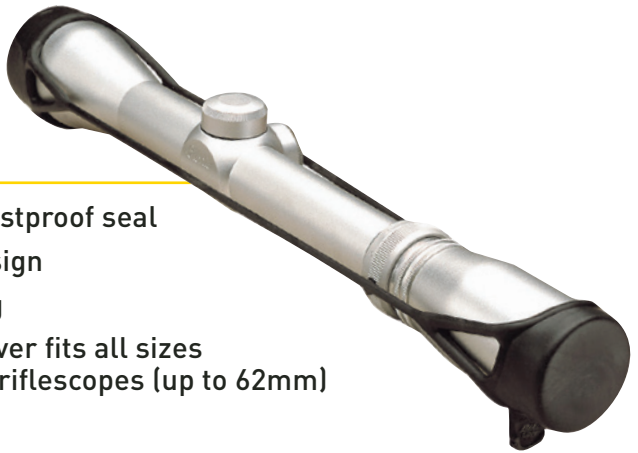
**TINI BIKINI®**

- Moisture & dustproof seal
- One-piece design
- Quick clearing
- The Tini Bikini® cover fits all sizes and makes of pistols and red dots (up to 38.1mm)

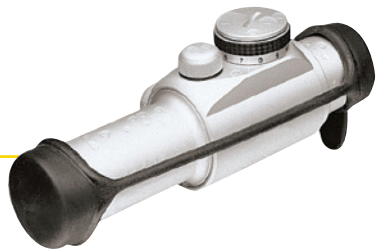

FLIP-OPEN® – OBJECTIVE

Flip-Open Scope Covers have specific models for both the objective and eyepiece of your scope, so each lens must be sized separately.

Place the OBJECTIVE of your scope on the baseline of Set A and Set B to determine the model number that fits your scope.

OBJECTIVE: SET A

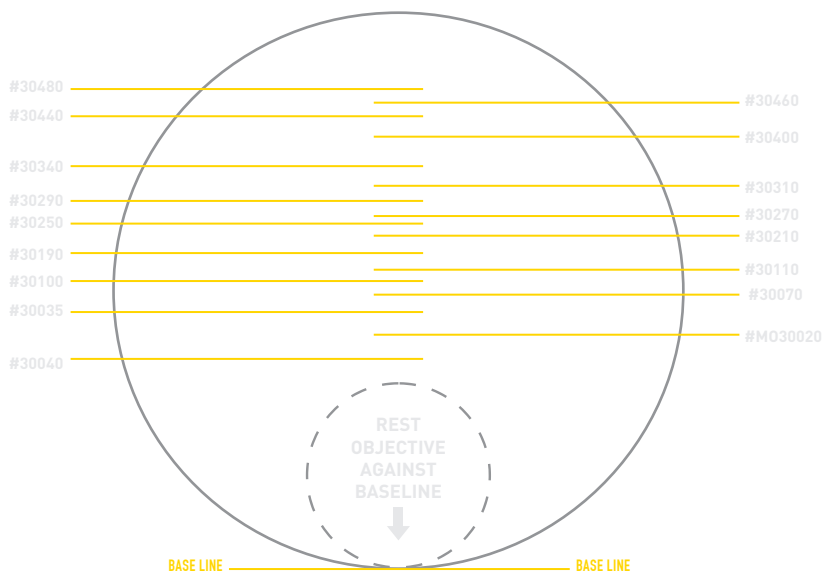

OBJECTIVE: SET B

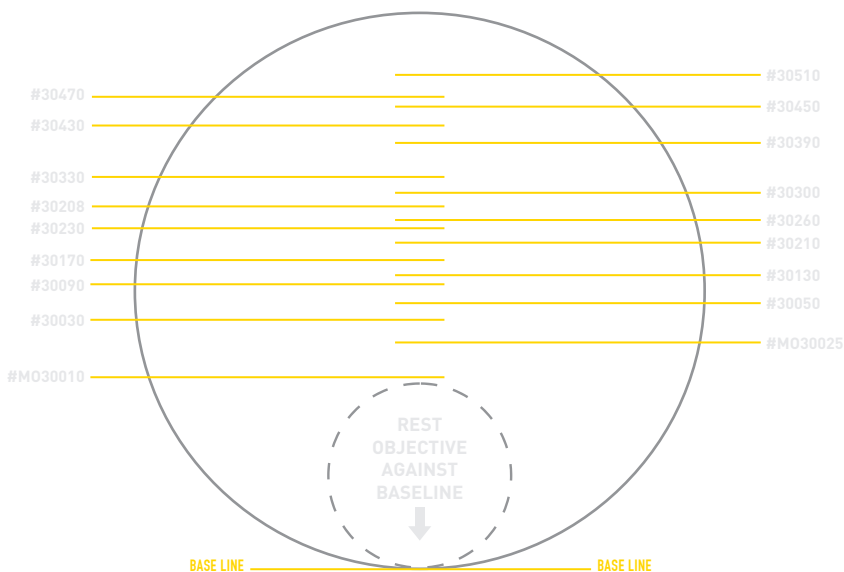

FLIP-OPEN® – EYEPIECE

Place the EYEPIECE of your scope on the baseline of Set A and Set B to determine the model number that fits your scope.

EYEPIECE: SET A

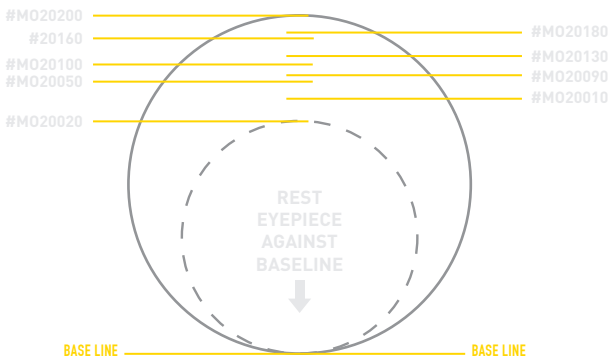

EYEPIECE: SET B

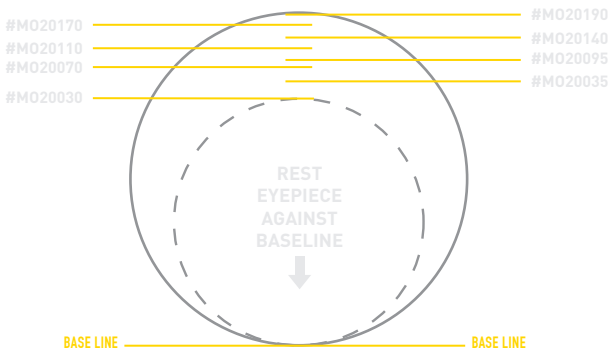

MULTIFLEX® – OBJECTIVE & EYEPIECE

MultiFlex® Scope Covers have specific models for both the objective and eyepiece of your scope, so each lens must be sized separately.

Place the OBJECTIVE and the EYEPIECE on the baseline of their respective charts to determine the model number that fits your scope.

If the top of your objective or eyepiece is in a yellow bar, use that model. If not, we do not have a MultiFlex® Scope Cover that fits your optic. Please try our Flip-Open® Scope Covers, which come in a wider array of sizes.

OBJECTIVE

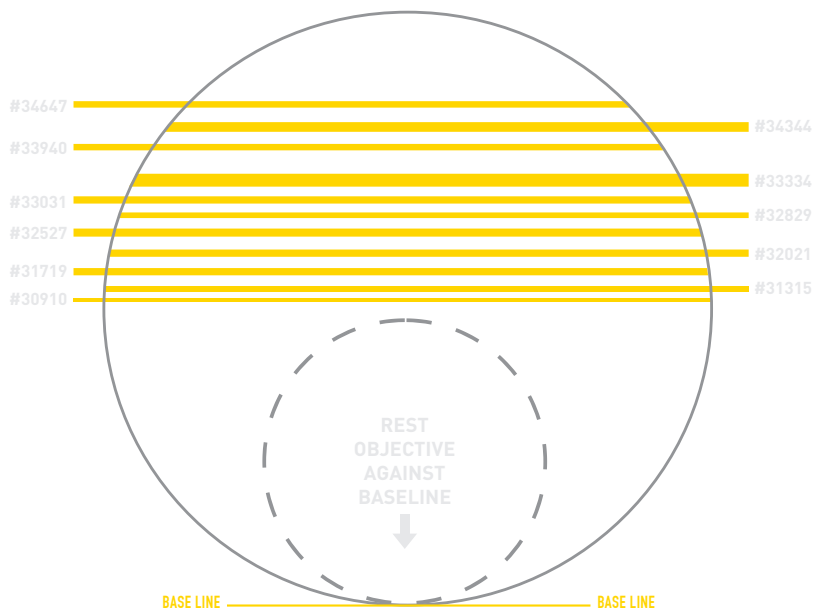

EYEPIECE

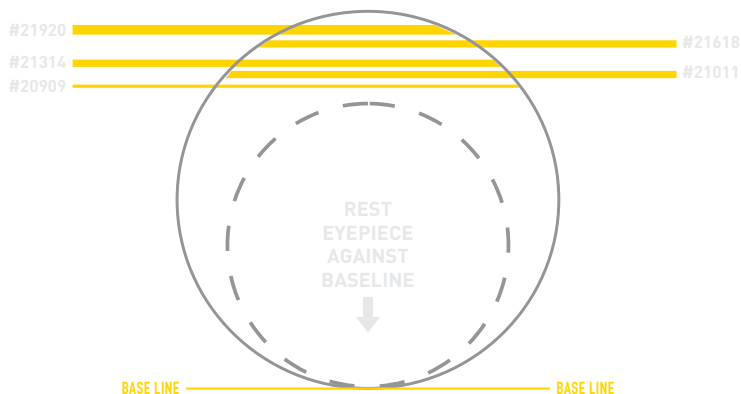

****Multi-Flex® Scope Covers have flexible collars and are designed to fit a wide array of riflescopes. The wide yellow lines show the range of sizes each model fits.**

BLIZZARD™ – OBJECTIVE & EYEPIECE

Blizzard™ Scope Covers are designed specifically for adverse weather conditions. They are designed to fit both the objective and eyepiece of your optic.

Place both the EYEPIECE and OBJECTIVE of your riflescope on the base line. Choose the model closest to the top of the optic.

If the top of your objective or eyepiece is not in a yellow bar, we don't have a Blizzard™ Scope Cover that fits your optic. Please try our Flip-Open® and MultiFlex® Scope Covers, which come in a wider array of sizes.

OBJECTIVE & EYEPIECE

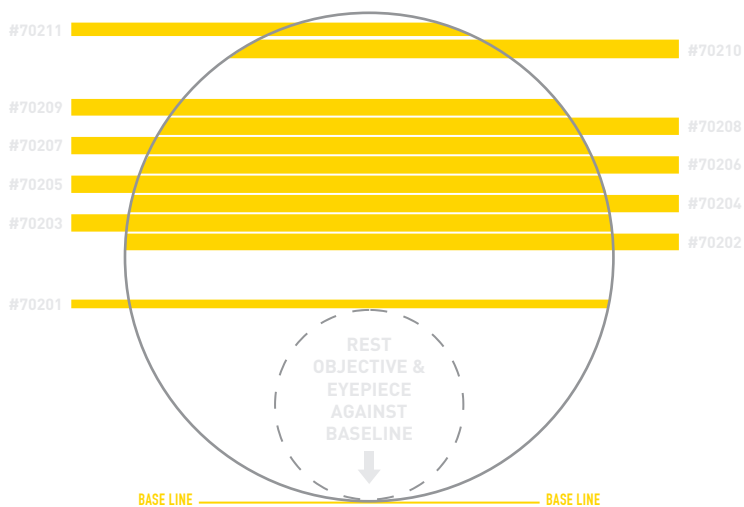

FLIP-OPEN®

EYEPIECE			OBJECTIVE		
Inches	(mm)	Model#	Inches	(mm)	Model#
1.225	31.10	MO20020	1.000	25.40	MO30010
1.300	33.00	MO20030	1.095	27.80	30040
1.341	34.10	MO20010	1.181	30.00	MO30025
1.388	35.30	MO20035	1.221	31.00	MO30020
1.432	36.40	MO20050	1.300	33.00	30030
1.457	37.00	MO20070	1.340	34.00	30035
1.468	37.30	MO20090	1.387	35.20	30050
1.485	37.70	MO20095	1.429	36.30	30070
1.516	38.50	MO20100	1.485	37.70	30090
1.550	39.40	MO20110	1.500	38.10	30100
1.570	39.90	MO20130	1.54x1.34	39.1x34.0	30110
1.605	40.80	MO20140	1.76x1.53	44.7x38.9	30120
1.66x1.45	42.2x36.8	MO20150	1.530	38.90	30130
1.660	42.20	20160	1.558	39.60	30150
1.675	42.50	MO20170	1.612	40.90	30170
1.700	43.20	MO20180	1.646	41.80	30190
1.730	43.90	MO20190	1.700	43.20	30200
1.775	45.10	MO20200	1.735	44.10	30210
1.70x1.42	43.2x36.1	MO20210	1.760	44.70	30230
			1.800	45.70	30250
			1.820	46.20	30260
			1.840	46.70	30270
			1.890	48.00	30280
			1.919	48.70	30290
			1.960	49.80	30300
			1.998	50.70	30310
			2.043	51.90	30330
			2.100	53.30	30340
			2.220	56.40	30390
			2.250	57.20	30400
			2.310	58.70	30430
			2.360	59.90	30440
			2.410	61.20	30450
			2.430	61.70	30460
			2.461	62.50	30470
			2.500	63.50	30480
			2.575	65.40	30510

MULTIFLEX®

EYEPIECE			OBJECTIVE		
Inches	(mm)	Model#	Inches	(mm)	Model#
1.468-1.485	37.30-37.70	20909	1.450-1.500	37.70-38.10	30910
1.516-1.550	38.50-39.40	21011	1.530-1.558	38.90-39.60	31315
1.570-1.605	39.90-40.80	21314	1.612-1.646	40.90-41.80	31719
1.660-1.700	42.30-43.20	21618	1.700-1.735	43.20-44.10	32021
1.730-1.775	43.90-45.10	21920	1.800-1.840	45.70-46.70	32527
			1.890-1.919	48.00-48.70	32829
			1.960-1.998	49.80-50.70	33031
			2.043-2.100	51.90-53.50	33334
			2.220-2.250	56.40-57.20	33940
			2.310-2.360	58.70-59.90	34344
			2.430-2.461	61.70-62.50	34647

BLIZZARD™**OBJECTIVE & EYEPIECE**

Inches	(mm)	Model#
1.00-1.05	25.400-26.670	70201
1.30-1.39	33.020-35.306	70202
1.40-1.49	35.560-37.846	70203
1.50-1.59	38.100-40.386	70204
1.60-1.69	40.640-42.926	70205
1.70-1.79	43.180-45.466	70206
1.80-1.89	45.720-48.006	70207
1.90-1.99	48.260-50.546	70208
2.00-2.10	50.800-53.340	70209
2.30-2.40	58.420-60.960	70210
2.43-2.50	61.722-63.500	70211

BIKINI® & TINI BIKINI®**OBJECTIVE & EYEPIECE**

BIKINI®: fits riflescopes with an outside objective diameter of 62mm or less.

TINI BIKINI®: fits all pistol and red dot scopes with an outside objective diameter of 38.1 mm or less.

9200 Cody
Overland Park, KS 66214
Phone (800) 423-3537
© 2017 | Lit# 9107020907

BUTLERCREEK.COM