



AFINIA 3D™



H800 3D Printer

Version 1.4

TABLE OF CONTENTS

Safety Precautions	5
Protecting the Printer	5
Overview	6
Unpacking the Afinia H800 3D Printer	8
The Print Head	9
The Control Buttons	9
Installing the Afinia H800 3D Printer	10
Driver and Software Installation	10
Installing the Printer	10
Loading the Filament	11
Getting Ready to Print	12
Starting the Afinia 3D Program	12
Initializing the Printer	12
Preparing the Platform	13
Leveling the Print Platform	14
Platform Calibration	15
Automatic Platform Calibration	15
Manual Platform Calibration	16
Calibrating the Nozzle Height	17
Other Maintenance Options	18
Printing with the H800 3D Printer	20
Loading a 3D Model	20
View Options	22
Model transformations	22
Placing Models onto the Build Platform	24
Print Setup Options	25
Print Settings	25
Part Settings	25
Printing	29
Print Options	29
Save as Project	31
Model Removal	32
Removing Support Material	33
Maintenance	34
Changing the Filament	34
Cleaning the Nozzle	35
Removing / Changing the Nozzle	35
Cleaning the Extruder Gear	36
Cleaning the Platform	37
Lubrication of Extruder Rails	37
Changing the HEPA Filter	37
Spare parts	37
Vertical Calibration	37
Tips & Tricks	39
Status Indicator	41
Changing Languages	41
Updating the Printer ROM	42
Troubleshooting	42
Specifications	45
Technical Support	46
Acronyms and Jargon	46

Afinia 1-Year Limited Warranty

Below is the one-year limited warranty included with this Afinia product. Afinia prides itself on its outstanding product line and its technical support. If for some reason, your product fails, Afinia, a division of Microboards Technology, LLC, stands behind its warranties and assures you the best service possible in a quick and timely manner.

Afinia warrants to the original purchaser that this product is free from defects in material and workmanship. Afinia will for one year, at its option, repair or replace at no charge for parts and labor from the date you purchased the product from an authorized Afinia reseller. Nozzles and Cell/Perf Boards are warranted for ninety (90) days.

- Warranty registration must be completed within 30 days of receipt of the product in order to validate the warranty.
- Afinia, a division of Microboards Technology, LLC, reserves the right to determine the validity of all warranty claims.
- Warranty is void if the product serial number has been altered or removed.
- Warranty is void if the product has been misused or damaged or if evidence is present that the product was altered, modified, or serviced by unauthorized service people.

The above stated warranty is exclusive and replaces all other warranties, express or implied, including those of merchantability and fitness for a particular purpose. Afinia, a division of Microboards Technology, LLC, will not be liable for any other damages or loss, including incidental or consequential damages and loss of profits or revenues from whatever cause, including breach of warranty or negligence.

This product has been thoroughly tested and inspected at the factory prior to shipment. Nevertheless, inspect your product completely for any damage or loss of parts that may have occurred during shipment. Notify the delivering carrier promptly if damage claims are to be filed.

Afinia reserves the right to modify or update its product without obligation to replace any equipment delivered prior to any such change.

To register your warranty, please visit www.afia.com/register

FCC ID: 026-H800

This device complies with Part 15 of the FCC Rules. Operation is subject to the following two conditions: (1) this device may not cause harmful interference, and (2) this device must accept any interference received, including interference that may cause undesired operation.

Changes or modifications not expressly approved by the party responsible for compliance could void the user's authority to operate the equipment.

NOTE: This equipment has been tested and found to comply with the limits for a Class B digital device, pursuant to Part 15 of the FCC Rules. These limits are designed to provide reasonable protection against harmful interference in a residential installation. This equipment generates, uses, and can radiate radio frequency energy and, if not installed and used in accordance with the instructions, may cause harmful interference to radio communications. However, there is no guarantee that interference will not occur in a particular installation. If this equipment does cause harmful interference to radio or television reception, which can be determined by turning the equipment off and on, the user is encouraged to try to correct the interference by one or more of the following measures:





- Reorient or relocate the receiving antenna.
- Increase the separation between the equipment and receiver.
- Connect the equipment into an outlet on a circuit different from that to which the receiver is connected.
- Consult the dealer or an experienced radio/TV technician for help.

Safety Precautions

Please read this section carefully before using the printer.

- The printer can only be used with the power adapters supplied by this company, or the product may be damaged, with a risk of fire.
- To avoid burning or model deformation, do not touch the model, nozzle, or the platform by hand or any other part of the body while the printer is working or immediately after it has finished printing.
- Protective glasses should always be worn when removing support material, especially PLA.
- There is a slight smell from ABS when it is being extruded. A well-ventilated room is recommended; however when printing, keep the printer away from any drafts as this can affect the warping of ABS prints.
- When ABS is burnt it releases toxic fumes. Never set the nozzle temperature high enough to burn the material.

The following classifications are used in this manual:

	CAUTION: Indicates a potentially hazardous situation which, if not avoided, may result in minor or moderate injury.
	WARNING: Indicates a potentially hazardous situation which, if not avoided, may result in serious injury.
	GLOVES: When performing certain maintenance procedures, the machine may be hot and gloves are required to avoid burns.
	SAFETY GLASSES: Wear safety glasses to avoid injury to your eyes.

Protecting the Printer

- The printer must not be exposed to water or rain, or damage may occur.
- Do not shut down the Afinia H800 3D System or pull out the USB cable when loading a digital model or the model data may be lost.
- When using the “Extrude” function, keep at least 50mm between the nozzle and the platform. If too close, the nozzle may get blocked.
- The printer is designed to work properly at an ambient temperature of between 60°F and 85°F and humidity of between 20% and 50%. Operating outside these limits may result in low quality models.

Overview

The Afinia H800 was designed specifically for educators and professionals looking for fast, hassle-free 3D printing with exceptional quality. The Afinia H800 boasts a host of features, from Smart Support, user-friendly software and automatic leveling, to paper-thin layer HD resolution with a heated build platform. Everything about this printer is geared towards creating high standard professional 3D models.

Print a working bearing in one design, make a part for a dishwasher or just unleash your creativity and bring your designs to life with your new Afinia H800.



The Afinia 3D software sends the print data from a Mac or PC to the Printer over a single USB cable. The Extruder delivers the Filament from the Spool into the Nozzle, which heats the filament to printing temperature and deposits it on the Platform.

The Afinia H800 with HEPA filter is packed with advanced technologies in a stylish and robust design.

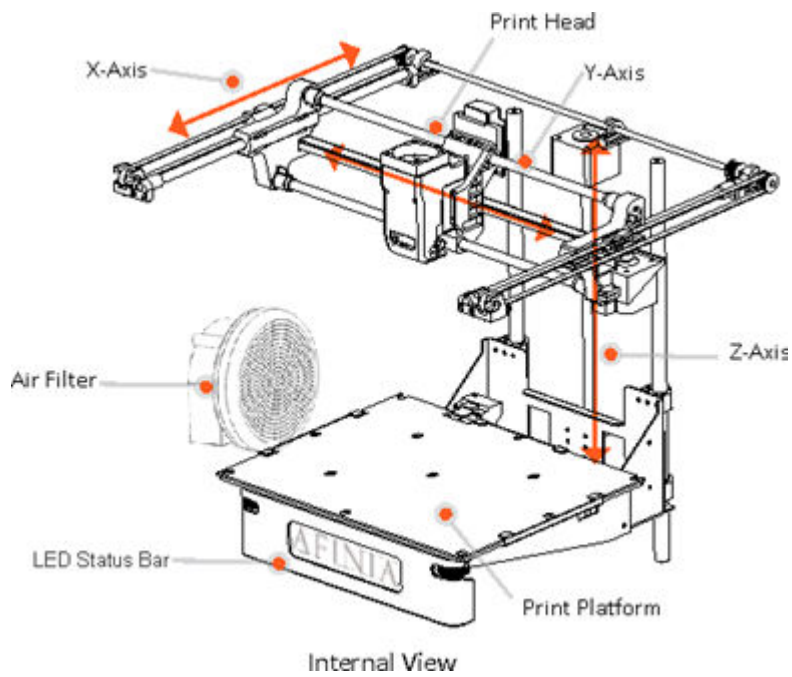
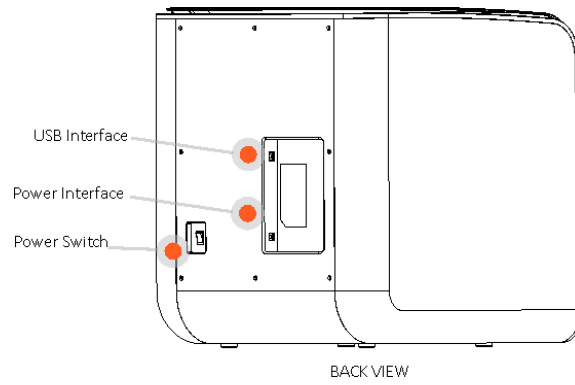
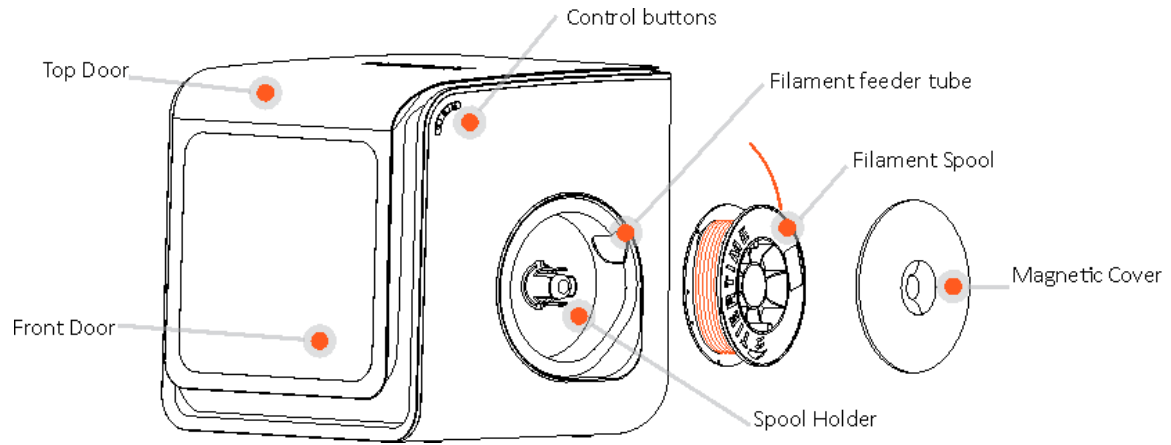

Unpacking the Afinia H800 3D Printer

The Afinia H800 3D Printer weighs over 40 pounds and should be team-lifted!

Remove the power cord and 4 perf boards from the top foam piece.

Remove top foam from the box. Lift the foam ring from around the printer.

With two people, carefully lift the Printer from the box.

Lift the foam sheet below the printer and remove the Accessory Pack, Power Supply, Putty Knife, and Snipping Pliers.

Lift the top cover and carefully lift out the foam above the platform.

Open the front door and carefully remove the two pieces of foam from under the platform. Tip each foam piece back until it is lying flat, then turn the foam counter-clockwise until the left end of the foam is through the door.



Use the snipping pliers to carefully cut the 6 labeled retaining strap loops from around the Print Head rails near the top of the printer.

Cut only the straps!

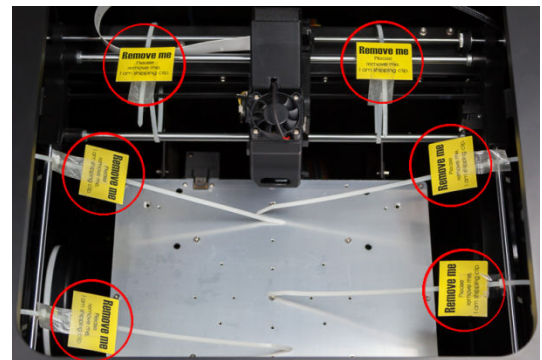

Next, check the Accessories:

- Reel of Filament (1, Natural/White)
- Power Supply
- Power Cable
- USB Cable
- 2 Flex Boards
- 2 Perf Boards
- Extra Nozzle
- Nozzle Wrench
- Hex Wrenches
- Putty Knife
- Snipping Pliers



The Print Head

The Print Head is held in place using three guide magnets in the extruder bracket.

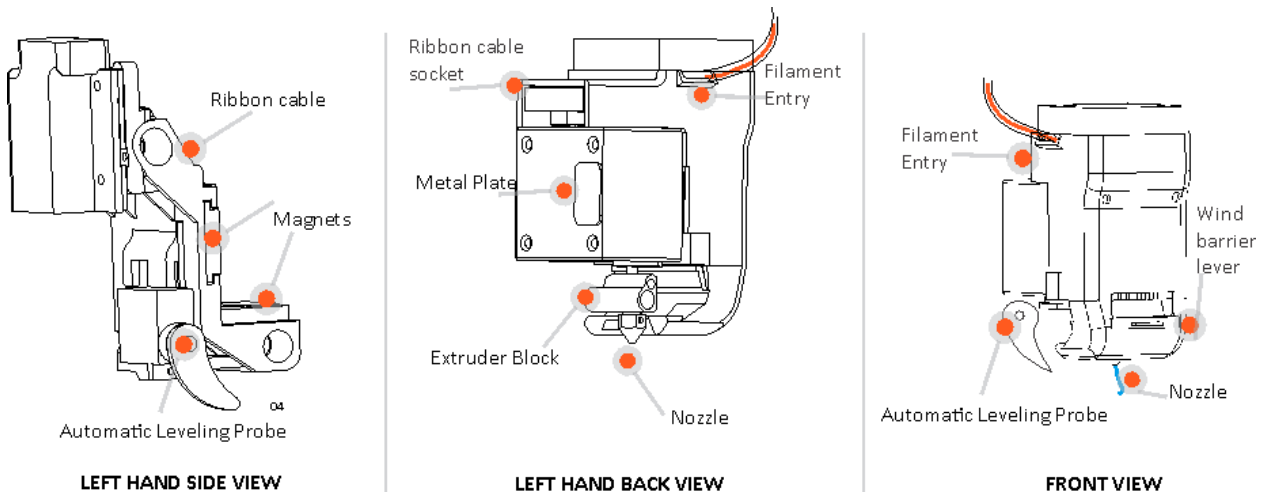

The Print Head is already installed in the Printer. You do not need to do any assembly.

The Control Buttons

You can do a lot with your Afinia H800 by using the Control Buttons, so it follows your every command.

You also use the Afinia software to control the Afinia H800.

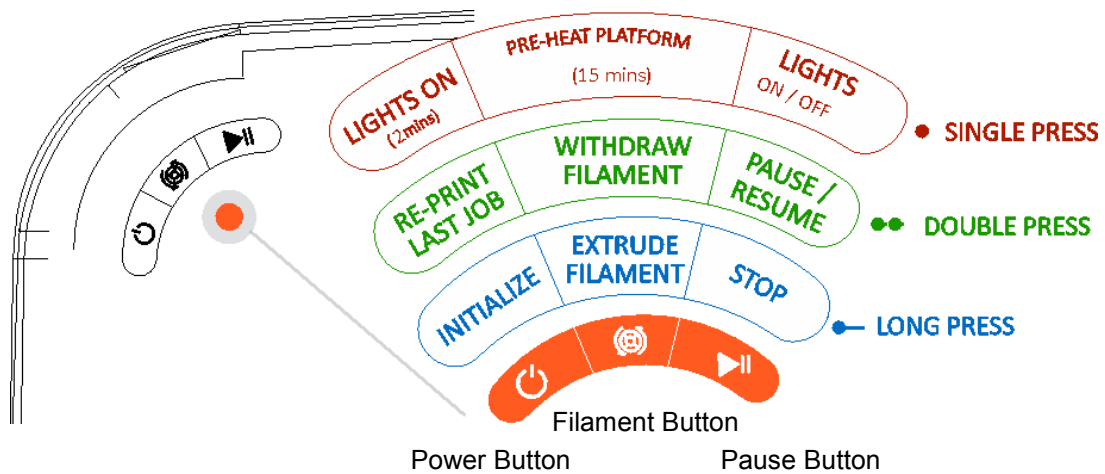

Installing the Afinia H800 3D Printer

You will need the USB Cable, Power Supply and Cable, and Filament Spool to complete the Afinia H800 3D Printer installation.

Driver and Software Installation

Mac

Insert the Installation Disc into your Mac. Open the disc, go into the **Mac** folder, and double-click **Afinia Mac Setup.pkg**. Follow the prompts through the installation. The drivers will be added and the Afinia software will be installed to the **Applications** folder.

Windows

Insert the Installation Disc into your PC. If the installer does not launch automatically, start the Afinia 3D Printer **setup.exe** file in the **PC** directory on the installation disc.

Note: This installs the Afinia 3D Printer software, the Afinia 3D Printer drivers, and the Afinia 3D Printer sample files into your **Program files\Afinia\Afinia 3D Printer** folder.

Follow the instructions in the Installer to be sure the drivers and software are all in place before attempting to use the Printer. The instructions below will follow the same order as those in the Installer.

Installing the Printer

Connect the power adapter as shown with the flat side out and turn on the power switch.



Long Press the Power button on the control panel to initialize the printer.

Connect the printer to your computer using the supplied USB cable.

USB connection



The Printer will be recognized and automatically installed when it is connected to your PC or Mac.

Loading the Filament

- A. Insert the end of filament into one end of the Filament tube, which is on the upper right side of the spool holder.
- B. Feed the filament through the tube until about 4 inches of filament protrudes from the tube.

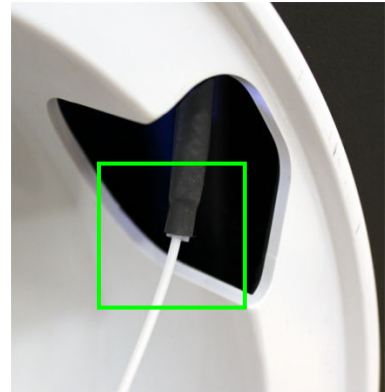

- C. Put the Filament Spool onto the holder with the end of the filament pointing up from the back.

- D. Feed the filament into the extruder head as far as it can go (about 2 inches) using the feed tube just behind the fan.

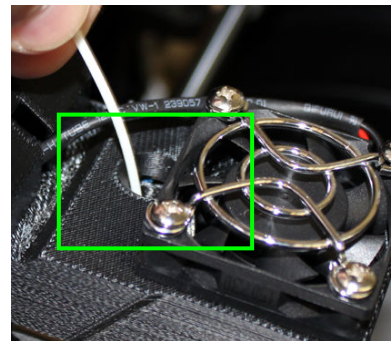

- E. Long Press the Filament button.
 - a. If the filament doesn't start feeding when the printer beeps, gently push in the filament.

- F. Replace the magnetic filament cover.



Getting Ready to Print

Starting the Afinia 3D Program

Open the Afinia 3D software on the desktop (Windows) or in the Applications folder (Mac).

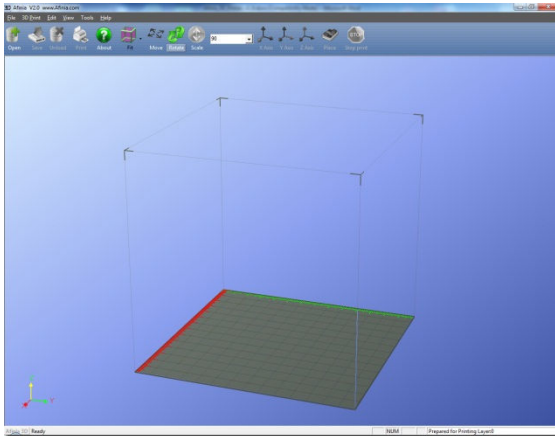

Windows version

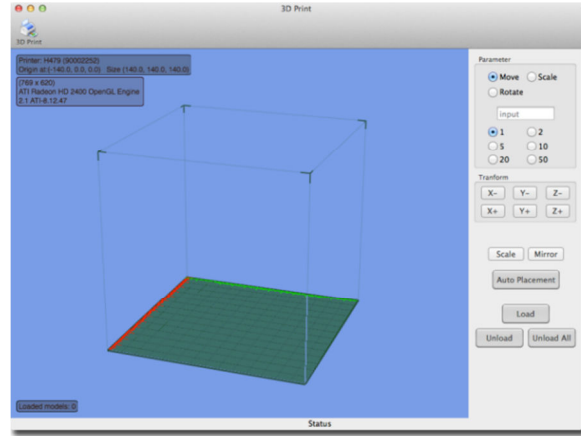

Mac version

Initializing the Printer

Long Press the Power Button or click **Initialize** in the **3D Print** menu. The printer will beep, the platform and print head will move to the printer's home positions, and beep again when it is ready.

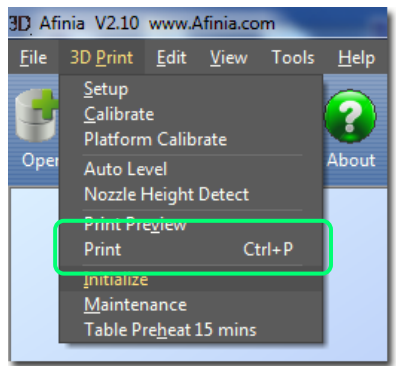

Windows version

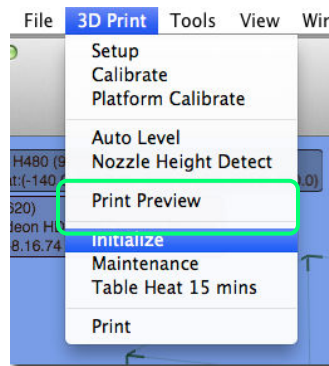

Mac version

TIP: If your printer is not responding properly, always first try to re-initialize the printer.

Preparing the Platform

The print platform needs to be prepared so the model adheres to the platform enough to be printed while still being easy to remove from the platform when done.

Never print directly to the aluminum platform!

There are several options:

Perf Board (Glass-reinforced Epoxy Laminate)

The Perf board is held in place by the 13 mounting screws and two spring-loaded bearings.

Apply slight downward pressure on the two spring bearings when sliding the perf board back into place. The heads of all 13 mounting screws will lock down the board when installed correctly.

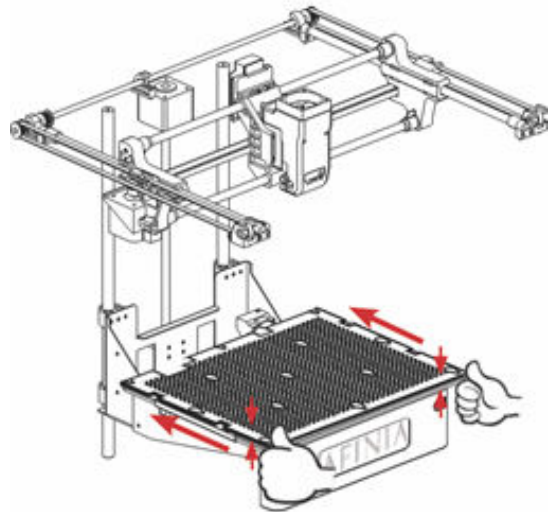
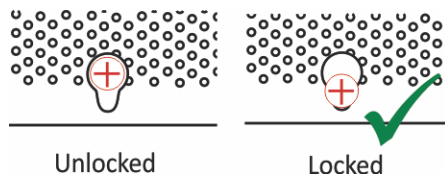

Flex Board (Perf board with pre-installed Flex surface)

The Flex Board is mounted in the same way as the plain Perf board.

Borofloat Glass

Many people use Borofloat glass as the print surface, brushed with an ABS/acetone slurry and allowed to dry into a thin ABS film.

The ABS film will hold the model to the glass, and release from the glass as the glass cools.

If the model does not easily release, spray a small amount of ammonia-based glass cleaner around the model. The same glass cleaner can be used to clean the film from the glass.

It is recommended that you clean and recoat the print surface after each print.

The Borofloat glass can be placed directly on top of the installed perf board or on the platform screws. Use office clips to hold the glass in place.

BuildTak Print Surface

BuildTak is a print surface that self-adheres to the plain Perf board or to glass. If adhering to glass, be sure that no air is trapped between the glass and the BuildTak.

Position the BuildTak surface on the actual print zone – the Perf board is larger than the surface, with the perimeter outside of the print zone.

Borofloat glass and BuildTak are available at store.afia.com.

Whichever platform preparation method you use, having a well-leveled platform, a correctly-set nozzle height, and a pre-heated print surface will improve your results.

The next few pages walk you through these steps.

Leveling the Print Platform

Before calibrating the nozzle height, check the vertical nozzle distance at each corner and center of the print platform. Open **Maintenance** from the **3D Print** menu and click the **Center** button.

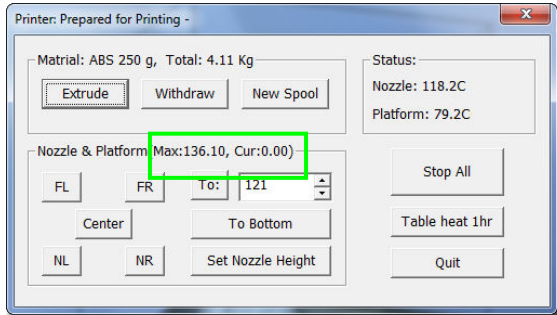

Windows version

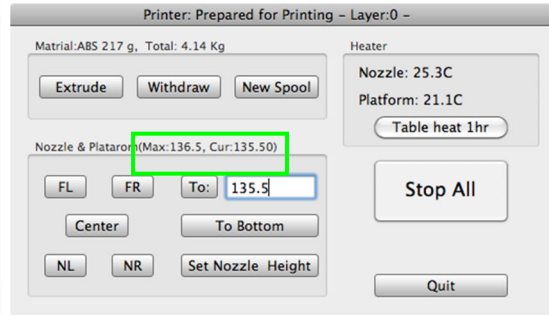

Mac version

If you know the nozzle height, enter that height in the **To:** box, then click the **To:** button.

If you don't know the nozzle height, click the **To:** button to bring the platform to the displayed height, then slowly increase the height until the platform is about 0.2 mm from the nozzle, clicking **To:** after each increase.

Use the five position buttons to check that the platform at all four corners and the center are close to the same distance from the nozzle.

If the platform is not close to the same distance from the nozzle at all five points, adjust the platform until it is as level as possible. Use the 3 Leveling Dials under the platform arm to level the print platform.

Turning a dial clockwise will raise the platform above that dial.



Leveling Dials
(Viewed from under platform)

Always recalibrate the platform and nozzle height after leveling the platform.

The more level your platform is, the better your print will be!

Platform Calibration

Along with manual leveling the platform, the Afinia software can run a Platform Calibration to adjust the printing of the raft, laying down a level foundation for your model to be printed on.

This process is not intended to replace physically leveling the platform, but to work with the leveling.

Note: The Platform Calibration will only affect printing when using a raft. If you are printing without a raft, the Calibration is not used.

You can calibrate the platform automatically or manually.

Automatic Platform Calibration

The automatic process will check the height of nine calibration points on the platform.

Select **Auto Level** from the **3D Print** menu.

The differences in height between the nine calibration points are used to build up the raft to give your model a level foundation on which to print.

After the Calibration is complete, the Nozzle Height will be automatically set.

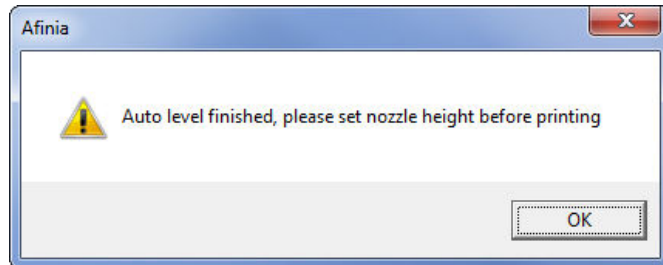

To check the calibration values, open the **Platform Calibrate** option in the **3D Print** menu. Calibration values are in the middle section of that window.

NOTE: If the Platform Calibrate window doesn't open (Mac) or any of the values are left empty (PC), the platform is out-of-level by more than 0.9mm at one or more points. You will need to manually level the platform before running the Platform Calibration again (see page 14).

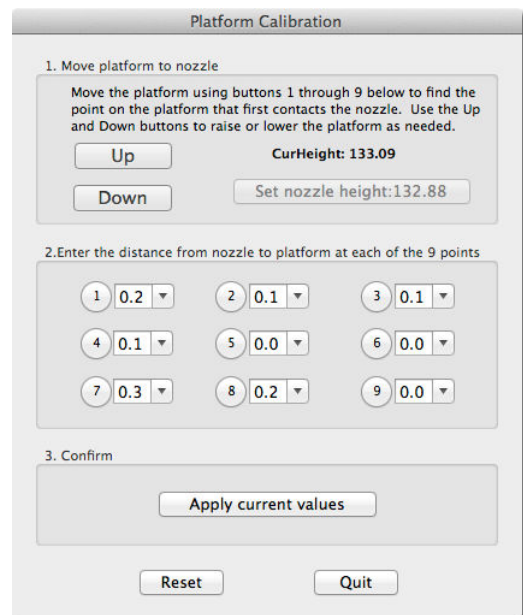

Manual Platform Calibration

Select **Platform Calibrate** from the **3D Print** menu.

Click the button labeled **5** to move the nozzle to the center of the platform. Use the **Up** button to raise the platform.

Hold the button down to move the platform steadily, or use single clicks to fine-tune the platform height.

If you are using clips to secure the print surface to the platform, be careful to position the clips so they do not interfere with the nozzle or wind barrier.

Raise the platform until the print surface is just touching the nozzle and note the current height.

Click the **Down** button a few times to lower the platform and check the other 8 calibration points.

Once you have found the calibration point with the lowest nozzle height, move to that point and adjust the platform position so the nozzle is just touching the print surface.

Click **Set nozzle height**.

Once the nozzle height is set, select the distances from the drop-down lists that brings the platform at the other 8 points into contact with the nozzle.

Once all 9 values have been entered, click **Apply current values**.

Reset will clear all calibration values.

Click **Quit** when you are finished.

Platform Calibration

1. Move platform to nozzle

Move the platform using buttons 1 through 9 below to find the point on the platform that first contacts the nozzle. Use the Up and Down buttons to raise or lower the platform as needed.

Up CurHeight: 133.09

Down Set nozzle height:132.88

2. Enter the distance from nozzle to platform at each of the 9 points

1 0.0	2 0.0	3 0.0
4 0.0	5 0.0	6 0.0
7 0.0	8 0.0	9 0.0

3. Confirm

Apply current values

Reset Quit

Platform Calibration

1. Move platform to nozzle

Move the platform using buttons 1 through 9 below to find the point on the platform that first contacts the nozzle. Use the Up and Down buttons to raise or lower the platform as needed.

Up CurHeight: 133.09

Down Set nozzle height:132.88

2. Enter the distance from nozzle to platform at each of the 9 points

1 0.2	2 0.1	3 0.1
4 0.1	5 0.0	6 0.0
7 0.3	8 0.2	9 0.0

3. Confirm

Apply current values

Reset Quit

In the example above, the print surface is slightly warped with the center higher than both the front and back edges. The manual leveling process would not be able to account for the warp, but the Platform Calibration can.

Calibrating the Nozzle Height

This section is one of the most important of the entire manual. Please read it carefully to help you understand the nozzle height setup procedure.

To print successfully, the platform should be 0.2mm from the nozzle. As each printer is slightly different, this distance needs to be calibrated before starting to print.

You can set the nozzle height either automatically or manually.

If you are using any print surface other than the supplied plain Perf Board, Flex board, or Perf board with BuildTak, you will need to set the Nozzle Height manually!

Automatic Nozzle Height Calibration

The Automatic Nozzle Height Calibration process will only work with the supplied Perf boards, a Perf board with BuildTak adhered to the board or Flex boards as the print surface. If you are using any other surface, manually set the nozzle height.

Select **Nozzle Height Detect** from the **3D Print** menu.

The extruder will move to the back left of the printer and the platform will lift until the nozzle contacts the Nozzle Sensor.

If you are on a PC, select whether you are using the Flex board (or plain perf board with BuildTak) or a plain Perf board. The detected nozzle height will then be displayed.

Click **OK** to close the window and set the nozzle height.

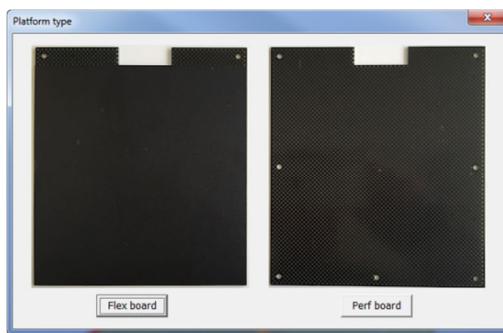

Manual Nozzle Height Calibration

To manually set the correct nozzle height:

1. Open **Maintenance** from the **3D Print** menu. The current nozzle height is shown in the **Maintenance** dialog images below.

In the Windows example, the platform is at the bottom of the printer; the Mac example has the platform 135.5mm from the bottom.

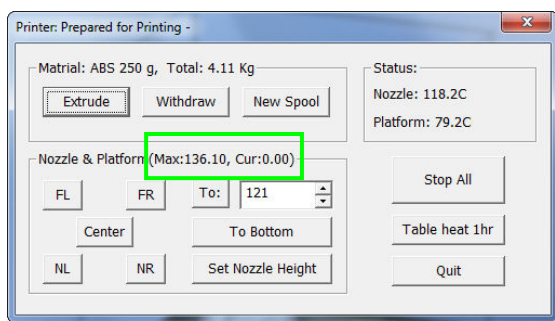

Windows version

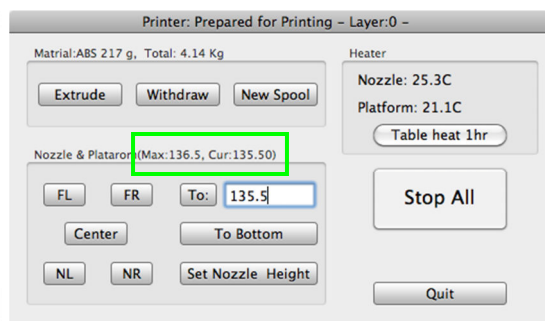

Mac version

2. Click the **Center** button.
3. Raise the platform by entering a value into the **To:** textbox and click the **To** button.
4. Check the distance between the nozzle and the print surface. If the platform is more than 0.2mm from the nozzle, slowly raise the **To** value and click the **To** button each time. Small changes will help avoid striking the print surface into the nozzle.

5. Repeat until the print surface is 0.2mm from the nozzle, about the thickness of a piece of paper folded in half.
6. Check the nozzle height at all four corners of the platform. If any of the corners is closer to the nozzle than the center, use that point to set the height.
7. With the print surface 0.2mm from the nozzle, click the **Set Nozzle Height** button to save the current nozzle height.

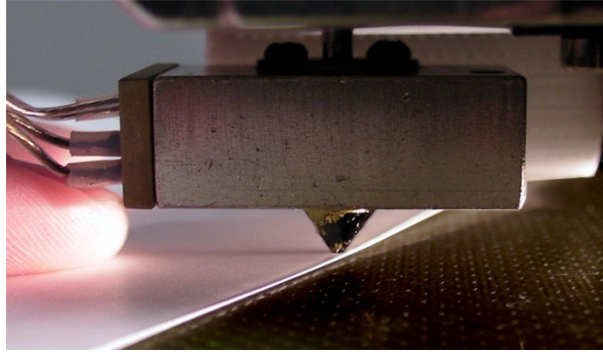

If you haven't manually re-leveled the platform since the last time the Auto Level was run, you can stop here. If you have manually leveled the platform, follow the next 4 steps.

8. Take note of the nozzle height - you may need to reset the height when you run the Auto Level feature again.

TIP: If the print surface contacts the nozzle while making height adjustments, re-initialize the printer and before undertaking any other operations.

Other Maintenance Options

Extrude heats the nozzle and loads material into the nozzle. When the temperature is high enough the material is squeezed out of the nozzle. The printer beeps before material starts extruding and it beeps again when finished.

Withdraw clears the filament from the nozzle when you change the filament or if the nozzle needs to be cleaned. When the nozzle is up to temperature and the printer beeps, gently pull out the material.

New Spool is used by the software to keep track of how much material has been used on the spool, and will warn you if you don't have enough material left to print your model.

Click the button and enter the grams of material on the spool. If it is a new spool, enter the weight of the filament in grams. Also select the filament type to set the nozzle and platform temperatures.

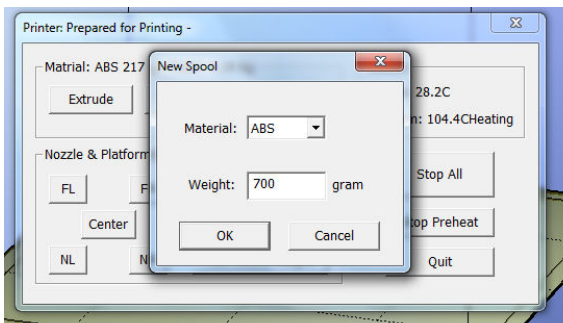

Windows version

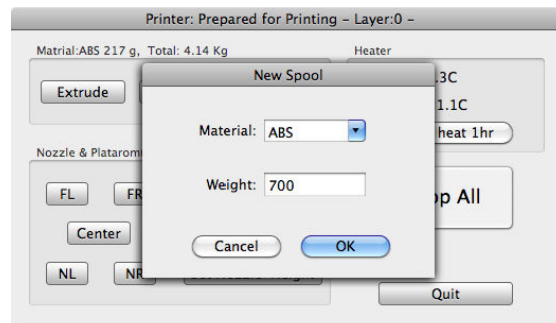

Mac version

TIP: An empty Afinia Premium spool weighs about 280 grams. If you are installing a partially used Afinia Premium filament spool, weigh it, and subtract 280 grams from the weight. Enter that value into the material Weight text box.

Status

This area displays the current temperature of the nozzle and platform and if either element is currently being heated.

Nozzle & Platform Position Controls

The five buttons (**FL**, **FR**, **Center**, **NL**, **NR**) control the position of the nozzle and the platform.

The **To** button controls the height of the platform, and is used in the manual nozzle height calibration procedure described on page 17.

Bottom returns the platform to the lowest position.

Set Nozzle Height

Uses the value in the **To** box and saves it as the Nozzle Height.

Stop All

Stops heating and all the movement of the printer. Once you click this button, the current model being printed is cancelled.

You **CANNOT** resume a print job once the printer has been stopped.

Pause Print

This button will pause a print in mid-progress while allowing you to resume the print job where it left off. This is useful if you want to change the material color mid-print or to allow fasteners to be inserted into printed cavities and then printed over to lock the fastener into place.

This option is only available when the printer is printing and above the first four printed layers.

Table Heat 1 hr

Click the **Table Heat 1 hr** button to heat the table for a full hour to the correct temperature for the selected filament type.

The Status bar will show the progress of the platform heating.  0% 50% 100%

Heating the platform will not take the full hour, but the longer the platform heats, the more the outer edges of the platform will be heated. For prints extending close to the edge of the platform, this will help prevent warping of the model during printing.

Note: You should always preheat the platform prior to printing to ensure the best results.

Stop Preheat (Windows) / Stop Heat (Mac)

This button halts any heating of the table, either the 1 hour heat or the 15 minute preheat from the 3D Print menu or control panel.

This option only appears when the table is being heated.

Printing with the H800 3D Printer

Loading a 3D Model



Click **File / Open** or the **Open** icon on the toolbar (Windows only) and select the model you want to open. The Afinia 3D Printer software only supports **STL** files, **UP3**, and **UPP** formats.

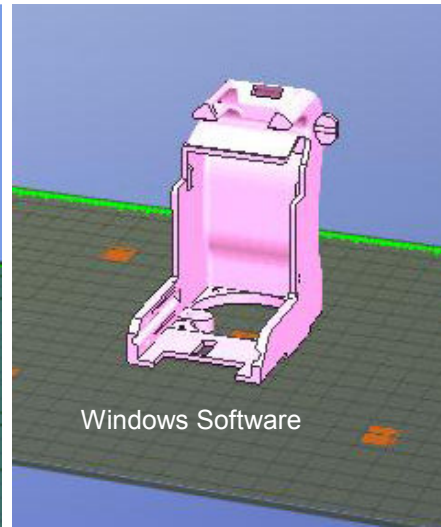
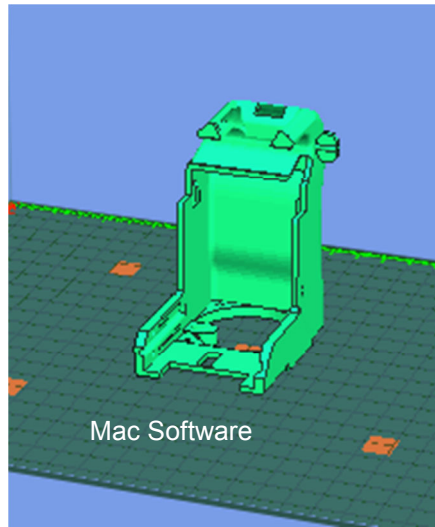

You can open several models and print them all at the same time; see **Placing Models onto the Build Platform** (page 24).

Insert Copy

Add multiple copies of the same model to the platform by selecting **Insert Copy** from the right-click options (Windows) or by selecting **Copy** from the **Tools** menu. Select the number of copies to add from the list.

You will need to reposition the models after the copies have been added.

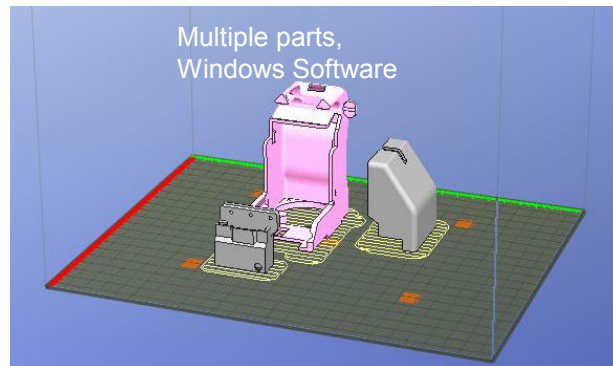

Unloading the Model, Windows

Left-click a model and then click **Unload** on the toolbar to remove the selected model.

You can also right-click anywhere in the software window then choose **Unload** by the selected model name or **Unload All** models if you want to clear everything.

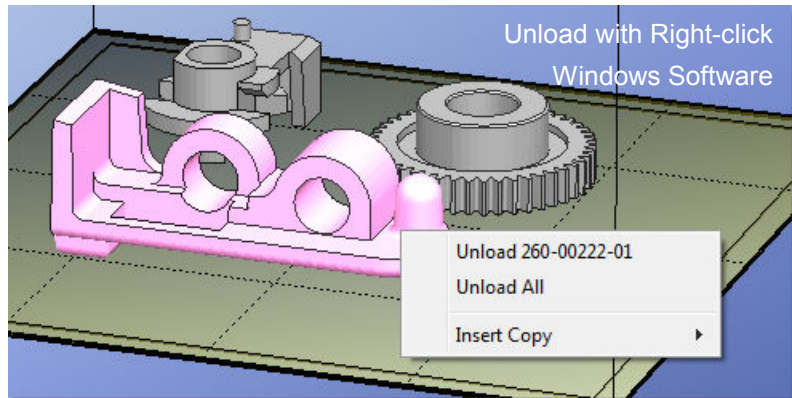

Unloading the Model, Mac

Use either the **Unload** or **Unload All** button in the right tool pane.

Click the **Unload** button to remove the currently selected model, or **Unload All** to clear all models from the workspace.

Note on STL files: For a model to print correctly, all the faces of the models need to have their normals facing outwards. The Afinia H800 3D Printer software uses model color to show problems - if any part of the model is red the normals are facing the wrong direction in that place.

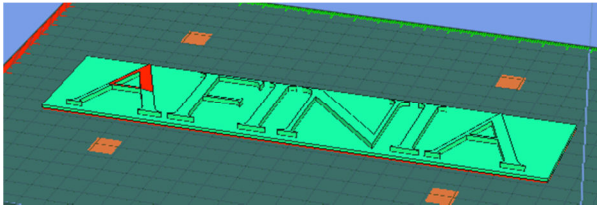

See page 40 for more information on Surface Normals and Model Manifold requirements!

Fixing STL Files

The Afinia 3D Printer software includes a Fix option that will try to fix any bad surfaces in your model. Under the **Edit** menu in Windows you will see **Fix**, and under the **Tools** menu in Mac will be the **Autofix** option. Select the model, and click **Fix** or **Autofix** to attempt a repair of the bad surfaces.

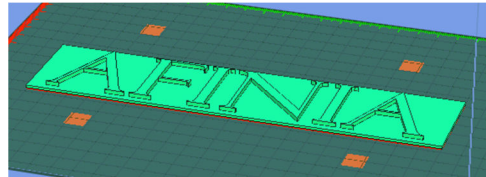

Saving the model

Choose the model and select **Save** from the **File** menu. The file is saved in UP3 format with the file size being 13%-18% of the original STL file size. This is a convenient format for users to archive or transfer files.

Saving the model as a project

Choose the model and select **Save As Project** from the **File** menu. All of the settings within the **Setup** or **Preferences** will be saved, as well as the **Quality** and **No Raft** settings.

The settings that are not saved within a project include the **Nozzle Height**, **UnSolid Model**, **Heat platform after finish**, and **Pause at** settings.

The project file is saved with an extension of UPP. This file can be copied to other locations or computers without needing to include the original STL file or files.

Merging Models

If you have loaded more than one part onto the platform, combine them into a "single" print by using **Merge** from the **Edit** menu in Windows or the **Tools** menu in Mac.

Open all the models you want to merge, arrange them the way you want on the platform, and click the **Merge** option. If you save the file, all the components will be saved as a single UP3 file.

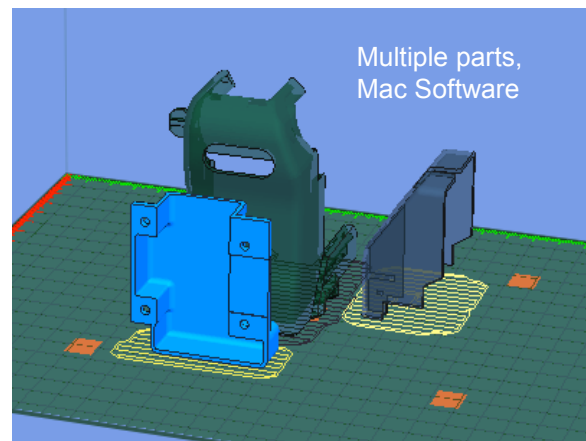

View Options

The mouse can be used to rotate, pan, or zoom the view of the models.

Rotate

Press the middle mouse button and move the mouse to rotate the view.

Pan

Press Ctrl and the middle mouse button at the same time and move the mouse to pan. You can also use the arrow keys to pan the view.

Scale

Rotate the mouse wheel. The view will zoom in or out.

View

The system has eight preset standard views, the default view being **Fit**. Click **View** on the toolbar (Windows) or the **View** menu to select the View options.

The caption under the View button will show the selected view name.

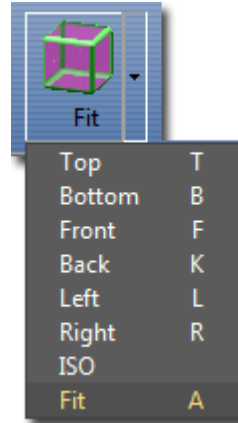

Windows version

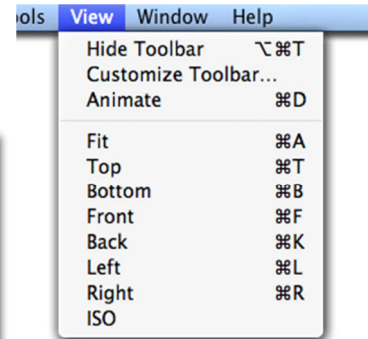

Mac version

Model transformations

Models can be moved, rotated, or scaled using the **Edit** menu or the toolbar:

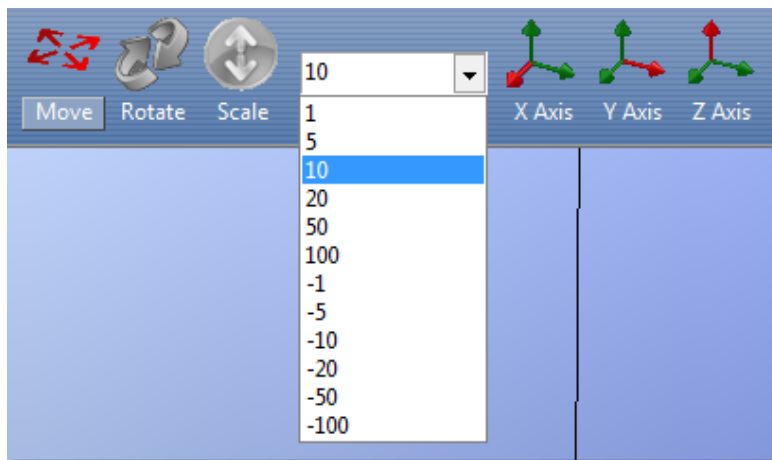
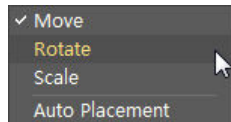

Windows version

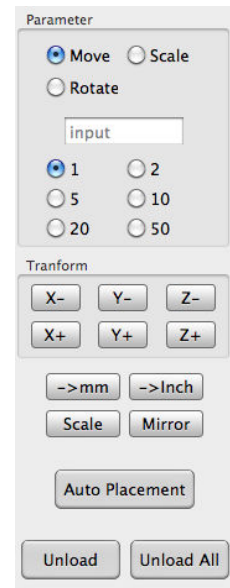



Mac version

Moving the Model

Click the **Move** button and choose or input into the text box the distance you want to move. Then choose the axis (direction) in which you want to move. Each time you click the axis button the model will move again.

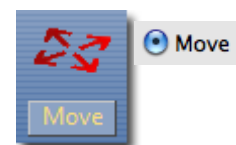
For example: To move the model -5mm along Z axis (or down 5mm):

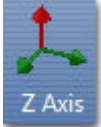

Windows	Mac
<ol style="list-style-type: none"> 1. Click Move 2. Input -5 in the text box 3. Click the Z axis button 	<ol style="list-style-type: none"> 1. Select the Move option 2. Input 5 in the text box 3. Click the Z- button 



Windows TIP: If you hold down the **Ctrl** key, you can drag the model to a position.

Rotating the Model

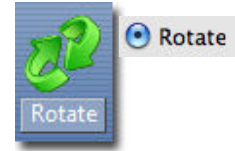
Click the **Rotate** button on the toolbar, choose or input into the text box how many degrees you want to rotate, and then choose the axis of rotation.



For example: To rotate the model around Y axis by 30°.

Windows	Mac
<ol style="list-style-type: none"> 1. Click Rotate 2. Input 30 in the text box 3. Click the Y axis button 	<ol style="list-style-type: none"> 1. Select the Rotate option 2. Input 30 in the text box 3. Click the Y+ button. 

Positive numbers rotate the model counterclockwise; negative numbers rotate the model clockwise.

Scaling the Model

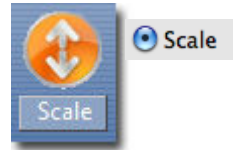

Click the **Scale** button on the toolbar, choose or input in the text box a scaling factor, and then scale the model uniformly by clicking **Scale**. If you only want to scale along one axis, click the axis around which you want the change to be applied.

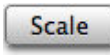

Example 1: Scale up the model uniformly by 2.0 times.

Windows	Mac
<ol style="list-style-type: none"> 1. Click Scale 2. Input 2.0 in the text box 3. Click the Scale button 	<ol style="list-style-type: none"> 1. Select the Scale option 2. Input 2.0 in the text box 3. Click the Scale button 

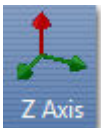
Example 2: Scale up the model by 1.2 times along the Z axis only.

Windows	Mac
<ol style="list-style-type: none"> 1. Click Scale 2. Input 1.2 in the text box 3. Click the Z Axis button 	<ol style="list-style-type: none"> 1. Select the Scale option 2. Input 1.2 in the text box 3. Click the Z+ button 

Example 3: Scaling to convert inches to mm.

Occasionally an stl file may appear much smaller or much larger than designed. This is due to the design software saving the units of measure as inches rather than millimeters; the Afinia 3D software uses millimeters only, so a 1 inch model would appear as 1 millimeter.

This is simple to resolve with these steps:

Windows	Mac
<ol style="list-style-type: none"> 1. Click Scale 2. Select or input 25.4 in the text box 3. Click the Scale button 	<ol style="list-style-type: none"> 1. Select the Scale option 2. Input 25.4 in the text box 3. Click the Scale button

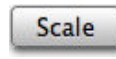
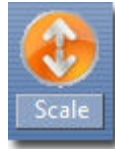

If the model initially appears much too large, convert the size from millimeters to inches by selecting (PC only) or entering **0.03937** into the text box and clicking the **Scale** button.

This does not actually change the model's measurements, just scales it in the software.

Placing Models onto the Build Platform

Where you put your models on the platform can affect print quality.

TIP: In general, try to place your model in the center of the platform.

Auto Place

Click **Auto Place**, on the far right of the toolbar, to center the model on the platform or arrange multiple models.

When there is more than one model on the platform, using Auto Place is recommended.

Windows TIP: Check the **Auto Place** option in the **File** menu to automatically position the model on the platform when the model file is opened.

By Hand (Windows)

Press the **Ctrl** key and choose the target model by pressing and holding the left mouse button. Move the mouse and drag the model to the desired position.

Using the Move button

Click the **Move** button (Windows) or the **Move** parameter (Mac) on the toolbar, choose or input the distance in the text box, and then choose the axis for the direction in which you want to move.

NOTE: When more than one model is open, the gap between each model should be kept to at least 12mm to prevent the models sticking together or rafts from overlapping.

Print Setup Options

Click the **Setup** option in the **3D Print** menu or the **Preferences** button on the **Print** and **Print Preview** windows.

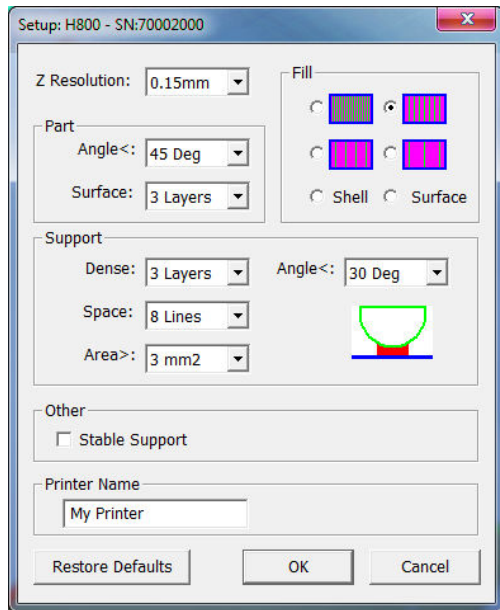

Windows version

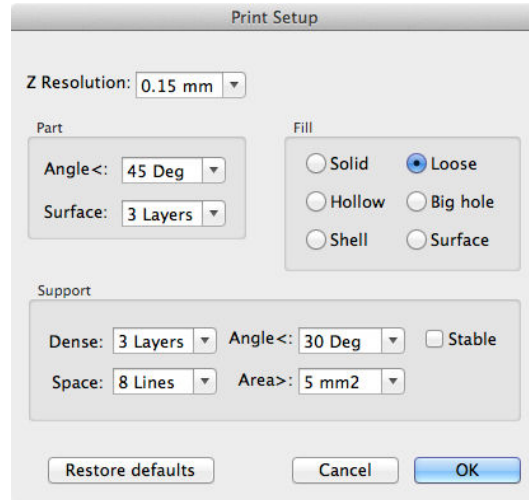

Mac version

Print Settings

Z Resolution

This setting decides the layer thickness of the printer. Options are **0.10mm** to **0.40mm** thick layers.

Part Settings

Angle

The Part Angle sets the horizontal printing orientation for fill printing. At **45 Deg**, the part will be filled in with material printed at 45 degrees to the X- and Y-axes.

The orientation of the part itself will not be changed; just the angle the fill material and solid layers are printed.

Surface





This setting determines how many layers form the bottom face of a part when it is not solid. If you set it to **5**, the printer will print 5 complete layers before printing infill.

You may see more layers printing solidly if you are using very thin layer thicknesses. This is normal.

This does not affect the side wall thickness, which will be approximately 1.5mm regardless of the fill mode.

Fill Settings

There are four ways to fill the interior of the parts, as described below.

<p>The part is 50% filled. This Fill setting is recommended for functional engineering parts.</p> <p>Mac setting: Solid</p> 	<p>The part is 25% filled. This is the default Fill setting.</p>  <p>Mac setting: Loose</p>
<p>Mac setting: Hollow</p>  <p>The part is 17% filled.</p>	 <p>Mac setting: Big Hole</p> <p>The part is 12% filled, using the least amount of material.</p>



Shell

For no fill, select **Shell**.

Checking the **Shell** setting will reduce the material use and print time by not printing the fill material.

Some models may not be suited to printing with the Shell setting checked.

This will not affect the printed model's wall thickness or support material requirements.

Surface

The **Surface** setting will print a model as a single-layer outline of the model perimeter. Note that this setting will not work with models having a base, solid top, or requiring any inner fill structure.

Support Settings

Dense

This sets how many layers of dense support material are printed directly beneath the model. More layers of dense support makes for a more stable print but takes longer to print.

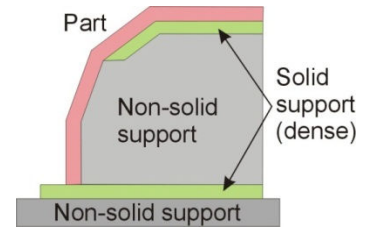

Angle

The Support Angle setting specifies the maximum Angle at which support material will be printed. If the angle from horizontal is smaller than the selected setting, the printer will add solid support layers under the part surface.

If the setting is **10 Deg**, only surfaces that are less than 10 degrees from horizontal will be given support. Changing the value to **50 Deg** will print support material to hold up surfaces that are less than 50 degrees from horizontal.

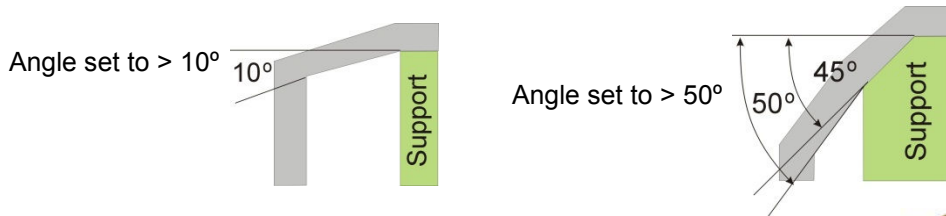

Increasing this value adds more material and time to the print. Decreasing this value may result in poor printing of overhanging surfaces.

There is a balance between minimizing the amount of support material and maintaining the quality of the part, as well as minimizing the difficulty of removing support material.

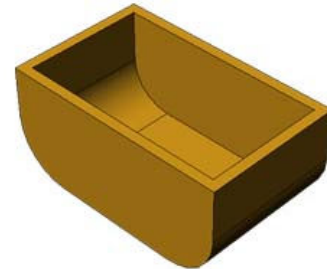

The orientation of the part on the print platform also determines how much support material is printed and how difficult the support material will be to remove.

As a general rule, it is easier to remove support material from the outside of a part than from the inside. In the picture to the right, the part would use a lot more support material if printed with the opening facing down than if it were facing up.

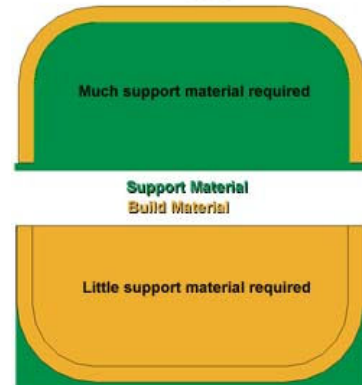

Space

Space sets the distance between the lines of support material. Changing this value will change how the support material is printed; removal of support material and print quality can be affected.

Only advanced users should change the Space setting.

Area

This setting specifies the surface area above which support material is printed. Choose **5 mm²** and there will be no support if the overhanging area is less than 5mm².

Lower values in this setting can save time and filament, but the stability of the part during printing can be reduced.

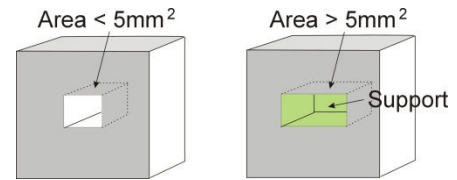

Two special options for the Support Area setting are also available. The **Only Base** setting will use a minimum of support material. In many cases, no support material other than that needed to support the base of the model will be used. The **0 mm²** setting will create support material when the Angle setting is met no matter how small the surface area.

Printer Name (PC Only)

Enter in a name for your printer. This makes it easier to identify when you have more than one Afinia 3D Printer connected to your PC.

Other Settings**Stable Support**

Stable support creates support that is more solid so the model is less likely to distort. This can be useful where tall, narrow support is needed

TIP: Setup and configuration settings except for the Nozzle Height Calibration and Platform Leveling are stored in the software, not on the Afinia H800 3D Printer. If you move the printer to another computer, repeat the calibration and setup procedures.

Printing

TIP: Two keys to successful printing on the Afinia H800 3D Printer are **platform preparation** and **preheating**.

The best results will be achieved if:

- The platform has been leveled and calibrated
- The nozzle height is correctly set
- The printer is in a room that is warmer than 65° F and free of drafts
- The platform is very well preheated

Click **Table Preheat 15 mins** in the **3D Print** menu or Short Press the Filament Button on the panel. Click **Table Heat 1 hr** in the **Maintenance** window to preheat the platform for one hour.

When printing with ABS, let the platform heat to at least 90° C before sending the print. **Maintenance** in the **3D Print** menu displays the platform and nozzle temperatures.

Click **Print** in the **3D Print** menu.

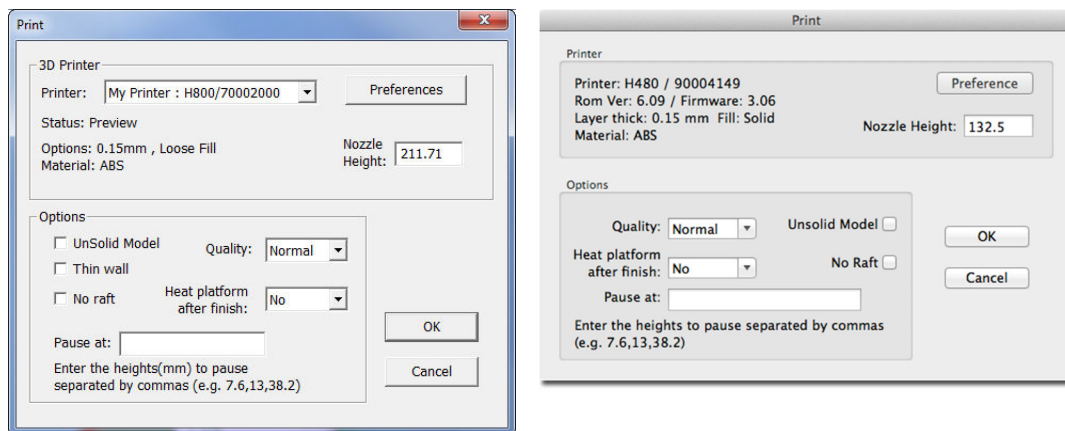

The software sends instructions for printing each layer of the model to the printer. When that is complete, the material usage and estimated print time is displayed.

The USB connection to the printer can be unplugged at this point.

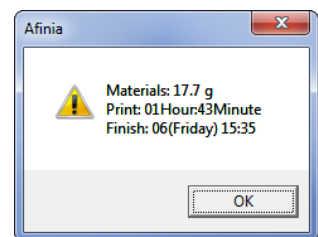

Print Options

Nozzle Height

You can make changes to the Nozzle Height using this setting for the current print only, but it is not recommended unless you know that the value you are entering is correct.

It is recommended that you use the **Calibrate Nozzle Height** process as listed on page 17 to make any changes rather than in the Print dialog.

Quality

Options are **Normal**, **Fast**, **Fine**, and **Turbo**, which affects the speed at which the printer moves. Generally, the slower you print the better the quality of the parts.

For tall narrow parts, running at **Fast** or **Turbo** speed can put down layers too fast; if the last layer hasn't yet hardened, the part may distort.

For large surface area parts, the **Fine** setting will take longer to print and the corners of the raft may lift from the platform.

UnSolid Model

Not all STL files are going to be perfect. A perfect STL file is a fully enclosed surface, with no gaps in the surface skin, and no overlapping surfaces. If your file is not perfect, this option should allow you to print it anyway.

The software will auto-detect models that may require this setting and check this option. You can remove the check to de-select this function if needed.

Thin Wall (PC Only)

If your model has places where the thickness of the part is less than about 0.75mm, this option will force the printer to include the wall when printing rather than potentially leaving it out.

This option is only available in the PC software at this time.

No Raft

You can print without a Raft, but it is not recommended. The raft improves adhesion to the platform.

Also, the **Platform Calibrate** feature (see pages 15-16) is bypassed if the raft is not printed.

Heat Platform after finish

Checking this option keeps the platform temperature hot after printing is complete, which may make it easier to remove the model from the platform. It also keeps the platform heated so you can start your next print more quickly.

Pause At

Enter heights in millimeters to pause the printer at those heights during printing.

Multiple heights can be entered into the setting, separated by commas. Entering **13.5, 20, 27.25** will automatically pause the printing when it has reached 13.5 millimeters, 20 millimeters, and 27.25 millimeters.

This can be useful for changing filament or adding a non-printed part at a specific point during the printing of the model.

You do not need to add the height of the raft to the numbers you enter; the software will do this for you.

Use the printer buttons or the Maintenance window during the pause to perform the **Withdraw**, **Extrude**, and **Resume Print** functions.

Calculating model costs



Calculate the cost of the material that will be used for your model using the **Print Preview** option under the **3D Print** menu. The application will calculate the total weight of material used, including the raft and any support material.

Use that weight to determine the cost to print the model using the following formula:

$$\text{Cost to Print} = \text{Weight of Model} \times \left(\frac{\text{Cost of Spool}}{\text{Full Filament Weight}} \right)$$

Use the weight of the filament that you purchased, not the current weight of the spool. If you are using a 500g spool of Afinia Premium Plus ABS filament, divide the cost of the spool by 500g to get the cost per gram of material.

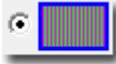
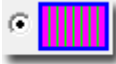
The **Fill** and **Support** settings affect the amount of filament used more than anything else. Say you are printing a cube measuring 30mm x 30mm x 30mm with a layer thickness of 0.15mm. The amounts of material will be used for each of the four **Fill** settings would be:

PC Fill Setting	Mac Fill Setting	Fill Percentage	Weight of Model
	<input checked="" type="radio"/> Solid	50%	17.7 g
	<input checked="" type="radio"/> Loose	25%	12.0 g
	<input checked="" type="radio"/> Hollow	17%	9.1 g
	<input checked="" type="radio"/> Big hole	12%	8.2 g

Note: Shell and Surface fill settings results are not shown.

The cube printed at the lowest density will be about half the cost of printing it at the highest, but this may not apply to all models; each model will have a different ratio of surface to infill. Run a Print Preview to calculate the printing costs of any given model.

TIP: Once the print has started, you can disconnect the USB cable to printer. The print job is stored in the printer's internal memory, so the computer is no longer required. Most actions can be done using the button panel on the computer – pause printing, for instance - but you will need to reconnect the printer to see the exact layer being printed or the nozzle and platform temperatures.

Save as Project

Once your model is on the platform and the print settings the way you want them, you can **Save as Project** option under the **3D Print** menu to create a 3D print project. All of the settings within the **Setup** or **Preferences** will be saved, as well as the **Quality** and **No Raft** settings.

Settings that are not saved in a project include the **Nozzle Height**, **UnSolid Model**, **Heat platform after finish**, and **Pause at** settings.

The project file will be saved with an extension of UPP. This file can be copied to other locations or computers without needing to include the original STL file or files.

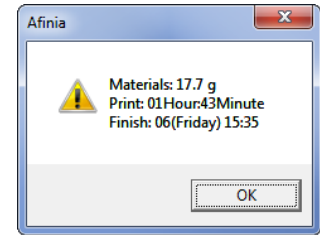

Model Removal

You should never attempt to remove the finished model from the print surface while it is still in the printer. Doing so may affect the platform leveling or bend the entire platform assembly so that it is no longer perpendicular to the printer head.

Use gloves when removing the print surface and model from the printer, as the print surface and model may still be hot. The gloves will also protect your hands from any tools being used to release the model from the print surface.

If you are using the Perf board, press the front corners slightly and pull the board forward to release it.

If you are using any method that clips another surface to the printer platform, simply remove the clips holding the surface to the platform and remove the entire print surface.

Removal from Perf Board

Gently slide the supplied putty knife under the model and slowly wiggle it back and forth to lift the support material from the print surface.

Be sure to clean any remaining material **from both sides** of the Perf Board once the printed model and raft have been removed.





Removal from Borofloat Glass

After removing the glass from the printer platform, allow the glass to cool completely. As the glass cools, you may hear cracking sounds – this is the ABS film releasing from the glass.

If the model doesn't release from the surface of the glass, spray a small amount of ammonia-based window cleaner onto the surface of the glass near the edge of the model. After a few moments, the model should release.

You might need to reapply the ABS film to the glass after each print.

TIP: Depending on the platform preparation method you are using, the model may be easier to remove from the printer when it is still hot. If you want to heat the platform before removing your model, use the **Table Heat** option from the **3D Print** menu.

	<p>CAUTION: It is strongly recommended that you do not attempt to remove the model from the platform while the platform is still attached to the printer. Doing so may damage the printer or affect the platform level and nozzle height calibration.</p>
	<p>GLOVES: It is recommended that gloves be worn as the platform may still be hot and to prevent injury from any tool being used to help remove the model from the platform.</p>

Removing Support Material

You will most likely need to remove any supports printed along with your model.

The support material is the same material as the model material, but printed at a lower density, making it easier to remove and identify.

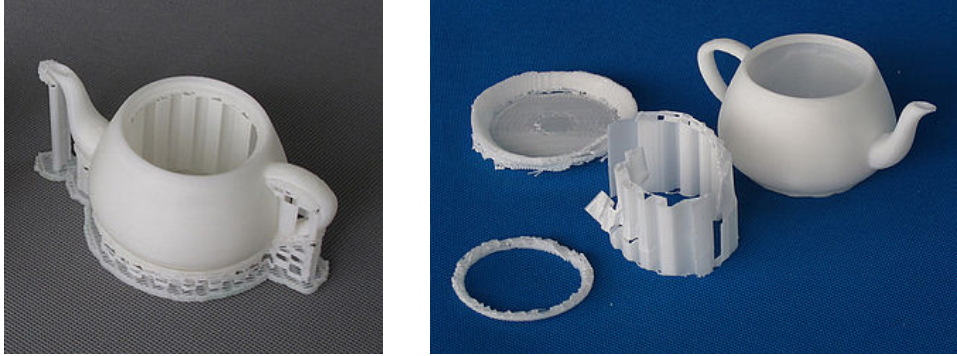

The left picture above shows the teapot with its support material still attached, while the right picture shows the teapot with support material removed.

The support material can be removed using a number of tools, and some can easily be removed by hand. Wood carving chisels, long nose pliers, or wire cutters work well to remove support material.

	GLOVES/SAFETY GLASSES: The support material and the tools are sharp. Wear gloves and safety glasses when removing the part from the printer.
	ALWAYS WEAR GLOVES AND SAFETY GLASSES WHEN REMOVING THE SUPPORT MATERIAL!

Maintenance



Changing the Filament

Changing the filament can be done either in the software or using the control panel.

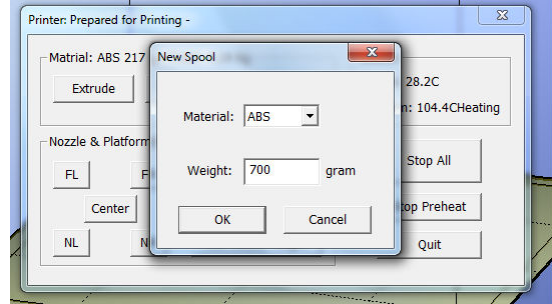
1. Remove the magnetic Spool Cover.
 2. Select **Maintenance** from the **3D Print** menu and click **Withdraw**.
- or-**
- Double Press the **Filament** button.
3. Insert the end of filament into one end of the Filament tube, which is on the upper right side of the spool holder.
 4. Feed the filament through the tube until about 4 inches of filament protrudes from the tube.
 5. Put the Filament Spool onto the holder with the end of the filament pointing up from the back.
 6. Feed the filament into the extruder head as far as it can go, about 2 inches.
 7. Click **Extrude** in the **Maintenance** window
- or-**
- Long Press the **Filament** button.
8. If the filament doesn't start feeding when the printer beeps, gently push in the filament.
 9. Replace the magnetic filament cover.
10. If you are changing filament types, click **New Spool** in the **Maintenance** window, select the filament type and enter the weight of the new spool.
- This must be done in the software, not from the control panel.



TIP: If you are loading a different color filament than the last spool, run **Extrude** a few times before you start printing. This will help remove any left-over filament of the previous color.

	<p>CAUTION: If the nozzle is blocked, remove the nozzle and clean it.</p>
	<p>GLOVES: The extruder and platform are hot. Use gloves when working in this area of printer.</p>

Cleaning the Nozzle

The outside of the nozzle can get covered with a layer of filament during regular use. When the printer is printing, this layer may melt on the nozzle and leave discolored spots in the model or even clog the nozzle. To avoid this, regularly clean the nozzle.

Click **To Bottom** in **Maintenance** and then click **Extrude** to heat the extruder and melt the coating of filament. Wait until the filament is finished extruding, then remove the extruded filament from the nozzle.

Use a heat-resistant material such as 100 percent cotton cloth or soft paper and a pair of pliers. With the material between the pliers and the nozzle, apply gentle pressure and turn the pliers to remove the filament material. **Do not apply heavy pressure!**

Remember, the nozzle can heat up to 260° C (500° F) – that's over two and a half times the boiling point of water. **Do not touch the nozzle or nozzle mount with bare skin!**

If this does not clear up any issues, remove and soak the nozzle in acetone overnight to remove excess ABS material from the nozzle. Ultrasonic cleaning baths also work.

Removing / Changing the Nozzle

If the nozzle becomes blocked, you will need to remove the nozzle in order to unblock or replace it.

Lower the platform to the bottom.

Click the **Withdraw** button on the Printer or Maintenance dialog box to remove the filament from the nozzle.

Once the Withdraw has completed and before the heater has a chance to cool below 200° C, use the nozzle wrench provided in the toolkit to remove the nozzle.

Use the same process to replace the nozzle, being sure to heat the extruder to at least 200° C before tightening the nozzle back down.

Do not apply too much torque to the nozzle to avoid twisting the heater assembly!

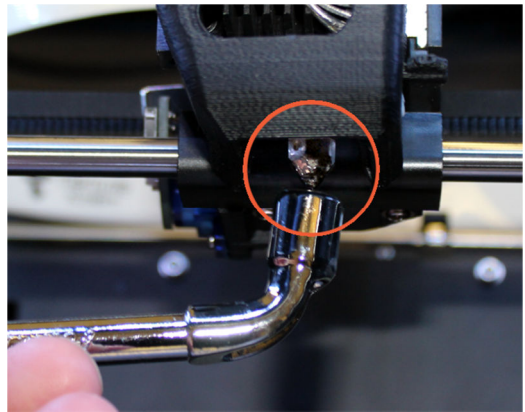

TIP: Heating the nozzle to 200° C will make it easier to remove and replace.



WARNING: Be careful when handling the heated nozzle and nozzle wrench!

Cleaning the Extruder Gear

The gear in the extruder may occasionally need cleaning to keep the filament feeding smoothly.

1. Long Press the **Initialize** button on the Control Panel to put the printer in sleep mode.
2. Turn off the power switch on the back of the printer.
3. Lift the Cable Cover from the top of the Print Head.



4. Disconnect the Ribbon Cable from the Print Head.

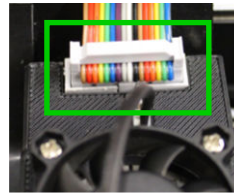

5. Remove the Print Head from the Print Head mount by pulling to the left.

6. Disconnect the fan.

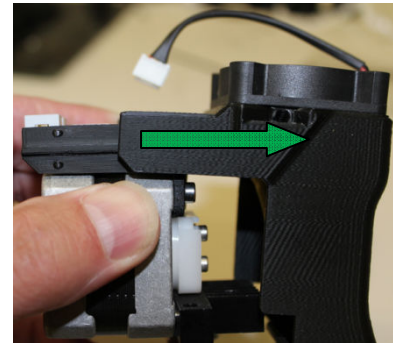

7. Slide the Print Head Cover off the Extruder Motor.

8. Remove the two screws on the Extruder Gear Cover and remove Cover.



9. Clean any filament debris from the teeth of the Extruder Gear.

10. Replace the Extruder Gear Cover and screws.

11. Replace the Print Head Cover. Slide it into place until the Cover clicks.

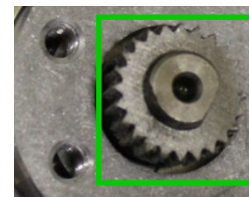

12. Reconnect the fan.

13. Replace the Print Head into the Print Head mount, making sure all three magnets are secure.

14. Reconnect the Ribbon Cable.

15. Replace the Cable Cover.

16. Turn on power and Long Press the **Initialize** button.

Cleaning the Platform

Regardless of your method of preparing the platform, a smooth surface will improve your results.

- If you are using the Perf Board as the print surface, you should remove any remaining filament material from both sides of the board before printing again.
- If you are using blue painter's, kapton, or other type of tape on the platform, replace the tape once it becomes uneven. Remove excess adhesive from the platform before replacing the tape.

Lubrication of Extruder Rails

The extruder rails on the Afinia H800 3D Printer requires lubrication every 4-6 months to keep it operating smoothly. Different lubricants are required for the two rail bearing types.

- The Front-to-Back rails should be lubricated with lithium grease such as Mobil XHP 220.
- For the Left-to-Right rails, use lubricating oil such as Mobil SHC 630.

When lubricating the bearings, clean the rails as much as possible before applying new lubricant. Slide the extruder several times in the all directions to spread the lubricant evenly.

If you have any questions about lubricating the rails, please contact Technical Support (see page 46 for contact information).

Changing the HEPA Filter

We recommend changing the HEPA filter after 300 hours of printing or 6 months, whichever comes first.

1. Rotate the filter cover **counter-clockwise** to remove.
2. Remove the old filter.
3. Install the new filter in the guide brackets.
4. Replace the filter cover and rotate **clockwise** to lock.

The HEPA filter should be replaced by a Class 7 or better filter.



Spare parts

Some of the plastic parts on the printer can be printed by the Afinia H800 3D Printer itself. If you need spare parts for your printer, the files for the printable parts can be found in the **C:\Program Files\Afinia\Example\Spare Parts\H800** folder on PCs and in the **Afinia** directory off the root of the current User directory on Macs.

Vertical Calibration

The Vertical calibration procedure allows you to ensure that the printer platform is perfectly horizontal and that the printer prints consistently in the X, Y, and Z directions.

Open the file **C:\Program Files\Afinia\Example\Calibrate96.UP3** on PCs or in the **Users\{user name}\Afinia\Calibrate96.UP3** directory off the root of the main drive on Macs.

After the calibration model is printed, remove the platform **without removing the parts**.

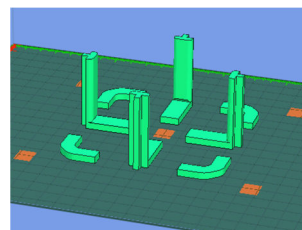

Open **Calibrate** from the **3D Print** menu. Measure the X1 and X2 length, as shown in the pictures below.

IMPORTANT NOTE: Before you enter any new calibration values, the bar at the very top of the screen should read: XY: 0.00 deg / XZ: 0.00 deg. If not, click the **Reset** button!

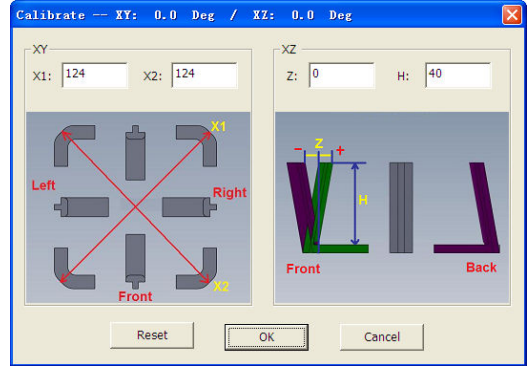

Measure the calibration print from front left to rear right corners of the printed parts on the platform for the **X1** measurement, and the rear left to front right for the **X2** measurement.

Do not include the raft or support material when taking these measurements!

Enter the **X1** and **X2** measurements into the labeled boxes.

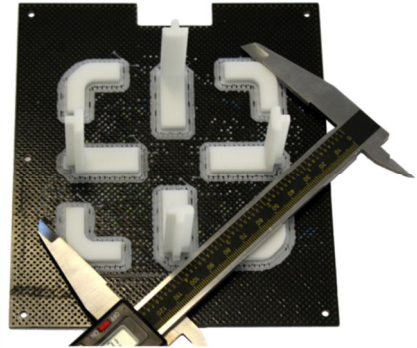

Checking the X1 Measurement

Next, carefully remove the Front Center 'L' shaped component from the platform and check the inside angle. If it is not 90°, measure the exact distance in millimeters that the end of the long arm of the part needs to move to get the angle to be 90°; enter that distance into the Z box.

If the angle is less than 90°, the value to be put into the Z box will be positive. If the angle is more than 90°, the value will be negative. For example, if the end of the long arm is 1.3 mm above the surface, enter **-1.3** in the **Z** box.

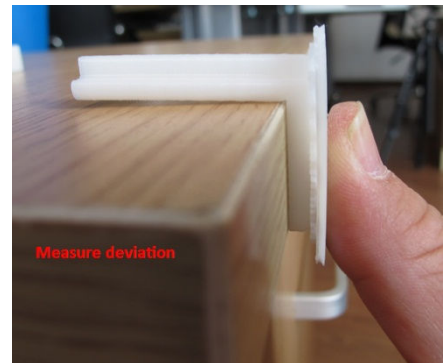

Finally, measure the long arm of the Front Center component from the inside of the angle to the end, which should be 40mm. Enter the exact measured value into the **H** box of the **Calibrate** dialog box.

Click **OK** to record all these values and exit the calibration.

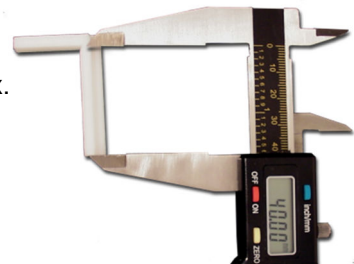

Tips & Tricks

Preheat the platform before printing

Large parts can sometimes have corners lift from the platform, which causes the part to distort.

Preheating the platform (see page 29) to at least 90° C when printing with ABS is a step you don't want to miss. Having the platform heated before print starts helps keep the model adhered to the platform during printing.

Monitor the platform temperature in the **Maintenance** window.

Level Platform and Correct Nozzle Height

Two keys to successful printing and removal of the print raft is to make sure the platform is level and that the nozzle height is set correctly. Use the **Maintenance** window to bring the nozzle close to the print surface, manually level the platform as much as possible, then run the **Platform Calibration** or **Auto Level** utilities to calibrate the platform and set the nozzle height (see pages 15-18).

Be sure to use the calibration utility to build a flat raft surface right below your model!

Position the parts as close to the center of the platform as possible

The center of the platform is where the heating is most regulated, which helps to keep the support raft adhered to the platform. Try to avoid printing any object near the edges of the platform.

Model Orientation Tips

Generally, follow these three simple tips on model orientation for better print results:

- a) Position the model so the largest flat surface is on the bottom
- b) If your model has any cylindrical parts (either solid or holes), position them so they are vertical
- c) Minimize support material by orienting the model with as many concave surfaces up as possible

Remember, these orientation tips may not apply to all models. Each model is unique and has its own best orientation for printing.

Scaling your Model

Not only can the Afinia 3D software scale your model in all three dimensions, you can use the Scale function to change the size in any one of the three dimensions independently. For instance, you can make your model taller by setting the scale factor and clicking just the Z Axis button without affecting the width or depth (see page 23).

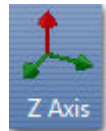

Minimum Model Cross-Section

Due to the width of the extruded filament, models with portions that have a horizontal cross-section of smaller than **0.8mm to 1.0mm** may have missing print areas.

Merging and Rafts

Positioning multiple models too closely in the software can result in overlapping rafts, leading to print failure. Use **Merge** in the **Edit** menu before printing to have the software eliminate that problem by creating a single raft instead of several.

Be sure to save these merged models if you will be regularly printing them as a group!

Minimal Support Material Use

The Afinia 3D Software includes a feature that allows you to avoid most support material. When specifying the Print Preferences, select **Only Base** for the **Support Area** setting (see page 27-28).

Support material around the bottom of the model will still be generated, but the amount of support material will be greatly reduced.

Tighten the Platform Screws

Over time, the screws holding the perf board to the platform may loosen. Tighten them occasionally with the perf board installed, but leave them loose enough to remove the board.

Shell Setting Tips

The **Shell** option for the print **Fill** setting can be used to create truly hollow prints, saving time and filament. However, not all models can be printed with this fill setting.

Models with relatively small horizontal or near-horizontal surfaces are potential candidates for shell printing, as these surfaces require little or no internal support to be successfully printed. Remember, each model is different – you may need to experiment with each model to find out if it can be used with **Shell** printing.

Decrease print time where possible

The faster you can print parts, the less lifting from the platform you are likely to get. Some ways to increase print quality include:

- If possible, try to avoid printing large parts in solid mode
- Set the layer resolution to as large a value as possible while still keeping the quality needed for the finished part
- Print the part in **Normal, Fast, or Turbo** mode
- If printing multiple parts at once, reduce the number of parts that are being printed

Changing Filament while printing

If you need to change the filament during printing, Double Press the **Play** button on the control panel.

When paused, Double Press the **Filament** button to remove the current filament. After changing filaments, insert the new filament and Long Press the **Filament** button to load your new filament.

If you are changing colors, you may need to extrude a few times to remove the last of the previous filament color.

Keep the extruded filament string connected to the nozzle – pull it from the nozzle just before the nozzle contacts the print surface after resuming the print by Double Pressing the **Play** button again; this helps keep stray strands from sticking to your model.

Model Creation: What does “Manifold” mean?

For any model to print correctly, it should be a manifold object. What this means is, as simply as possible, is that each edge must be in contact with two and only two surfaces. Most design software will allow you to create non-manifold objects, which can result in print problems.

The most common way for a model to become non-manifold is when several objects are joined together, creating surfaces in the model that are in contact with or crossing through each other.

Fix in the **Edit** menu of the Afinia 3D software may repair the non-manifold problem areas, but the best solution is to correct problems in your design software. Many software packages can check for and repair non-manifold models – consult the documentation for your software.

Model Creation: What does “Surface Normalization” mean?

The outer layer of every 3D printed object is actually composed of an outer surface and an inner surface. Surface Normalization means these surfaces are pointing the correct way. If you have an outer surface buried inside your model, or have an inner surface on the outside of the model, you will need to normalize the surfaces.

The most common reason for non-normalized surfaces is when two surfaces cross each other.

Fix in the **Edit** menu of the Afinia 3D software may resolve the surface problems, but the best solution is to correct the problem in your design software. Many software packages can check for and remove non-normalized surfaces – consult the documentation for your software.

Status Indicator

The table below explains what each Status Indicator state means.

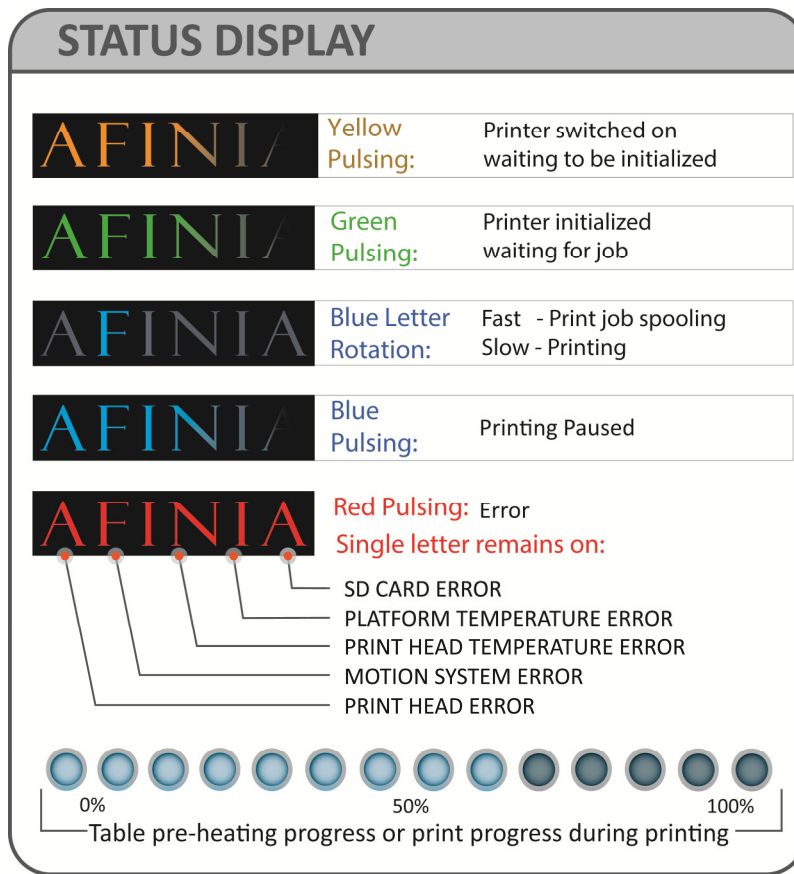

Changing Languages

The Afinia software interface can use multiple languages. To change the language, open the application and enter the correct key sequence from the table below.

The language will change the next time the application is launched.

Key Sequence	Language
CTRL+ALT+N	PC Default Language
CTRL+ALT+E	English
CTRL+ALT+F	French
CTRL+ALT+G	German
CTRL+ALT+S	Spanish
CTRL+ALT+J	Japanese
CTRL+ALT+I	Indonesian
CTRL+ALT+R	Russian
CTRL+ALT+C	Chinese
CTRL+ALT+T	Traditional Chinese

Updating the Printer ROM

Note: *This is a function that should only be performed if necessary.*

1. With the H800 Printer on and initialized, select **Update ROM** from the **Tools** menu.
2. Click **OK** when asked to confirm that you want to update the ROM.
3. Click **OK** to select the ROM update file.
4. Use the browse to find the updated ROM file. This file will be located in the **C:\Program Files\Afinia\System** folder. The file name will include the ROM version just before the **.ROM** file extension.
5. Click **Open** when the correct file is selected.
6. Verify that you have selected the correct file and click **OK**. Click **OK** again to begin the update.
7. When notified that the update is complete, follow the prompts and power cycle the H800.
8. Long Press the **Initialize** button on the control panel.
9. Select **About Afinia** under the **Help** menu (PC) of **Afinia** menu (Mac) and verify that the new ROM version has been applied.

Troubleshooting

Problem or Error message	Solution
No power	Verify power cord is securely plugged in.
	Verify the power switch on the back of the printer is on.
Extruder or platform fails to reach operating temperature	Verify printer has initialized. If not, Long Press the Power button on the control panel to initialize the printer.
	Heater is damaged. Contact Technical Support (page 46)
Material not extruding	Material is stuck in the extruder; remove the material (see page 34)
	The nozzle is clogged and needs to be cleaned or changed (see page 35)
Cannot communicate with printer	Print Drivers are not installed. Run the full installation
	Printer not initialized; use Initialize button on the control panel or Initialize function in software
	Make sure the USB cable is connected to the printer and to the computer
	Unplug the USB cable, then plug in again
	Reset the printer—power off then power on
	Restart the computer
Others	Contact Technical Support (see page 46)

Solution for "Winusb.dll not found" problem (Windows)

If you encounter a "Winusb.dll not found" error message, please follow the steps below:

Option 1: Uninstall Older Driver and Auto-Install New Driver

1. Open the Windows control panel, go to the **System Properties** dialog box and select the **Hardware** tab.

2. Click the **Device Manager** button to open the following dialog box. Find the **3DPrinter@FreeMC** in the USB section.

3. Click the right mouse button and select the **Uninstall** option.

The confirm dialog box will appear. Click **OK**.

4. Install the latest Afinia H800 3D software.

5. Unplug the USB cable then plug it back in. Windows will find a new device. Manually select the driver folder (the default location is **C:\Program Files\Afinia\Afinia 3D Printer\ Drivers**).

6. There should now be a new driver section in the device manager as shown to the right.

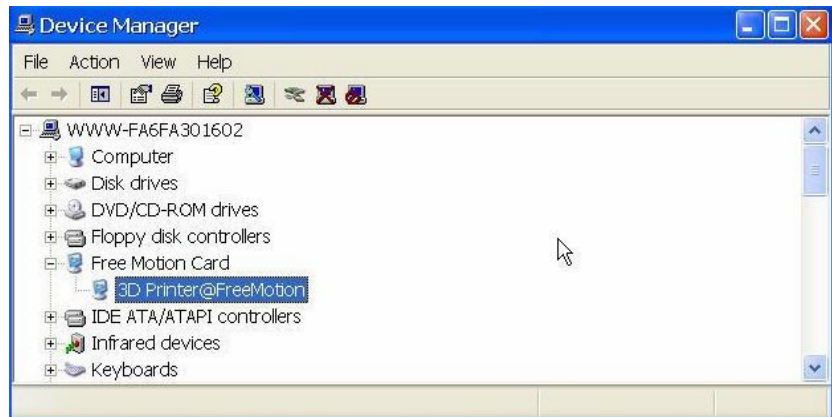
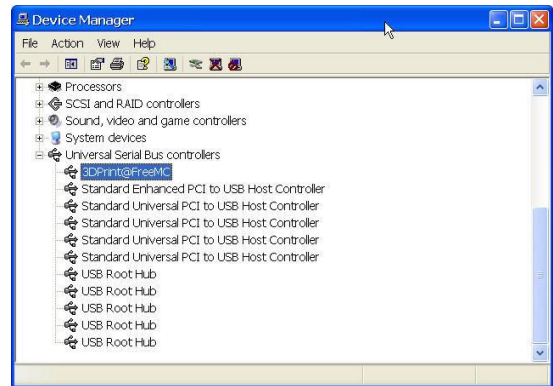
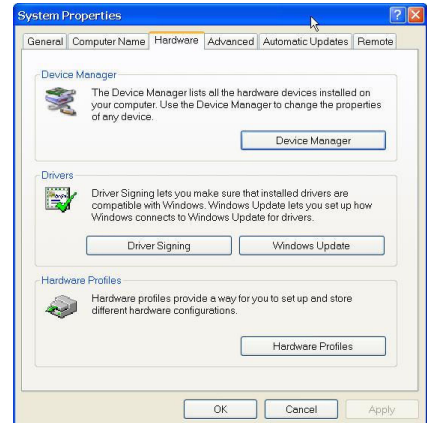

Option 2: Update the driver manually

1. Install the latest Afinia H800 3D Printer software.

2. Find the **3DPrint@FreeMC** driver in the **Device Manager** dialog box (it should be located in the USB section).

3. Right click the entry and select **Update Driver**.

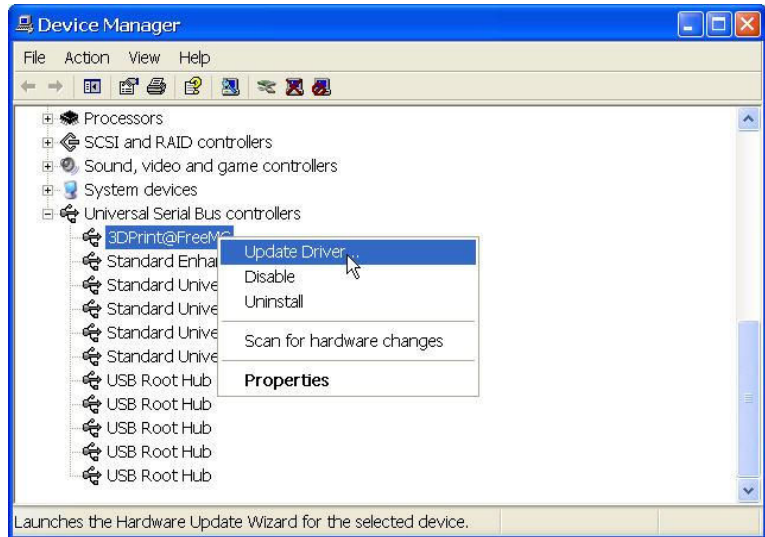

4. Select the Afinia H800 3D Driver folder (the default is **C:\Program Files\Afinia\Afinia 3D Printer\Drivers**).

5. A Free Motion Card entry should appear in the Device Manager list.

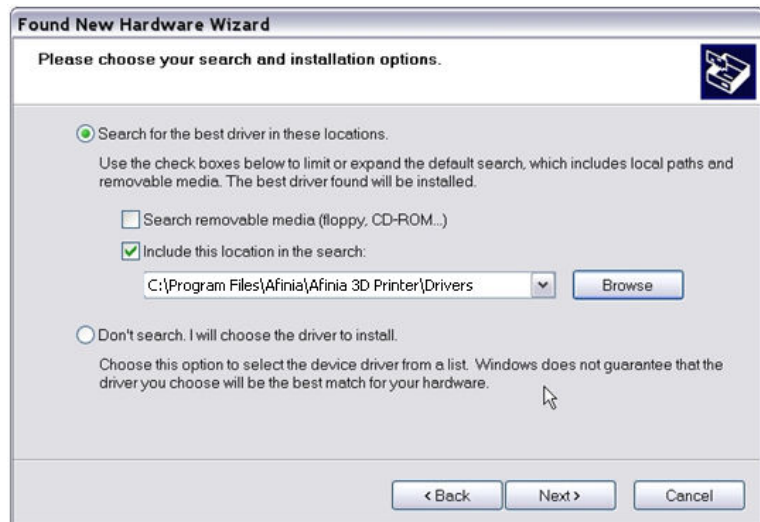

Specifications

Printer Physical Characteristics

Printing Material	ABS or PLA Plastic
Layer Thickness	0.10 – 0.40 mm
Nozzle Diameter	0.40mm
Print Speed	10– 100 cm ³ /h
Print Size	259×207×205mm
Printer Weight	42 lbs. (19 KG) Net 60 lbs. (27 KG) Gross
Printer Size	19.5 × 19.5 × 20.5 in 495 × 495 × 520 mm
Power Requirements	100-240 VAC, 50-60 Hz, 220W

Specifications

Minimum Processor	PC: Intel Core 2 Duo or equivalent Mac: Intel-based only
Operating System Compatibility	PC, 32-bit: Win XP, Vista, 7, 8 PC, 64-bit: Win Vista, 7, 8 Mac, Intel-based: OS 10.6-10.10
Minimum RAM	2GB RAM required
Hard Drive Requirements	500MB available space
Connectivity	USB 2.0
Model Support	Auto-generated Support
Input Format	STL, UP3, UPP

Environmental specifications

Ambient temperature	60°F~85°F
Relative humidity	20%~50%

Technical Support

For technical questions or support issues, contact Afinia Technical Support:

PH: 952-279-2643

support@afinia.com

www.afinia.com

Please have the Model and Serial Number of your Afinia H800 3D Printer available when contacting Technical Support.

Date of Purchase:

Place Purchased:

Serial Number:

(Located on back of Printer)

Acronyms and Jargon

STL	STereoLithography is the common file format used for sharing and printing 3d files
Additive Fabrication	The technical term used for the more user-friendly term of 3D printing.
ABS	Acrylonitrile Butadiene Styrene is a lightweight thermoplastic with resistance to high heat and is the most common plastic used in 3d printing. A strong and generally easy material to print with, but printing large parts can warp.
PLA	PolyLactic Acid is a biodegradable material derived from corn. It warps less than ABS but support removal can be harder. PLA is a great material to use in investment casting or lost wax casting.
Raft	The printer lays down a foundation before it starts printing the model. The raft is used to anchor the model down onto and into the perfboard, as well as correcting any unevenness in the raft.
Perfboard	A reusable and removal build platform that the model is printed onto. (included)
Shell	The external layers of the printed part, much like an egg shell.
Infill	The internal honeycomb structure that gives the part strength
Smart Support	The Afinia software automatically generates supports / scaffold for any overhangs of the model during printing, like building a bridge and having scaffolding to support it.
MEM	Melted Extrusion Melting , the process of melting plastic and 3d printing like a hot glue gun.
Wind Barrier	A small flap at the bottom of the print head that controls the air flow onto or away from the nozzle. Air blowing over the nozzle cools the molten plastic quickly and can improve print quality, but may cause weaker parts and warping
Warping	When a part lifts away from the platform, caused by a poorly calibrated platform or the uneven cooling of the part during printing as the material shrinks back to its normal state. All materials expand when heated and shrink when cooled. The larger the part the worse the effect. ABS is more prone to warping than PLA.
Air Printing	When the printer is moving and acting as if it is printing, but nothing is being extruded out of the nozzle. Check the trouble shooting section for help.