



Model X6 Sauna Room Installation Manual



saunalife.com
800.957.2862

Congratulations on your purchase of the SaunaLife X6 model sauna! If you have any questions during assembly, please feel free to call us at 1-800-957-2862, or email info@saunalife.com. Regular business hours are 8 am – 5 pm, Central, M – F.

Your SaunaLife X6 sauna is specifically designed to utilize your existing floor. As such, assembly is made very simple since the entire sauna sits on pre-fabricated rails and risers. Your sauna can be assembled on any surface that is firm and flat, including concrete, ceramic, vinyl, laminate or tile. Installation on a carpeted surface is not recommended.

SaunaLife X6 Kit Contents:



Floor raiser 1
(qty. 2)



Floor raiser 2
(qty. 2)



Support rail 1
(qty. 4)



Support rail 2
(qty. 4)

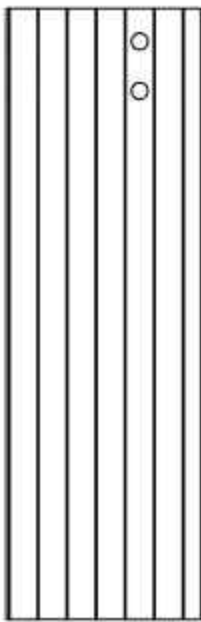

Back wall 1
(qty. 1)

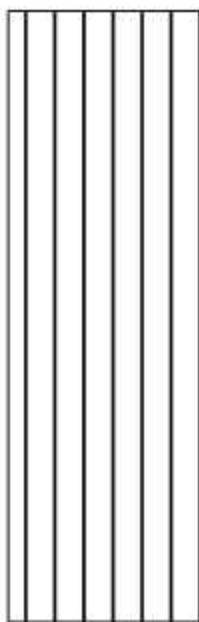

Back wall 2
(qty. 1)

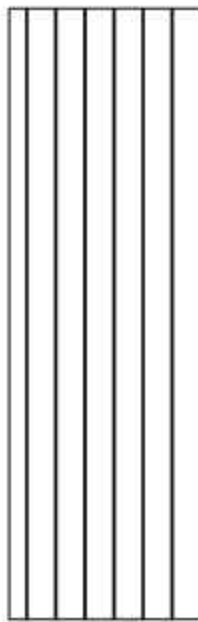

Back wall 3
(qty. 1)



Side wall 1
(qty. 2)

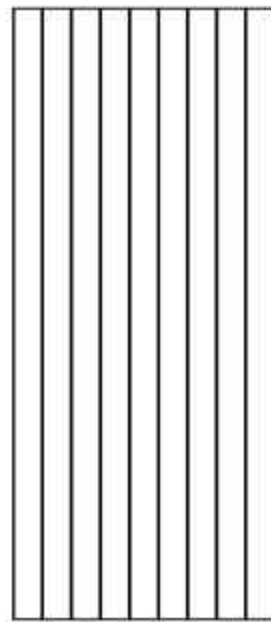

Side wall 2
(qty. 1)

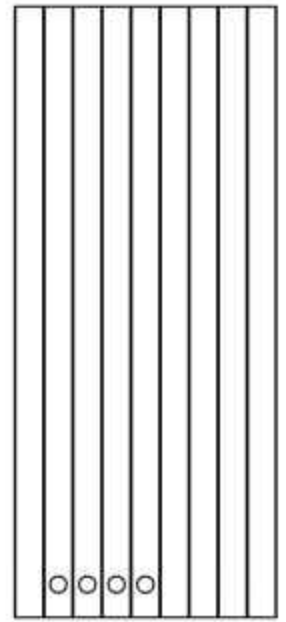

Side wall 3
(qty. 1)

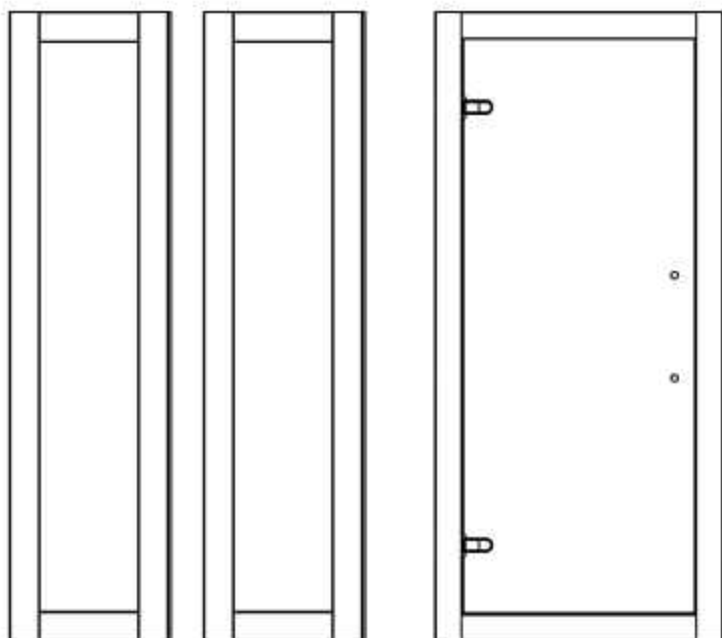

Window element
(qty. 2)

Door element
(qty. 1)

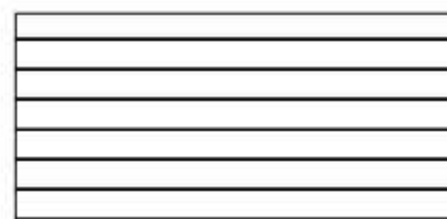

Roof 1 (qty. 1)

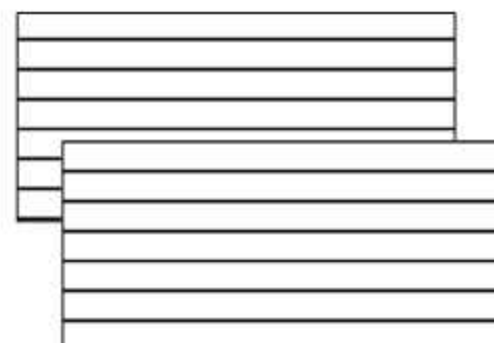

Roof 2 (qty. 2)

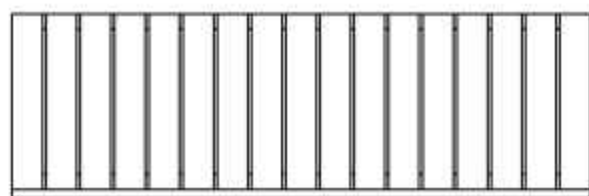

Bench (qty. 1)

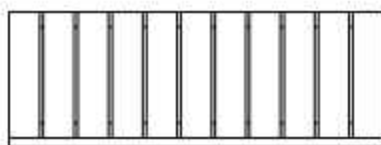

Side bench (qty. 1)



Backrest (qty. 1)



Lower backrest (qty. 1)

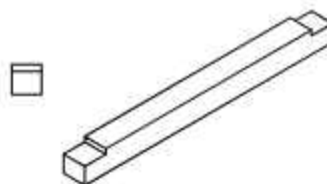

Bench support (qty. 2)

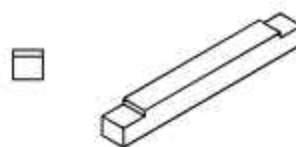

Side bench support 1 (qty. 1)

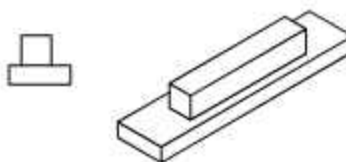

Side bench support 2 (qty. 1)

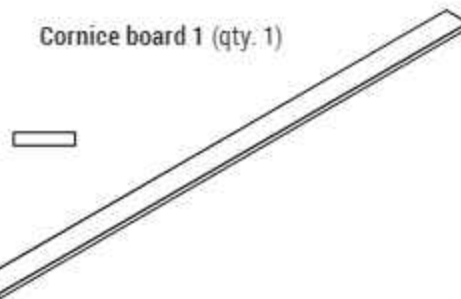

Cornice board 1 (qty. 1)

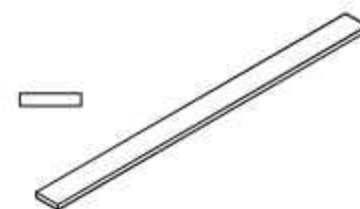

Cornice board 2 (qty. 2)

Read this entire manual thoroughly before proceeding with the assembly.

X6 Sauna Model

Installation & Owner's Manual



Heater fence (qty. 1)

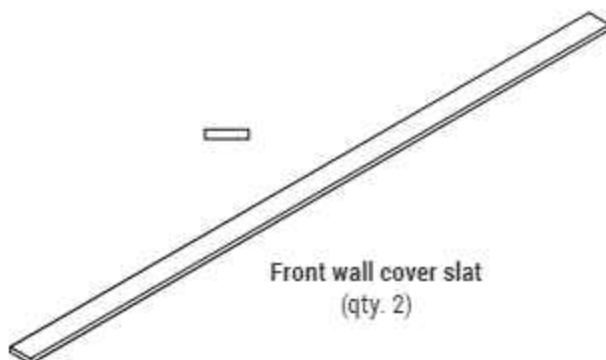

Front wall cover slat
(qty. 2)



Vent cover (qty. 1)

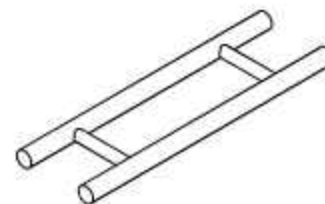

Door handle (qty. 1)



Foot rest (qty. 1)

Tools required for assembly:

- Cordless drill
- Tape measure
- Rubber mallet
- Hammer
- 1/2" or 5/8" Forstner bit
- Utility knife
- Cordless screwdriver
- Screwdriver bits (Phillips & flathead)
- Level
- Step stool or ladder
- Framing square

Screws	Qty.
4.5 x 80 mm (.19" x 3.14")	8
4.5 x 70 mm (.17" x 2.75")	44
4 x 60 mm (.15" x 2.36")	8
4 x 50 mm (.15" x 1.96")	48
3.5 x 40 mm (.13" x 1.57")	26
3 x 20 mm (.11" x .78")	16
Vent Cover Washer	1
Tenon	8

STEP 1.

Connect the Four Floor Risers

Fasten the four Floor Risers together using 4.5 x 80 screws, being sure the two shorter boards are located on the sides and the two longer boards are on the front and back. Use a framing square to ensure the assembly is square.

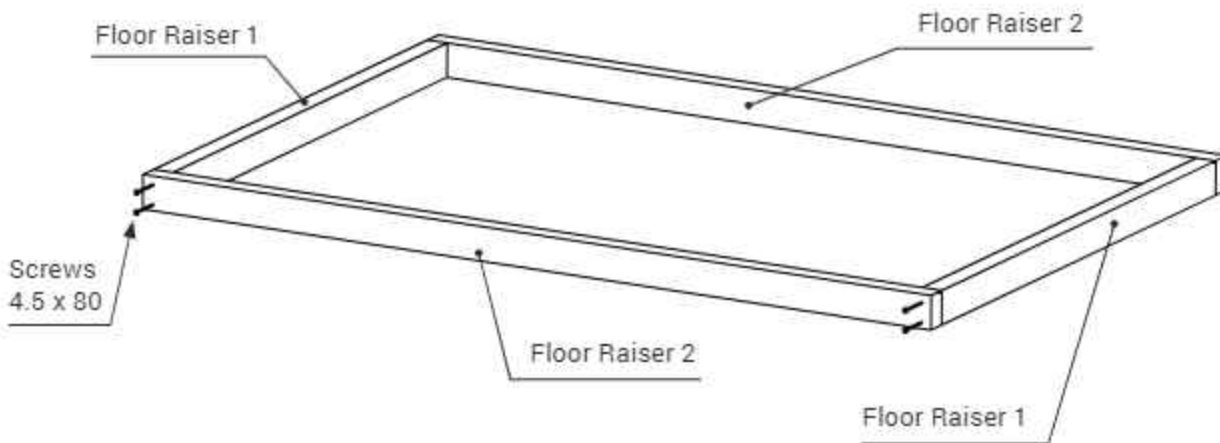

Pre-drill holes for the screws



STEP 2.

Connect Wall Support Rails

Each wall support has a pre-drilled slot for a Tenon. Insert the tenons in the longer support rail holes. Fasten the wall support rails together and connect from corners using four 3.5 x 20 screws per corner.

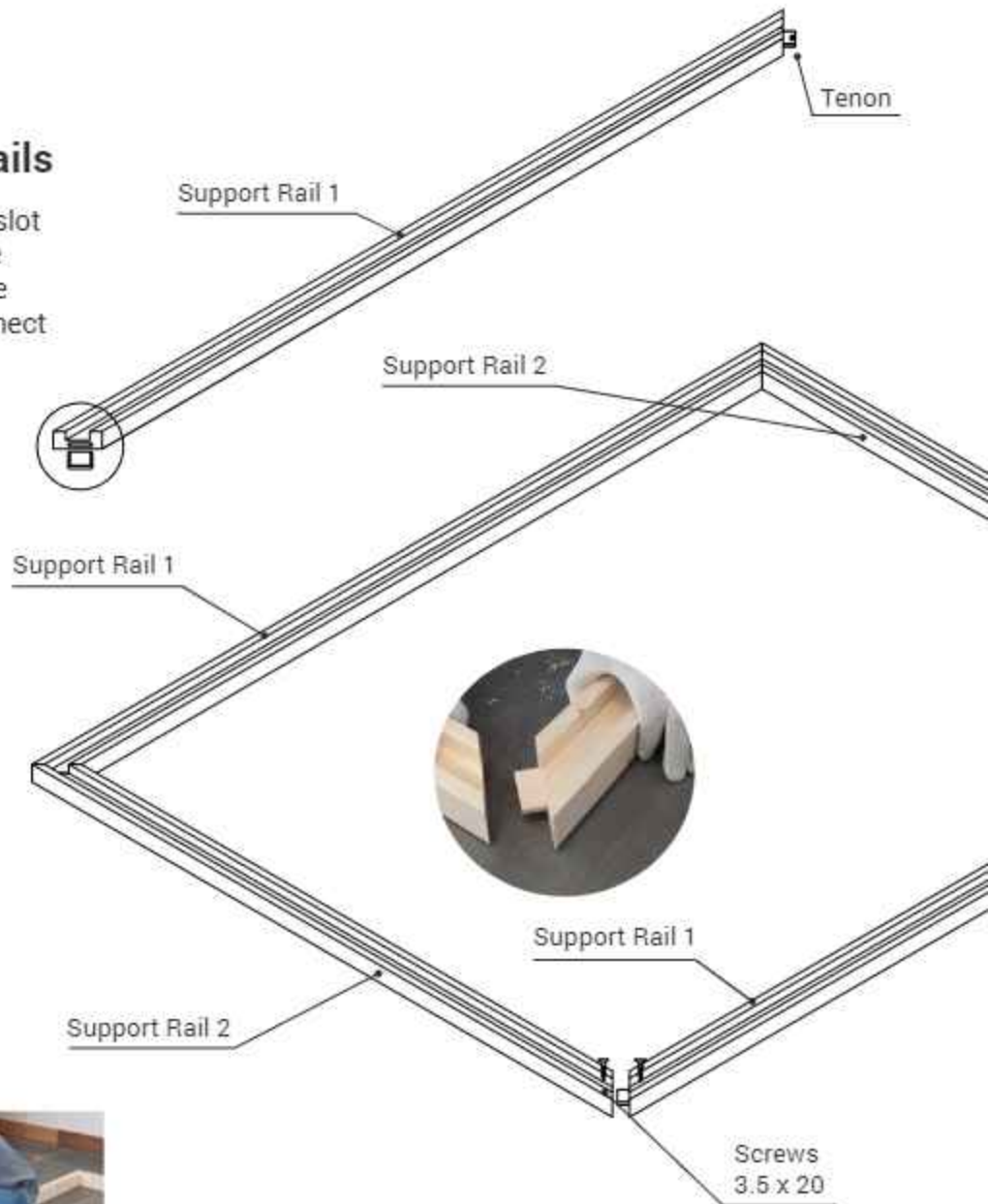
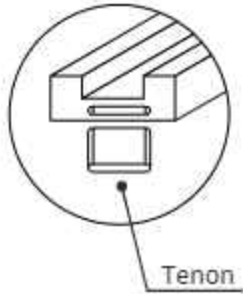

STEP 3.

Position Wall Support Rails

Lay the wall support rail assembly squarely on top of the floor risers with the groove facing up. The rails should overlap both sides of the riser by approximately 0.5".

Secure the assembly to the floor risers using four 4 x 50 screws evenly spaced on each wall support rail.

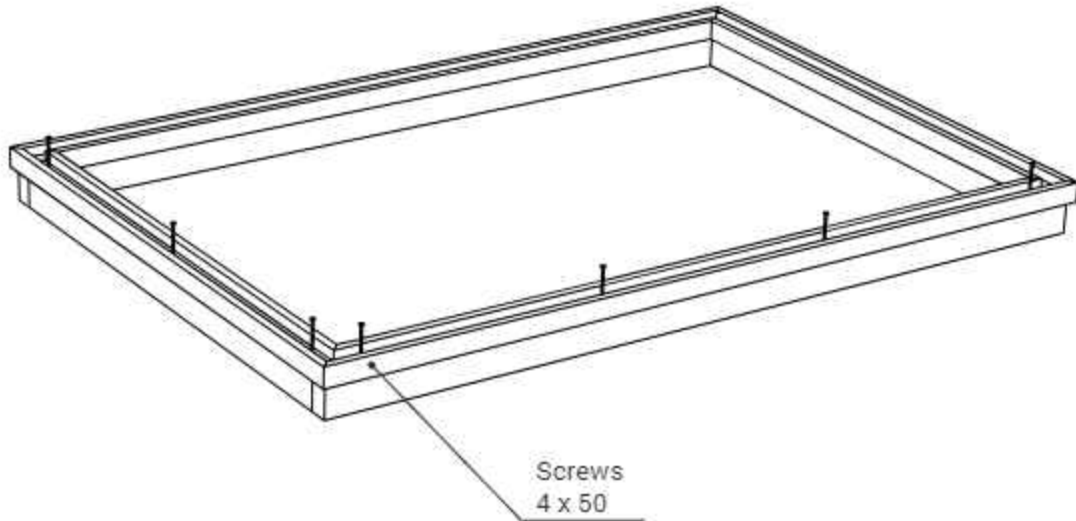

STEP 4.



Position Wall Sections (Back Wall 1 & Side Wall 1)

Position Back Wall Section 1 in the groove of the back rail and push it flush against the left rail. Have a helper hold back wall section. Orient Side Wall Section 1 and place it in the groove of the left rail. Push the flat edge flush against back wall section. Align the two panels so they are flush and fasten them using 4.5 x 70 screws.

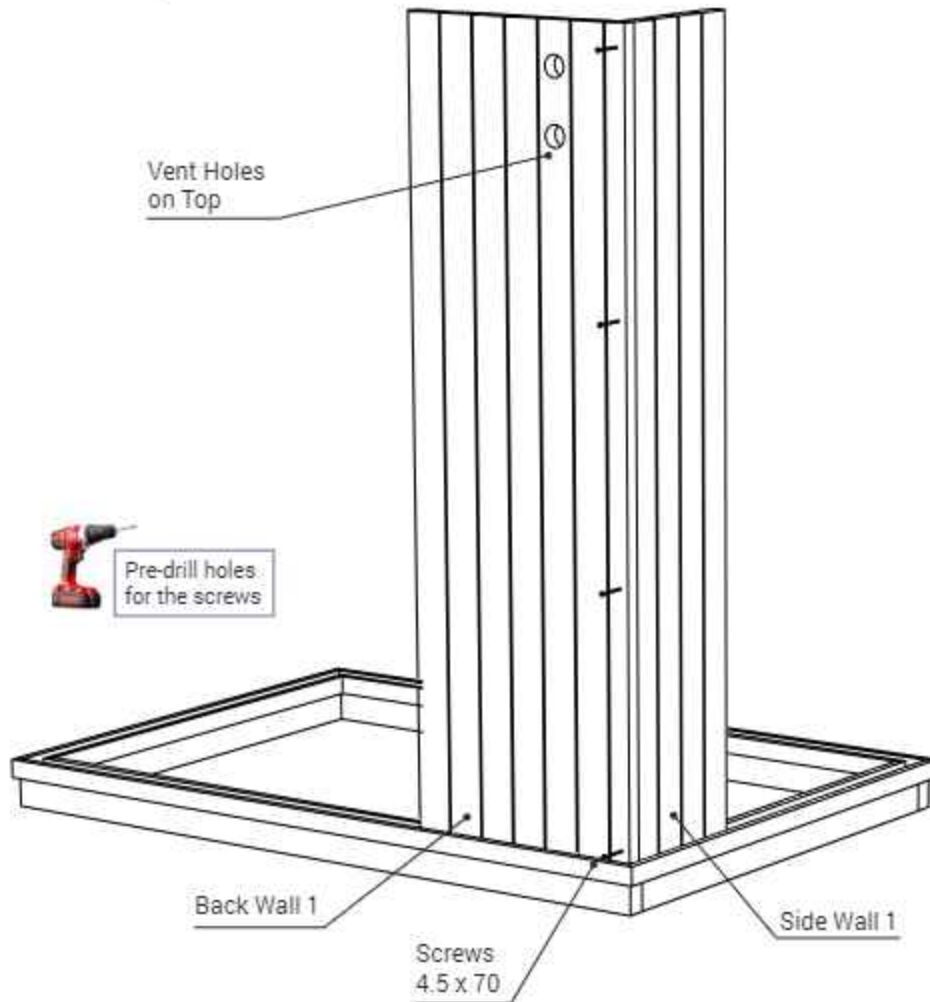

STEP 5.



Position Back Wall Sections 2 & 3, & Side Wall 1

Position Back Wall 2 section into the groove of the back rail. Attach it to Back Wall section 1 by way of the tongue and groove fit. Secure it by tapping it into place with a rubber mallet. Repeat this step for Wall Section 3, again tapping it into place with a rubber mallet. Position Side Wall Section 1 into the groove to the right side rail and push flush against the back wall. Be sure panels are flush with each other. Fasten them using 4.5 x 70 screws.

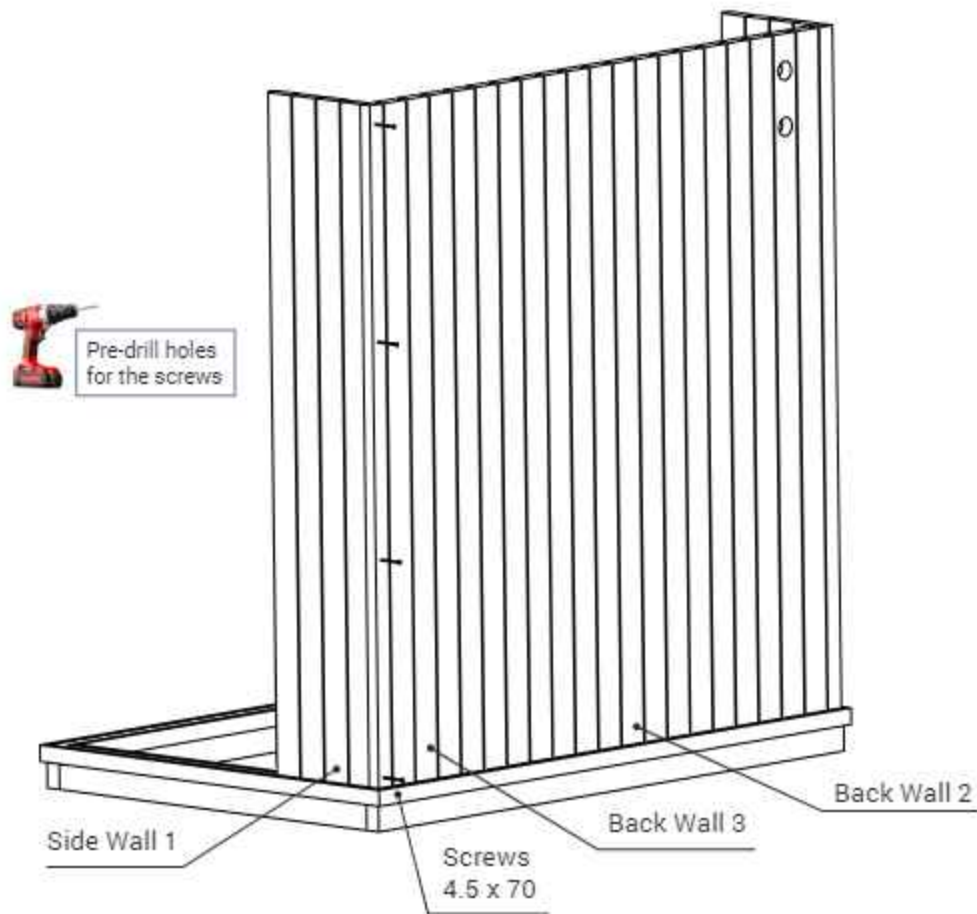

STEP 6.



Position Side Wall Section 2, Window Section & Door Section

Position Side Wall Section 2 into the groove of the side rail. Slide Side Wall Section 2 into place with side Wall Section 1. Section 2 connects to Section 1 via tongue and groove so there is no need to use screws. Use a rubber mallet to secure the fit.

Place Window Section in the groove on the front rail and push against side rail. Be sure the two sections are flush and fasten them using 4.5 x 70 screws.

Place Door Section onto the front rail orienting it so that the door opens according to your preference. Door Section connects to Window Section via tongue and groove so there is no need for screws. Gently tap it into place with a rubber mallet to secure the fit.

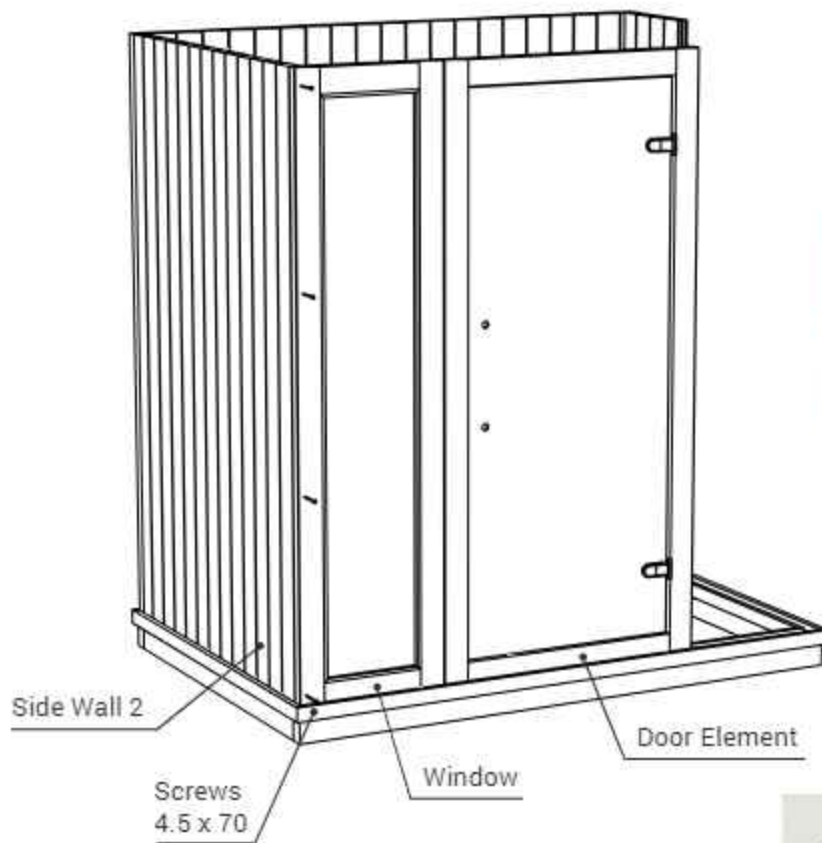

STEP 7.

Position Side Wall Section 3 & Window Section

Position Side Wall Section 3 into the groove of the side rail so that the heater vent holes are located at the bottom. Slide wall section into place with Side Wall Section 1. Side Wall 3 connects to Side Wall 1 via tongue and groove so there is no need to use screws. Use a rubber mallet to secure the fit.

Next, place the Window Section into the groove of the front rail and connect it to the Door Section via the tongue and groove fit. Gently tap into place with a rubber mallet to secure the fit.

Now, making sure Window Section and Side Wall 3 are flush with each other, secure them with 4.5 x 70 screws.

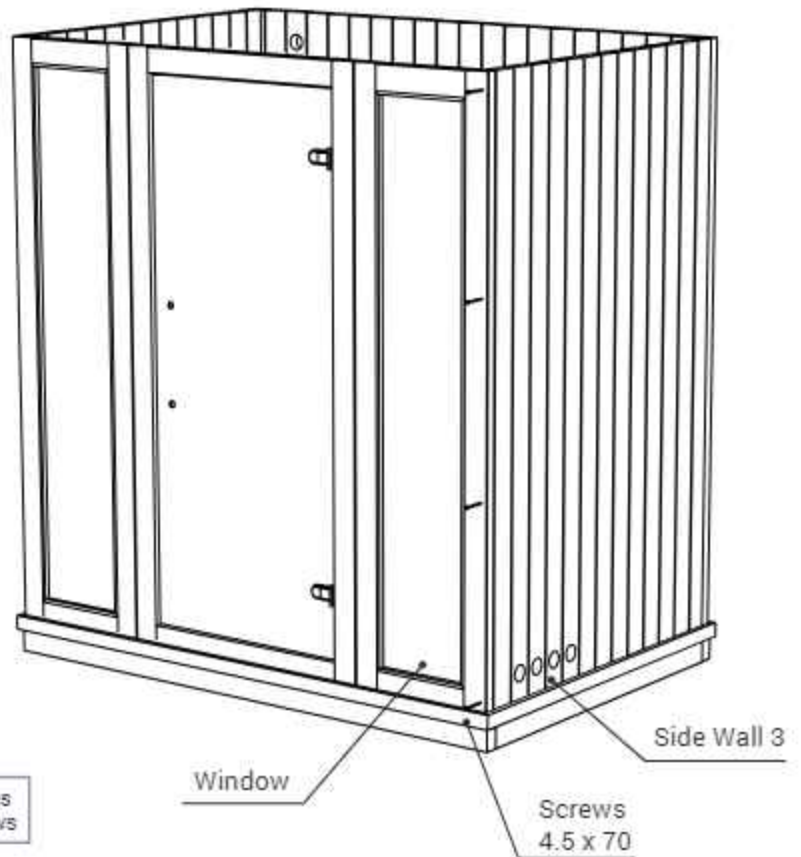

Pre-drill holes
for the screws



STEP 8.



Assemble & Position Roof Support Rails

Connect Roof Support Rails in the same way as Step 2. Place the assembly on top of the wall sections so that the wall sections fit snugly into the groove. When in place, secure to the assembly to the walls using four 4 x 50 screws on each rail.

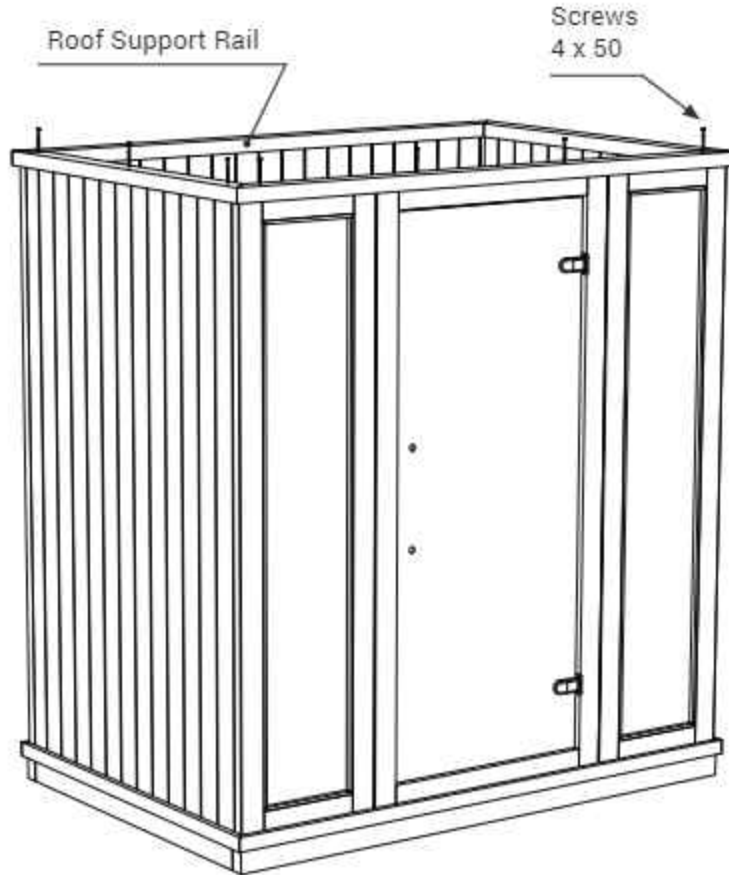

STEP 9.

Bench Installation

Use 4.5 x 70 screws to connect the Bench Supports to the wall. Make sure the supports in both walls are in same height. When the supports are assembled place the bench on the supports. Use three 4.5 x 70 screws to connect the seat bench to the back wall.

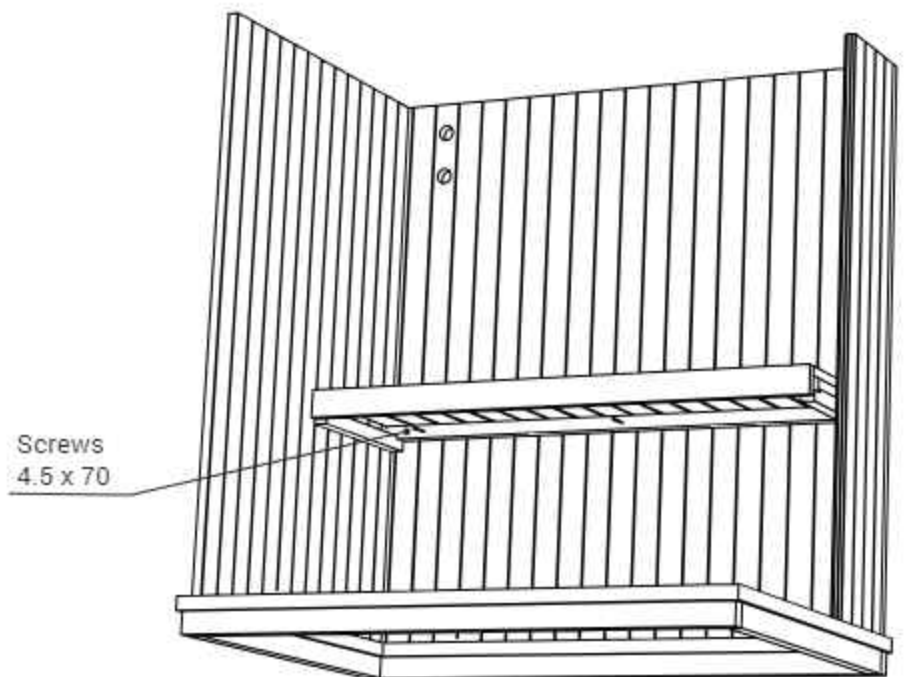
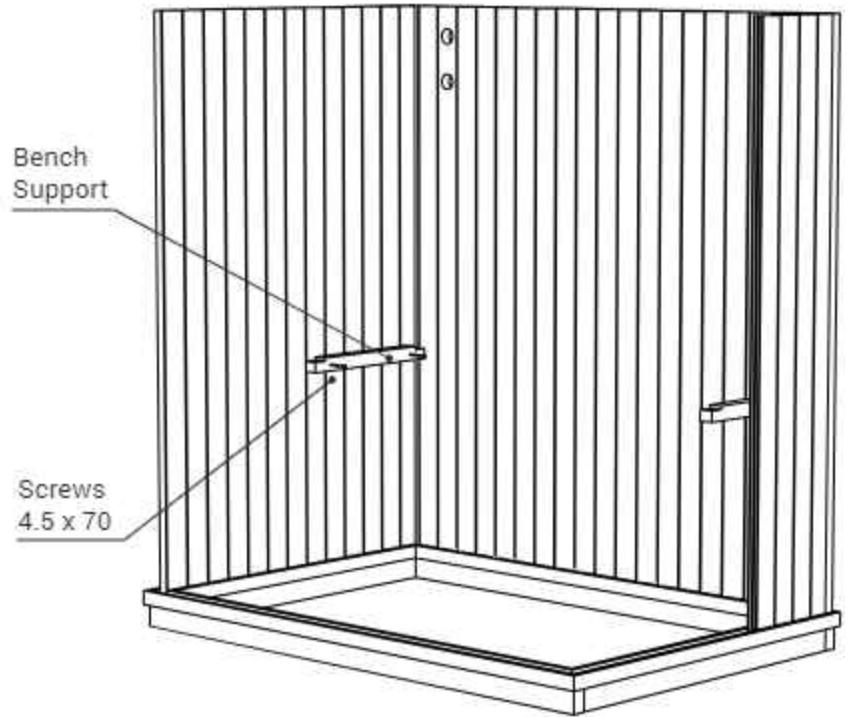
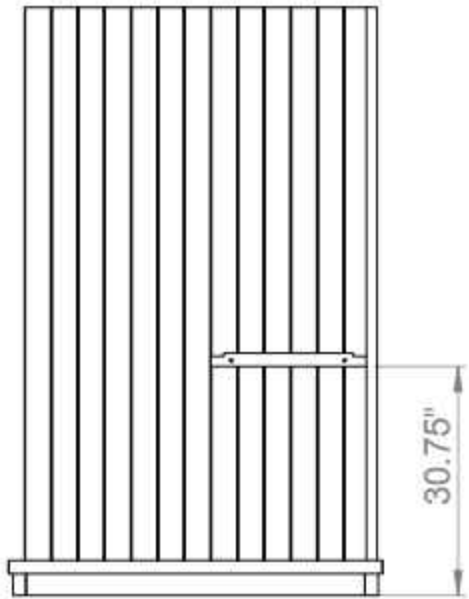

STEP 10.



Side Bench Installation

Attach the Side Bench Support 1 to the back wall using two 4.5 x 70 screws. Side Bench Support 2 connects to the Window Section using 4 x 60 screws. Place the side bench on the supports and fasten it with three 4.5 x 70 screws to the side wall element.



Pre-drill holes for the screws

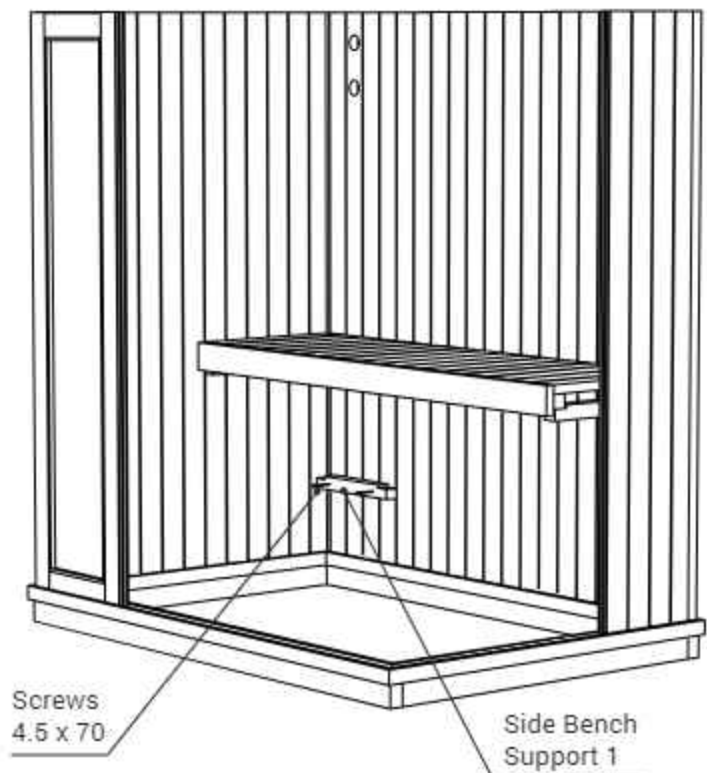
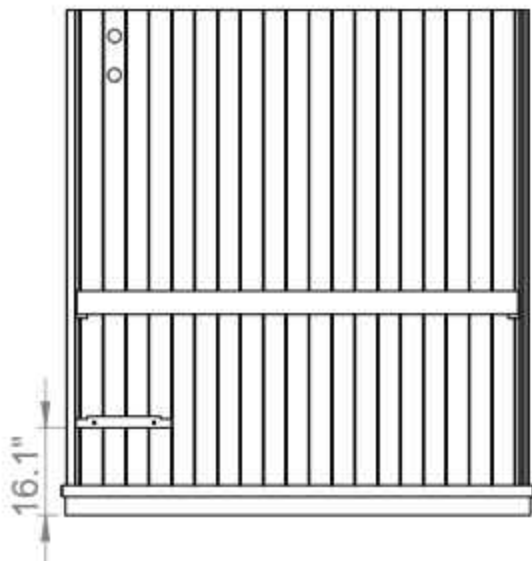

X6 Sauna Model

Installation & Owner's Manual

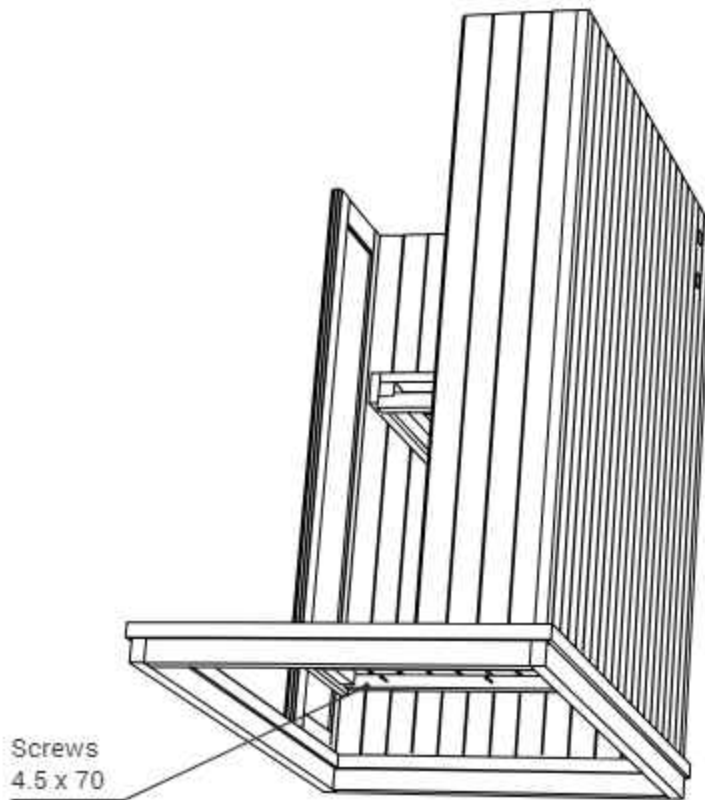
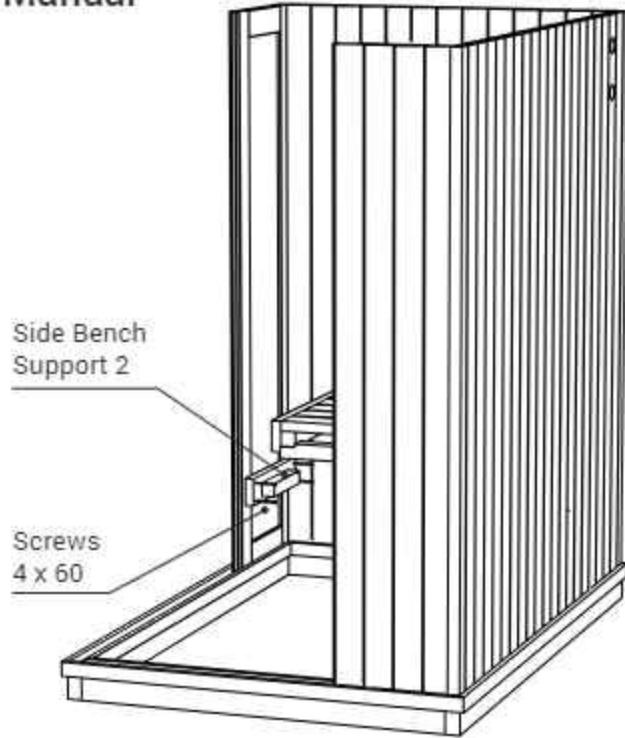



STEP 11.

Backrest & Lower Backrest Installation

Center the Backrest between the two sides and position it vertically at a height most comfortable for you (typically 8-12" from the bench).

Using a level to ensure proper installation, fasten the Backrest into place using 4 x 60 screws. Using a level, secure the Lower Backrest to side wall section with 4 x 60 screws at the same height above the upper long bench.



Pre-drill holes
for the screws

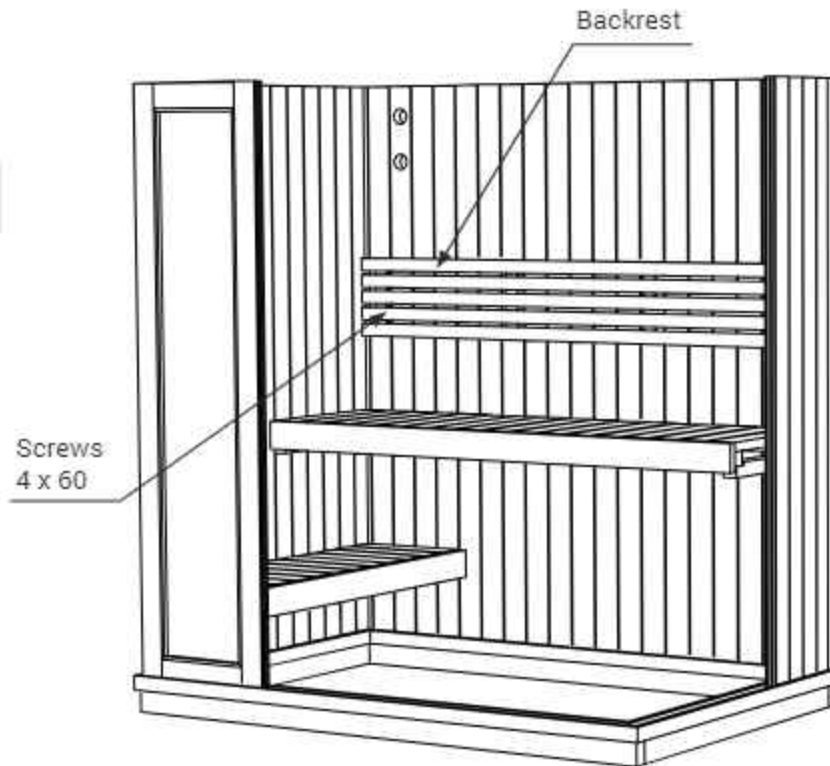

X6 Sauna Model

Installation & Owner's Manual

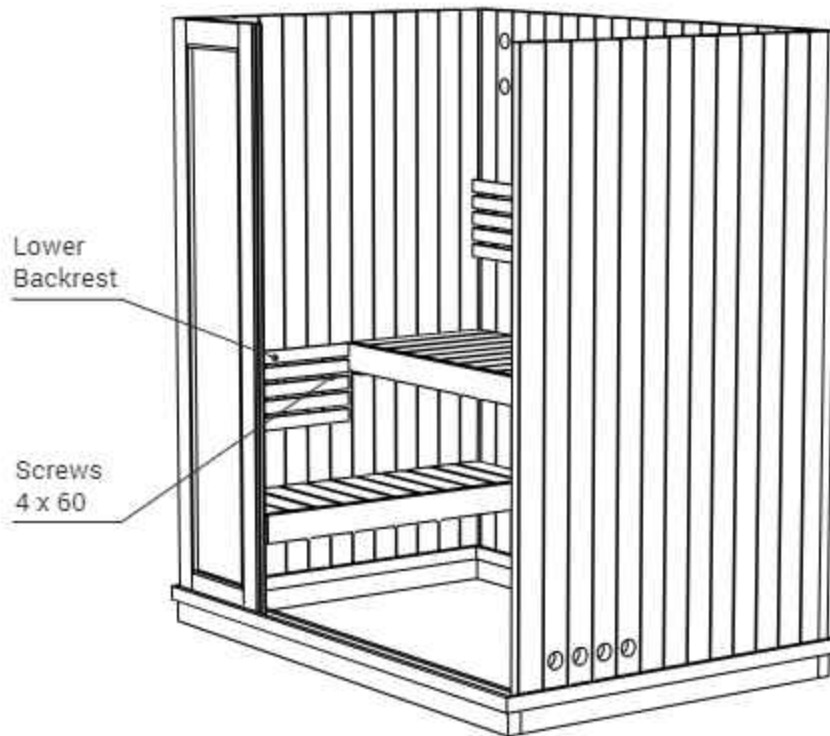



STEP 12.

Position Roof Sections

Place the Roof Panels on top of the ceiling supports. Connect the sections via the tongue and groove fit. From the backside, roof panels must be in the same line with ceiling supports. Position the both sides equally 1.875". Connect panels with 4 x 50 screws.



Pre-drill holes
for the screws

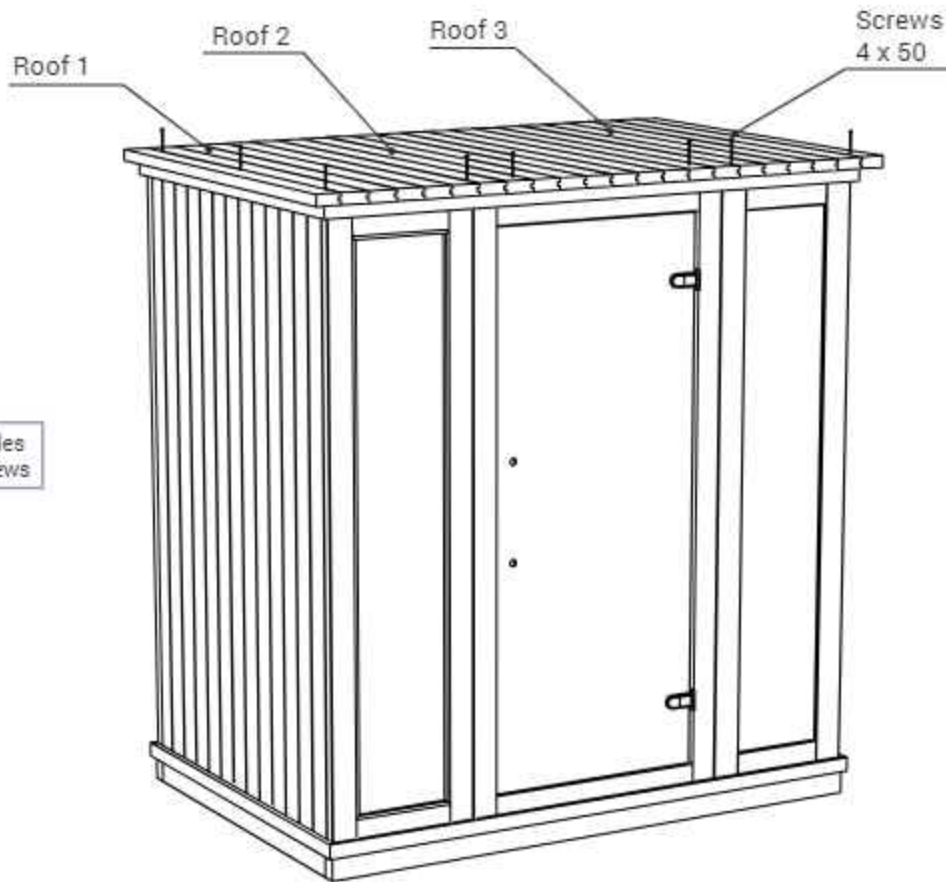

STEP 13.

Cornice Boards

Connect the Cornice Boards to the roof, using 3.5 x 40 screws.

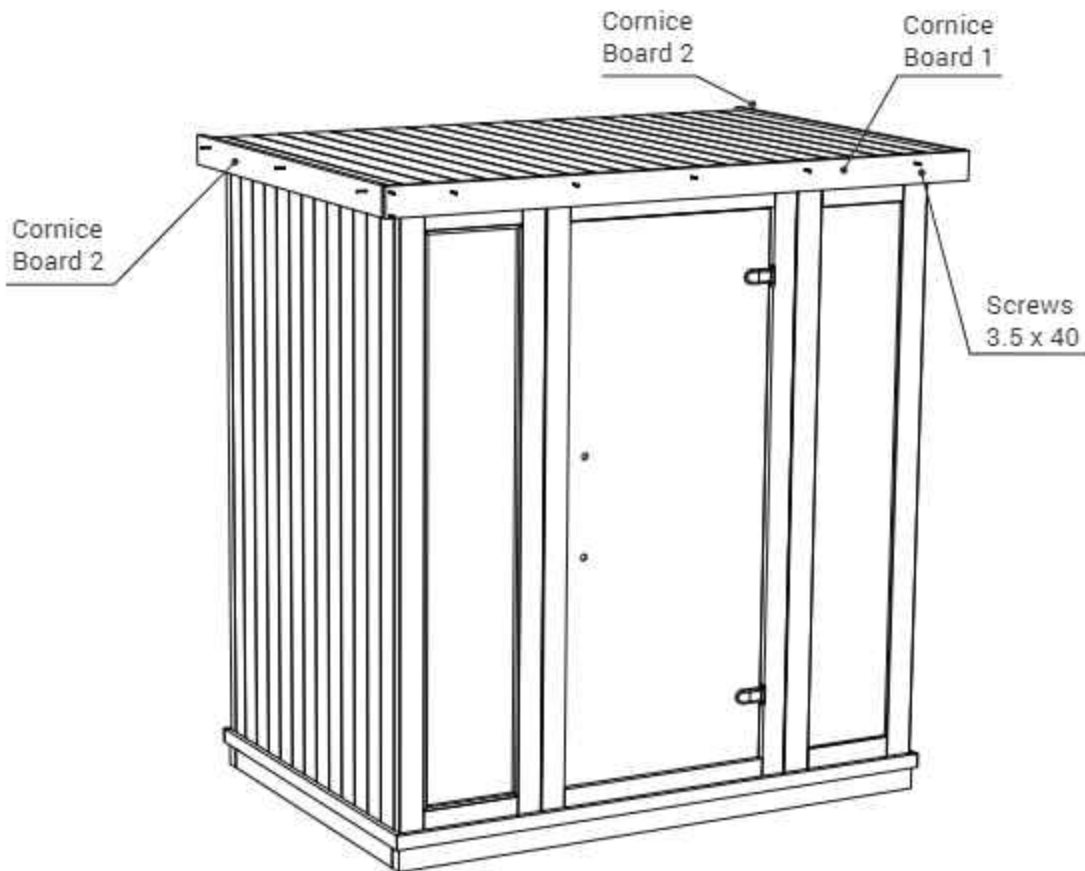



STEP 14.

Cover Slats to the Front Wall

Connect the Cover Slats using 3.5 x 40 screws



Pre-drill holes for the screws

Cover Slat

STEP 15.

Heater Fence

Connect the Heater Cover to the wall with 4 x 60 screws. Perform this step after heater is installed.

Note: Follow heater manufacturer recommended installation for heater guard.

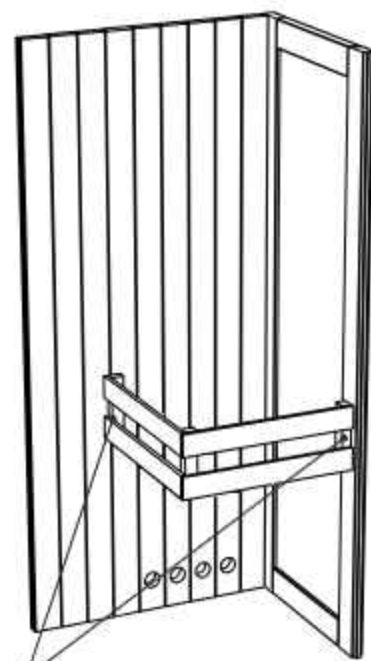

Screws
4 x 60



STEP 16.

Vent Cover & Door Handle

Connect the Vent Cover with 3.5 x 40 screw. Between wall and Vent Cover add small washer.

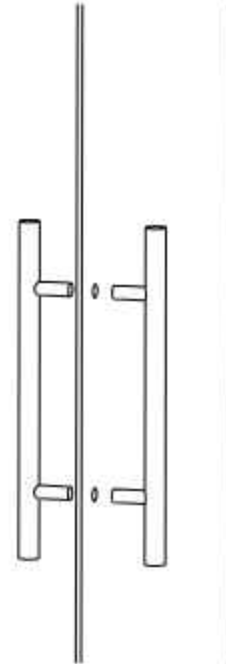
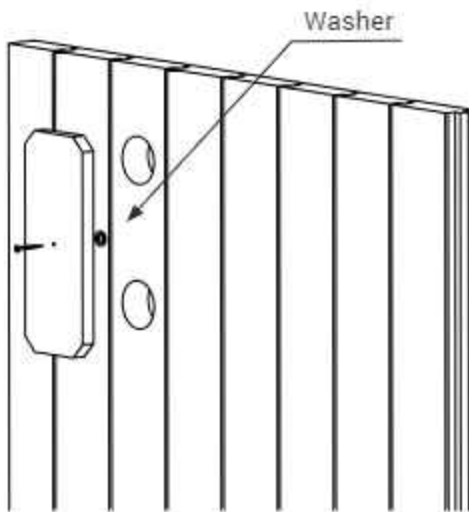



STEP 17.

Foot Rest Installation

Connect the Foot Rest with 4.5 x 70 screws from one side to the Side Bench and from the other side to the side wall. Two screws per side. Measure from front wall must be 22.14"

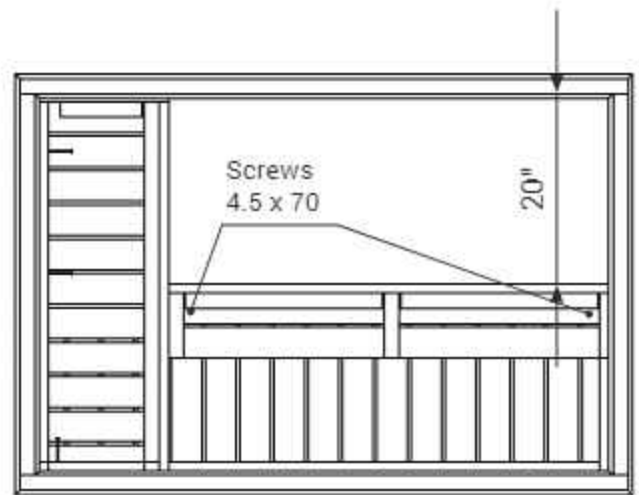
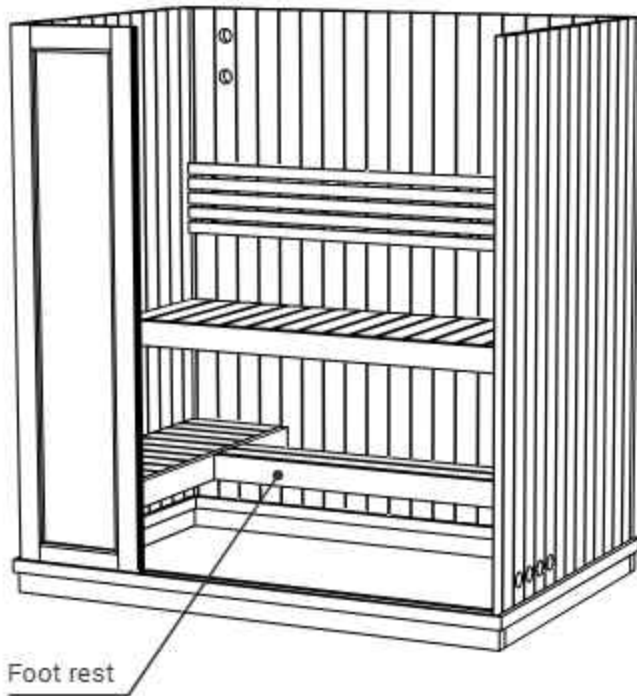

Floorplan View

