

VARLA

EAGLE ONE PRO

Owner's Manual

varlascooter.com

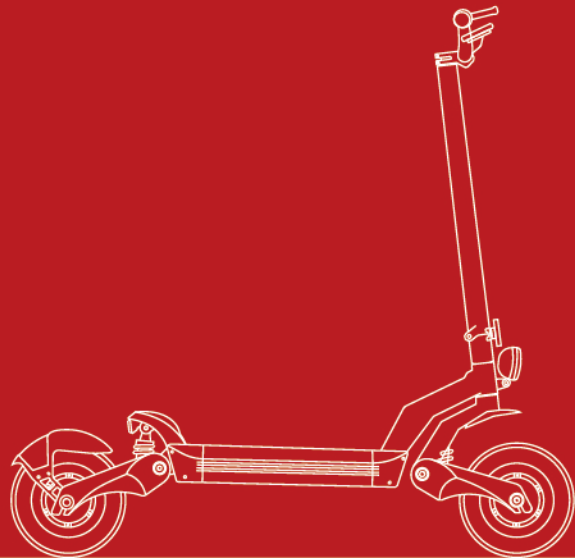

Foreword

Dear Customer,

Thanks for choosing Varla Scooter!

We sincerely hope you could enjoy the fun and freedom of riding Varla Scooter.

Please spend some time reading and understanding this entire manual before you ride.

Safety always comes first. You will work out how to ride your electric scooter quickly, however, remember to practice riding in a safe place with limited obstacles. Here are some key points to keep in mind when riding:

1. Wear flat shoes. Please do not wear flip flops or sandals while riding.
2. Please wear a helmet during the riding, as well as other protective equipment, such as, elbow and knee protectors and padded gloves which will allow a firmer grip on the handlebars.
3. Please look ahead while riding! This may sound a little bit silly but people could be distracted by their surroundings. Be careful!
4. Make sure you're familiar with the scooter's functions.
5. DO NOT play your phone while riding.
6. DO NOT ride your scooter in the heavy rain or wet conditions as this could damage the battery and it will not be covered by the warranty for water damage.
7. DO NOT violently hit the deck and other parts deliberately as this could damage the battery and frame and it will not be covered by the warranty.
8. If you ride in the dark, please wear visible and reflective clothing.
9. Do not modify the electric scooter at will.

These are some basic tips, now start your learning of the scooter in details!

CONTENTS

Safety Warnings	1
Product Specifications	3
Product Dimensions	4
Electric Scooter Parts	5
Assembly	6
General Operation	10
Accessing Settings	14
Pre-Ride Checklist	18
Warranty and Contact Information	19

Safety Warnings

- ☆ Riding an electric scooter does present potential risks and caution is required. Like any vehicle, an electric scooter has inherent hazards associated with its use (for example, falling off or riding it into a hazardous situation).
- ☆ The recommended minimum rider age is 16 and older. Any rider unable to fit comfortably on the scooter should not attempt to ride it.
- ☆ Keep this product away from small children and remember that it is intended for use only by persons who are, at a minimum, completely comfortable and competent while operating the scooter.
- ☆ Do not exceed the weight limit of 330 lbs. Rider weight does not necessarily mean a person's size is appropriate to fit or maintain control of the scooter.
- ☆ Check and maintain scooter conditions. Before use, check to confirm that covers and guards are in place and in serviceable condition. The scooter should be maintained and repaired in accordance with the manufacturer's specifications, using only the manufacturer's authorized replacement parts, and should not be modified from the manufacturer's original design and configuration.
- ☆ Obey the local laws or regulations.
Always check and obey any local laws or regulations which may affect the locations where the electric scooter may be used. Keep safely away from cars and motor vehicle traffic at all times. Only use where allowed and with caution.
- ☆ Wear proper protective equipment while riding.
Always wear proper protective equipment, such as an approved safety helmet (with chin strap securely buckled), elbow pads and knee pads. A helmet may be legally required by local law or regulation in your area.
- ☆ Don't switch Single/Dual-mode during riding!
- ☆ When riding in gear 2 and above, you need to break the front and rear brakes together.

Safety Warnings

1



1. Please wear a helmet during the riding and other protective gear, such as elbow and knee protectors.

2

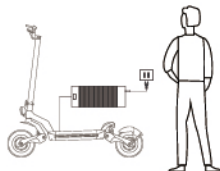

2. Charge the battery with the original charger, and someone needs to be nearby to avoid accidents when charging.

3

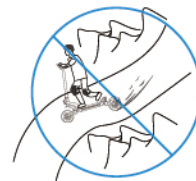

3. Do not ride on bumpy and slippery roads, such as dirt road, gravel road, snow-piled and gathered water road.

4



4. Do not ride your scooter in the heavy rain or wet conditions as this could damage the battery.

5



5. Dangerous actions are prohibited while riding.

6



6. Do not ride with one hand.

Product Specifications

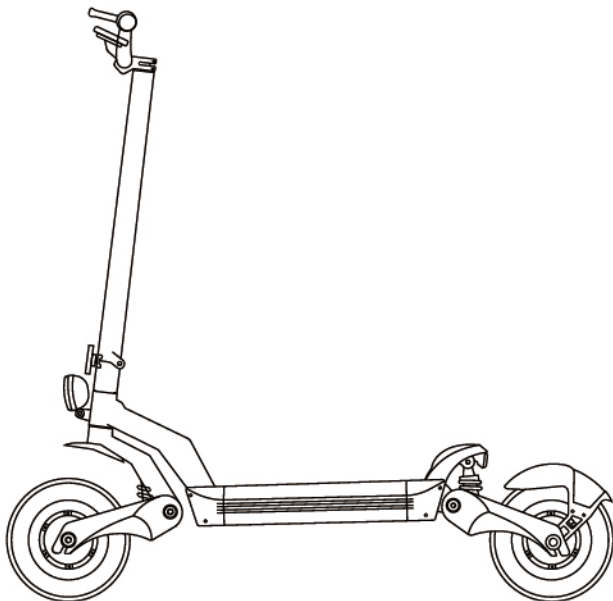

Motor	2x1000W
Speed	45 MPH
Climbing Angle	30+ Degrees
Battery	60V/27Ah Battery
Max Range	45 Miles (depends on riding condition)
Brake	Dual Hydraulic Brake
Tire	11 inches Air Tubeless Tires
Display	3.5 inches LCD Display
Key	NFC Card
Frame Material	Aluminum+Magnesium Alloy
Suspension	Dual Suspension
Throttle	Thumb Throttle
Payload Capacity	Max. 330 lbs Recommended 250 lbs
Self Weight	90 lbs
Deck Pad Material	Silicone
Light	10W Headlight & Red Taillight
Waterproof Rating	IP54

Product Dimensions

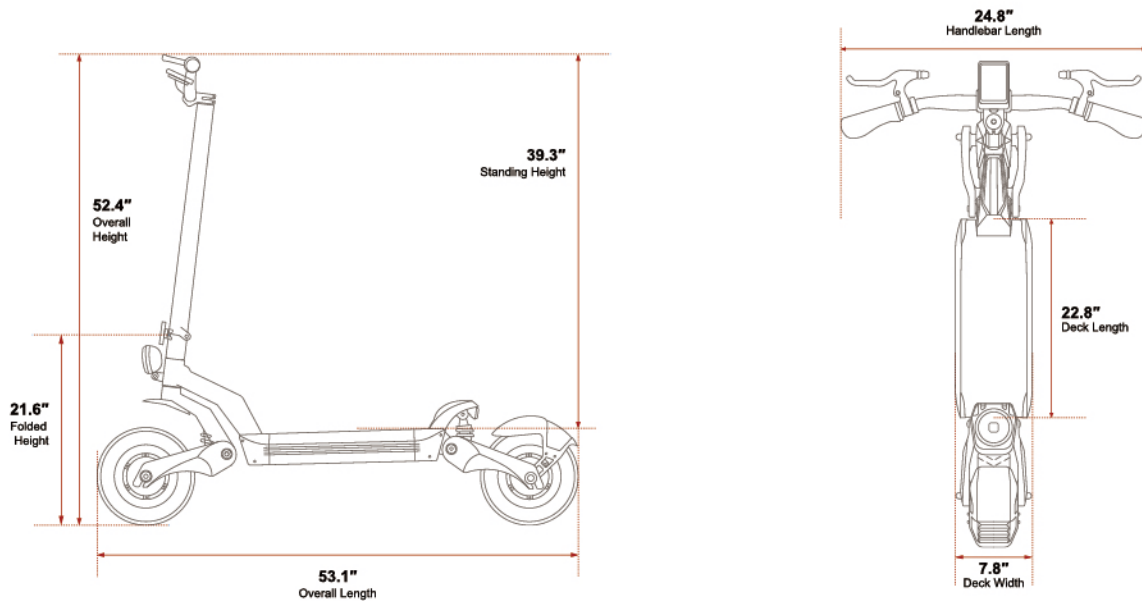

To improve quality and safety of the product, the specification might be changed without prior notice.

Electric Scooter Parts

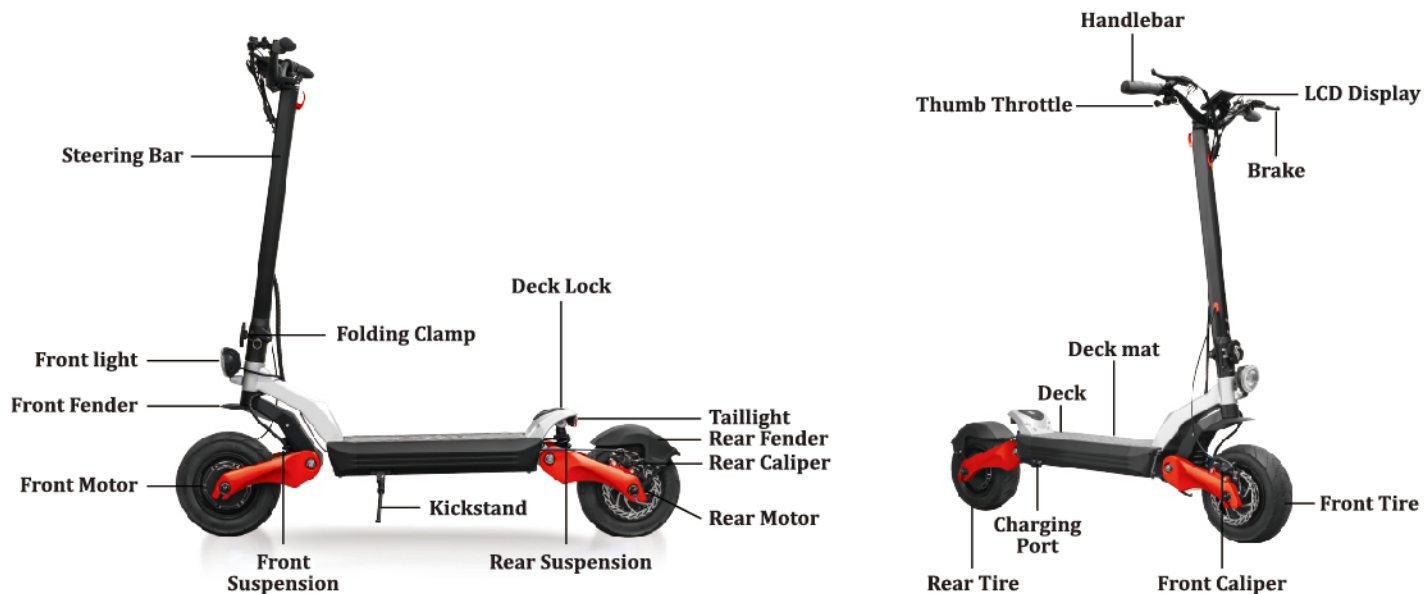

1

Put the handlebar on the stem, align center.

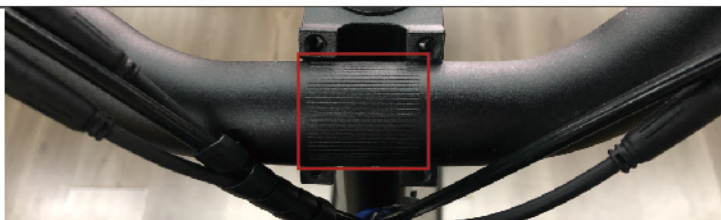

2

Put the cover and tighten the screws at both ends.

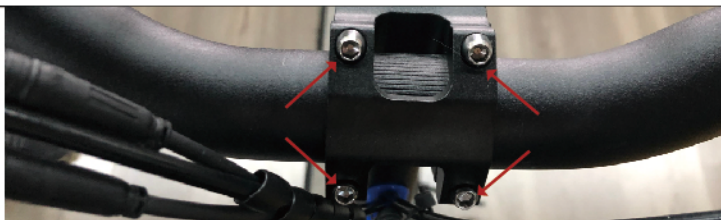

3

Install the LCD display, adjust to appropriate angle, and tighten the fix screws.



4



When connecting these two connectors, the arrow must be aligned with the arrow. You can turn on the power only when the assembly is completed.

How to Unfold the Scooter



How to Fold the Scooter



Dashboard

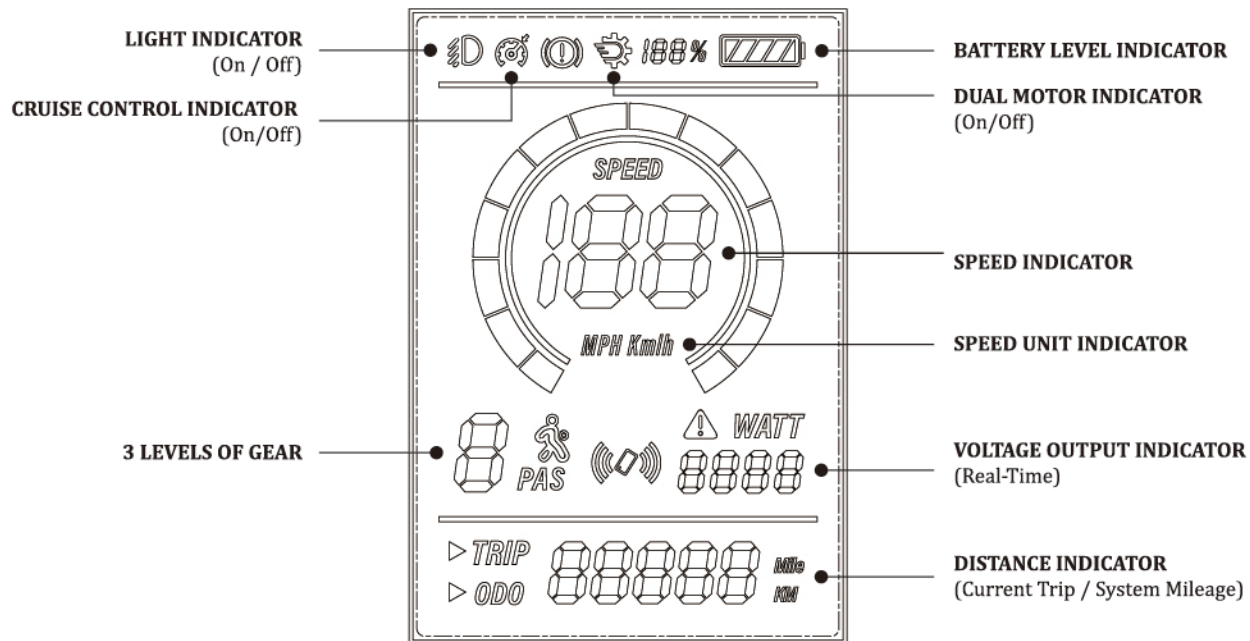

General Operation

☆ Riding Methods

When the power is on, it will show PAS 1, the top speed is 15 mph;
Press the “+” button, it will show PAS 2, the top speed is 25 mph;
Press the “+” button twice, it will show PAS 3, the top speed is 45 mph;

☆ Power Switch

Press and hold the Power button for 3 seconds to turn on the LCD Display.

1

Press and hold the Power button for 3 seconds to turn on the LCD Display. Then you will see the card logo on the screen.





2

Place Vala's NFC card at the designated location on the dashboard and the scooter will be successfully unlocked.



General Operation

☆ Dual/Single Motor Switch

When it shows “” (Dual Motor Mode) on the display, press and hold “+” button for 2 seconds to enter Single Motor Mode, then the “” doesn't show on the display.



**Don't switch Single/Dual-mode during riding!*

☆ Light

- Headlight: Long press and hold “” button for 2 seconds to turn on/off the headlight.
- Taillight: When you brake, the taillight will flash.



**Please turn on the headlights for night riding!*

☆ Cruise control

Press and hold the thumb throttle to maintain a fixed speed for more than 8 seconds to automatically enter cruise mode. Then, you will see “” on the screen.

☆ Battery

- Balance the charge protection: balance the cell voltage automatically to protect the battery.
- Overcharge protection: overcharge would damage the battery severely. Our battery would stop charging after been fully charged.
- Charging temperature protection: when the charging temperature is below 5 degrees celsius or over 40 degrees celsius, it will harm the battery, and may cause the battery to not be used normally.
- Charging over current protection: High current charging will seriously damage the battery.
- Short circuit protection: when the battery detects a short circuit, it will cut output to protect the battery.
- Battery sleep protection: when the battery is on, but there's no connection to any electrical equipment.
- Battery life can vary depending on proper maintenance and usage of the scooter.
- Please only use the recommended charger.

☆ Charger

Make sure the power is turned OFF before you charge it.

Step 1 Plug the charger into wall outlet.

Step 2 Plug the charger into the charger port. The light on the charger should turn red during charging. The light will turn green again when charging is complete.



Make sure the notches on both ends are aligned.

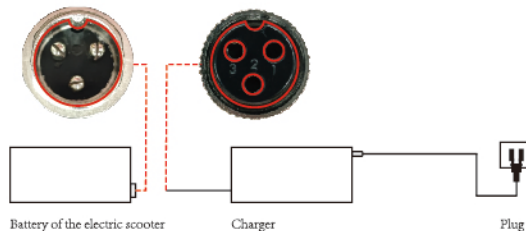

☆ Note:

Charger getting warm during use is normal. If your charger does not get warm during use, it does not mean that it is not working properly.

Don't charge the scooter immediately after a long-distance ride. Please wait for at least 30 minutes.

Continue charging the scooter even if light turns green prior to 12 hours.

Before riding, check the current voltage on the display. When the voltage is lower than 55V or the battery bar is only one bar, it means the battery is about to run out. Please charge the scooter as soon as possible.



**Battery can deplete over time. Periodically recharge battery once per month when not in use for a long time.*

☆ How to connect the NFC key with your phone?

- Open the Settings app.
- Tap Connections.
- Tap the switch to turn NFC on.
- Select your preferred app and follow the on-screen instructions to finish setting it up.



*Device needs to support NFC
*It's not available for iPhone.



Accessing Settings

- Long press the “+” and “-” button at the same time to access the P-setting menu.
- Press the Power button to toggle through P-settings.
- Use the +/- button to adjust the value.
- To save settings, allow the LCD display to timeout (8 seconds) or long press “+” and “-” button to exit the menu.



P-Setting Instruction

Setting	Feature	Notes
P00	Rim size (do not adjust)	Default: 11
P01	Battery voltage (do not adjust)	Default: 60V
P02	The number of magnetic poles (do not adjust)	Default: 30
P03	Speedometer units	0: kph 1: mph Default: 0
P04	Start mode	0: zero start 1: kick start Default: 0
P05	Cruise control	0: off 1: on Default: 0

P-Setting Instruction

Setting	Feature	Notes
P06	Start strength (do not adjust)	From 1-5 1: the weakest 5: the strongest
P07	Power level	From 0-80 Default: 80
P08	ABS level	From 0-2 Default: 1
P09	NFC card connect setting	From 0-2 Default: 2
P10	ODO reset	Default: 0 Select "1" to reset the ODO

LCD Display Error Code:

- 006 Battery under voltage
- 007 Motor faulty
- 008 Throttle faulty
- 009 Controller faulty
- 010 Communication receive faulty
- 011 Communication sending faulty

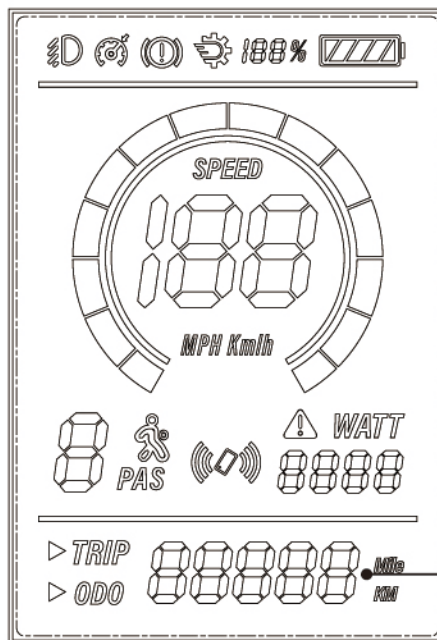

ERROR CODE INDICATOR
(In the Event of a Problem)

Pre-Ride Checklist

☆ Brake

Check the brake kits for proper function. When you pull the brake lever, the brake should provide positive braking action.



**When riding in gear 2 or above, the front and rear brakes must be braked together when you brake!*

☆ Tire

Periodically inspect the tires has sufficient tread remaining.

☆ Battery

Before riding, check the current voltage on the display.

☆ Frame and handlebar

Check for cracks or broken connections. Although broken frames are rare, it is possible for an aggressive rider to run into a curb or object and wreck, bend or break a frame.

☆ Safety gear

Before the ride, please wear your helmet, gloves, elbow protection, waist protection and other protective gears.

☆ Law and regulations

Always check and obey any local laws or regulations.

☆ Storage

Exposure to UV rays, rain and other bad weather may damage the materials, store cool and dry indoors when not in use.

Warranty and Contact Information

Your purchase includes the following warranty.

The warranty would be registered automatically when the initial purchaser ordered it in the online shop. The warranty is ONLY under the INITIAL PURCHASER. The 2-year warranty would be started since the initial owner receives it.

Affected Part	Warranty Period	Service Content
Throttle	24 months	Free maintenance
Controller	24 months	Free maintenance
Frame	24 months	Free maintenance
Motor	12 months	Free maintenance
Battery	12 months	Free maintenance
Charger	12 months	Free maintenance
Kickstand	1 Month or 100KM	Free replacement
Fenders	1 Month or 100KM	Free replacement
Aesthetic Damage	Not Covered	-

HOW TO MAKE A WARRANTY CLAIM

If you believe your Varla scooter has a warranty issue, your first point of contact should be your Store where you purchased. If you purchased directly from Varla Online Store, please contact our customer service team: customer@varlascooter.com.

Warranty Notes

During the warranty period, any damage caused by the following reasons will not covered by the warranty:

1. Failure to follow this instruction manual for maintenance.
2. Incorrect use or traffic accident or other accidental collision damage.
3. Use damaged or other accidental collision when driving on abnormal condition roads.
4. Rapid aging and malfunction due to a long time sun exposure or leave the scooter outdoors for a long time.
5. The use of electric scooters for other purposes to perform dangerous actions such as special effects, which leads to rapid aging and malfunction of this product.
6. Natural disasters, man-made irresistible reasons cause vehicle damage.

Note: Please visit Varla's official website for the latest after-sales, return policy, warranty information, etc.

Official Website: varlascooter.com



WARRANTY CARD



WARRANTY CARD

Please complete the following details.

Owner's Name: _____

Address: _____

City: _____ State: _____ Zip Code: _____

Order Number(s): _____ Serial number(s): _____

Date of Purchase: _____

Phone number: _____ Email: _____

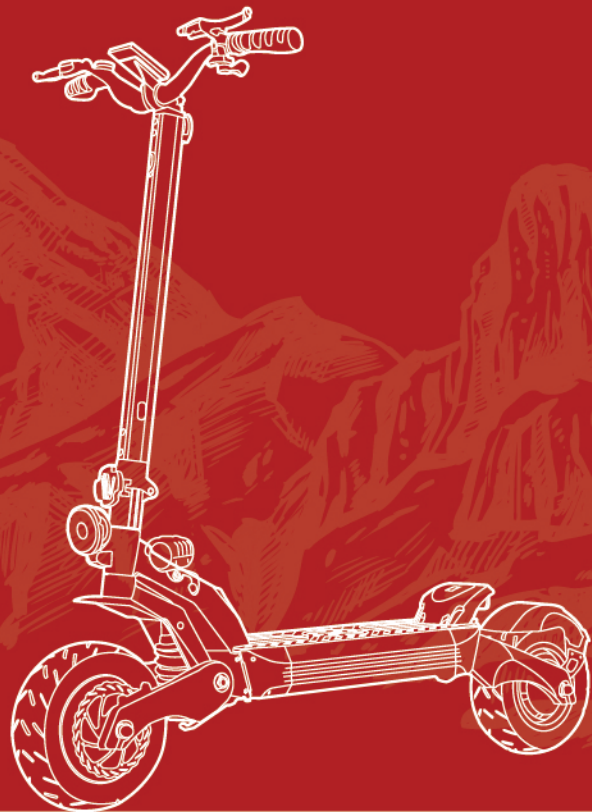

varlascooter.com