

# ***GAMMA***<sup>®</sup>

# **PROGRESSION**

## **602FC**

## **STRINGING MACHINE**



### **OWNER'S MANUAL**

Issue 7 - June 2014





# PROGRESSION

## 602FC

### MP62F-13 OWNER'S MANUAL

#### TABLE OF CONTENTS

WARRANTY .....	PAGE 3
FEATURES .....	PAGE 4
ASSEMBLY INSTRUCTIONS .....	PAGE 5
MOUNTING THE FRAME .....	PAGE 5
STRINGING THE FRAME .....	PAGE 7
PATHFINDER AWL .....	PAGE 11
MAINTENANCE .....	PAGE 12
TROUBLESHOOTING TIPS .....	PAGE 13
PARTS LIST .....	PAGE 14
PARTS DRAWING .....	PAGE 15

#### LIMITED WARRANTY

GAMMA SPORTS ("GAMMA") warrants to the original purchaser that the GAMMA PROGRESSION stringing machine ("EQUIPMENT") purchased is free from defects in materials and workmanship for a period of five (5) years from the date of original purchase for mechanical parts (excluding electrical parts and string clamps) and for a period of one (1) year from the date of purchase for all electrical parts and string clamps. Should any defects develop under normal use within the specified time periods, GAMMA will at its option, repair or replace the defective EQUIPMENT provided it is returned to GAMMA prepaid at the purchaser's expense. This warranty does not apply to any damage or defect caused by negligence, abuse, misuse, unauthorized alteration, shipping, handling or part wear and tear as a result of normal use.

GAMMA's obligation under this warranty is limited to repair or replacement of defective EQUIPMENT, and no one is authorized to promise any other liability. GAMMA shall in no event be liable for any incidental or consequential damages.

To return defective EQUIPMENT, a return authorization (RA#) must be obtained from a GAMMA customer service representative by calling 1-800-333-0337. The RA# must be marked on the outside of the shipping carton being returned. All returns must be shipped prepaid by the customer to GAMMA. Please retain the original shipping carton and packing materials for any future shipments. GAMMA will not be responsible for machines which are not sent in the original undamaged packaging.

A GAMMA Care Service Plan is also available through GAMMA customer service, call 800.333.0337 for details.

# FEATURES



## MACHINE FEATURES

- ❖ Drop Weight Tensioner with 9 to 90 lbs range and Permanently Engraved Weight Scale
- ❖ Patented Parallel Jaw Rotating Ratchet Gripper with Diamond Dust Coated Gripping Surfaces
- ❖ Professional Six Point “Quick Mount” Racquet Mounting System- Accommodates All Racquets
- ❖ Professional “Quick Action” Dual Action, Rotating, Metal Fixed String Clamps with Diamond Dust Coating
- ❖ Durable Polystyrene Base Cover with Convenient Padded Tool Tray
- ❖ Strong, Light Weight, Aluminum Construction

# ASSEMBLY INSTRUCTIONS

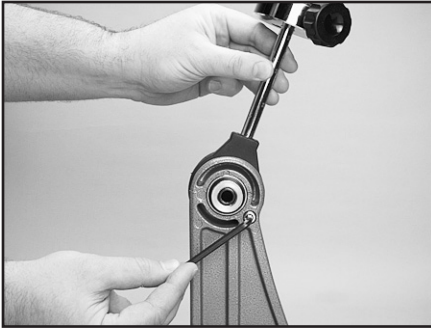

## Engaging the Drop Weight Bar Stop

The stringing machine is shipped with the drop weight bar in the horizontal position. To prevent racquet damage during stringing, the bar stop must be engaged.

Remove the machine base from the shipping carton being careful to avoid lifting by the plastic cover.

Hold the drop weight bar in the vertical position as shown while turning the stop screw clockwise with the supplied 5mm hex wrench.



## String Clamp Installation

The post of the string clamp head and tube of the string clamp base are treated with grease to provide protection against corrosion during shipping. Remove any excessive grease with a clean cloth prior to use. The post and tube may also be cleaned with isopropyl alcohol. After this type of thorough cleaning, the post and tube should be treated with a light coating of machine oil to protect the surfaces against corrosion and to ensure smooth operation.

# MOUNTING THE FRAME

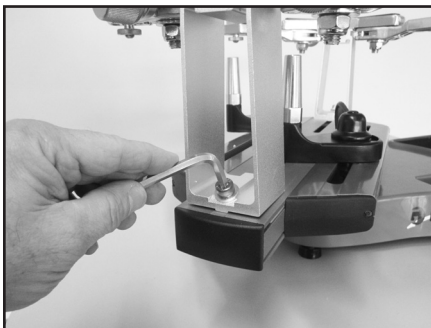

## Adjusting the Frame Support Posts

Place the racquet frame over the center posts and onto the frame support. Loosen the lever lock bolt on one support post. Slide the post outward until the center support of the racquet support slide is positioned near the inside surface of the racquet frame. Securely tighten the lever lock bolt.

Adjust the opposite post using the same procedure.

**Caution:** To avoid racquet damage, the center posts should not contact the racquet prior to fixing the support posts.

# MOUNTING THE FRAME



## Tightening the Center Supports

Tighten the Center Supports by turning the adjustment knob clockwise until slight resistance is felt.

**Caution:** Overtightening the Center Supports may cause racquet damage.



## Frame Shoulder Support Arm Adjustment

Being sure the shoulder supports are free to swivel in their mountings, simultaneously rotate the shoulder support adjustment knobs clockwise until both shoulder supports gently and squarely contact the frame.

The shoulder supports are designed to rotate and can be adjusted to provide maximum support to the racquet frame. Rotate the support so that the pads contact the frame squarely when the arms are closed against the racquet.

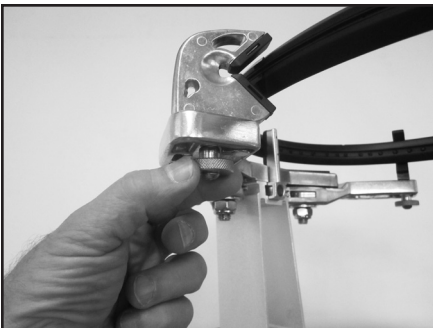

## Securing the Frame

Lock the shoulder supports in position by turning the knob at the base clockwise.

Repeat the adjustment procedure for the remaining support post.

Re-tighten all of the frame supports in the same order as before.

**Do not overtighten any of the supports as racquet damage may occur.**

The supports should be tightened to the point where the racquet frame will not move in the mounting system when the handle is grasped and attempts are made to move it. Should any supports lose contact with the frame while stringing, they should be re-tightened.

# STRINGING THE FRAME



## Setting Tension

To set the stringing tension, loosen the locking knob on the side of the drop weight. Slide the weight in the appropriate direction until the face **closest** to the string gripper is indexed with the desired tension mark on the tension bar.

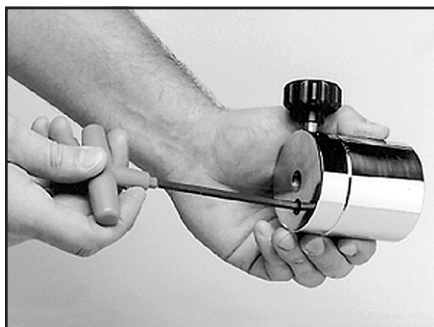

The drop weight is of a two piece design. When assembled, it will accommodate tensions from 20 to 90 lbs. For tensions from 8 to 20 lbs., remove the 5mm bolt on the face of the drop weight, and use the smaller portion of the weight as described above.

**Note:** Tensions above 77lbs. require removal of the drop weight bar end cap.



## Fixed Clamp Operation

The fixed clamps are of a dual action design. The string clamp and the clamp base operate independently of one another.

To clamp a string, lift the clamp head and place the string between the jaws. Depress the clamp head lever to secure the string. The clamping pressure applied to the string should be adjusted to provide sufficient pressure to secure the string when subjected to the desired pulling tension.

The diamond coated gripper plates provide for increased friction between the clamps and the string to allow for reduced clamping pressure while securing and holding the string under tension.

**Note:** If the string slips in the string clamp while tensioning, adjust the gap between the clamp jaws as per the instructions on page 12.

# STRINGING THE FRAME



## Base Clamp Operation

Rotate the lever lock clockwise to secure the clamp base to the turntable.

Reverse the clamping procedure to unlock the string clamp.

The lever should be tightened enough to prevent clamp base slippage on the turntable, when the desired tension is placed on the string. To go from the loose position to the clamped position and back, generally requires about 1/2 to 3/4 quarters of a turn. Although when stringing at extremely high tensions, additional tightness may be required.

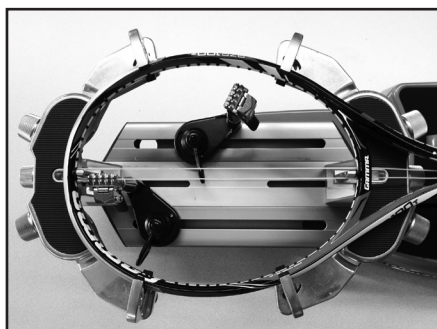

## Getting Started

To begin stringing the main strings, thread the two ends of the string through the two center holes at the appropriate end of the frame and continue through the opposite center holes. Thread one end of the string through the adjacent grommet hole and pull excess by hand.

Secure one of the strings using a string clamp.

Handy tip: The tear drop shaped holes towards the back of the shoulder supports are handy for holding the loose end of the

string while tensioning the string. Simply insert the loose end into the tear drop shaped holes and slide the string toward the point of the hole.

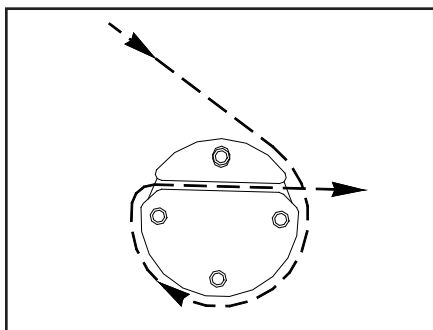

## Gripping the String

While holding the tension bar slightly above horizontal, wrap the free string clockwise around the gripper drum once and position between the gripper jaw.

Gently turn the gripper clockwise while squeezing the jaws together until all slack in the string is removed.

**Note:** For proper operation, the string gripper jaw must be in the position shown. The tension in the string provides the clamping force to the jaws.



# STRINGING THE FRAME

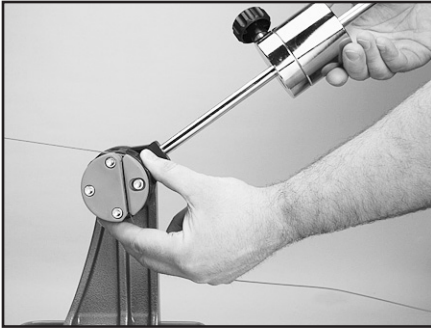

## Pulling Tension

While securely holding the string gripper drum with your hand, lift the tension bar above horizontal and gently lower the bar under its own weight. If the tension bar drops below horizontal, repeat the above action until the bar comes to rest parallel to the racquet.

***WARNING: TO AVOID INJURY, KEEP FINGERS AWAY FROM GRIPPER JAWS WHILE TENSIONING STRING.***

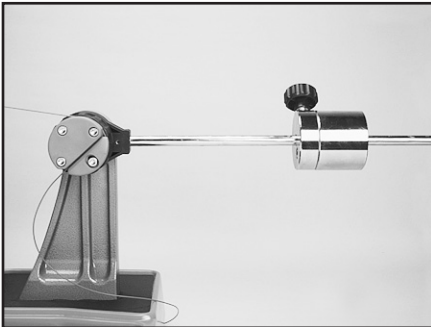

When the correct tension is attained, the drop weight bar will rest horizontally as shown. For accurate tensioning, it must be lowered and come to rest at horizontal without assistance. Manually forcing the tension bar to the horizontal position will greatly increase the string tension and may result in racquet damage. If the tension bar comes to rest above horizontal, release the string by lifting the bar and re-pull the string.

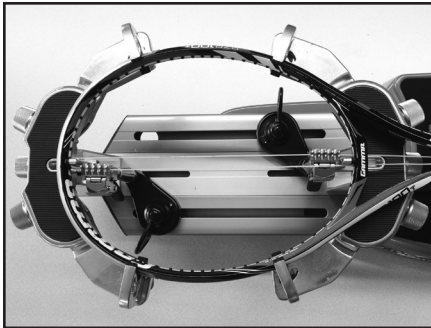

## Clamping the First Main String

Secure the tensioned main string using the second fixed clamp. Repeat the procedure for all of the remaining main strings and tie off at the appropriate hole following the racquet manufacturers specification.

Follow the racquet manufacturer's recommended stringing pattern for one or two piece stringing. This will determine the starting point for the cross strings. If applicable, tie the first cross string using an appropriate starting knot.

# STRINGING THE FRAME

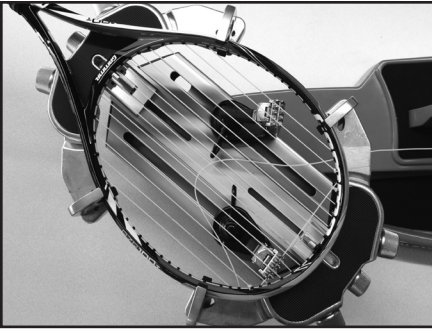

## Weaving the Cross Strings

Weave the cross strings over and under the main strings being careful to alternate the weave direction of each consecutive cross string so as to be opposite of the previously installed cross string.

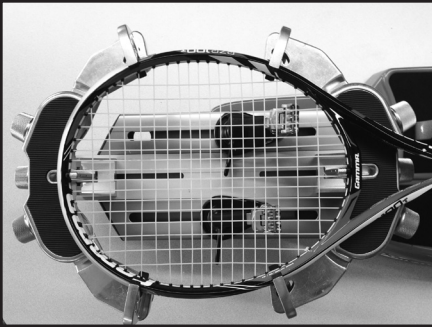

Once the final cross string is tensioned and clamped, tie off at the appropriate hole specified by the racquet manufacturer.

# ADDITIONAL FEATURES

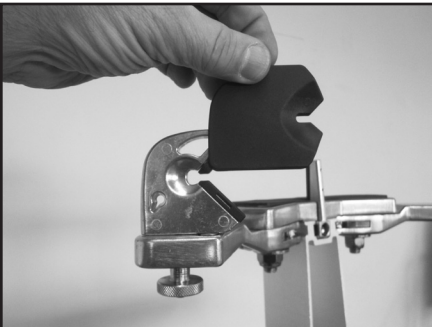

## Badminton Shoulder Support Pad Installation

Slide the badminton shoulder support cover over the shoulder supports. There is no need to remove the tennis shoulder supports.

**Note:** An optional badminton frame support for the head of the racquet is available.

# PATHFINDER AWL

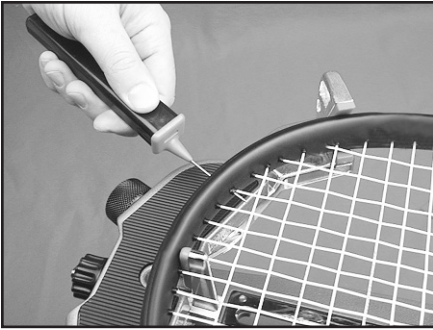

The machine includes the pathfinder stringing awl which creates a pathway between or around strings to make inserting a string through blocked grommets easier and quicker.

Insert the awl through the grommet hole in the same manner as for traditional awls. The Pathfinder awl must be in the closed position before insertion.

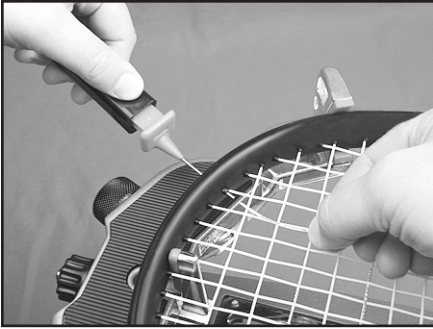

Once the awl is inserted, pull the handle of the awl outward while holding the tip section in place. This leaves the outer sheath in the grommet hole. Insert the end of the string into the outer sheath.

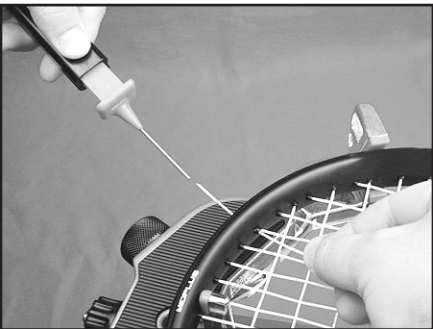

While holding the string, slowly pull the sheath out of the grommet hole to leave the free end of the string exposed.

# MAINTENANCE & ADJUSTMENTS



## Adjusting the Turntable Bushings

The turntable bushing is adjusted at the factory for optimum performance. After time and use, the turntable bushings may need minor adjustment. An adjustment is indicated when noticeable turntable looseness or wobble occurs while stringing.

To adjust the fit between the turntable pin and the bushings, tighten the set screw at the top of the bushing using a 3mm hex wrench.



## Adjusting the Clamp Pressure

The clamps provided with your stringing machine will need minor adjustments according to what string type, construction, and gauge you are using.

To adjust the gap (clamping pressure) between the clamp jaws, insert the string through the racquet as if you were beginning the main strings. Clamp the strings and pull tension. If the string slips through the jaws of the clamp, tighten the clamp by compressing the clamp jaws together by hand while turning the Adjustment Knob, in the clockwise direction. If the clamp leaves impressions or damages the string, it may be excessively tight and should be adjusted by turning the

hex screw counter clockwise to open the gap between the jaws. The clamp jaws should be cleaned periodically to be free from dirt, oil, and any string coating for them to grip properly.

**Note:** The string clamps supplied with your stringing machine can accommodate tight string patterns such as badminton. Depending on the string pattern, the clamp may spread the strings slightly which will not compromise the quality of the string job.

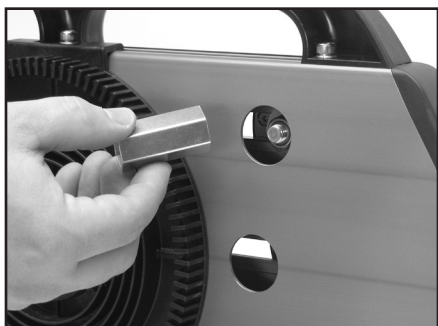

## Clamp Base Locking Nut Adjustment

In the event the Locking Lever rotation is insufficient to ensure smooth operation of the clamp base, very minor adjustments to the Clamp Base Locking Nut can be made with the supplied 17mm socket. Tighten or loosen the locking nut in very small increments to provide more clamping pressure or running clearance as needed.

# TROUBLESHOOTING TIPS

<u>PROBLEM</u>	<u>SOLUTION</u>
String slips in clamps	<ul style="list-style-type: none"><li>- Adjust gap between clamp jaws</li><li>- Clean clamp jaws</li></ul>
String slips in gripper	<ul style="list-style-type: none"><li>- Clean gripper jaws</li><li>- Make sure string is wrapped over top gripper prior to inserting between gripper jaws</li></ul>
String clamp base slips on turntable	<ul style="list-style-type: none"><li>- Clean bottom of clamp &amp; top of turntable with alcohol</li><li>- Adjust clamp base locking nut</li></ul>

## CARE & CLEANING

With time and use, the clamping surfaces of your machine may become oily or dirty and result in string or clamp slippage while stringing. Periodic cleaning of the String Clamps, String Clamp Base and String Gripper is recommended. Knife sharpening stones work well for cleaning the diamond coated string clamping surfaces. Cleaning with a solvent such as isopropyl alcohol and a mild abrasive tool such as a toothbrush also works well to remove oily or greasy build up.

# PARTS LIST

PART #	DESCRIPTION	PART #	DESCRIPTION
4A	TURNTABLE BUSHING	MDCSC13	UNIV DIECAST STRING CLAMP
5	RUBBER FOOT	MQAC11	QUICK ACTION BASE- TALL
6A	CAP SCREW- M8x25	MRSRG	ROTATIONAL GRIPPER
8	BUSHING SET SCREW		
9	WASHER- M8		
10B	WINDER STAND		
14	WASHER- M10		
21A	FRAME SUPPORT SLIDE		
25	TENSION BAR		
26	TENSION BAR CAP		
27	DROP WEIGHT KNOB		
28	FRONT WEIGHT- BADMINTON		
29	BACK WEIGHT		
30	TENSION BAR DRUM		
30A	SET SCREW		
31	STRING GRIPPER DRUM		
34	RATCHET TEETH		
35	RATCHET SPRING		
83	TENSION BAR STOP SCREW		
133	FRAME SUPP SLIDE SCREW		
140	MTNG STAND TOP PLATE		
141	MTNG STAND TOP PAD		
144	SHLDER SUPP LOCK KNOB		
146A	SUPP ARM ADJUST KNOB		
161	WINDER BEARING		
162	GRIPPER PIVOT PIN		
163	PIVOT PIN RETAINING COLLAR		
187	PII BASE		
188	PII BASE COVER		
189	PII LOWER TRAY PAD		
190	PII UPPER TRAY PAD		
261	TT END CAP		
262	SUPP POST MOUNTING PLATE		
267	TT END CAP- RIGHT		
268	TT END CAP- LEFT		
271	SUPPORT POST		
284	3 PIECE TURNTABLE		
356	QM ARM (LONG) RIGHT		
357	QM ARM (LONG) LEFT		
381	SHOULDER V-MOUNT		
			<b>TOOLS &amp; ACCESSORIES</b>
		71	6MM T-AHNDLE HEX WRENCH*
		98	10MM WRENCH*
		108	UTILITY KNIFE*
		109	NEEDLE NOSE PLIERS*
		110	BENT NOSE PLIERS*
		196	17MM SOCKET*
		251	HEX WRENCH SET*
		MA	STRINGER'S AWL*
		MPSA	PATHFINDER AWL*
		MFSP11	FRAME SUPP PADS
			SHORT BADMINTON (SB)
			SQUASH (SQ)
			TENNIS (T)
			BADMINTON (B)
		MMSP13	V-MOUNT SUPP PAD
		MBMSP11	BADM SHOULDER SUPP COVER
			*(NOT SHOWN)
			<b>OPTIONAL TOOLS &amp; ACCESS</b>
		MBFS11	BADM FRAME SUPPORT
		MBMSS11	BADM MOUNTING SYS UPG
		MBFC	BADM FLOATING CLAMP
		MDCSC	BADM FIXED CLAMP
		MPG	STARTING CLAMP
		MPMC	MACHINE COVER
		MPS	CLEANING STONE
		MPXFS	FLOOR STAND
		SGSM	STRINGER'S MAT

# PARTS DRAWING

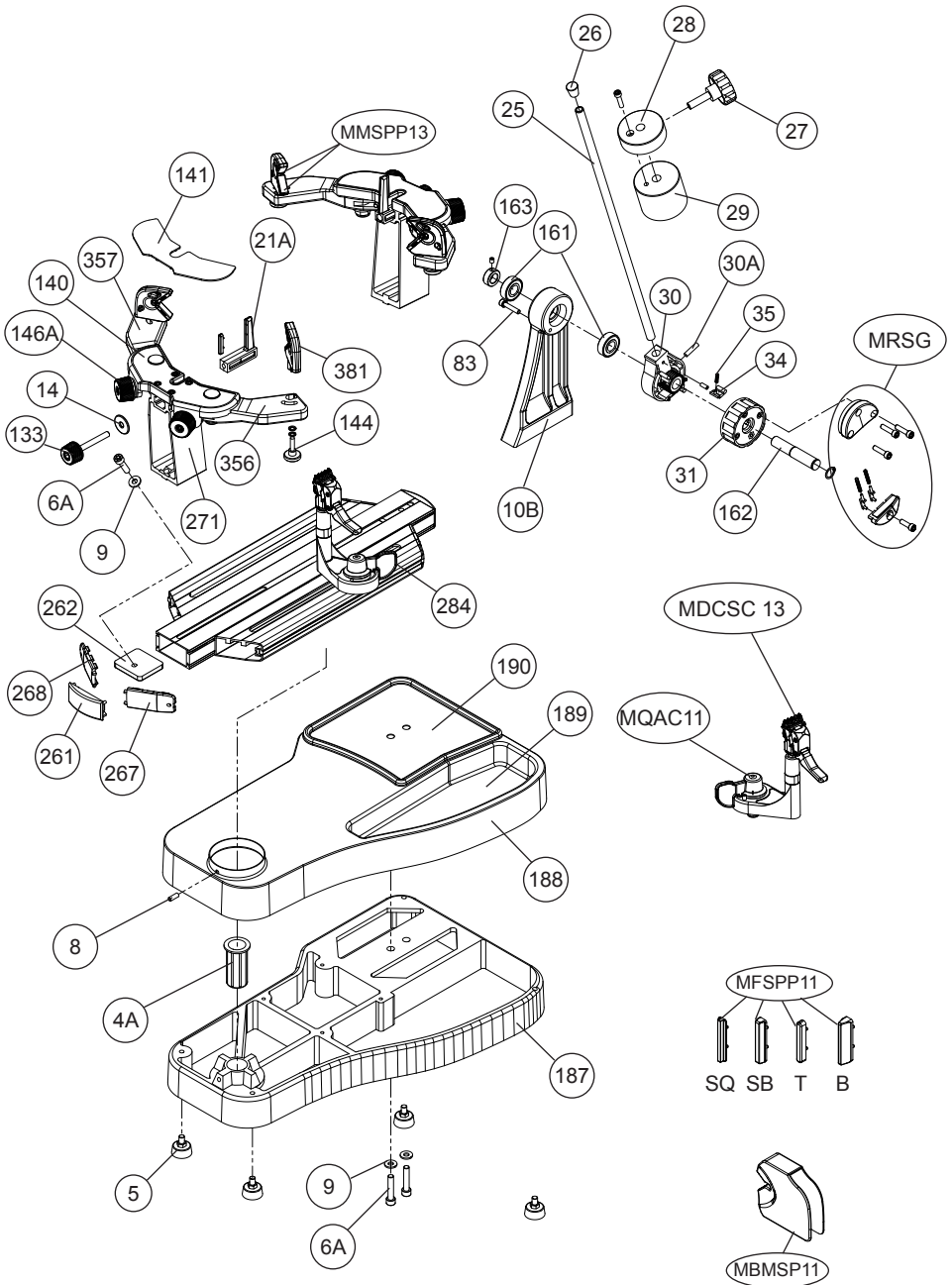



MMAN-44  
(MP62F-13)

**GAMMA SPORTS**

200 Waterfront Drive  
Pittsburgh, Pennsylvania 15222  
Phone : 800.333.0337 Fax : 412.323.0317  
Visit our website at [www.gammasports.com](http://www.gammasports.com)