



 **ENERGAIN**[®]
ILUMINACIÓN SUSTENTABLE

DESCARGA TÚ FICHA TÉCNICA



APUNTA TU CÁMARA
EN EL CÓDIGO QR



ESCANEA EL
CÓDIGO QR



ESPERA QUE CARGUE
LA PÁGINA WEB

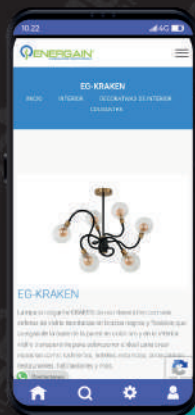

ACCEDE A LA
INFORMACIÓN Y
FICHA TÉCNICA
DEL PRODUCTO

Boque de Chapultepec

20
24

ÍNDICE

LABORATORIO
TEMPERATURA DE COLOR
VENTAJAS DE LOS LEDS

4
8
9

LUMINARIAS PARA OFICINA

21

TIPO PANEL 22
SUSPENDIDAS PDL 24

TIRAS LED

55

TIRAS LED 56
TIRA MESH 57
TIRA COB 50M 59
PERFILES 60

LÁMPARAS LINEALES

76

T5 77
T5C 78
T8 79
T8C 81
T8 CURVALUM 82
GABINETE ENVOLVENTE 82
GABINETES INDUSTRIALES 83

BAÑADORES

96

BAÑADOR DE PARED 99
CORTESÍA EMPOTRABLES 104
ESTACAS 105
SUMERGIBLES 107
UP LIGHTS 108
BAÑADORES EMPOTRABLES 110

DOWNLIGHTS

12

SERIE COB 13
SERIE LEP 16
SERIE LEPC 17
SERIE LEPS 18
SERIE LEPCS 19
EMPOTRABLE BOTE INTEGRAL 20

DECORATIVAS DE INTERIOR

26

ARBOTANTES 27
CORTESÍA 29
COLGANTES 33

LÁMPARAS DE ACENTO

61

PAR 62
AR111 62
MR16 64
SHELL 66
CACAHUATES 69
TRACK LIGHTS 72

BOMBILLAS

86

DOMÉSTICAS 87
BOMBILLA MESH 88
ALTA POTENCIA 89
VINTAGE (FILAMENTOS) 92
CANDELABRO (TIPO VELA) 95

DECORATIVAS DE EXTERIOR

SOBREPONER	112
TIPO BOLARDO	113
ARBOTANTES	114
SOLAR AUTÓNOMO	118

INDUSTRIAL

LINK	135
SERIE BAY	136
SERIE UFO	137
SERIE UFO ECO	138
SERIE QD	140
LÁMPARA DE EMERGENCIA	141

FOTOVOLTAICOS

SISTEMAS FOTOVOLTAICOS	150
AUTÓNOMAS SOLARES	152

ACCESORIOS

BASE G13 PARA T8	159
FUENTES DE PODER	159
ACCESORIOS EMPOTRABLES	161
ACCESORIOS TRACKLIGHT	161
BALASTRO DE EMERGENCIA	163
AMPLIFICADOR	164
CONTROLADORES	164
ACCESORIOS DMX	166
CONTROLADORES BAÑADORES	168
ACCESORIOS TIRA LED	170
ACCESORIOS LUMIARIA VIAL	174
SOPORTE UFO	175
ACCESORIOS PDL	176

REFLECTORES

SERIE FL	121
SERIE FL ECO	125
SERIE MEKA	127
SENSOR	131
SERIE FENIX	131
WALLPACK	133

VIAL

SERIE LHD	143
-----------	-----

LÁMPARAS SUBURBANAS

TURM	154
PUNTA DE POSTE	155

2024 ÍNDICE

ALTURA IDEAL	177
GLOSARIO	178
CONSUMO DE ENERGÍA	179
ÁNGULO DE APERTURA	180
TIPO DE ILUMINACIÓN	181
IP	182
COBERTURA NACIONAL	184



EVERFINE SPEKTRON Coating
Integrating Sphere

LABORATORIO DE PRUEBAS

En ENERGAIN convencidos en la calidad de nuestros productos y procesos, invertimos en un laboratorio de pruebas con tecnología de última generación especializada en pruebas de iluminación para cualquier tipo de luminaria con tecnología LED, con un riguroso control de producción aplicando los más altos estándares y normas dando como resultado una mejora constante en nuestros productos de iluminación, avalando la excelente calidad de los mismos por medio de varios equipos una esfera integradora de Ulbricht, un goniómetro, un área de pruebas IPX3/IPX4 y un generador de sobretensiones.

El laboratorio de pruebas de iluminación cuenta con una **esfera integradora de Ulbricht**, la esfera integradora es un equipo esférico fabricado en acero en frío de dos metros de diámetro que tiene en su interior un recubrimiento de reflectancia difusa, que parece casi lambertiano (superficie ideal que refleja la energía incidente desde una dirección igual en todas direcciones, por lo cual al variar el punto de vista, su luminancia no cambia.), el recubrimiento tiene una alta reflectancia mayor al 80%, la cual al insertar una fuente de luz permite medir el flujo luminoso y las prestaciones de color. Además, cuenta con dos configuraciones de medición de las luminarias: Configuración 2π (la fuente de luz que se va a medir se monta en una abertura de la pared de la esfera) y Configuración 4π (la fuente de luz bajo prueba se instala en el centro de la esfera integradora).

En México existen muy pocas empresas que cuenten con laboratorios de pruebas de iluminación que posean una esfera con estas dimensiones y capacidad, la esfera tiene la habilidad de medir luminarios y lámparas de LEDs, incandescentes y fluorescentes.

ESFERA
INTEGRADORA
DE ULBRICHT

GONIOFOTÓMETRO GO-2000



相对于转动中心特别不平衡的灯具，请正确配重后再进行测试，否则会影响仪器！

Lamps with unbalanced fixture relative to the rotating center may affect the balance counterweight properly before test, or it will damage the instrument.

Nuestra esfera integradora, nos permite medir las características de los luminarios y lámparas bajo prueba como: Flujo luminoso (lm), potencia radiante(W), eficiencia (lm/W), Distribución de potencia espectral $P(\lambda)$, Coordenadas de cromaticidad (Duv), Temperatura de color correlacionada (CCT), Índice de reproducción cromática (CRI o Ra), SDCM, Longitud de onda dominante etc. El gabinete de equipos con los que cuenta la esfera integradora dispone de medidores eléctricos que miden parámetros eléctricos como la potencia, tensión, corriente, factor de potencia, distorsión armónica tanto en tensión como en corriente en el orden de 49 armónicas como lo marcan las normas oficiales mexicanas (NOM), además cuenta con software especializado para generar reportes de los estudios de las luminarias que se ponen a prueba.

GO-2000 es un Goniófotómetro con facilidad para girar la fuente de luz en dos configuraciones según el sistema de coordenadas B- β y C- γ (gamma) avalados por el CIE, la fuente de luz y el fotómetro se encuentran instalados horizontalmente en configuración emisor-receptor. El goniófotómetro debe contar con un cuarto oscuro para que el flujo luminoso que detecte el sensor sea lo más preciso posible, por el principio científico de la refracción que explica que el color negro absorbe todo tipo de luz.

Este equipo ayuda a calcular varias características eléctricas como fotométricas esencialmente: el ángulo de apertura, flujo luminoso, eficacia luminosa, proyección de iluminación etcétera. Además, es capaz de generar el archivo fotométrico IES el cual sirve para realizar cálculos de iluminación arquitectónica mediante software especializado para la simulación de iluminación, por ejemplo DIALux. El gabinete de equipos con los que cuenta el Goniófotómetro también dispone de medidores eléctricos como la esfera integradora de Ulbricht, que miden parámetros eléctricos como la potencia, tensión, corriente, factor de potencia, distorsión armónica tanto en tensión como en corriente en el orden de 49 armónicas como lo marcan las normas oficiales mexicanas (NOM), además cuenta con software especializado para generar reportes de los estudios de las luminarias pero dependiendo de las características de cada luminaria.

PRUEBAS DE IPX3/4

Aquí se realizan pruebas de protección contra ingreso de agua en dos niveles diferentes como lo son IPX3 (Protección contra rocío de agua) en dicha prueba se coloca el luminario en el centro de la máquina sobre una base giratoria y un aspersor con forma de medio círculo gira 120 grados y rocía con agua al luminario durante 20 minutos y en este lapso de tiempo el luminario no debe presentar filtraciones de agua en su interior, si la luminaria supera la prueba nos cercioramos que el producto cumple con los estándares IP, en el caso de la prueba IPX4 (Protección contra salpicaduras de agua) es similar solo que el aspersor gira 350 grados, lo que implica un rango más amplio para rociar con agua al luminario.





GENERADOR SOBRETENSIONES

Un equipo que puede generar un tren de pulsos de sobretensión desde 250 volts en corriente alterna hasta 7,000 volts con un periodo de duración corto por lo general en milisegundos, todo esto con el objetivo de simular picos en la alimentación en donde se puedan llegar a generar estos picos y así asegurar la vida útil y la funcionalidad de las luminarias ante las sobretensiones de línea, generalmente esta prueba se emplea principalmente para luminarias de calle que pueden ser susceptibles tanto a descargas eléctricas de línea eléctrica y descargas eléctricas de origen atmosférico, también se aplica para los luminarios de altas potencias que se conectan a las líneas eléctricas industriales donde las descargas eléctricas están en el rango de tensión eléctrica de 220 a 277 volts de corriente alterna, pero en general esta prueba aplica para todos los luminarios según sus diferentes especificaciones, como lo mencionan las normas vigentes de iluminación LED.

TEMPERATURAS DE COLOR



Blanco Frío
6000 K

Ambiente

- Dinámico
- Claro
- Energético

Aplicación:

- Fast food
- Grandes áreas
- Pasillos de Hospitales

Blanco
5000 K

Ambiente

- Eficiente
- Jovial
- Activo

Aplicación:

- Escuelas
- Despachos
- Oficinas

Blanco Neutro
4100 K

Ambiente

- Dinámico
- Claro
- Energético

Aplicación:

- Joyería
- Aparadores
- Vialidades
- Áreas de producción

Blanco Cálido
3000 K

Ambiente

- Amigable
- Relajado
- Personal

Aplicación:

- Hoteles
- Restaurantes
- Cafés

VENTAJAS DE LOS LEDS

Datos obtenidos del manual de Iluminación Vial emitido por la Secretaría de Comunicaciones y Transportes.

Eficiencia Luminosa

01

Unas de las características fundamentales de los LEDs es su **bajo consumo y su alta eficiencia** porque una gran parte de la energía que consumen es transformada en luz. Esto implica un ahorro económico de energía eléctrica. **Supera en eficiencia** a las lámparas fluorescentes, los "focos ahorradores" o a la lámpara de vapor de sodio.

Mayor Resistencia a golpes y vibración

02

El chip del LED se recubre en un encapsulado de resina, el cual es **resistente a caídas y golpes**. Si un LED se cae no se rompe como una lámpara incandescente, un tubo fluorescente, una lámpara de vapor de sodio o neón.

Mayor vida útil

03

El LED tiene una **vida útil de entre 25,000 y 100,000 horas de uso**. Esto contrasta en gran medida con las 1,000 -15,000 horas que proporciona una lámpara incandescente o una **lámpara fluorescente, quedando por debajo** de las prestaciones que nos ofrece la tecnología LED.

Menor Mantenimiento

04

Su **larga vida útil** permite asegurar que durante la vida del producto, el componente operará regularmente. **Con los cuidados básicos** el producto LED no requiere mantenimiento durante su periodo de vida útil (en promedio 40,000 hrs.).

Facilidad de Control

05

El LED es un **elemento tan versátil** que nos permite generar pantallas de visualización, tiras flexibles de LED, módulos, etc. Debido a su principio de 3 diodos es posible **crear cambios de color, atenuar, hacer programación**, etc. Todo a través de sencillos controles.



DOWNLIGHT
DOWNLIGHT
DOWNLIGHT
DOWNLIGHT
DOWNLIGHT
DOWNLIGHT
DOWNLIGHT
DOWNLIGHT
DOWNLIGHT
DOWNLIGHT
DOWNLIGHT
DOWNLIGHT
DOWNLIGHT
DOWNLIGHT



EG-SDCOB-3W

3W



6,000 K
3,000 K

100-240V~
35,000 h
45°

IP40
210 lm
106 g

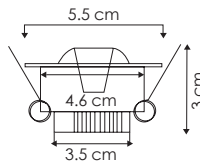

EMPOTRABLES SERIE COB

EG-SDCOB-9W



9W

- 6,000 K
- 3,000 K

- 100-240V~
- 35,000 h
- 45°

- IP40
- 650 lm
- 270 g

180°

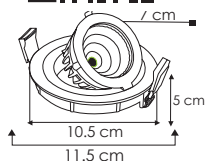

EG-MSCOB-3W

3W

- 6,000 K
- 2,700 K

- 100-240V~
- 35,000 h
- 45°

- IP40
- 200 lm
- 53 g

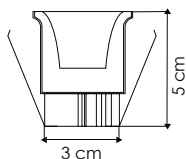

EG-COB-10W-MESH



10W

6,000 K + 3,000 K

100-240V~

35,000 h

60°

IP40

APP MESH LAMP



650 lm

IRC 80

318 g

Bluetooth 4.0

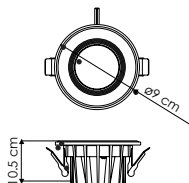

- CAMBIO DE TEMPERATURA DE COLOR.
- ATENUABLE CON LA APP.

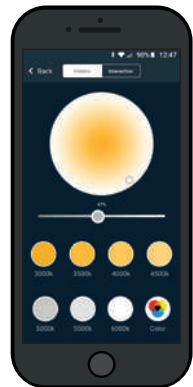

EMPOTRABLES SERIE LEP

EG-LEP



- 6,000 K
- 4,100 K
- 3,000 K

 atenuable
(Añadiendo EG-DPPA)

 Disponible con balastro de emergencia (Añadiendo EG-BE40W)



3W

6W

9W

12W

18W

24W*

 100-240V~	100-240V~	100-240V~	100-240V~	100-240V~	100-240V~
 35,000 h	35,000 h	35,000 h	35,000 h	35,000 h	35,000 h
 120°	120°	120°	120°	120°	120°
 IP50	IP50	IP50	IP50	IP50	IP50
 145 lm	360 lm	580 lm	780 lm	1,250 lm	1,600 lm
 90 g	140 g	200 g	240 g	400 g	720 g
 Ø8.5cm	Ø12cm	Ø14.6cm	Ø17cm	Ø22.5cm	Ø30cm
 Ø7.4cm	Ø10.8	Ø13cm	Ø15.8cm	Ø20.6cm	Ø28.2cm



*Disponible solo en TCC 6 000K y 3 000K y no disponible en versión atenuable

EMPOTRABLES SERIE LEPC

EG-LEPC



6,000 K
3,000 K

atenuable
(Añadiendo EG-DPPA)



Disponibile con balastro
de emergencia
(Añadiendo EG-BE40W)

6W

9W

12W

18W

100-240V~
35,000 h
120°
IP50

100-240V~
35,000 h
120°
IP50

100-240V~
35,000 h
120°
IP50

100-240V~
35,000 h
120°
IP50

540 lm
160 g
12.1*12.1cm
9.6*9.6cm

810 lm
200 g
15*15cm
12.5*12.5cm

1,080 lm
240 g
17.4*17.4cm
14.5*14.5cm

1,620 lm
480 g
22.6*22.6cm
19.5*19.5cm



SOBREPONER SERIE LEPS

EG-LEPS



 atenuable (Añadiendo EG-DPPA)

 Disponible con balastro de emergencia (Añadiendo EG-BE40W)

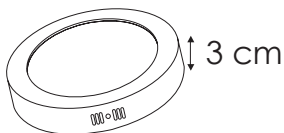









6W

12W

18W

24W*

	6,000 K 3,000 K	6,000 K 3,000 K	6,000 K 3,000 K	6,000 K
	100-240V~	100-240V~	100-240V~	100-240V~
	35,000 h	35,000 h	35,000 h	35,000 h
	120°	120°	120°	120°
	IP50	IP50	IP50	IP50
	360 lm	840 lm	1,350 lm	1,700 lm
	200 g	360 g	480 g	700 g
	Ø12cm	Ø17cm	Ø22.5cm	Ø30cm



*Disponible solo en TCC 6,000K no disponible en versión atenuable.

EG-LEPCS



 atenuable (Añadiendo EG-DPPA)

 Disponible con balastro de emergencia (Añadiendo EG-BE40W)

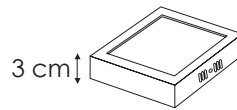

6W

12W

18W

24W*

 6,000 K
 3,000 K

6,000 K
3,000 K

6,000 K
3,000 K

6,000 K

 100-240V~

100-240V~

100-240V~

100-240V~

 35,000 h

35,000 h

35,000 h

35,000 h

 120°

120°

120°

120°

 IP50

IP50

IP50

IP50

 360 lm

840 lm

1,350 lm

1,700 lm

 240 g

380 g

600 g

700 g

 12*12cm

17.5*17.5cm

22.5*22.5cm

30*30cm



*Disponible solo en TCC 6,000K y no disponible en versión atenuable.

EMPOTRABLES PARA BOTE INTEGRAL







EG-IBO-12W



*Diseñada
para bote
integral 4"



12W

- | | | |
|---|---|--|
|  6,000 K |  100-265V~ |  IP20 |
|  3,000 K |  25,000 h |  900 lm |
| |  120° |  Ø14.6*H3.3cm |



OFICINA

OFICINA

OFICINA

OFICINA

OFICINA

OFICINA

OFICINA



OFICINA

LUMINARIAS TIPO PANEL

Marco de aluminio color blanco.



EG-60X60LP-36W

36W

6,000 K
atenuable
(Añadiendo EG-DPPA)

100-240V~
35,000 h
105°

IP50
3,240 lm

3.94kg
60*60cm

Disponible con balastro de emergencia
(Añadiendo EG-BE40W)



EG-60X60LP-40W

40W

6,000 K
4,100 K
atenuable
(Añadiendo EG-DPPA)

100-240V~
35,000 h
105°

IP50
3,200 lm

3.94kg
60*60cm

Disponible con balastro de emergencia
(Añadiendo EG-BE40W)



No incluye Kit de suspensión EG-CP-CPL

*Driver para atenuar EG-DPPA se vende por separado

LUMINARIAS TIPO PANEL











Marco de aluminio color blanco.



EG-30X120LP-40W









40W

- 6,000 K
- 4,100 K
-  atenuable (Añadiendo EG-DPPA)
-  100-240V~
-  35,000 h
-  105°
-  IP50
-  3,200 lm
-  3.28kg
-  30*120cm
-  Disponible con balastro de emergencia (Añadiendo EG-BE40W)



EG-60X120LP-72W

72W

- 6,000 K
- 4,100 K
-  atenuable (Añadiendo EG-DPPA)
-  100-240V~
-  35,000 h
-  105°
-  IP50
-  6,500 lm
-  7.14kg
-  60*120cm
-  Disponible con balastro de emergencia (Añadiendo EG-BE40W)



No incluye Kit de suspensión EG-CP-CPL
 *Driver para atenuar EG-DPPA se vende por separado

OFICINA

EG-BPP60X60



Bases blancas para sobreponer los paneles EG-30X120LP-38W, EG-30X120LP-40W y EG-60X60LP-36W, EG-60X60LP-40W RESPECTIVAMENTE.
EG-BPP60X120-72W sobre pedido.

EG-BPP30X120

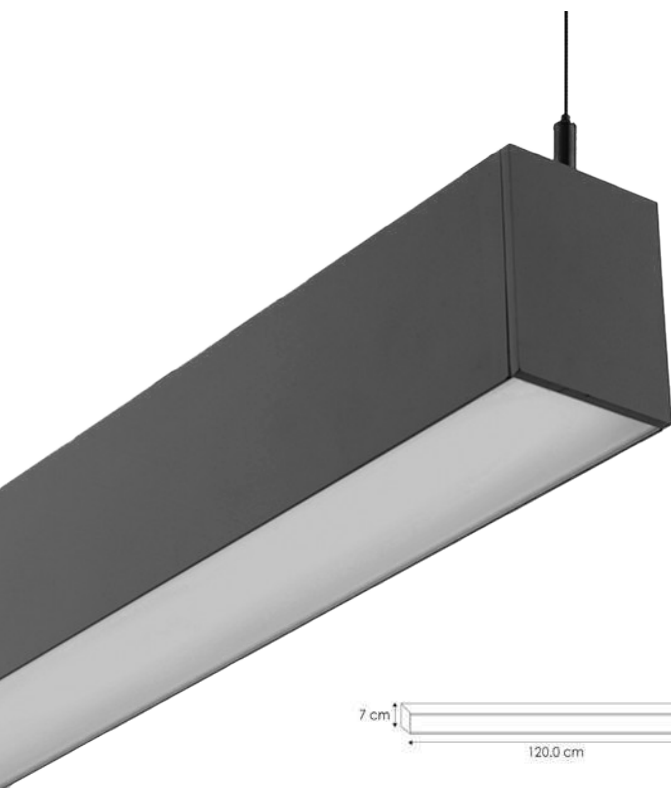

EG-PDL-4000

40W

- 4,000 K
- atenuable*
- 100-277V~
- 35,000 h
- 120°
- IP50
- 4,800 lm
- 3.200kg
- Incluye kit de suspensión



Accesorios se venden por separado. Se necesita cable Atenuador a 0-10V.
Para crear líneas de luz utiliza: EG-PDL-CONX, EG-PDL-CON-L, EG-PD-L-CON-T.



EG-PDL19LS

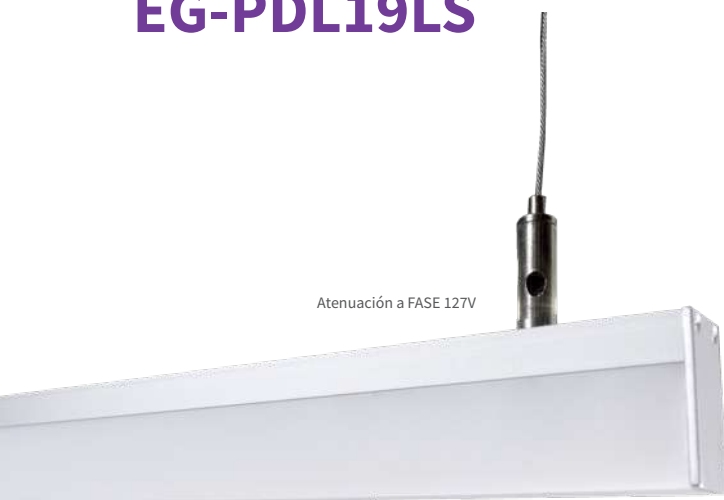

Atenuación a FASE 127V

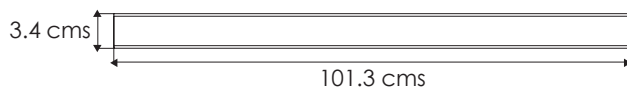

15W

4,100 K
atenuable

127V~
35,000 h
220°

IP50
1,500 lm
180 g
3.4*101.3cm
Incluye kit de suspensión



EG-AUREA

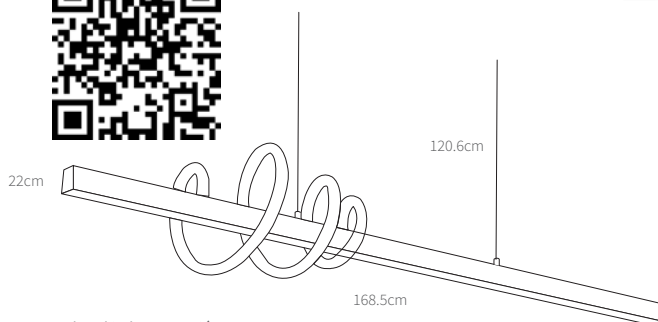

Incluye kit de suspensión

42W

3,000 K
100-277V~
35,000 h
120°

IP20
2,862 lm

DECORATIVAS
DE INTERIOR
DECORATIVAS
DE INTERIOR
DECORATIVAS
DE INTERIOR
DECORATIVAS
DE INTERIOR
DECORATIVAS
DE INTERIOR
DECORATIVAS
DE INTERIOR
DECORATIVAS
DE INTERIOR



DECORATIVAS
ARBOTANTES INTERIOR

EG-ARCSLIM-12W

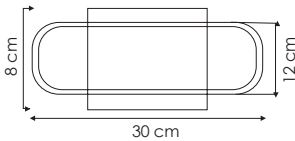

12W

3,000 K

IP50
960 lm
400 g

100-240V~

35,000 h

bidireccional

EG-ARGRAN-18W

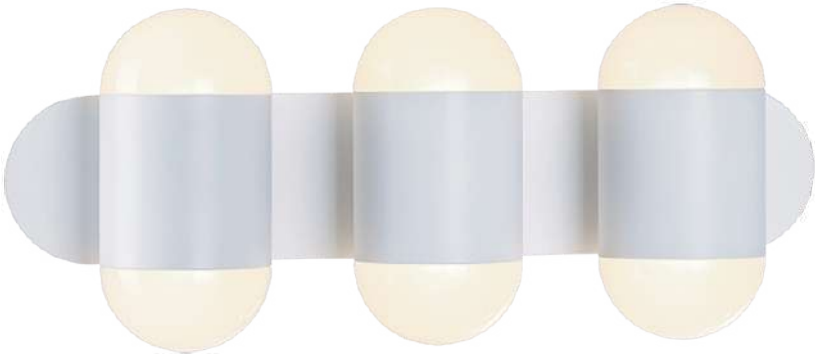

18W

3,000 K
100-240V~
35,000 h
bidireccional

IP50
1,440 lm
800 g

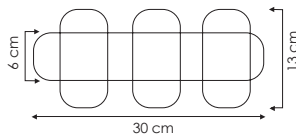

DECORATIVAS ARBOTANTES INTERIOR

EG-BIGBEN



3W

■ 4,000 K

⚡ 100-240V~

🕒 35,000 h

▲ 30°

💧 IP50

💡 300 lm

⚖️ 300 g



EG-LCP-5W



5W

■ 3,000 K

⚡ 100-240V~

🕒 35,000 h

▲ 30°

💧 IP20

💡 400 lm

⚖️ 580 g



DECORATIVAS CORTESIA INTERIOR

EG-LICU-3W

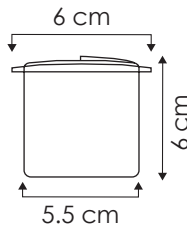

3W

■ 3,000 K

⚡ 100-240V~

⌚ 35,000 h

▲ 90°

💧 IP50

💡 180 lm

⚖️ 145 g



EG-LIRE-3W

3W

■ 3,000 K

⚡ 100-240V~

⌚ 35,000 h

▲ 90°

💧 IP50

💡 150 lm

⚖️ 150 g

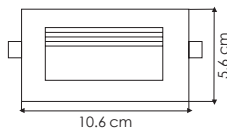
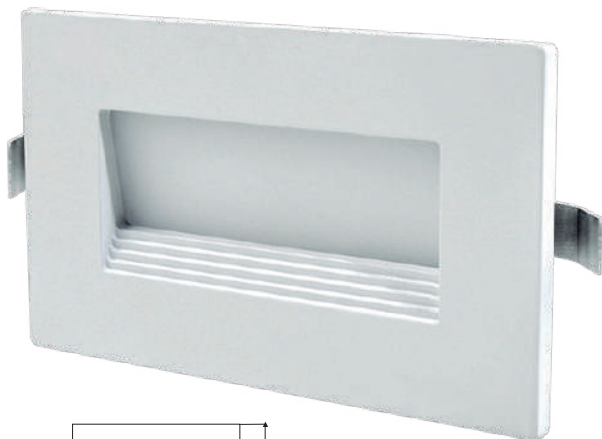

ARBOTANTES INTERIOR

EG-CLASTRA

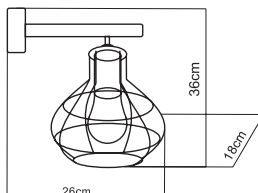

Cuerpo
Metal y
Madera
Incluye bombilla
EG-BF6WV

6W

2,200 K

127 V CA

35,000 h

360°

IP20

740 lm

700g

E26/27



EG-BAYUDA

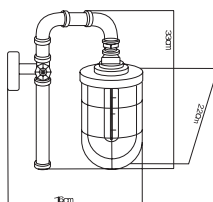

Cuerpo
Metal
Incluye bombilla
EG-BF6WV

6W

2,200 K

127 V CA

35,000 h

360°

IP20

740 lm

700 g

E26/27



ARBOTANTES INTERIOR

EG-SEVILLA

6W

■ 2,200 K

⚡ 127 V CA

⌚ 35,000 h

▲ 360°

💧 IP20

💡 740 lm

⚖ 350 g

🔌 E26/27

Cuerpo

Metal y

Madera

Incluye bombilla

EG-BF6WV



EG-CRACOVIA

4W

■ 2,700 K

⚡ 127 V CA

⌚ 35,000 h

▲ 360°

💧 IP20

💡 450 lm

⚖ 330 g

🔌 E26/27

Cuerpo

Metal

Incluye bombilla

EG-BF4W



ARBOTANTES INTERIOR

EG-VIENA



4W

2,700 K

127 V CA

35,000 h

360°

IP20

450 lm

510 g



Cuerpo

Metal y
tela

Incluye base y
bombilla EG-BF4W

EG-GHERY



Cuerpo

Metal y
Cemento

Incluye cacahuete
EG-C104-5W

5W

3,000 K

127 V CA

35,000 h

90°

IP20

500 lm

1.5 kg

G9

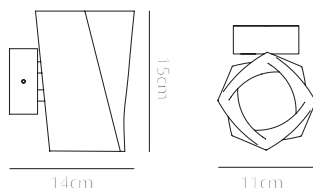

DECORATIVAS COLGANTES



Incluye bombilla
EG-BF6WW



Incluye foco dicróico
EG-S7W

EG-SKYBLACK

6W

- 2,200 K
- ⚡ 127V~
- ⌚ 35,000 h
- ▲ asimétrico
- 💧 IP20
- 💡 740 lm
- ⚖ g
- 📏 E26/27



EG-LEO

7W

- 2,700 K
- ⚡ 127V~
- ⌚ 35,000 h
- ▲
- 💧 IP20
- 💡 600 lm
- ⚖ g
- 📏 GU 10



DECORATIVAS COLGANTES

EG-VIANKA

6W

- 2,200 K
- 127V~
- 35,000 h
- asimétrico

- IP20
- 740 lm
- kg
- E26/27

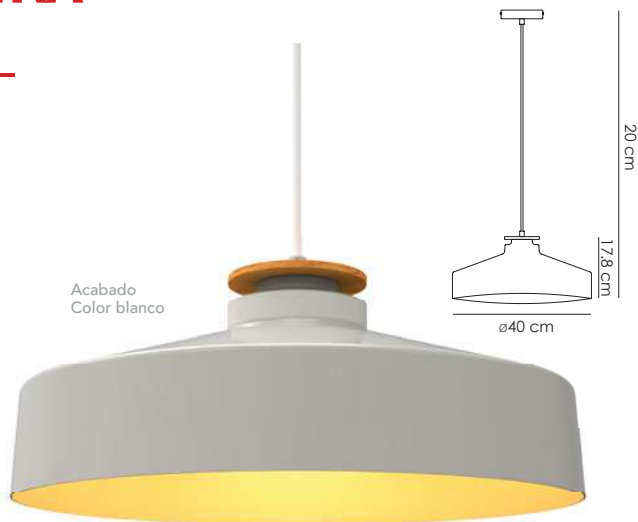

Acabado
Color blanco

Incluye fbombilla
EG-BF6WV

EG-ZURICH

12W

- 2,700 K
- 127 V CA
- 35,000 h
- 360°
- IP20
- 1,200 lm
- 4.51 kg
- E26/27

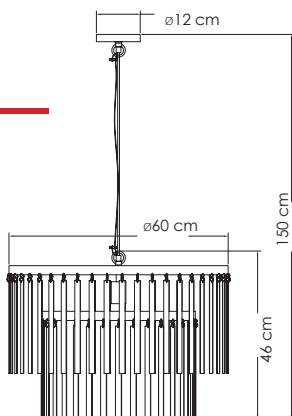

Cuerpo
Aluminio

Incluye bombilla
EG-BF12W



EG-SEUL

12W

■ 2,700 K

⚡ 127 V CA

⌚ 35,000 h

▲ 360°

💧 IP20

☀️ 1,200 lm

⚖️ 1.43 kg

🔌 E26/27

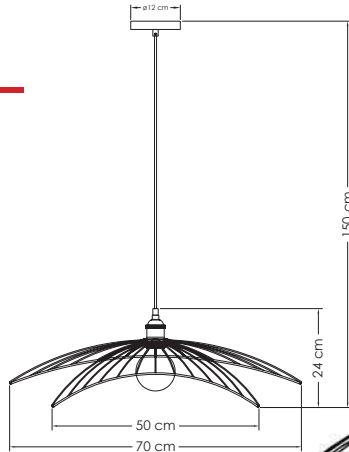

Cuerpo

Metal y
Madera

Incluye bombilla
EG-BF12W



EG-PRAGA

18W

■ 3,000 K

⚡ 127 V CA

⌚ 35,000 h

▲ 360°

💧 IP20

☀️ 1,980 lm

⚖️ 2.53 kg

🔌 G9

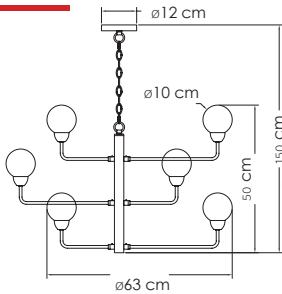

Cuerpo

Metal y
Cristal

Incluye cacahuates
EG-C64-3W



DECORATIVAS COLGANTES

EG-SEVILLA2

20W

■ 2,700 K

⚡ 127 V CA

⌚ 35,000 h

▲ 360°

💧 IP20

☀ 2,250 lm

⚖ 1.46 kg

🔌 E26/27

Cuerpo

Metal y

Madera

Incluye bombilla

EG-BF4W

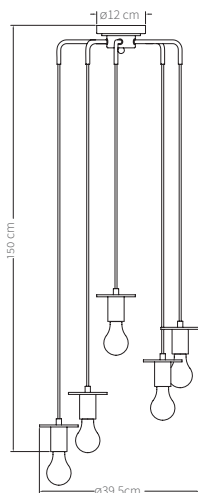

EG-LISBOA

32W

■ 2,700 K

⚡ 127 V CA

⌚ 35,000 h

▲ 360°

💧 IP20

☀ 3,600 lm

⚖ 2.64 kg

🔌 E26/27

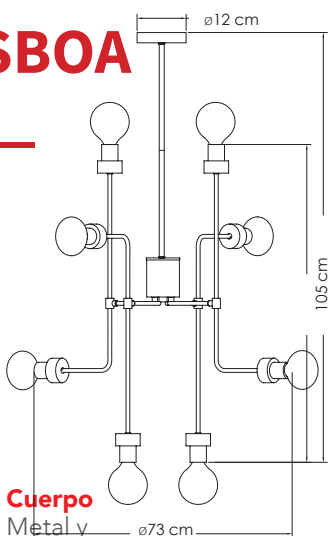

Cuerpo

Metal y

Madera

Incluye bombilla

EG-BF4W



DECORATIVAS COLGANTES

EG-PURRA

6W

2,200 K

127 V CA

35,000 h

360°

IP20

740 lm

1.5 kg

E26/27



Cuerpo
Metal

Incluye bombilla
EG-BF6WV

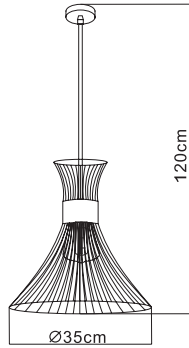

EG-CRACOVIA2

20W

2,700 K

127 V CA

35,000 h

360°

IP20

2,250 lm

1.24 kg

E26/27



Cuerpo

Metal y

Madera

Incluye bombilla

EG-BF4W

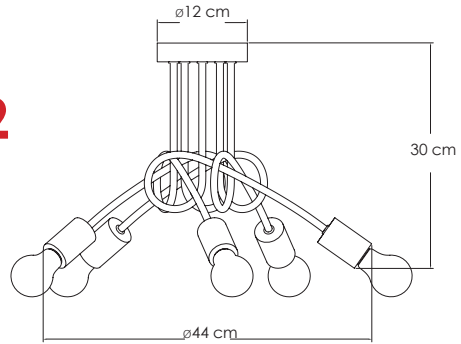

DECORATIVAS COLGANTES

EG-VIENA2

24W

2,700 K

127 V CA

35,000 h

360°

IP20

2,700 lm

4.48 kg

E26/27



Cuerpo

Metal y
Tela

Incluye bombilla
EG-BF4W

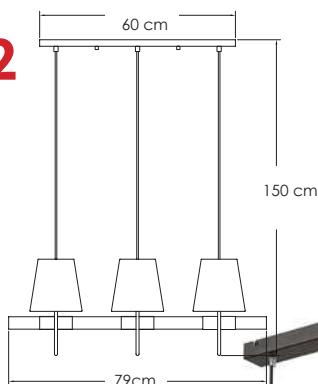

EG-BALI

6W

2,200 K

127 V CA

35,000 h

360°

IP20

740 lm

770 g

E26/27

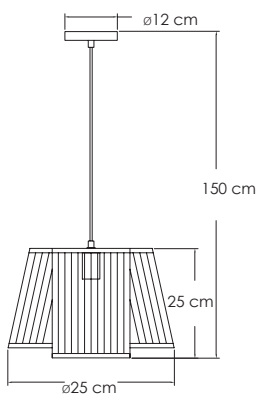

Cuerpo

Madera

Incluye bombilla
EG-BF6WV



EG-BANGKOK

12W

2,700 K

127 V CA

35,000 h

360°

IP20

1,200 lm

670 g

E26/27



Cuerpo

Metal y

Tejido Ratan

Incluye bombilla

EG-BF12W

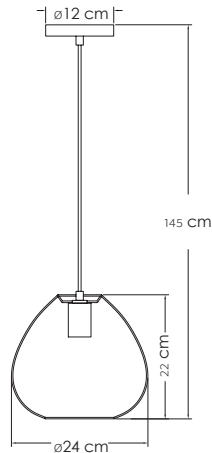

EG-BANGKOK2

12W

2,700 K

127 V CA

35,000 h

360°

IP20

1,200 lm

1.24 kg

E26/27



Cuerpo

Metal y

Tejido Ratan

Incluye bombilla

EG-BF12W

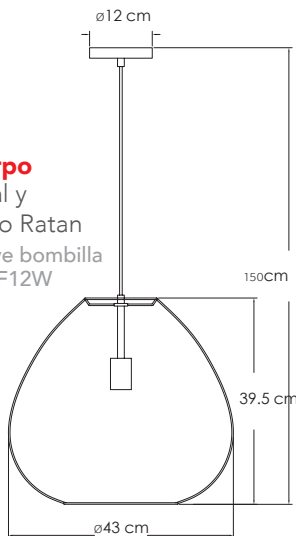

DECORATIVA
COLGANTES

EG-TAILANDIA



48W

2,700 K

127 V CA

35,000 h

360°

IP20

5,920 lm

2.91 kg

Cuerpo

Acero

Incluye bombilla

EG-BF6WV

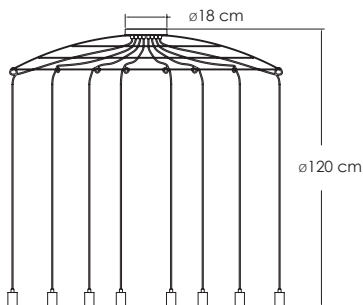
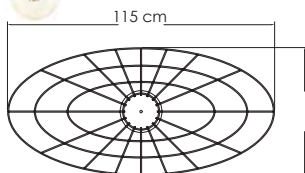

EG-SEMICIR-18W EG-CONE-7W



18W

- 3,000 K
- 100-240V~
- 35,000 h
- asimétrico
- IP50
- 1,440 lm
- 850 g

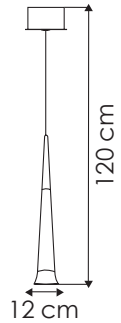

7W

- 3,000 K
- 100-240V~
- 35,000 h
- asimétrico
- IP50
- 560 lm
- 700 g



DECORATIVAS COLGANTES

EG-KRAKEN



■ 3,000 K

⚡ 100-240V~

⌚ 35,000 h

▲ asimétrico

💧 IP50

💡 3000 lm

⚖️ 2.4 kg

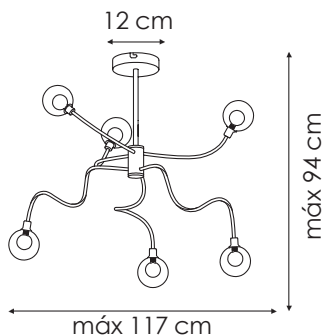

DECORATIVAS COLGANTES

EG-JARRAS-I

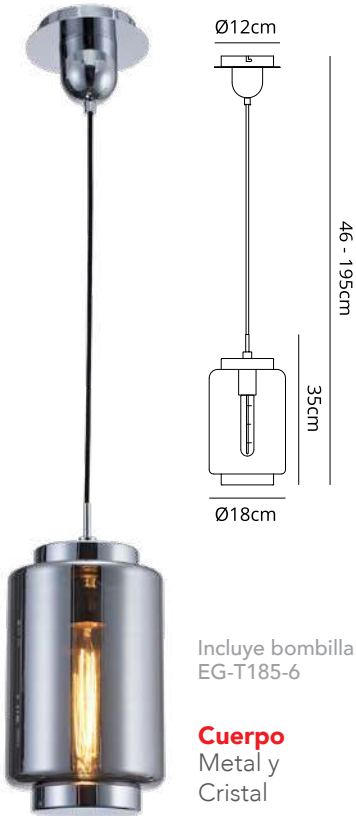

6W

- 2,200 K
- atenuable
- 127 V CA
- 35,000 h
- 360°
- IP20
- 740 lm
- 1.9 kg
- E26/27



EG-JARRAS-II

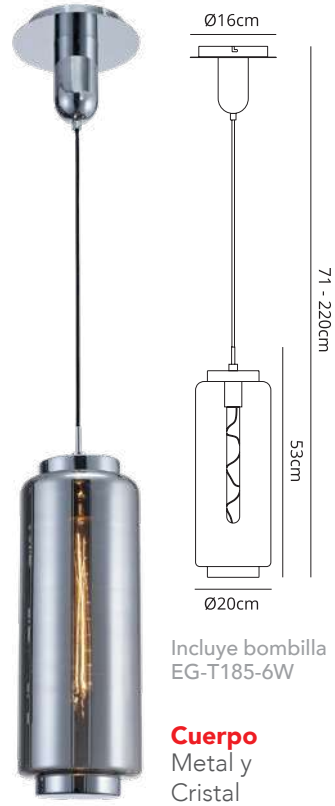

6W

- 2,200 K
- atenuable
- 127 V CA
- 35,000 h
- 360°
- IP20
- 740 lm
- 2.6 k.g
- E26/27



DECORATIVAS COLGANTES

EG-JARRAS-III



Cuerpo
Metal y
Cristal

Incluye bombilla
EG-BFS6W-V

6W

- 2,200 K
- atenuable
- 127 V CA
- 35,000 h
- 360°
- IP20
- 740 lm
- 3.55 kg
- E26/27



EG-RILEY



Cuerpo
Metal y
Cristal

Incluye bombilla
EG-BFS6W-V

6W

- 2,200 K
- atenuable
- 127 V CA
- 35,000 h
- 360°
- IP20
- 740 lm
- 4.1 kg
- E26/27



DECORATIVAS COLGANTES

EG-ASIA

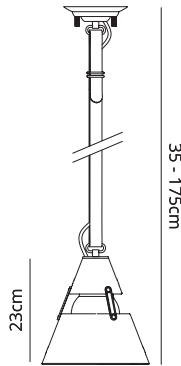

Incluye bombilla
EG-BFS6W-V

Cuerpo
Metal y
Algodón

6W

- 2,200 K
- ⚡ 127 V CA
- 🕒 35,000 h
- ▲ asimétrico atenuable
- 💧 IP20
- 💡 740 lm
- ⚖️ 2.8 kg
- 🔌 E26/27



EG-REYNA

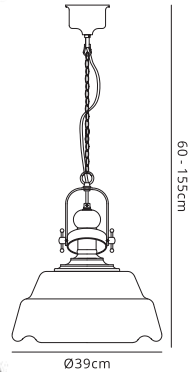
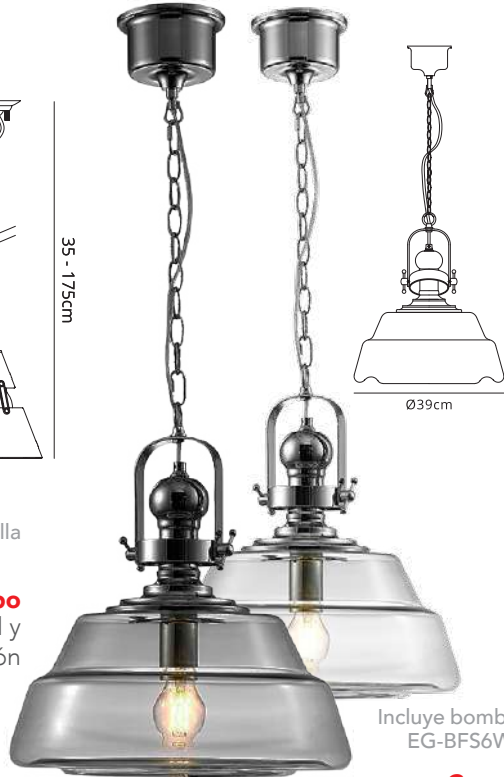

Incluye bombilla
EG-BFS6W-V

Cuerpo
Metal y
Cristal

Disponible en 2 tonos:
ahumado y plata

6W

- 2,200 K
- ⚡ 127 V CA
- 🕒 35,000 h
- ▲ 360° atenuable
- 💧 IP20
- 💡 740 lm
- ⚖️ 3.4 kg
- 🔌 E26/27



DECORATIVAS COLGANTES

EG-MARKUS

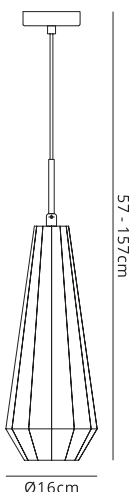

Cuerpo

Metal y
Cristal

Incluye bombilla
EG-T185-6V

6W

- 2,200 K
- 127 V CA
- 35,000 h
- 360°
atenuable
- IP20
- 740 lm
- 1.4 kg
- E26/27



EG-MIRANDA

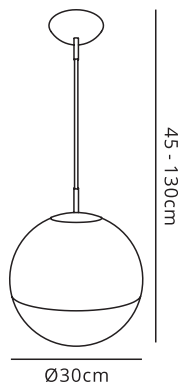
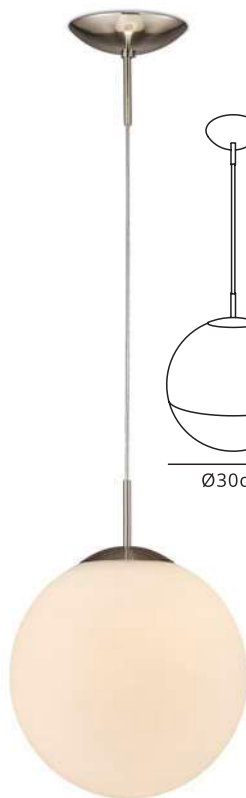

Cuerpo

Metal y
Cristal

Incluye bombilla
EG-B9W-ECO-BC

9W

- 3,000 K
- 127 V CA
- 35,000 h
- 220°
- IP20
- 1080 lm
- 1.6 kg
- E26/27



DECORATIVAS COLGANTES

EG-ATOMIC



Cuerpo
Metal, Cristal
y Plástico

Incluye bombilla
EG-BFS6WV

6W

- 2,200 K
- ⚡ 127 V CA
- ⌚ 35,000 h
- ▲ 220°
atenuable
- 💧 IP20
- ☀️ 740 lm
- ⚖️ 1.7 kg
- 🔌 E26/27



EG-MUCHA



Cuerpo
Metal y
Madera

Incluye bombillas
EG-BFS6W-V

36W

- 2,200 K
- ⚡ 127 V CA
- ⌚ 35,000 h
- ▲ 360°
atenuable
- 💧 IP20
- ☀️ 4,400 lm
- ⚖️ 3.4 kg
- 🔌 E26/27



DECORATIVAS COLGANTES

EG-ISLA

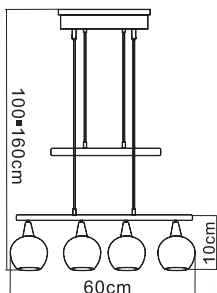
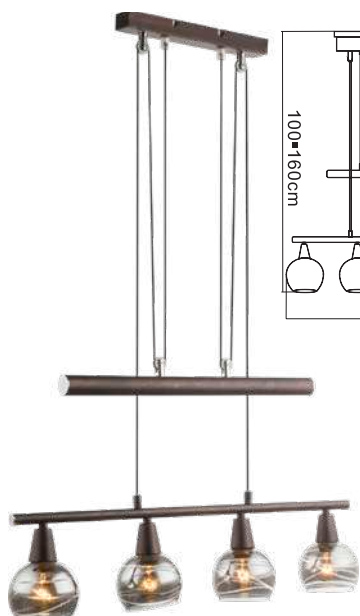

Cuerpo
Metal y
Cristal

Incluye bombillas
tipo vela
EG-BCF4W

EG-TIKO

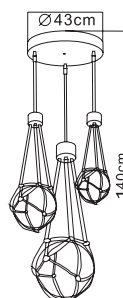

Cuerpo
Metal y
Cristal

Incluye bombillas
EG-BF6WW

16W

2,700 K

127 V CA

35,000 h

220°

IP20

1,760 lm

2.4 kg

E26/27



18W

2,200 K

atenuable

127 V CA

35,000 h

360°

IP20

2,220 lm

4.05 kg

E26/27



DECORATIVAS COLGANTES

EG-MAHA-4

Cuerpo
Metal

Incluye bombillas
EG-BF6W-V



24W

- 2,200 K
- 127 V AC
- 35,000 h
- 360°
- E26/27

IP20
2,800 lm
1.06 kg

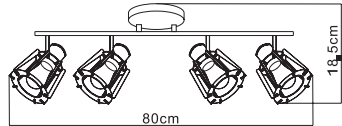

EG-MELLA

Cuerpo
Metal y
Madera



20W

- 3,000 K
- 127 V AC
- 35,000 h
- 120°

IP20
1,300 lm
3.23 kg

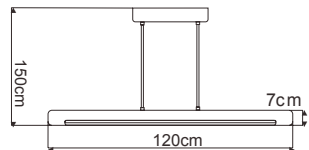

DECORATIVAS COLGANTES

EG-WAVES-72W



72W

- 3,000 K
- 100-240V~
- 35,000 h
- asimétrico
- IP50
- 5,760 lm
- 2.9 Kg

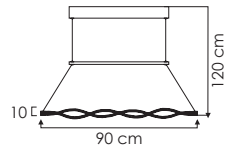

EG-OLIMPO-72W

72W

- 3,000 K
- 100-240V~
- 35,000 h
- asimétrico
- IP50
- 5,760 lm
- 1.6 Kg

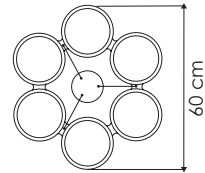
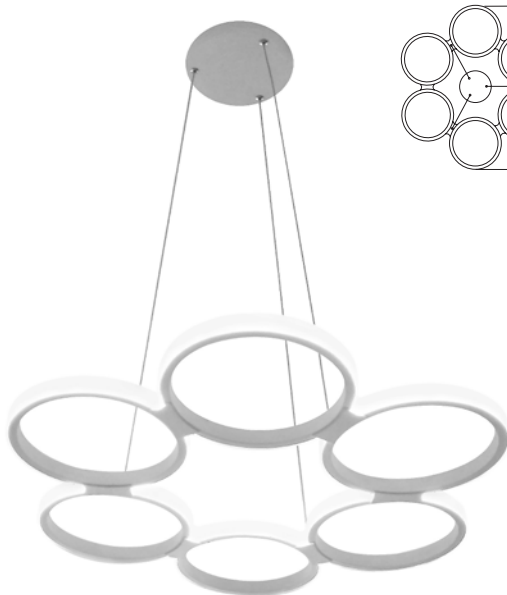

DECORATIVAS COLGANTES

EG-CAN-5W

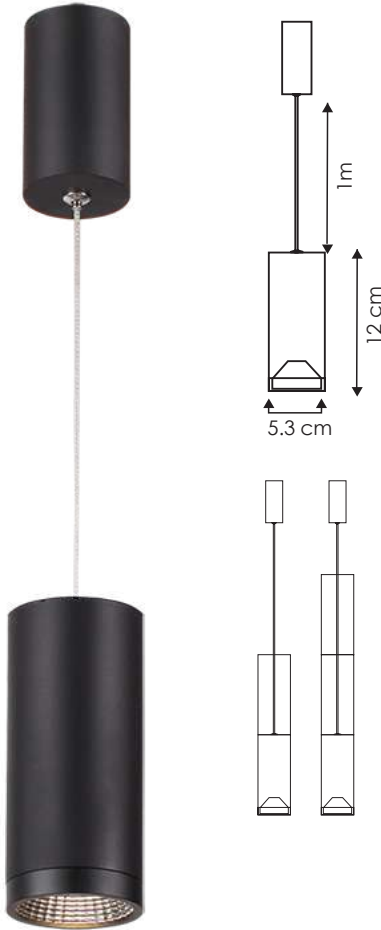

EG-CONAP-5W



*Se venden por separado.

Con el accesorio CONAP puedes aumentar la altura de la luminaria.

Enrosca la cantidad de accesorios que desees en la parte inferior. Usa tu creatividad para hacer un conjunto de luminarias colgantes.



5W

3,000 K
100-240V~

35,000 h
45°
IP50

350 lm
700 g



DECORATIVAS COLGANTES

EG-SA15

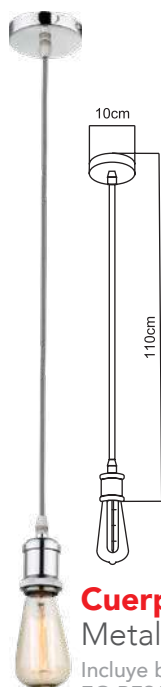

Cuerpo Metal

Incluye bombilla
EG-BFS6W-V

6W

- 2,200 K
- atenuable
- 127 V CA
- 35,000 h
- 360°

- IP20
- 740 lm
- 0.4 kg
- E26/27



EG-SA16

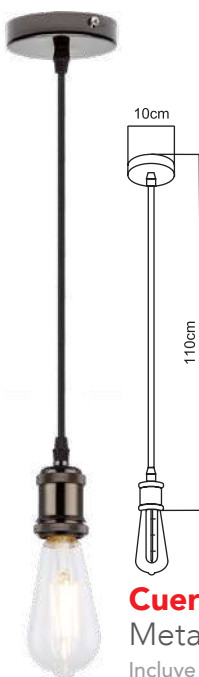

Cuerpo Metal

Incluye bombilla
EG-BFS6W-V

6W

- 2,200 K
- atenuable
- 127 V CA
- 35,000 h
- 360°

- IP20
- 740 lm
- 0.4 kg
- E26/27



EG-SA17

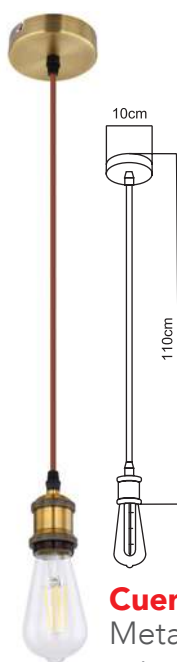

Cuerpo Metal

Incluye bombilla
EG-BFS6W-V

6W

- 2,200 K
- atenuable
- 127 V CA
- 35,000 h
- 360°

- IP20
- 740 lm
- 0.4 kg
- E26/27





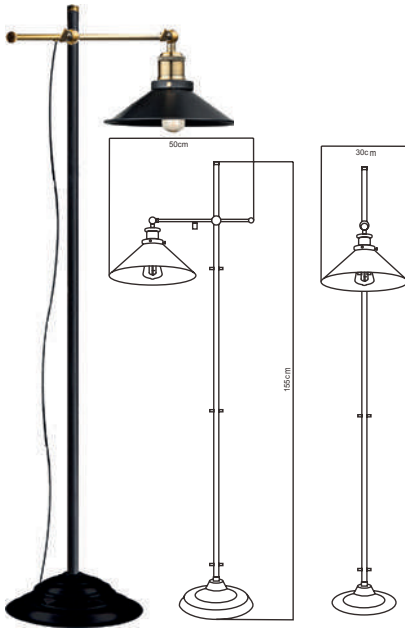





EG-LENIUS



Cuerpo
Metal

Incluye bombilla
EG-BF6W-V

6W

- 2,200 K
-  atenuable
-  127 V CA
-  35,000 h
-  220°
-  IP20
-  740 lm
-  E26/27
-  2.6 kg









EG-LENIUS3



Cuerpo
Metal

Incluye bombilla
EG-BFS6W-V

18W

- 2,200 K
-  atenuable
-  127 V CA
-  35,000 h
-  220°
-  IP20
-  2 220 lm
-  E26/27
-  6.5 kg



DECORATIVAS COLGANTES

EG-BLACKY



**Cuerpo
Metal**

Incluye bombillas
tipo vela
EG-BCF4W

32W

- 2,700 K
- 127 V CA
- 35,000 h
- 220°
- IP20
- 3 200 lm
- 6.5 kg
- E12

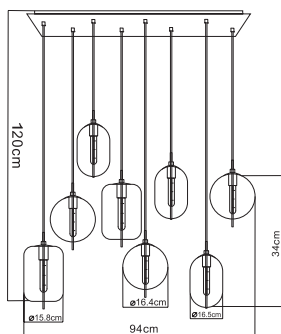

TIRAS LED

TIRAS LED

TIRAS LED

TIRAS LED

TIRAS LED

TIRAS LED

TIRAS LED

TIRAS LED

TIRAS LED



DECORATIVAS TIRAS LED



IP20



IP65



Se puede cortar donde
marca la línea punteada



Para el uso de correcto de las tiras RGB
LED adquiere el controlador RGB
EG-CRGB-E

EG-TL-3528-60LEDs

4.8W/m

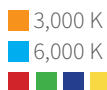

⚡ 12 V~

🕒 35,000 h

▲ 120°

💧 IP20

💧 IP65

📏 9 mm de ancho



EG-TL-5050-30LEDs

7.2W/m



⚡ 12 V~

🕒 35,000 h

▲ 120°

💧 IP20

💧 IP65

📏 11 mm de ancho



EG-TL-5050-60LEDs

14.4W/m



⚡ 12 V~

🕒 35,000 h

▲ 120°

💧 IP20

💧 IP65

📏 11 mm de ancho



Requieren su fuente de poder (EG-FP) . Busca los accesorios para tiras LED.

DECORATIVAS TIRA LED SMART

EG-TL-5050-MESH

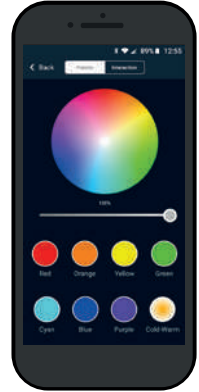

Para el control de esta
luminaria descarga la
aplicación

APP
MESH
LAMP



Se puede cortar donde
marca la línea punteada



Bluetooth 4.0



- Cambio de TCC
- Atenuable
- Cambio de Color
- Funciones interactivas (cambio de colores, strobe, ritmo, etc)

12W

- 3,000 K
- 6,000 K
- RGB

- ⚡ 24 V DC
- ⌚ 35,000 h
- ▲ 120°

- 💧 IP50
- ☀️ 960 lm/m
- ✂️ 1.4 cm de ancho



Incluye su fuente de poder y adaptador BT. Busca los accesorios para tiras MESH.

DECORATIVAS TIRA LED

EG-TL-5050-60LEDS-127V

6.4W/m

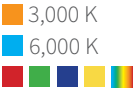

- ⚡ 127 V~
- 🕒 35,000 h
- ▲ 120°

- 💧 IP65
- 💡 620 lm/m
- 📏 1.5 cm de ancho
60 LEDS por m



*Aplica para RGB
EG-CRGB-127V

Para el uso correcto de las tiras LED adquiere el controlador, los conectores, soporte de tira y end caps.



EG-TL-SCOB

11W/m

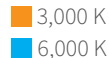

- ⚡ 24 V cd
- 🕒 35,000 h
- ▲ 120°

- 💧 IP20
- 💡 82 lm/m
- 📏 1.5 cm de ancho
60 LEDS por m

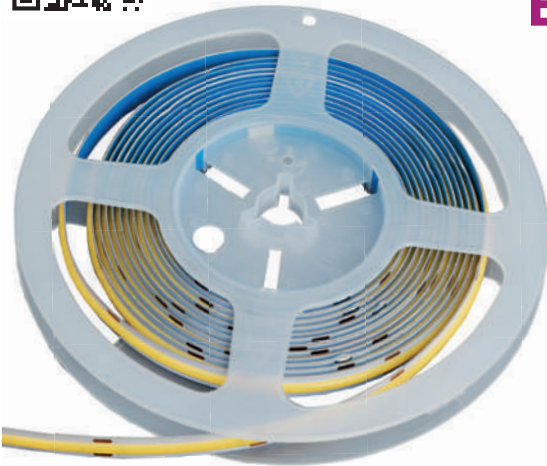

- Para unir dos o más tiras se requieren los accesorios (EG-TL-SCOB-STSL, EG-TL-SCOB-SC, EG-TL-SCOB-STSS).
- Requiere fuente de poder EG-FP-SCOB
- *Se venden por separado.

EG-TL-SCOB-50M

NUEVO



ROLLO DE
50m



Se puede cortar
cada 25cm

10 W/m

- 3,000 K
- 6,000 K

- 127 V~
- 35,000 h
- 120°

- IP65
- 70 lm/m
- 8 mm de ancho
288 LEDs por m

Para el uso correcto de las tiras LED
adquiere el controlador, los conectores,
soporte de tira y end caps.

Accesorios se venden por separado.



PERFILES PARA TIRA LED

Disponible: 3 m
color aluminio
cubierta opaca

EG-BL1701

NUEVO

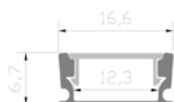

Se recomienda utilizar con tira led de ENER-GAIN. (EG-TL-5050-30LEDS, EG-TL-3528-60LEDS, EG-TLSCOB)

EG-BL1702

NUEVO



Se recomienda utilizar con tira led de ENER-GAIN. (EG-TL-5050-30LEDS, EG-TL-3528-60LEDS, EG-TLSCOB)

EG-BL-3001

NUEVO

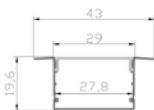

Se recomienda utilizar con tira led de ENER-GAIN. (EG-TL-5050-60LEDS, EG-TL-5050-30LEDS, EG-TL-3528-60LEDS, EG-TLSCOB, EG-TL-5050-60LEDS-25M)

EG-BL-1601

NUEVO

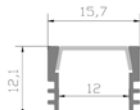
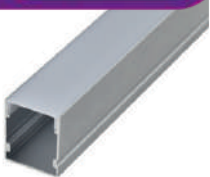

Se recomienda utilizar con tira led de ENER-GAIN. (EG-TL-5050-60LEDS, EG-TL-5050-30LEDS, EG-TL-3528-60LEDS, EG-TLSCOB)

EG-BL-1602

NUEVO

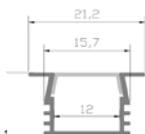

Se recomienda utilizar con tira led de ENER-GAIN. (EG-TL-5050-60LEDS, EG-TL-5050-30LEDS, EG-TL-3528-60LEDS, EG-TLSCOB)

EG-BL-1603

NUEVO

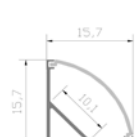

Se recomienda utilizar con tira led de ENER-GAIN. (EG-TL-5050-60LEDS, EG-TL-5050-30LEDS, EG-TL-3528-60LEDS, EG-TLSCOB, EG-TL-5050-60LEDS-25M)

LÁMPARAS

DE ACENTO

LÁMPARAS

DE ACENTO

LÁMPARAS

DE ACENTO

LÁMPARAS

DE ACENTO

LÁMPARAS

DE ACENTO



LÁMPARAS DE ACENTO

EG-AR111-15W



15W

- 3,000 K
- 4,000 K
- 6,500 K
- 100-240V~
- 25,000 h
- 38°
- IP50
- 1,500 lm
- 248 g
- G53
- versión atenuable



**NUEVO
MODELO**

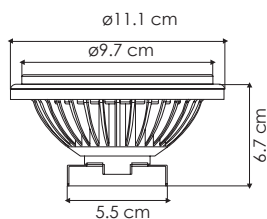

10W

- 3,000 K
- 6,000 K
- 100-240V~ / 127V~
- 25,000 h
- 25°
- IP50
- 700 lm
- 54 g
- E26/E27
- versión atenuable



EG-PAR20-10W



**NUEVO
MODELO**

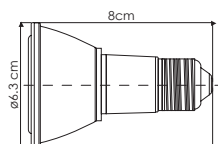

EG-PAR30-12W

**NUEVO
MODELO**



12W

- 3,000 K
- 6,000 K
- 100-240V~ / 127V~
- 25,000 h
- 38°
- IP50
- 1,020 lm
- 95 g
- E26/E27
- versión atenuable

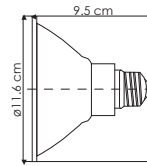

18W

- 3,000 K
- 6,000 K
- 100-240V~ / 127V~
- 25,000 h
- 38°
- IP50
- 1,620 lm
- 152 g
- E26/E27
- versión atenuable

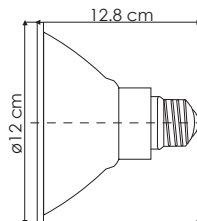

EG-PAR38-18W



**NUEVO
MODELO**

LÁMPARAS DE ACENTO

3W

- 3,000 K
- 6,000 K
- ■ ■ ■
- 85-130V~
- 25,000 h
- 120°
- IP20
- 265 lm
- 45 g
- GU 5.3
- GU 10

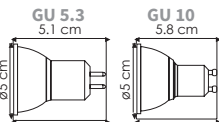

EG-SG3W



EG-S6W



6W

- 3,000 K
- 6,000 K
- 85-130V~
- 25,000 h
- 45°
- IP20
- 1,100 lm
- 40 g
- versión atenuable

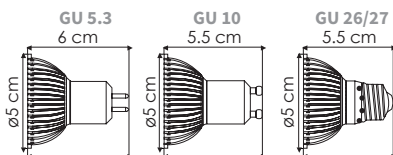

EG-S7W



7W

- 2,700 K
- 6,000 K

- 127V~
- 25,000 h
- 38°

- IP20
- 560 lm
- 32 g

- GU 5.3
- GU 10
- versión atenuable

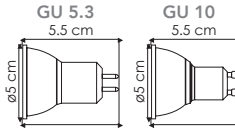

EG-S8W

8W

- 3,000 K
- 6,000 K

- 100-265 V~ atenuable
- 100-240 V~ no atenuable
- 25,000 h
- 45°

- IP20
- 650 lm
- 45 g

- GU 5.3
- GU 10
- E26/27

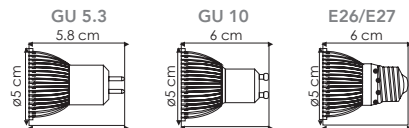

PORTALÁMPARA MR16 PARA DICROICOS

EG-SHELL-B1

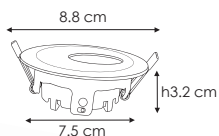

Direccional
Confort Visual

EG-SHELL-B2

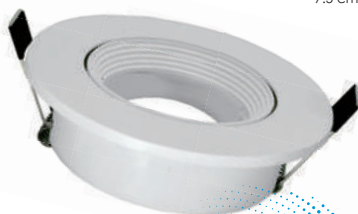
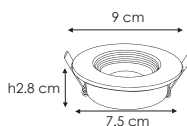

Direccional

EG-SHELL-B3



Máximo
Confort Visual

EG-SHELL-B4

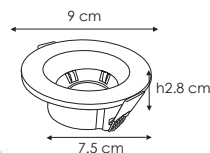

Cuerpo
Aluminio
y Cristal



IP53
Protección
contra el ambiente

IDEAL PARA BAÑOS

Diseños **Cuerpo**
ULTRA LIGERO Plástico

Aplicaciones en focos dicróicos (con base GU 5.3).
Instalación en caja cuadrada, bote o falso plafón.

incluyen dicróico 7w

■ 6,000 K

■ 2,700 K atenuable

PORTALÁMPARA MR16 PARA DICROICOS

EG-SHELL-G1

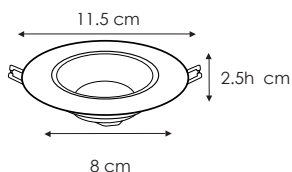

**Máximo
Confort Visual**



EG-SHELL-N1

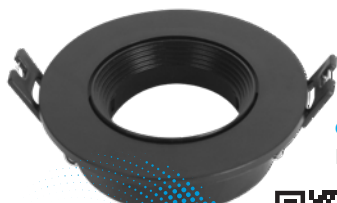
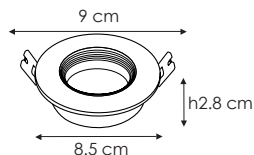

Cuerpo
Plástico

Direccional



EG-SHELL-S1

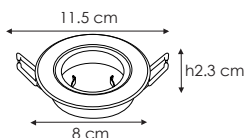

Direccional

EG-SHELL-B5

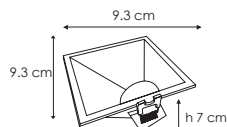

**Máximo
Confort Visual**



Diseños
ELEGANTES

Cuerpo
Plástico

Aplicaciones en focos dicróicos (con base GU 5.3).
Instalación en caja cuadrada, bote o falso plafón.

incluyen dicróico 7w

■ 6,000 K

■ 2,700 K  atenuable

PORTALÁMPARA MR16 PARA DICROICOS

EG-SHELL-B6

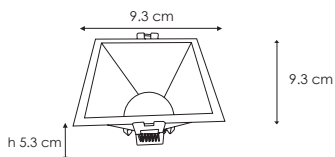

**Máximo
Confort Visual**



EG-SHELL-C1

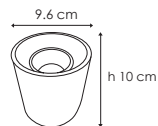

Direccional

*Disponible en color blanco o negro.

EG-SHELL-M1



Direccional

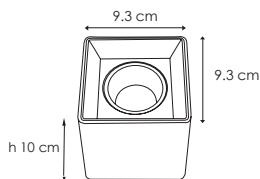

*Disponible en color blanco o negro.

Diseños

ULTRA LIGERO

Cuerpo

Plástico

Aplicaciones en focos dicróicos (con base GU 5.3). Instalación en caja cuadrada, bote o falso plafón.

incluyen dicróico 7w

■ 6,000 K

■ 2,700 K

■ atenuable

PORTALÁMPARA MR16 PARA DICROICOS

EG-SHELL-D1

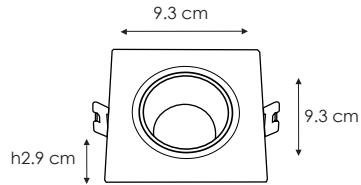

EG-SHELL-D2

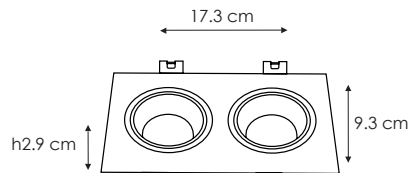

EG-SHELL-D3

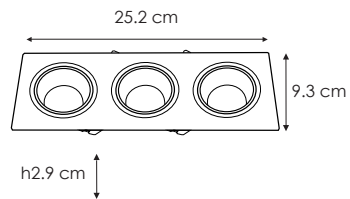

Diseños
FUNCIONALES

Cuerpo
Plástico

Aplicaciones en focos dicróicos (con base GU 5.3).
Instalación en caja cuadrada, bote o falso plafón.

incluyen dicróico 7w

■ 6,000 K

■ 2,700 K  atenuable

ACENTOS CARDÁN SERIE DD

EG-DD01-12W



12W

- 6,000 K
- 4,100 K
- 2,700 K

100-240V~

35,000 h

24°

IP50

1,020 lm

375 gr



24W

- 6,000 K
- 4,100 K
- 2,700 K

100-240V~

35,000 h

24°

IP50

2,040 lm

750 gr

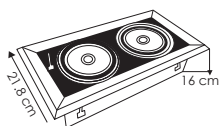
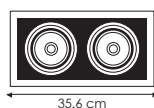

EG-DD02-24W

EG-DD03-36W

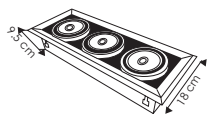
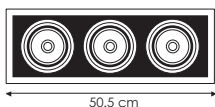

36W

- 6,000 K
- 4,100 K
- 2,700 K

100-240V~

35,000 h

24°

IP50

3,060 lm

1.5 kg



PREGUNTA POR LOS TIEMPOS DE ENTREGA

EG-C24-2W

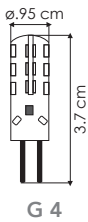

2W

- 6,000 K
- ⚡ 12 V DC
- 🕒 15,000 h
- ▲ 360°
- 💧 IP50
- 💡 200 lm
- ⚖️ 3 gr



EG-C64-3W

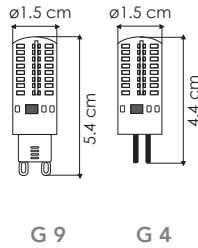

3W

- 3,000 K
- 6,000 K
- ⚡ 127 V AC
- 🕒 15,000 h
- ▲ 360°
- 💧 IP50
- 💡 330 lm
- ⚖️ 7 gr



EG-C104-5W

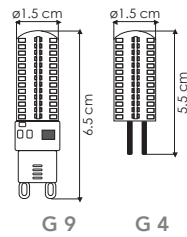

5W

- 3,000 K
- 6,000 K
- ⚡ 127 V AC
- 🕒 15,000 h
- ▲ 360°
- 💧 IP50
- 💡 500 lm
- ⚖️ 11 gr



ACENTOS

TRACK LIGHTS PARA RIEL

EG-TLS-18W



18W

4,100 K
3,000 K

100-240V~
35,000 h
30°

IP40
1,200 lm
678 gr

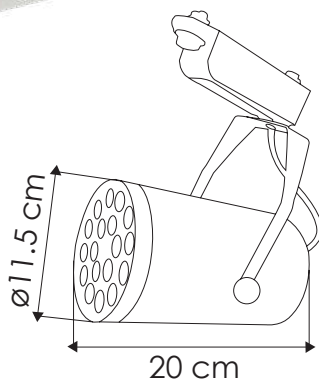

Instalación sobre EG-TRACK1-1M
ACCESORIOS SE VENDEN POR SEPARADO

ACENTOS TRACK LIGHTS PARA RIEL

EG-TLS-MR7W*

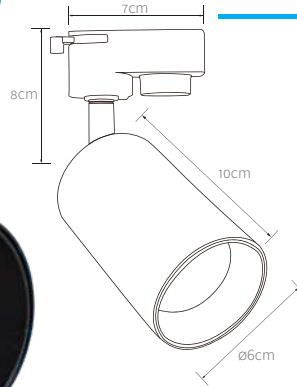

7W

- 6,000 K
- 2,700 K

- 100-265V~
- 35,000 h
- 36°

- IP20
- 600 lm
- 678 gr

Incluye dicroico 7W



*INSTALACIÓN SOBRE EG-TRACK-1M

7W

- 6,000 K
- 2,700 K

- 100-265V~
- 35,000 h
- 36°

- IP20
- 600 lm
- 678 gr

Incluye dicroico 7W

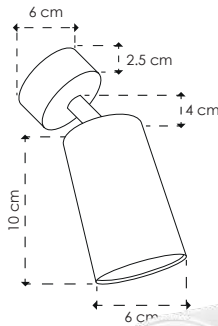

EG-TLS-MS7W*

BASE PARA
SOBREPONER



*El color del arillo interior puede ser elegido entre dorado, blanco, negro o plata.

ACENTOS

TRACK LIGHTS PARA RIEL

EG-TLS-20W



20W

- 6,000 K
- 3,000 K

- ⚡ 100-265V~
- ⌚ 35,000 h
- ▲ 24°

- 💧 IP20
- 💡 2,100 lm
- ⚖️ 240 gr



*INSTALACIÓN SOBRE EG-TRACK-1M

35W

- 3,000 K

- ⚡ 100-265V~
- ⌚ 35,000 h
- ▲ 24°

- 💧 IP20
- 💡 3,670 lm
- ⚖️ 670 gr



EG-TLS-35W



*INSTALACIÓN SOBRE EG-TRACK-1M

EG-BAR3-15W



Direccionable

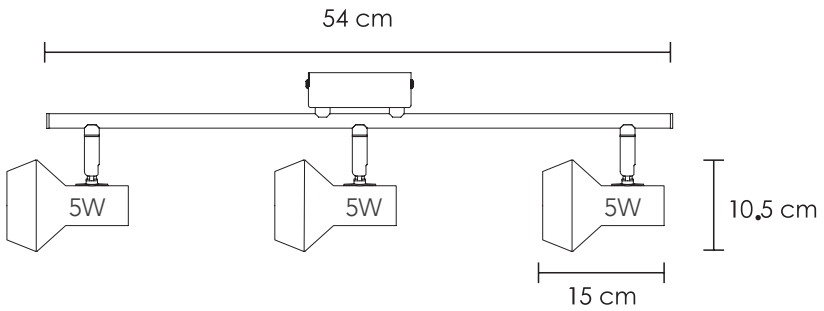

15W

3,000 K
100-240V~

IP20
35,000 h

1,200 lm
741 gr



LÁMPARAS LINEALES

LÁMPARAS LINEALES

LÁMPARAS LINEALES

LÁMPARAS LINEALES

LÁMPARAS LINEALES

LÁMPARAS LINEALES

LÁMPARAS LINEALES

LÁMPARAS LINEALES

LÁMPARAS LINEALES

LÁMPARAS LINEALES

LÁMPARAS LINEALES

T5

EG-T5-9W



La lámpara T5 se coloca dentro de la base G5 y cuenta con una fuente de poder integrada

Cubierta
OPAL

9W

- 6,000 K
- 4,100 K

- 100-277V~
- 35,000 h
- 180°

- IP50
- 900 lm
- 100 gr



EG-T5-18W

18W

- 6,000 K
- 4,100 K

- 100-277V~
- 35,000 h
- 180°

- IP50
- 1,800 lm
- 200 gr
- G5



LÁMPARAS LINEALES CON BASE T5C

EG-T5C-9W

9W

- 6,500 K
- 4,000 K
- 3,000 K

- 100-277V~
- 35,000 h
- 180°

- IP20
- 900 lm
- 100 gr

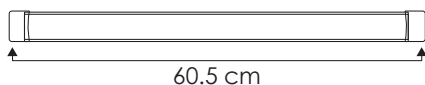

La lámpara T5C es un producto para sobreponer. Incluye un conector de corriente alterna y dos grapas para sobreponer.

Cubierta
OPAL



EG-T5C-18W

18W

- 6,500 K
- 4,000 K
- 3,000 K

- 100-277V~
- 35,000 h
- 180°

- IP20
- 1,800 lm
- 273 gr

**NUEVO
MODELO**

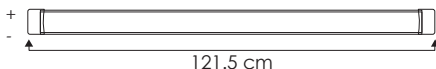

EG-T8-22W

22W

■ 5,000 K

⚡ 100-277V~

⌚ 50,000 h

▲ 180°

💧 IP50

☀️ 3,190 lm

⚖️ 254 gr

📏 G13

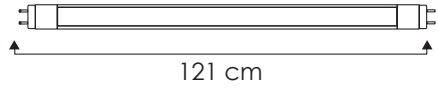

Cubierta

TRANSPARENTE

EG-T8-36W

36W

■ 6,000 K

⚡ 100-277V~

⌚ 35,000 h

▲ 180°

💧 IP50

☀️ 3,600 lm

⚖️ 400 gr

📏 Fa8

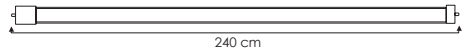

Cubierta
OPAL

Cubierta
TRANSPARENTE

Cuerpo
ALUMINIO
Y PC

LÁMPARAS LINEALES

T8

EG-T8C-9W

9W

- 6,000 K
- 4,100 K
- 3,000 K

- 100-277V~
- 35,000 h
- G13

- IP50
- 900 lm
- 100 gr

- 180° transparente
- 230° opal



59 cm

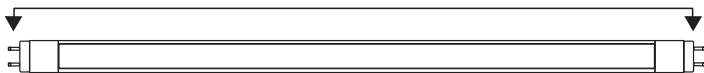

Cubierta
OPAL

Cubierta
TRANSPARENTE

Cuerpo
CRISTAL

LÁMPARAS LINEALES T8C

EG-T8C-18W

18W

- 6,000 K
- 4,100 K
- 3,000 K

- 100-277V~
- 35,000 h
- IP50
- 1,800 lm
- 208 gr
- G13/Fa8

- 180° transparente
- 230° opal

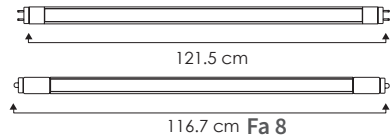

Cuerpo CRISTAL Cubierta OPAL Cubierta TRANSPARENTE



EG-T8C-40W

40W

Cubierta OPAL Cubierta TRANSPARENTE Cuerpo CRISTAL

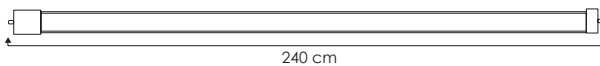

- 6,000 K
- 100-277V~
- 35,000 h

- IP50
- 4,000 lm
- 500 gr
- Fa8

- 180° transparente
- 230° opal

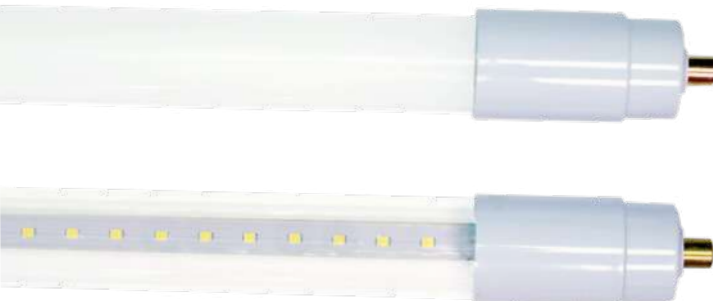

LÁMPARAS LINEALES T8 CURVALUM

EG-T8CUR-18W

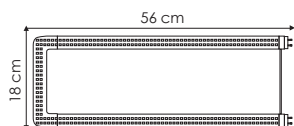

Cubierta
OPAL

Cubierta
TRANSPARENTE



18W

6,000 K
4,100 K

100-277V~

35,000 h

180°

IP50

1,800 lm

254 gr

G13



GABINETE ENVOLVENTE

EG-ENV-T8X2



100-277V~

120°

IP65

2.5 KG

G13

Compatible con lámparas:

EG-T8-22W

EG-T8C-18W

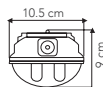

GABINETES INDUSTRIALES SERIE HBF

EG-HBF-4X18/22W



Usando 4 lámparas de 18W o 22W



Diagrama para suspender:

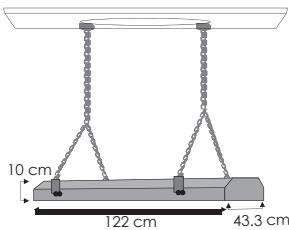

- *No incluye reflector parabólico
- *No incluye cadena.

Diagrama para fijar a superficie:



Diagrama para empotrar



Gabinete hecho de lámina calibre 26 fosfatizado y cubierto con pintura electrostática de horno con polvo blanco poliéster.

72W_{4x18w}

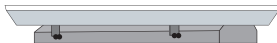
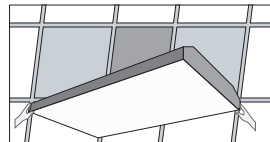
- 6,000 K
- 4,100 K
- 100-277V~
- 35,000 h
- 180°
- IP50
- 7,200 lm
- 6.3 Kg
- G13

88W_{4x22w}

- 6,000 K
- 4,100 K
- 100-277V~
- 35,000 h
- 180°
- IP50
- 12,320 lm
- 6.3 Kg
- G13

LÁMPARAS LINEALES SERIE HBF



Usando 6 lámparas de 18W o 22W

EG-HBF-6X18/22W



Diagrama para suspender:

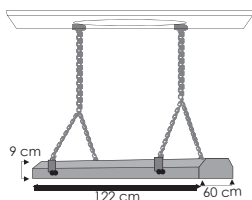

- *No incluye reflector parabólico
- *No incluye cadena.

Diagrama para fijar a superficie:



Diagrama para empotrar

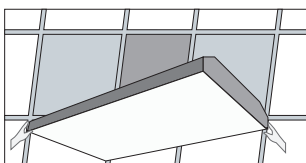

Gabinete hecho de lámina calibre 26 fosfatizado y cubierto con pintura electrostática de horno con polvo blanco poliéster.

108W 6x18w

- 6,000 K
- 4,100 K
- 100-277V~
- 35,000 h
- 180°
- IP50
- 10,800 lm
- 6.8 Kg
- G13

132W 6x22w

- 6,000 K
- 4,100 K
- 100-277V~
- 35,000 h
- 180°
- IP50
- 18,480 lm
- 6.8 Kg
- G13



GABINETES INDUSTRIALES SERIE HBF

EG-HBF-8X18/22W



Usando 8 lámparas de 18W o 22W



Diagrama para suspender:



Diagrama para empotrar



- *No incluye reflector parabólico
- *No incluye cadena.

Diagrama para fijar a superficie:

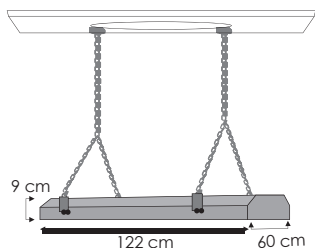
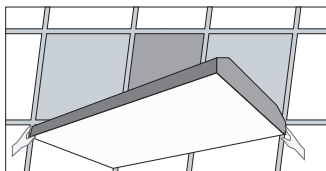
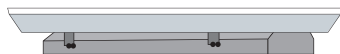

Gabinete hecho de lámina calibre 26 fosfatizado y cubierto con pintura electrostática de horno con polvo blanco poliéster.

144W 8x18w

- 6,000 K
- 4,100 K
- 100-277V~
- 35,000 h
- 180°
- IP50
- 14,400 lm
- 7.3 Kg
- G13

176W 8x22w

- 6,000 K
- 4,100 K
- 100-277V~
- 35,000 h
- 180°
- IP50
- 24,640 lm
- 7.3 Kg
- G13

BOMBILLAS

BOMBILLAS

BO AS

BO AS

BO AS

BO AS

BOM LLAS

BOM LLAS

BOMBILLAS

BOMBILLAS



EG-B9W-ECO

9W

- 6,000 K
- 3,000 K
- ⚡ 100-240V~
- ⌚ 25,000 h
- ▲ 220°
- 💧 IP50
- ☀️ 810 lm
- ⚖️ 65 gr
- 🔌 E26/27

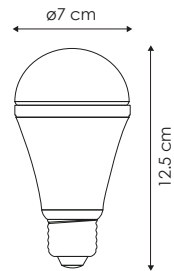

EG-B9W-TRIPACK

9W



- 6,000 K
- 3,000 K
- ⚡ 100-240V~
- ⌚ 25,000 h
- ▲ 220°
- 💧 IP50
- ☀️ 810 lm
- ⚖️ 65 gr
- 🔌 E26/27



BOMBILLAS SMART



- Cambio de TCC
- Atenuable
- Cambio de Color
- Funciones interactivas (cambio de colores, strobe, ritmo, etc)
- Programación de Tiempo



EG-B9W-MESH

9W

RGB+ 6,000 K+ 3,000 K

100-240V~

25,000 h

220°

IP50

750 lm

140 gr

E26/27



Bluetooth 4.0



APP
Control Remoto
Smartphone

Para el control de esta
luminaria descarga la
aplicación

APP
MESH
LAMP



BOMBILLAS ALTA POTENCIA

EG-BOMB-28W

28W

- 6,500 K
- 3,000 K

- 100-240V~
- 25,000 h
- 180°

- IP20
- 2700 lm
- gr
- E26/27

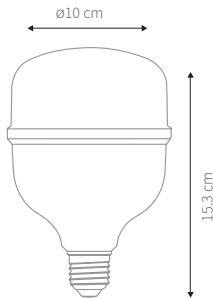

EG-BOMB-48W

48W

- 6,500 K
- 3,000 K

- 100-240V~
- 25,000 h
- 180°

- IP20
- 4,500 lm
- gr
- E26/27

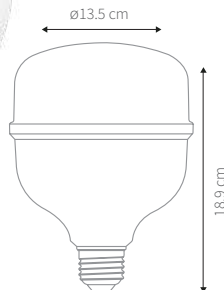

BOMBILLAS DE ALTA POTENCIA

EG-FYL30W

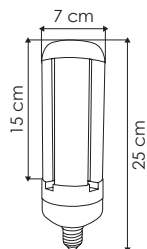

30W

- 6,000 K
- 3,000 K
- ⚡ 100-240V~
- 🕒 25,000 h
- ▲ 360°
- 💧 IP40
- 💡 2,950 lm
- ⚖ 248 gr
- 🔌 E26/27 - E39/E40



EG-K1045W

45W

- 5,000 K
- ⚡ 100-277V~
- 🕒 50,000 h
- ▲ 360°
- 💧 IP65
- 💡 6,750 lm
- ⚖ 960 gr
- 🔌 E26/27 - E39/E40

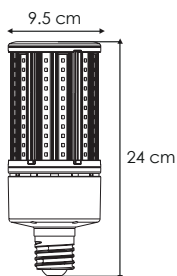

SERIE SUPEREFICIENTE
150 LÚMENES POR WATT

BOMBILLAS DE ALTA POTENCIA

EG-K1054W

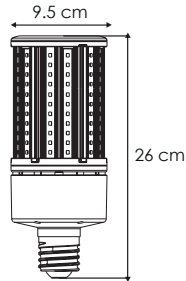

54W

- 5,000 K
- 100-277V~
- 50,000 h
- 360°
- IP65
- 8,100 lm
- 1.14kg
- E26/27* - E39/E40



EG-K1075W

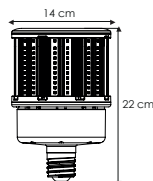

75W

5,000 K

- 100-277V~
- 50,000 h
- 360°
- IP65
- 11,250 lm
- 1.6kg
- E26/27* - E39/E40



*Bombillas con base E26/27 son bajo pedido.

BOMBILLAS VINTAGE FILAMENTOS

EG-BF4W

4W

- 2,700 K
- ⚡ 127V~
- 🕒 35,000 h
- ▲ 360°
- 💧 IP50
- 💡 450 lm
- ⚖ 15 gr
- 🔌 E26/27

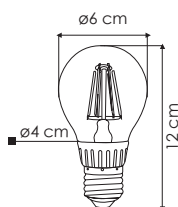
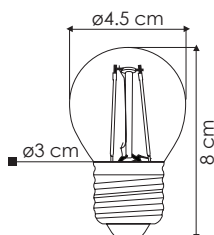

EG-BF6W

6W

- 2,700 K
- ⚡ 127V~
- 🕒 35,000 h
- ▲ 360°
- 💧 IP50
- 💡 740 lm
- ⚖ 35 g
- 🔌 E26/27

EG-BF6WW

6W

- 2,200 K
- ⊞ atenuable
- ⚡ 127V~
- 🕒 35,000 h
- ▲ 360°
- 💧 IP50
- 💡 740 lm
- ⚖ 35 g
- 🔌 E26/27

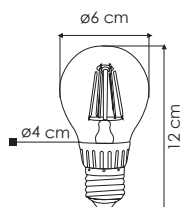

BOMBILLAS VINTAGE FILAMENTOS

EG-BFS6W



6W

- 2,700 K
- 127V~
- 35,000 h
- 360°
- IP50
- 740 lm
- 48 g
- E26/27

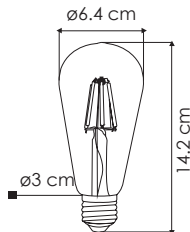

EG-BFS6W-V



6W

- 2,200 K
- atenuable
- 127V~
- 35,000 h
- 360°
- IP50
- 740 lm
- 48 g
- E26/27

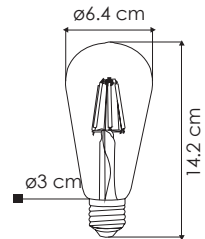

BOMBILLAS VINTAGE FILAMENTOS

EG-T185-6W

6W

- 2,200 K
- atenuable
- 127V~
- 35,000 h
- 360°
- IP50
- 740 lm
- 50 gr
- E26/27

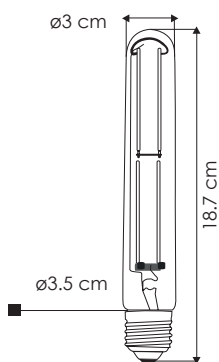

EG-BF12W

12W

- 2,700 K
- atenuable
- 127V~
- 35,000 h
- 300°
- IP50
- 1,200 lm
- 50 gr
- E26/27

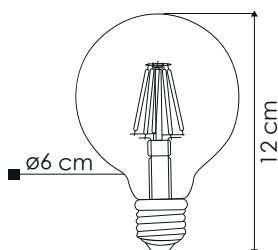

BOMBILLAS TIPO VELA

EG-BCF4W

4W

- 6,000 K
- 2,700 K

- 100-240 V~
- 35,000 h
- 220°
- IP50
- 440 lm
- E26/27 - E12
- 19.2gr

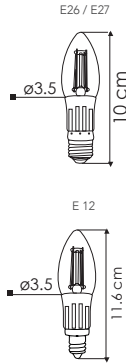

EG-BC4W

4W

- 6,000 K
- 3,000 K atenuable

- 127V~ /100-240V~
- 35,000 h
- 220°
- IP50
- 450 lm
- E26/27 - E12
- 48gr





GINEVA

2017





BAÑADORES DE PARED

EG-BP-BEAM



36W

RGBW

24V DC

50,000 h

15°

IP66

2,000 lm

2.3 Kg

25m

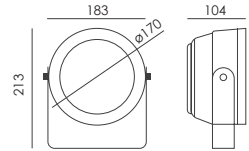

EG-BP-BD

36W

RGBW

24V DC

50,000 h

15°

IP66

1,900 lm

2.2 Kg

25m

DMX

GRAN VARIEDAD
ESCENARIOS
PROGRAMABLES

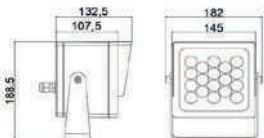

*Para estos modelos se necesita fuente de poder a 24V DC.

*Accesorios se venden por separado.

*Controlador DMX (EG-CRGB-DMX , EG-CON-WIFI-DMX)

*Para conectar a controlador se requieren conectores EG-CMH-24VDC

*Interconectables en serie.

CUERPO
ALUMINIO Y
VIDRIO TEMPLADO

BAÑADORES DE PARED LINEALES

EG-XL-024-D3

**NUEVO
MODELO**



24W

RGB 6,000 K
RGB 3,000 K

100-240V~
*24V dc
50,000 h
45°

IP65
1,210 lm
1.1 Kg
16m

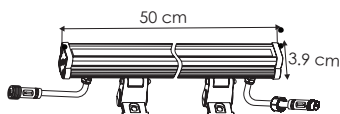
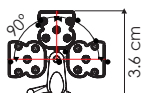

*Compatible con DMX

*Se requiere utilizar decodificar DMX

*Para estos modelos se necesita fuente de poder a 24 V DC (Sólo RGB) EG-FPWP

*Versión RGB necesita controlador EG-CON-01C

*Monocromáticos no requieren fuente de poder

*Estos accesorios se venden por separado.

*Para conectar más de 3 bañadores RGB, se requiere un amplificador RGB.

*Se utiliza 1 controlador EG-CON-01C por escenario.

CUERPO
ALUMINIO Y
VIDRIO TEMPLADO

BAÑADORES DE PARED LINEALES

EG-XL-048-D3

48W

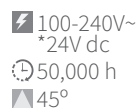
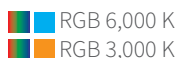

**NUEVO
MODELO**

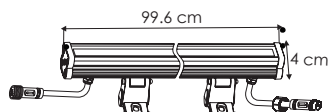
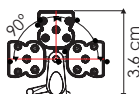

48W

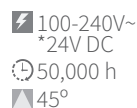
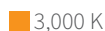

*Compatible con DMX

*Se requiere utilizar decodificar DMX

*Para estos modelos se necesita fuente de poder a 24 V DC (Sólo RGB) EG-FPWP

*Versión RGB necesita controlador EG-CON-01C

*Monocromáticos no requieren fuente de poder

*Estos accesorios se venden por separado.

*Para conectar más de 3 bañadores RGB, se requiere un amplificador RGB.

*Se utiliza 1 controlador EG-CON-01C por escenario.

CUERPO
ALUMINIO Y
VIDRIO TEMPLADO

BAÑADORES DE PARED LINEALES

EG-BP-RW500

INTERCONECTABLE
EN SERIE



18W

- IP65
- ☉ 1,380 lm
- ⚖ 900 g
- ▭ 10m

- 6,000 K
- 3,000 K
- RGB*
- ⚡ 24V dc
- ⌚ 50,000 h
- ▲ 8°

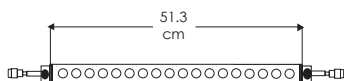
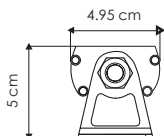

CUERPO
ALUMINIO Y
VIDRIO TEMPLADO

*Para estos modelos se necesita fuente de poder EG-FPWP.

*Versión RGB necesita controlador EG-CON-01C

*Estos accesorios se venden por separado

*Para conectar más de 3 bañadores RGB, se requiere un amplificador RGB.

*Se utiliza 1 controlador EG-CON-01C por escenario.

EG-BP-XL080

INTERCONECTABLE
EN SERIE

80W

DMX

GRAN VARIEDAD
ESCENARIOS
PROGRAMABLES



- RGBW*
- ⚡ 24V dc
- ▲ 15°
- ⌚ 50,000 h
- IP65
- ☉ 2,700 lm
- ⚖ 3.6 Kg
- ▭ 27m

*Se necesita fuente de poder de 24V EG-FPWP

*Requiere controlador DMX, EG-CRGB-DMX ó EG-CON-WIFI-DMX

* Requiere conectores EG-CMH-24VDC

*Estos accesorios se venden por separado.

CUERPO
ALUMINIO Y
VIDRIO TEMPLADO

Base

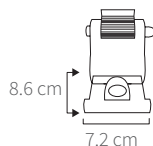
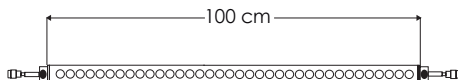

BAÑADORES DE PARED LINEALES

EG-BP-XL-100W

100W

RGB 3,000 K

100-240 V~

50,000 h

15°

IP67

65-80 lm/W

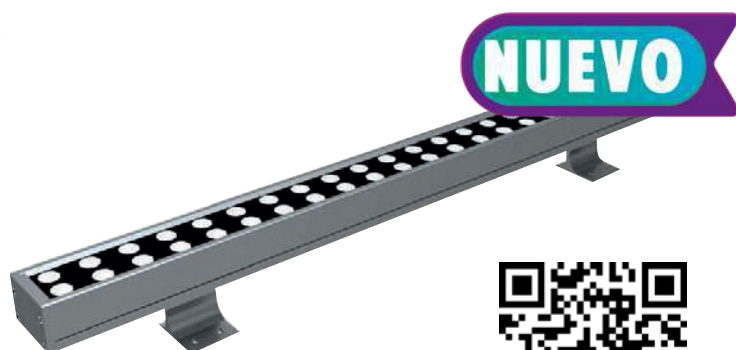

EG-BP-XL-180W

180W

RGB 3,000 K

100-240 V~

50,000 h

15°

IP67

65-80 lm/W



CORTESÍA EMPOTRABLES

EG-B106A-SET

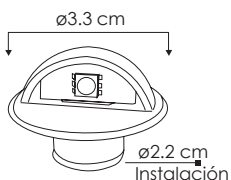

Incluye: Conector T y fuente de poder

0.4W por pieza

- 6,000 K
- 3,000 K
- amarillo
- azul

- 12V dc
- 35,000 h
- 90°

- IP67
- 28-40 lm
- 60g c/u



0.3W por pieza

- 6,000 K
- 3,000 K
- amarillo
- azul

- 12V dc
- 35,000 h
- 90°

- IP67
- 28-40 lm
- 60 g c/u



Incluye: Conector T y fuente de poder



EG-F102A-SET



CUERPO
ACERO INOXIDABLE
VIDRIO TEMPLADO

Estos luminarios cuentan con una fuente de poder multivoltaje de 100 - 240 V ~

CORTESÍA EMPOTRABLE

EG-DIAMOND



CUERPO
ALUMINIO Y PC

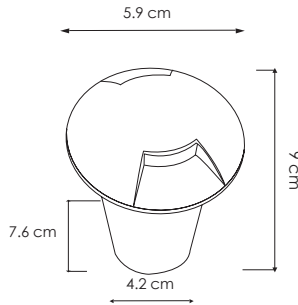

1 W

■ 3,000 K

⚡ 100-240V~

⌚ 50,000 h

▲ 40°

💧 IP67

☀️ 10 lm

⚖️ 360 g



EG-TORCH

1.2 W

■ 1,600 K

⚡ solar

⌚ 25,000 h

▲ 200°

💧 IP65

☀️ 1 lm

⚖️ 154 g

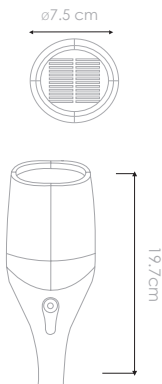

NUEVO



DECORATIVA CON ESTACA

EG-UN5W

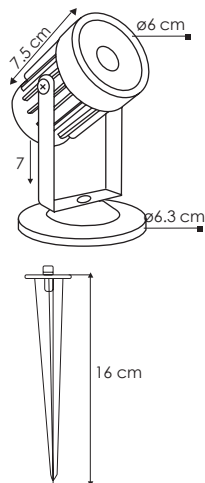

5 W

- 6,000 K
- 3,000 K
- Colores
- RGB automático
- 100-240 V ~
- 35,000 h
- 30°
- IP65
- 450 lm
- 260 g



EG-UN-15W

15W

- 6,000 K
- 3,000 K
- 100-240 V ~
- 35,000 h
- 30°
- IP65
- 1000 lm
- 550 g

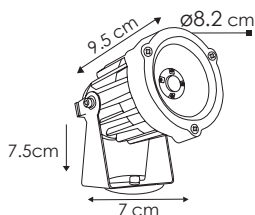
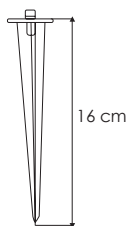

CUERPO
CRISTAL Y ALUMINIO

SUMERGIBLES PARA FUENTE Y ALBERCA

EG-LPF-12W

12W

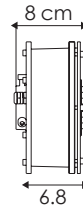
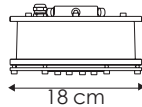
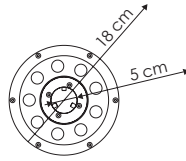

■ 6,000 K
■ 3,000 K
 Colores
■ ■ ■

⚡ 24V dc
⌚ 35,000 h
▲ 45°

💧 IP68
💡 1200 lm
📦 1.6 kg



- *Sumergible a 1m de profundidad.
- *Interconectable
- *Requiere fuente de poder EG-FWP-24V.
- *RGB requiere controlador EG-CON01C.
- *Interconectable en serie.

EG-LPA56-20W

20W

■ 6,000 K
■ 3,000 K
 Colores
■ ■ ■

⚡ 12V dc
⌚ 35,000 h
▲ 120°

💧 IP68
💡 2000 lm
📦 1.3kg

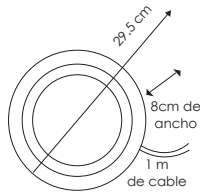

- *Sumergible a 1m de profundidad.
- *No Interconectable
- *Requiere fuente de poder EG-FP-12V.
- *RGB requiere controlador EG-CON01C.

CUERPO
 ACERO INOXIDABLE 304
 VIDRIO TEMPLADO

UP LIGHTS EMPOTRABLES AL PISO

EG-EP-1W

1 W



- 6,000 K ⚡ 100-240 V ~ 💧 IP65
- 3,000 K 🕒 35,000 h 💡 100 lm
- Colores ▲ 30° ⚖️ 280 g
- ■

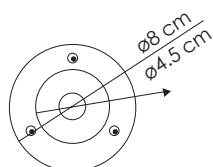
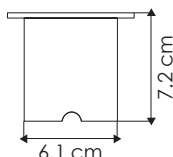

3 W

EG-EP-3W

- 6,000 K ⚡ 100-240 V ~ 💧 IP65
- 3,000 K 🕒 35,000 h 💡 300 lm
- Colores ▲ 30° ⚖️ 460 g
- ■

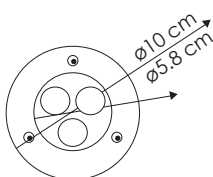
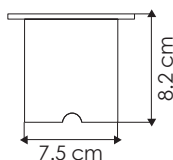

EG-EP-6W

6 W



- 6,000 K ⚡ 100-240 V ~ 💧 IP65
- 3,000 K 🕒 35,000 h 💡 600 lm
- Colores ▲ 30° ⚖️ 800 g
- ■

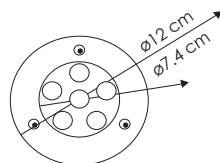
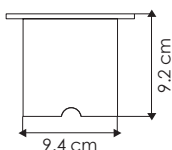

UP LIGHTS EMPOTRABLES AL PISO

EG-EP-9W

9 W

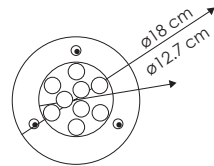
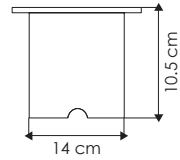

- | | | |
|-----------|---------------|----------|
| ■ 6,000 K | ⚡ 100-240 V ~ | 💧 IP65 |
| ■ 3,000 K | ⌚ 35,000 h | 💡 900 lm |
| Colores | ▲ 30° | ⚖ 1.48 g |
| ■ ■ | | |

20W

EG-EPCOB-20W

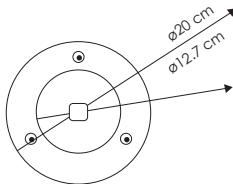
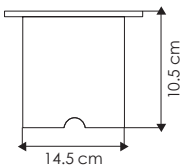

- | | | |
|-----------|---------------|-----------|
| ■ 6,000 K | ⚡ 100-240 V ~ | 💧 IP65 |
| ■ 3,000 K | ⌚ 35,000 h | 💡 2200 lm |
| Colores | ▲ 30° | ⚖ 1.68 g |
| ■ ■ | | |



CUERPO
ACERO INOXIDABLE 304
VIDRIO TEMPLADO

BAÑADORES DE PARED EMPOTRABLE AL PISO

EG-YS305D-18W

18W



- 6,000 K
- 3,000 K
- ⚡ 100-240V~

- RGBW*
- ⚡ 24V CD

- ⌚ 35,000 h
- ▲ 15°

- 💧 IP67
- 💡 1,350 lm
- 💡 1,450 lm
- ⚖️ 2.5 Kg

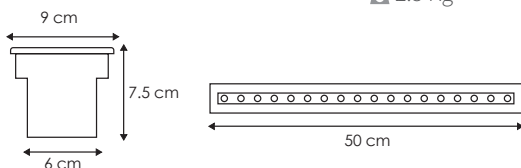

36W

EG-YS305D-36W

- 6,000 K
- 3,000 K
- ⚡ 100-240V~

- RGBW*
- ⚡ 24V CD

- ⌚ 35,000 h
- ▲ 15°

- 💧 IP67
- 💡 2,750 lm
- 💡 2,900 lm
- ⚖️ 5.2 Kg

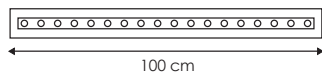
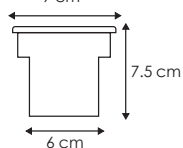

CUERPO
ALUMINIO
VIDRIO TEMPLADO

*Para RGBW requiere fuente de poder 24 V DC (EG-FPWP-24V) y controlador DMX EG-CRGB-DMX o EG-CON-WIFI-DMX, son interconectables.

*Colores monocromaticos en 6,000K y 3,000K no requieren fuente de poder, no son interconectables.

LUMINARIO SOBREPONER

EG-DRUM-10W

10W



- 3,000 K
- 100-240V~
- 35,000 h
- 110°
- IP55
- 900 lm
- 421 g

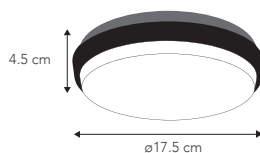

CUERPO
HIERRO FUNDIDO
Y POLICARBONATO

3W

EG-ROCKEP-3W

- 3,000 K
- 100-240V~
- 35,000 h
- 110°
- IP65
- 250 lm
- 436 g

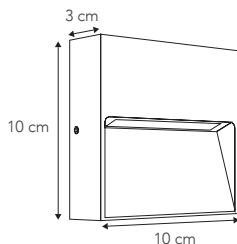

CUERPO
HIERRO FUNDIDO
Y CRISTAL

LUMINARIO TIPO BOLARDO

EG-STICKUP-12W

12W

3,000 K

100-240 V~

25,000 h

170°

IP65

780 lm

2.4 Kg

CUERPO

HIERRO FUNDIDO
Y POLICARBONATO

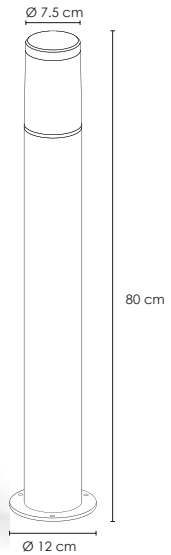

EG-TOWER

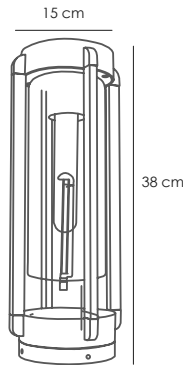

6W

2,200 K

127V~

35,000 h

360°

IP65

740 lm

2.13 kg



LUMINARIO TIPO ARBOTANTE

EG-ROMA-6W

6W

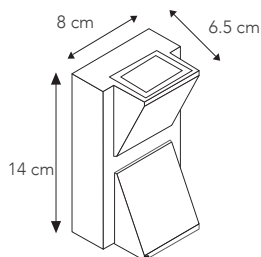
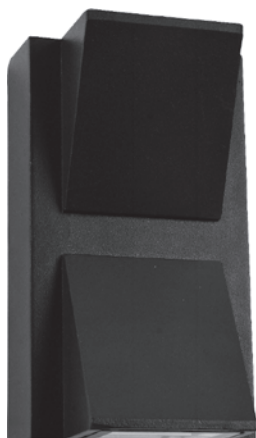

3,000 K

100-265V~

35,000 h

90°

IP65

380 lm

421 g



DISEÑO DE LUZ
BIDIRECCIONAL

CUERPO
HIERRO FUNDIDO
Y POLICARBONATO

6W

EG-MOSCU-6W

3,000 K

100-265V~

35,000 h

120°

IP65

320 lm

436 g

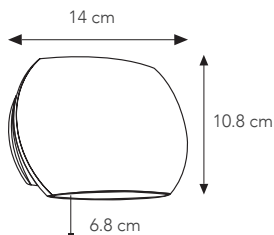

DISEÑO DE LUZ
BIDIRECCIONAL

CUERPO
HIERRO FUNDIDO
Y CRISTAL

LUMINARIO TIPO ARBOTANTE

EG-CAIRO-12W

12W

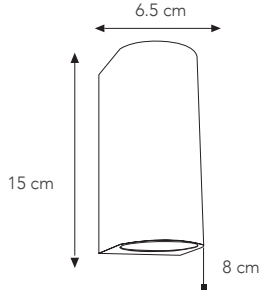

3,000 K

100-265V~

35,000 h

90°

IP65

720 lm

490 g



DISEÑO DE LUZ
BIDIRECCIONAL

CUERPO
HIERRO FUNDIDO
Y CRISTAL

6W

EG-MONACO-6W

3,000 K

100-265V~

35,000 h

45°

IP65

380 lm

512 g

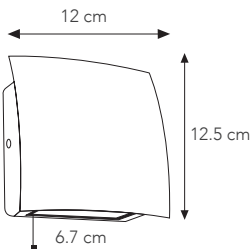

CUERPO
HIERRO FUNDIDO
Y CRISTAL

LUMINARIO TIPO ARBOTANTE

EG-MILAN-6W

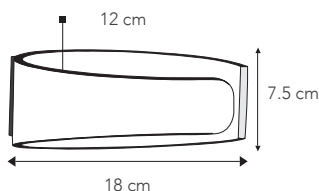
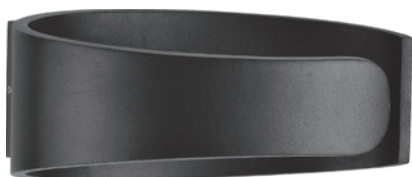

6W

3,000 K

100-265V~

35,000 h

160°



350 lm

632 g

CUERPO
HIERRO PUNDO
Y CRISTAL

LUMINARIO TIPO EMPOTRABLE

EG-OSLO-3W

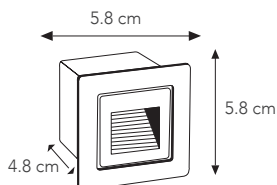
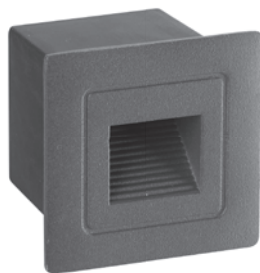

3W

3,000 K

100-265V~

35,000 h

45°



190 lm

110 g

CUERPO
CRISTAL Y
ALEACIÓN DE ALUMINIO

LUMINARIO TIPO ARBOTANTE

EG-R44AB-4W

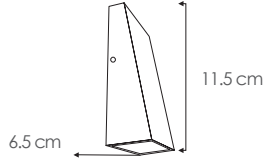

4W

3,000 K

100-240V~

35,000 h

15°

IP65

360 lm

210 g

4W

3,000 K

100-240V~

35,000 h

15°

IP65

360 lm

345 g

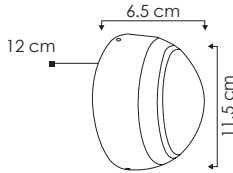

EG-R43SB-4W



EG-ARCU-3W

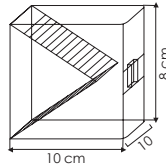

3W

3,000 K

100-240V~

35,000 h

45°

IP65

240 lm

240 g

LUMINARIO TIPO ARBOTANTE

EG-NEWYORK



DISEÑO DE LUZ
BIDIRECCIONAL

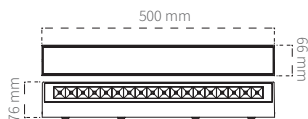

28W

3 000 K
100-240 V~

90°
25,000 h

IP65
1,597 lm
DISPONIBLE EN:
Negro y blanco mate.

CUERPO
ALEACIÓN DE
ALUMINIO

ARBOTANTE SOLAR AUTÓNOMO

EG-MARTE



4,000 K
2,000 ciclos
45°
IP65
200 lm
1.1 kg

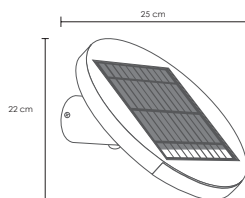

Modo 1: Cuando anochece, la luminaria encenderá de manera automática, cuando detecte movimiento la luminaria alcanzará el 100% de su potencia y al no detectar movimiento su intensidad bajará al 5% en 30 segundos.

Modo 2: Encendido continuo, hasta agotar la carga.

CUERPO
POLICARBONATO Y
ALEACIÓN DE ALUMINIO

BOLARDO SOLAR AUTÓNOMO

EG-APOLO

3W

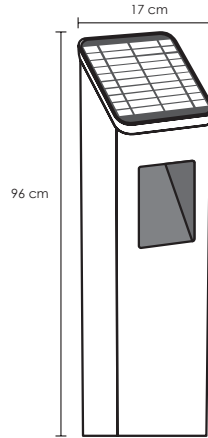

■ 4,000 K

🕒 2000 ciclos

▲ 40°

💧 IP65

☀️ 100 lm



Cuando anochece, la luz encenderá automáticamente.

MODO 1: Cuando la luminaria detecte movimiento, su intensidad alcanzará el 100% de su potencia. Y al no detectar movimiento, la intensidad bajará al 5% en 15 segundos.

MODO 2: Presione el botón por segunda vez. Cuando la luminaria detecte movimiento, su intensidad alcanzará el 100% de su potencia y al no detectar movimiento se apagará después de 15 segundos.

MODO 3: Presione el botón por tercera vez. La luz se apaga.



CUERPO
POLICARBONATO Y
ALEACIÓN DE ALUMINIO

REFLECTORE

REFLECTORE

REFLECTORE

REFLECTORE

REFLECTORE

REFLECTORE

REFLECTORE

REFLECTORE

REFLECTORE

REFLECTORE



REFLECTORES SERIE FL

EG-FL-10W-RGB

**NUEVO
MODELO**



10W

RGB*

100-240V~

35,000 h

180°

IP66

270 lm

374 g

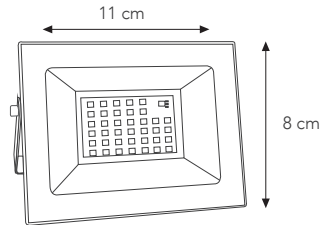

EG-FL-30W-RGB

**NUEVO
MODELO**



30W

RGB*

100-240V~

30,000 h

120°

IP65

870 lm

1.14Kg

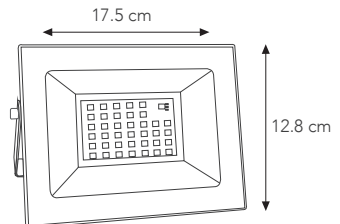

CUERPO

ALUMINIO Y
CRISTAL TEMPLADO

*Incluye control remoto para cambio de color.

REFLECTORES

SERIE FL

EG-FL-50W-RGB



50W

RGB*



⚡ 100-240V~

🕒 35,000 h

📐 120°

💧 IP65

☀️ 35 lm/W

📦 1.65 Kg

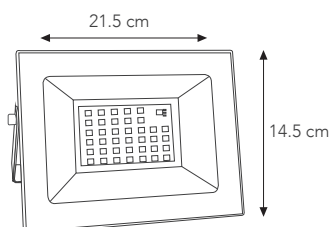

*Incluye control remoto para cambio de color.

EG-FL-100W

100W



🔵 6,000 K

🟠 3,000 K

⚡ 100-277 V~

🕒 35,000 h

📐 180°

💧 IP66

☀️ 110lm/W

📦 4.28 kg

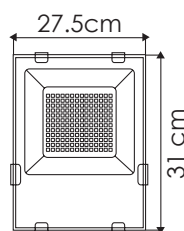

7.5 cm

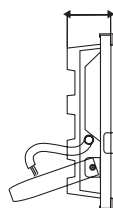

CUERPO

ALUMINIO Y
CRISTAL TEMPLADO



REFLECTORES SERIE FL

EG-FL-150W



150W



- 6 000 K
- 100-277V~
- 35,000 h
- 180°
- IP66
- 110 lm/W
- 4.6 kg

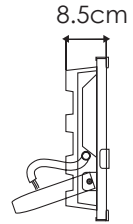
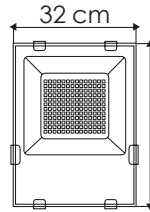

EG-FL-200W



200W



- 6,000 K
- 100-277 V~
- 35,000 h
- 180°
- IP66
- 110 lm/W
- 4.6 kg

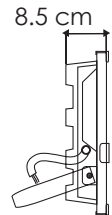
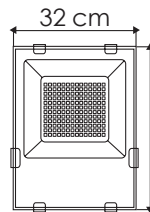

CUERPO
ALUMINIO Y
CRISTAL TEMPLADO



REFLECTORES SERIE FL

EG-FL-300W

300W

- 6 000 K
- 100-277V~
- 35,000 h
- 180°
- IP66
- 110 lm/W
- 6.2 Kg

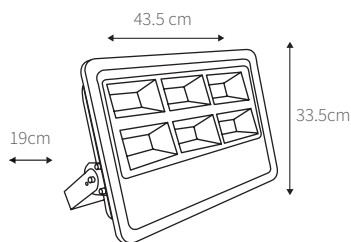

EG-FL-400W

400W

- 6 000 K
- 100-277V~
- 35,000 h
- 180°
- IP66
- 110 lm/W
- 8.5 Kg

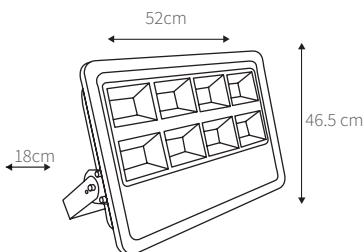

REFLECTORES SERIE FL ECO

EG-FL-10W-ECO



10W

- 6,000 K
- 3,000 K

100-277 V ~

50,000 h

100°

IP65

950 lm

320 g

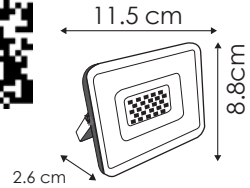

EG-FL-20W-ECO



20W

- 6,000 K
- 3,000 K

100-277 V ~

50,000 h

100°

IP65

2,000 lm

410 g

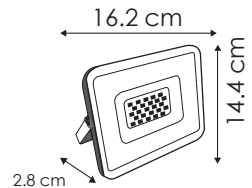

CUERPO
ALUMINIO
Y CRISTAL



REFLECTORES SERIE FL ECO

EG-FL-30W-ECO



30W

- 6,000 K
- 3,000 K
- 100-277 V ~
- 50,000 h
- 100°
- IP65
- 3,000 lm
- 570 g

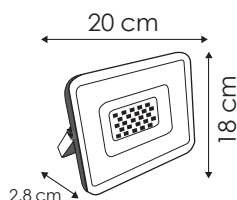

EG-FL-50W-ECO



50W

- 6,000 K
- 3,000 K
- 100-277 V ~
- 50,000 h
- 100°
- IP66
- 5,000 lm
- 4.6 kg

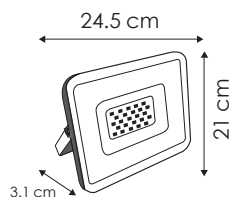

CUERPO
ALUMINIO
Y CRISTAL

REFLECTORES SERIE FL MEKA

EG-FL-10W-MEKA



10W

- 6,000 K
- ⚡ 100-240 V ~
- 🕒 50,000 h
- ▲ 108°
- 💧 IP65
- ☀️ 1,000 lm
- 📦 0.10 kg

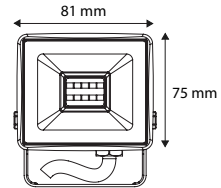
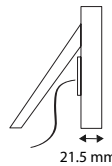

EG-FL-20W-MEKA



20W

- 6,000 K
- ⚡ 100-240 V ~
- 🕒 50,000 h
- ▲ 108°
- 💧 IP65
- ☀️ 2,000 lm
- 📦 0.18 kg

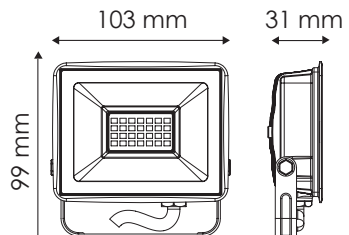

CUERPO
ALUMINIO
Y CRISTAL

REFLECTORES SERIE FL MEKA

EG-FL-30W-MEKA



30W

- 6,000 K
- ⚡ 100-240 V~
- 🕒 50,000 h
- ▲ 108°
- 💧 IP65
- 💡 3,000 lm
- 📦 0.265 kg

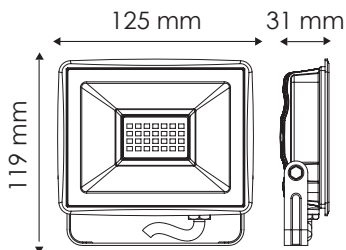

EG-FL-50W-MEKA



50W

- 6,000 K
- ⚡ 100-240 V~
- 🕒 50,000 h
- ▲ 108°
- 💧 IP65
- 💡 5,000 lm
- 📦 0.5 kg

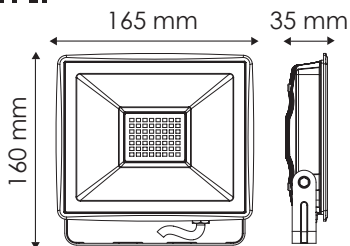

CUERPO
ALUMINIO
Y CRISTAL

REFLECTORES SERIE FL MEKA

EG-FL-100W-MEKA

100W



- 6,000 K
- ⚡ 100-240 V ~
- 🕒 50,000 h
- ▲ 108°
- 💧 IP65
- 💡 10,000 lm
- 📦 0.86 kg

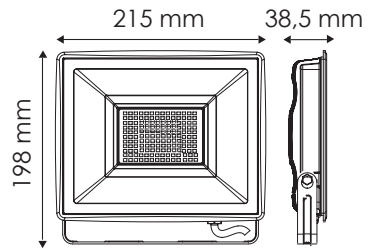

EG-FL-150W-MEKA

100W



- 6,000 K
- ⚡ 100-240 V ~
- 🕒 50,000 h
- ▲ 108°
- 💧 IP65
- 💡 18,000 lm
- 📦 1.76 kg

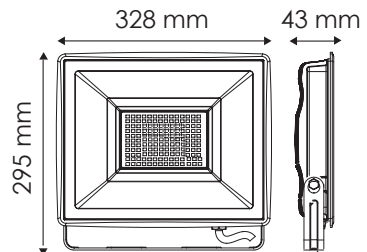

CUERPO
ALUMINIO Y
CRISTAL TEMPLADO

REFLECTORES SERIE FL MEKA

EG-FL-200W-MEKA



200W

- 6,000 K
- 100-240 V~
- 50,000 h
- 108°
- IP65
- 24,000 lm
- 2.84 kg

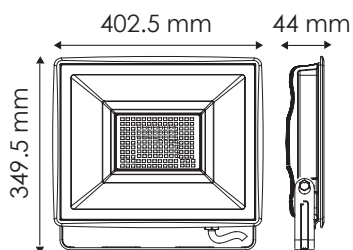

EG-FL-300W-MEKA



300W

- 6,000 K
- 100-240 V~
- 50,000 h
- 108°
- IP65
- 36,000 lm
- 4.46 kg

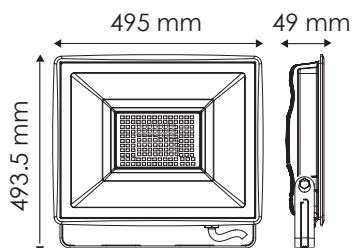

CUERPO
ALUMINIO Y
CRISTAL TEMPLADO

REFLECTORES SENSOR

EG-FL-50W-SENSOR

50W



■ 6,000 K

💧 IP65

☀️ 5,500 lm

📏 kg

⚡ 100-130 V ~

🕒 50,000 h

▲ 100°

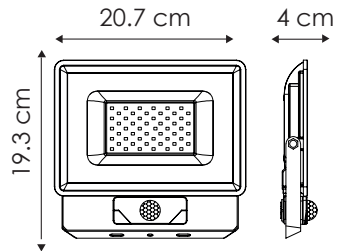

REFLECTORES SERIE FENIX

EG-FX-500W

SERIE SUPEREFICIENTE
160 LÚMENES POR WATT

500W



■ 6,000 K

💧 IP66

☀️ 80,000 lm

📏 9 kg

⚡ 100-277 V ~

🕒 50,000 h

▲ 60°

*Ángulos disponibles
15°, 45° y 90°

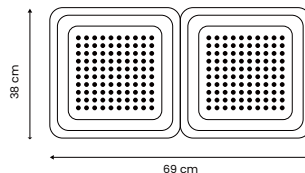

CUERPO
ALUMINIO
Y CRISTAL



REFLECTORES SERIE FENIX

EG-FX-750W

SERIE SÚPEREFICIENTE

160 LÚMENES POR WATT

750W

6,000 K

IP66

120,000 lm

14 kg

100-277 V~

50,000 h

*Ángulos disponibles
15°, 45° y 90°

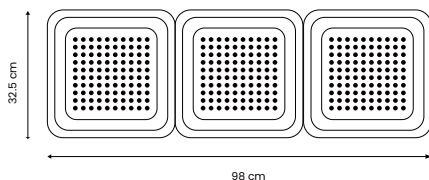

EG-FX-1000W

SERIE SÚPEREFICIENTE

160 LÚMENES POR WATT

1000W

6,000 K

IP66

160,000 lm

17.2 kg

100-277 V~

50,000 h

*Ángulos disponibles
15°, 45° y 90°

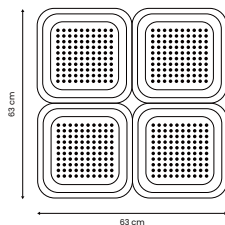

CUERPO
ALUMINIO
Y CRISTAL

EG-WALLPACK-80W



80W

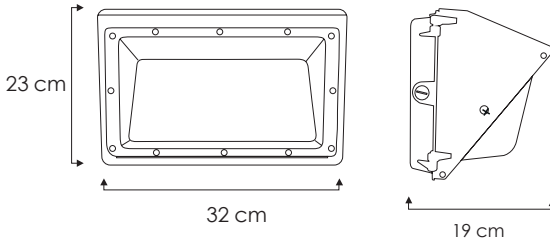

■ 5,000 K

⚡ 100-277 V ~

⌚ 50,000 h

▲ 120°

💧 IP65

☀ 9,000 lm

⚖ 3.1 kg



CUERPO
ALUMINIO Y PC

INDUSTRIAL

INDUSTRIAL

INDUSTRIAL

INDUSTRIAL

INDUSTRIAL

INDUSTRIAL

INDUSTRIAL

INDUSTRIAL

INDUSTRIAL



SERIE BAY HIGH-BAY

EG-LINK-100W

100W

5,500 K

100-277 V ~

35,000 h

60°

IP65

12,000 lm

1.9 kg

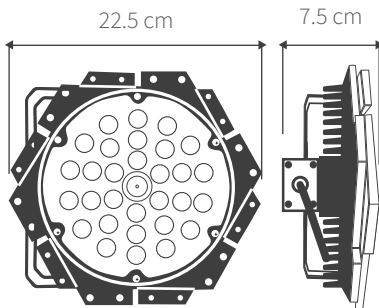

CUERPO

ALEACIÓN DE
ALUMINIO

Para multiplicar el efecto luminoso: ensambla bloques fácilmente.

SERIE BAY HIGH-BAY

EG-BAY-500W



500W

5,500 K 50,000 h IP65 18 kg
100-277 V~ 60° 45,000 lm

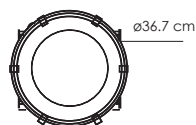
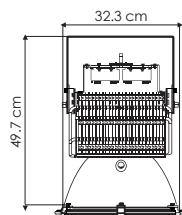

CUERPO
ALUMINIO



SERIE UFO HIGH-BAY

EG-PL-UFO

Luminaria UFO Serie K High Bay

Disponible

Para instalación
colgante
o sobreponer
Policarbonato 60°
Cristal Templado 120°



Protección
contra impactos



100W

■ 5,500 K

⚡ 100-277 V ~
⌚ 100,000 h
▲ 60°
▲ 120°
💧 IP65
☀️ 16,000 lm
⚖️ 3.2 kg



150W

■ 5,500 K

⚡ 100-277 V ~
⌚ 100,000 h
▲ 60°
▲ 120°
💧 IP65
☀️ 24,000 lm
⚖️ 3.2 kg



200W

■ 5,500 K

⚡ 100-277 V ~
⌚ 100,000 h
▲ 60°
▲ 120°
💧 IP65
☀️ 32,000 lm
⚖️ 4.2 kg



240W

■ 5,500 K

⚡ 100-277 V ~
⌚ 100,000 h
▲ 60°
▲ 120°
💧 IP65
☀️ 38,400 lm
⚖️ 4.2 kg



*Brazo se vende por separado

SERIE UFO HIGH-BAY

EG-PL-UFO-100W-ECO

NUEVO



Protección
contra impactos

100W

5,500 K
100-277 V~
50,000 h

90°
120°
IP65
160 lm/W
2 kg



EG-PL-UFO-150W-ECO

NUEVO



Protección
contra impactos

150W

5,500 K
100-277 V~
50,000 h

90°
120°
IP65
160 lm/W
2 kg



CUERPO
ALUMINIO Y
CRISTAL TEMPLADO

*Brazo se vende
por separado

EG-PL-UFO-200W-ECO

NUEVO



Protección
contra impactos

200W

■ 5,500 K
⚡ 100-277 V ~
⌚ 50,000 h

▲ 90°
▲ 120°
💧 IP65
☀️ 160 lm/W
⚖️ 2.5 kg



EG-PL-UFO-240W-ECO

NUEVO



Protección
contra impactos

240W

■ 5,500 K
⚡ 100-277 V ~
⌚ 50,000 h

▲ 90°
▲ 120°
💧 IP65
☀️ 160 lm/W
⚖️ 2.7 kg



CUERPO
ALUMINIO Y
CRISTAL TEMPLADO

*Brazo se vende
por separado

SERIE QD GASOLINERAS

EG-QD80H

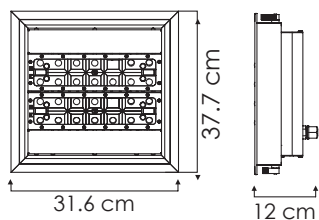

80W

- 5,000 K
- 100-277 V~
- 100-240 V~
- 60,000 h
- 60°
- 90°
- 110°

- IP65
- 13,200 lm
- 4.4 kg

EG-QD100H

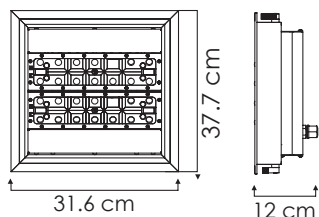

100W

- 5,000 K
- 100-277 V~
- 100-240 V~
- 60,000 h
- 60°
- 90°
- 110°

- IP65
- 16,000 lm
- 4.4 kg

CUERPO
ALUMINIO ANODIZADO

SERIE QD GASOLINERAS

EG-QD120H

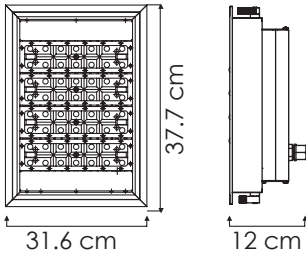

120W

- 5,000 K
- 100-277 V ~
- 100-240 V ~
- 60,000 h
- 60°
- 90°
- 110°
- IP65
- 18,600 lm
- 4.4 kg



CUERPO
ALUMINIO ANODIZADO

PREGUNTA POR LOS
TIEMPOS DE ENTREGA.

EG-SOS

LÁMPARA LED DE EMERGENCIA

6W

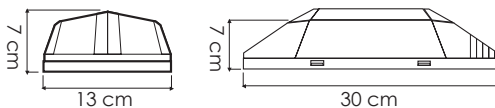

- 5,500 K
- 100-240 V ~
- 50,000 h
- 90°
- IP30
- 400 lm
- 501 g
- *3 horas de operación



VIALES

VIALES

VIALES

VIALES

VIALES

VIALES

VIALES

VIALES



Serie PREMIUM incluye **BASE CON FOTOCELDA**, en serie ESTÁNDAR se vende por separado.



VIALES SERIE LHD

EG-LHD-30W

30W

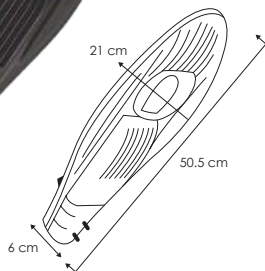

ESTÁNDAR

- 5,700 K
- ⚡ 100-277 V ~
- ⚡ 12-24 V DC
- 🕒 100,000 h
- 💧 IP66
- 💡 130 lm/W
- 💡 3,900 lm
- 📖 2.2 kg

PREMIUM

- 5,700 K
- ⚡ 100-277 V ~
- ⚡ 12-24 V DC
- 🕒 100,000 h
- 💧 IP66
- 💡 160 lm/W
- 💡 4,800 lm
- 📖 2.2 kg



EG-LHD-40W

40W

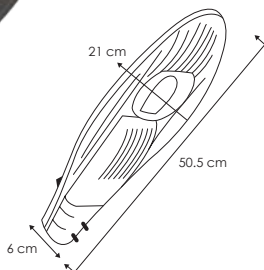

ESTÁNDAR

- 5,700 K
- ⚡ 100-277 V ~
- ⚡ 12-24 V DC
- 🕒 100,000 h
- 💧 IP66
- 💡 130 lm/W
- 💡 5,200 lm
- 📖 2.2 kg

PREMIUM

- 5,700 K
- ⚡ 100-277 V ~
- ⚡ 12-24 V DC
- 🕒 100,000 h
- 💧 IP66
- 💡 160 lm/W
- 💡 6,400 lm
- 📖 2.2 kg



CUERPO
ALUMINIO PURO



PAESE
Programa de Ahorro de Energía
del Sector Eléctrico

*Solo la serie LHD PREMIUM cuenta con el certificado PAESE



VIALES SERIE LHD



Serie PREMIUM incluye **BASE CON FOTOCELDA**, en serie ESTÁNDAR se vende por separado.

EG-LHD-50W

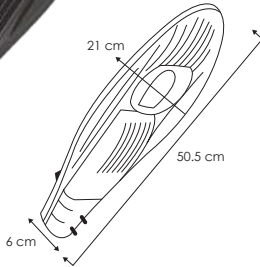

ESTÁNDAR

- 5,700 K
- ⚡ 100-277 V ~
- ⚡ 12-24 V DC
- 🕒 100,000 h

- 💧 IP66
- 💡 130 lm/W
6,500 lm
- 📖 2.2 kg



PREMIUM

- 5,700 K
- ⚡ 100-277 V ~
- ⚡ 12-24 V DC
- 🕒 100,000 h

- 💧 IP66
- 💡 160 lm/W
8,000 lm
- 📖 2.9 kg



EG-LHD-60W

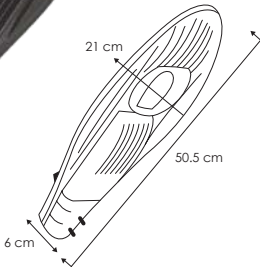

ESTÁNDAR

- 5,700 K
- ⚡ 100-277 V ~
- ⚡ 12-24 V DC
- 🕒 100,000 h

- 💧 IP66
- 💡 130 lm/W
7,800 lm
- 📖 2.2 kg



PREMIUM

- 5,700 K
- ⚡ 100-277 V ~
- ⚡ 12-24 V DC
- 🕒 100,000 h

- 💧 IP66
- 💡 160 lm/W
9,600 lm
- 📖 2.9 kg



CUERPO
ALUMINIO PURO



PAESE
Programa de Ahorro de Energía del Sector Eléctrico

*Solo la serie LHD PREMIUM cuenta con el certificado PAESE



Serie PREMIUM incluye **BASE CON FOTOCELDA**, en serie ESTÁNDAR se vende por separado.



VIALES SERIE LHD

EG-LHD-80W



ESTÁNDAR

- 5,700 K
- ⚡ 100-277 V ~
- ⚡ 12-24 V DC
- ⌚ 100,000 h
- 💧 IP66
- ☀️ 130 lm/W
- 10,400 lm
- ⚖️ 4.6 kg



80W

PREMIUM

- 5,700 K
- ⚡ 100-277 V ~
- ⚡ 12-24 V DC
- ⌚ 100,000 h
- 💧 IP66
- ☀️ 160 lm/W
- 12,800 lm
- ⚖️ 4.6 kg



EG-LHD-100W



ESTÁNDAR

- 5,700 K
- ⚡ 100-277 V ~
- ⚡ 12-24 V DC
- ⌚ 100,000 h
- 💧 IP66
- ☀️ 130 lm/W
- 13,000 lm
- ⚖️ 4.7 kg



100W

PREMIUM

- 5,700 K
- ⚡ 100-277 V ~
- ⚡ 12-24 V DC
- ⌚ 100,000 h
- 💧 IP66
- ☀️ 160 lm/W
- 16,000 lm
- ⚖️ 4.7 kg



CUERPO
ALUMINIO PURO



PAESE
Programa de Ahorro de Energía
del Sector Eléctrico

*Solo la serie LHD PREMIUM cuenta con el certificado PAESE



VIALES SERIE LHD



Serie PREMIUM incluye **BASE CON FOTOCELDA**, en serie ESTÁNDAR se vende por separado.

EG-LHD-120W



ESTÁNDAR

- 5,700 K
- ⚡ 100-277 V ~
- ⚡ 12-24 V DC
- 🕒 100,000 h
- 💧 IP66
- ☀️ 130 lm/W
15,600 lm
- 📖 7.4 kg



PREMIUM

- 5,700 K
- ⚡ 100-277 V ~
- ⚡ 12-24 V DC
- 🕒 100,000 h
- 💧 IP66
- ☀️ 160 lm/W
19,200 lm
- 📖 7.4 kg



EG-LHD-150W



ESTÁNDAR

- 5,700 K
- ⚡ 100-277 V ~
- ⚡ 12-24 V DC
- 🕒 100,000 h
- 💧 IP66
- ☀️ 130 lm/W
19,500 lm
- 📖 7.6 kg



PREMIUM

- 5,700 K
- ⚡ 100-277 V ~
- ⚡ 12-24 V DC
- 🕒 100,000 h
- 💧 IP66
- ☀️ 160 lm/W
24,000 lm
- 📖 7.6 kg



CUERPO
ALUMINIO PURO



PAESE
Programa de Ahorro de Energía
del Sector Eléctrico

*Solo la serie LHD PREMIUM cuenta con el certificado PAESE



FOTOVOLTAICO

FOTOVOLTAICO

FOTOVOLTAICO

FOTOVOLTAICO

FOTOVOLTAICO

FOTOVOLTAICO

FOTOVOLTAICO

FOTOVOLTAICO

FOTOVOLTAICO

FOTOVOLTAICO

FOTOVOLTAICO



5 Razones para implementar un Sistema Fotovoltaico

01

Si pagas \$ 2, 500 de luz o más e instalas un sistema fotovoltaico verás un ahorro de hasta el 100 % de tu consumo de energía eléctrica.

02

Verás tu retorno de inversión en muy poco tiempo al reducir o eliminar tu consumo a CFE.

03

Los paneles solares tienen una garantía de hasta 25 años y el mantenimiento es prácticamente nulo.

04

Sistema único que permite un suministro de energía renovable, incluso en días nublados.

05

La implementación es muy sencilla y nosotros contamos con asesores certificados que te ayudarán paso a paso en tu proyecto.

FOTOVOLTAICOS

SISTEMAS FOTOVOLTAICOS



En Energain nos ocupamos de promover un menor consumo de energía eléctrica con nuestros productos y a su vez, cuidar al medio ambiente generando la energía que usamos en nuestra casa, negocio o industria. Nuestro mejor aliado para lograrlo es el Sol, pues lo usamos como un medio de generación de energía eléctrica limpia e inagotable.

Con nuestra experiencia, te ofrecemos soluciones pensadas y diseñadas a tu medida. Contamos con personal calificado para desarrollar este tipo de instalaciones cumpliendo con las normas requeridas y equipo especializado para satisfacer tus necesidades.

De esta manera lograremos un menor consumo energético sin generar impacto ambiental.

FUNCIONAMIENTO DEL SISTEMA

El sistema solar **ENERGAIN** convierte la energía solar en electricidad, lista para usarse en la instalación eléctrica existente de comercios e industrias. La energía solar generada que no se usa al momento se envía a la red eléctrica y cuenta a favor del negocio.

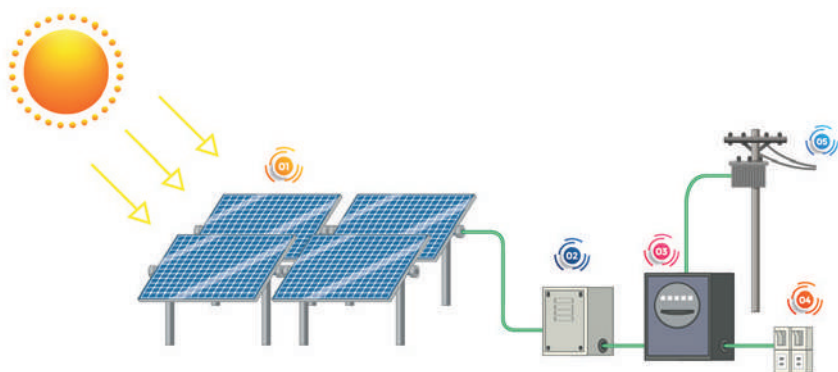

01 **PANELES** Transforman la irradiación del sol en energía eléctrica.

02 **INVERSOR** convierte la energía que se genera en cada panel para ser empleada en tu inmueble.

03 **MEDIDOR BIDIRECCIONAL** Mide la energía que consumes y la energía que generarás a la red eléctrica.

04 **CONSUMO**

05 **RED CFE**

Envíanos una foto de tu recibo de CFE a: solar@energain.com.mx y analizamos tu consumo y te ofrecemos una solución a tu medida.

SISTEMAS FOTOVOLTAICOS

Con nuestra experiencia, desarrollamos proyectos llave en mano con soluciones diseñadas a las necesidades del cliente, buscando promover un mejor uso de la energía implementando medios de generación renovables, alineados con nuestro objetivo de ser una empresa sustentable.

Ofrecemos soluciones en:

Residencial



Desarrolla el sistema ideal para ti de acuerdo a tus consumos, identificando, por medio de tu recibo de luz, la mejor manera de producir tu propia energía y pagando menos a CFE.

Comercial

La solución según las necesidades de cada empresa de baja y mediana tensión. Tenemos la respuesta ya sea en sistemas interconectados o aislados, de cualquier escala.



INDUSTRIAL

Especialistas en proyectos llave en mano de acuerdo a las necesidades de la industria. Contamos con el personal y la capacidad de poder desarrollar proyectos en mediana y gran escala, en relación al consumo, la maquinaria y especificaciones del rubro industrial.

SISTEMAS FOTOVOLTAICOS



LUMINARIAS AUTÓNOMAS SOLARES

MODELOS:

EG-AIO-30W
EG-AIO-40W
EG-AIO-50W
EG-AIO-60W
EG-AIO-80W
EG-AIO-100W

**NUEVO
MODELO**

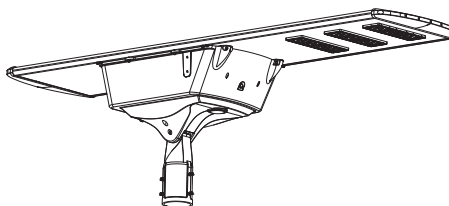
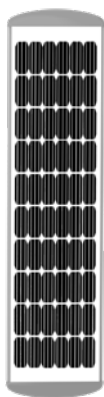
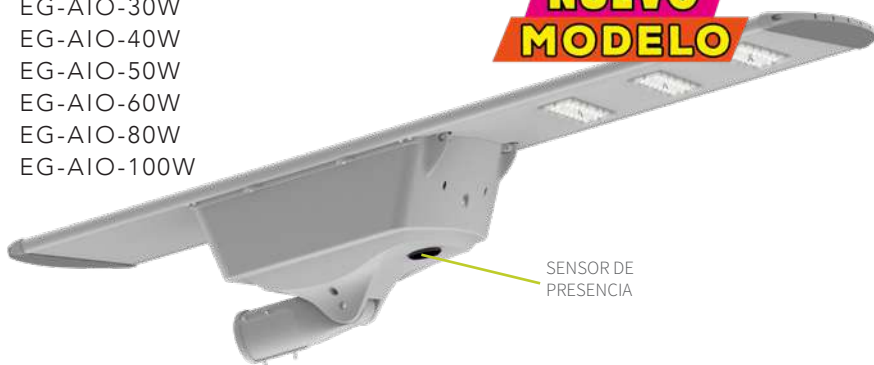

30W

40W

50W

60W

80W

100W

5,700 K



12 V



6 h



2-3 dias



IP66



200 lm/W



5,700 K



12 V



6 h



2-3 dias



IP66



200 lm/W



5,700 K



24 V



6 h



2-3 dias



IP66



200 lm/W



5,700 K



24 V



6 h



2-3 dias



IP66



200 lm/W



5,700 K



24 V



6 h



2-3 dias



IP66



200 lm/W



5,700 K



24 V



6 h



2-3 dias



IP66



200 lm/W



PREGUNTA POR LOS TIEMPOS DE ENTREGA.

SUBURBANA

SUBURBANA

SUBURBANA

SUBURBANA

SUBURBANA

SUBURBANA

SUBURBANA

SUBURBANA

SUBURBANA

SUBURBANA

SUBURBANA



REFLECTORES CAMPOS URBANOS

EG-TURM-35W



FOTOCELDA
INCLUIDA

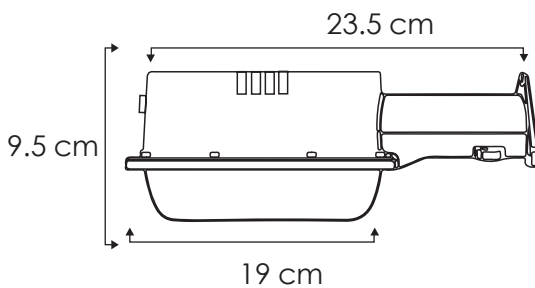

35W

5,000 K

100-277 V~

50,000 h

120°

IP65

3,500 lm

860 g

Cubierta
OPAL



PUNTA DE POSTE CAMPOS URBANOS

Opciones de modelos

EG-ST20



**NUEVO
MODELO**

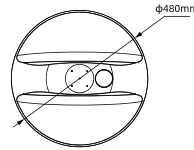
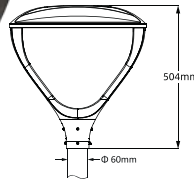

EG-ST20-A



EG-ST20-B



EG-ST20-C



60W

80W

100W

120W

150W

5,700 K
5,000 K
4,000 K
3,000 K

5,700 K
5,000 K
4,000 K
3,000 K

5,700 K
5,000 K
4,000 K
3,000 K

5,700 K
5,000 K
4,000 K
3,000 K

5,700 K
5,000 K
4,000 K
3,000 K

100-277 V ~
100-240 V ~
50,000 h
75°

100-277 V ~
100-240 V ~
50,000 h
75°

100-277 V ~
100-240 V ~
50,000 h
75°

100-277 V ~
100-240 V ~
50,000 h
75°

100-277 V ~
100-240 V ~
50,000 h
75°

IP66
130 lm/W
7,800 lm

IP66
130 lm/W
10,400 lm

IP66
130 lm/W
13,000 lm

IP66
130 lm/W
15,600 lm

IP66
130 lm/W
19,500 lm



Pregunta por los tiempos de entrega.

*Versión B y C sobre pedido.

PUNTA DE POSTE
CAMPOS URBANOS

EG-PP-ESTOCOLMO



**NUEVO
MODELO**

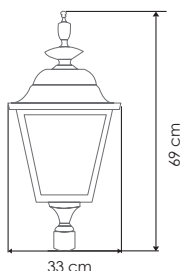

55W

- 6,000 K
- 5,000 K
- 4,000 K

220 V~

IP65

7,150 lm

7 kg



CUERPO
ALUMINIO

EG-PP-BERLÍN



**NUEVO
MODELO**

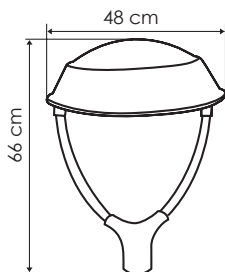

55W

- 6,000 K
- 5,000 K
- 4,000 K

220 V~

IP65

7,150 lm

7 kg



CUERPO
ALUMINIO

*Pregunta por los tiempos de entrega

PUNTA DE POSTE CAMPOS URBANOS

EG-POSTE-VELA

40W

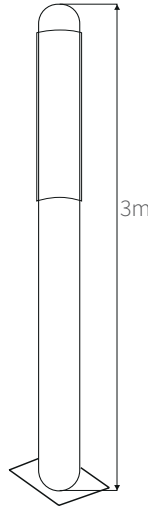

- 6,000 K
- 220 V ~
- IP65
- 7,750 lm
- 7 kg

Disponible Altura
2.60 m
3.00m

CUERPO

ACERO Y
POLICARBONATO
Metodo de sujeción:
Patín redondo ó cua-
drado.

EG-POSTE-POL

40W

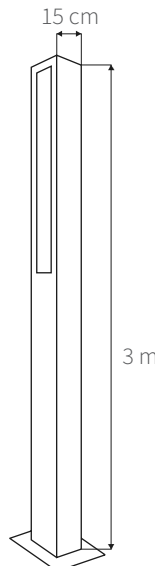

- 6,500 K
- 110-220 V ~
- IP65
- 7 kg

DISPONIBLE ALTURA:
2,00 mts
3,00 mts

CUERPO

ACERO Y
ACRÍLICO FROST
Metodo de sujeción:
Anclado a concreto.

*Pregunta por los tiempos de entrega

ACCESORIOS

ACCESORIOS

ACCESORIOS

ACCESORIOS

ACC

A

ACCESORIOS

ACCESORIOS

ACCESORIOS

ACCESORIOS



EG-BP-T8-G13

Base G13 para lámparas T8

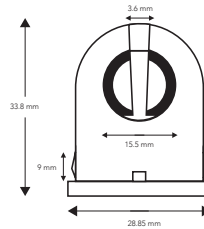

Fuente remota de poder para luminaria tipo panel.

- EG-DPP-3W
- EG-DPP-6W
- EG-DPP-9W
- EG-DPP-12W
- EG-DPP-18W
- EG-DPP-24W

⚡ 100-240 V AC
 💧 IP40



FAMILIA
LEP



Fuente remota de poder ATENUABLE a fase 127V para luminaria tipo panel.

- EG-DPPA-9W
- EG-DPPA-12W
- EG-DPPA-18W
- EG-DPPA-38W



⚡ 90-135 V AC
 💧 IP40

FUENTE DE PODER

EG-FPWP

Fuente de poder para bañador.



150W 240W

⚡ 24 V DC ⚡ 24 V DC
💧 IP65 💧 IP65

Compatible con bañadores de pared RGB 24V DC IP66

EG-FP-100W-12V

Fuente de poder para tira de 12V y EG-LPA56-20W

100W

⚡ 100 - 240 V AC
a 12 V DC
💧 IP20



Fuente de poder 24V

Instalación en interior

EG-FP-150W-24V 150W

EG-FP-240W-24V 200W

⚡ 100 - 240 V AC
a 24 V DC
💧 IP20



FUENTE DE PODER

EG-FP-24W

Fuente de poder de 24W para tira LED de 12V y EG-LPA56-20W



24W

⚡ 100-240 V

💧 IP20

Compatible con tiras LED 12 V

EG-FP-48W

Fuente de poder de 48W para tira LED de 12V y EG-LPA56-20W

48W

⚡ Entrada: 100-240 V ca Salida: 12 V dc 💧 IP20

Compatible con tiras LED 12 V



ACCESORIOS PARA LUMINARIAS EMPOTRABLES DE CORTESÍA EXTERIOR



Compatibles con los modelos:

EG-F102A-SET

EG-B106A-SET

💧 IP65

EG-TRACK-1M

Riel para luminaria de acentos Tracklight Disponible en color blanco y negro.



Compatible con los modelos:

EG-TLS-18W

EG-TLS-20W

EG-TLS-35W



CONECTORES TRACK LIGHT

Conector para unir rieles monofásicos
para luminarias Track Light .

EG-TRACK-CON



Disponible en color
blanco y negro

EG-TRACK-CON-L



EG-TRACK-CON-T



EG-TRACK-CON-X



ARILLOS PARA TRACK LIGHT

EG-TLS-G1



EG-TLS-B1



EG-TLS-N1



EG-TLS-S1



*Para modelos:
EG-TLS-MR7W
EG-TLS-MS7W



BALASTRO DE EMERGENCIA

EG-BE40W-2HRS

3-40W

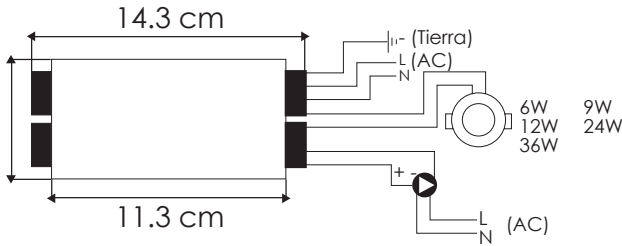

Balastro de Emergencia

⚡ 85-265 V-

💧 IP50

Compatible con Serie LEP
y panel 36W y 40W

TIEMPO DE
RESPALDO
2 HRS.



AMPLIFICADOR

EG-AP-RGB

Amplificador

Para Bañador de Pared RGB 24V



150W

⚡ 12/24 V DC

💧 IP68

CONTROLADOR RGB

EG-CRGB-E

Controlador y control remoto RGB

Para Tira LED de 12V-RGB de 5 m económico.



⚡ 12 V DC

💧 IP20



CONTROLADORES

EG-CRGB-DMX Amplificador

⚡ 12 V cd
⚖ 465 g



Entrada de señal DMX	1CH DMX (485)
Señal de salida DMX	3CH DMX (485)
Socket DMX512	XLR de 3 pines, termina verde

Amplificador DMX
para luminario LED tipo bañador y tira.

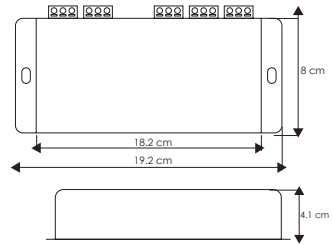

EG-CRGB-DMX Decodificador

Decodificador DMX
para luminario LED tipo bañador y tira.



⚡ 12-24 V cd
⚖ 420 g

Interfaz DMX	3-Pines XLR RJ45
Señal de entrada	DMX512 RDM

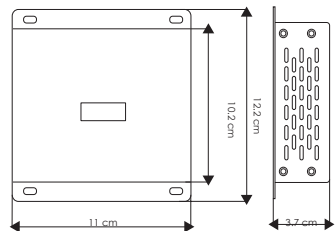

DMX

EG-CMH-24VDC

Conector para controlador EG-CRGB-DMX

5 pines; macho y hembra para alimentación de bañador DMX

17 cm de largo

24 DVC

IP65



EG-EX1M

Extensión de 1m de largo

Para interconectar bañador DMX

-5 pines

-24 DVC

EG-EX2M

Extensión de 1m de largo

Para interconectar bañador DMX

-5 pines

-24 DVC



Estos accesorios son compatible para: EG-BP-BEAM, EG-BP-BD y EG-XL080

CONTROLADORES

EG-CRGB-DMX Controlador Master

3W



⚡ 100-240 V CA

⚖ 806 g

💧 IP20

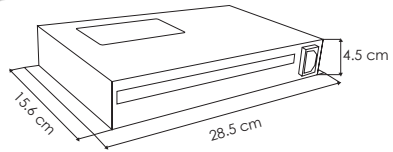

Controlador Master DMX

para luminario LED tipo bañador y tira.

Para uso de EG-YS305D, EG-BEAM, EG-BP-BD, TIRA LED, EG-BP-XL080, EG-BP-XL100, EG-BP-XL180



EG-CON-WIFI-DMX Controlador

💧 IP20

Descarga la APP

Requiere fuente de poder 12 o 24 V



CONTROLADOR BAÑADORES DE PARED

EG-CON-01C

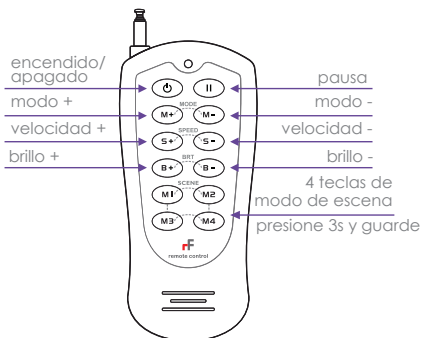

- ⚡ 12/24 V~
- 💧 IP20
- ⚖️ 210 g
- 🕒 35 000 h

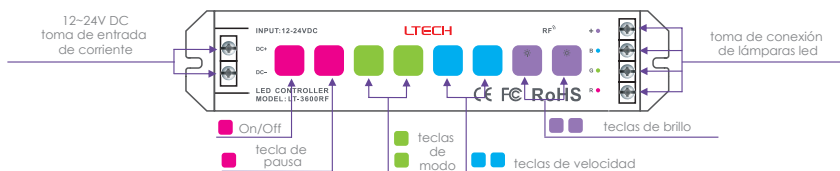

Niveles de Brillo	20	Interface	Touch
Niveles de Velocidad	20	Distancia de control	>30m (sin barrera)
Canal de salida	3: RGB	Corriente de salida (Max)	6 A por canal

Compatible con:
-EG-XL024-D3-RGB
-EG-XL-048-D3-RGB
-EG-RW-500-RGB
-EG-LPA56-RGB
-EG-LPF-RGB



CONTROLADORES

CONTROLADOR PARA LUMINARIAS AUTÓNOMAS EG-CS20



⚡ 12/24 V ~

💧 IP68

⚖️ 300 g

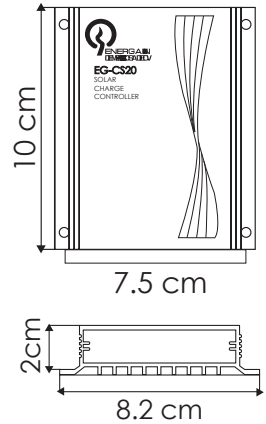

CONTROLADOR RGB PARA TIRA LED

EG-CRGB-127V



⚡ 127 V

💧 IP65



Controlador RGB para Tira LED

EG-TL-5050-60LED's 127V

Compatible con tiras LED DE
127V de 25m

ACCESORIOS PARA TIRAS LED

CONECTORES PARA TIRAS LED 12V



IP20

Para tiras 3528 y tiras 5050

Modelo

EG-ST3-3528
EG-ST3-5050
EG-STSL-3528
EG-STSL-5050
EG-SC-5050
EG-SC-3528
EG-STSL-5050 RGB
EG-SC-5050 RGB

ACCESORIOS PARA TIRA LED DE 127V

- Convertidor
- Conector corto
- End cap
- Clip en "U"
- Cubierta para protección final

Modelo

1	EG-SC-5050-127VAC_IP65
2	EG-STSD-5050-127V
3	EG-ST3-5050
4	EG-CLU-5050-127V
5	EG-ENDCAP-5050-127V_IP65

Modelos RGB

EG-ST3-5050-127V-RGB
EG-STSD-5050-127V-RGB
EG-STSDL-5050-127V-RGB



ACCESORIOS PARA TIRA MESH

**Controlador para tira
de LED inteligente**
modelo
EG-TL-5050-MESH



ACCESORIOS PARA TIRAS LED

Conector corto de tira a tira para
modelo EG-TL-5050-MESH

EG-STSC-MESH



EG-STWC-MESH



Conector largo de tira a controlador para
modelo EG-TL-5050-MESH

EG-STCL-MESH



ACCESORIOS PARA TIRAS LED SCOB-5M

EG-SCOBSC

Conector largo para conectar tira scob
monocromaticos de 24 V cd.



EG-SCOB-STS

Conector corto para unir tiras
SCOB cortadas monocromaticas
a 24V cd.



EG-FP-SCOB

Fuente de poder tira Led
SCOB-72W-24V dc.



ACCESORIOS

EG-SCOB-STSL

Conector largo de dos puntas para unir tiras SCOB cortadas monocromaticas a 24 V cd.



EG-PDL-CON-L



Accesorios para
conectar luminaria
colgante modelo
EG-PDL-4000

EG-PDL-CON-T



EG-PDL-CON-X



ACCESORIOS

ACCESORIOS PARA EG-TL-SCOB-50W

EG-SCOB-SC-127V

CONVERTIDOR



EG-SCOB-STS-127V

CONECTOR PARA TIRA LED



EG-SCOB-ENDCAP-127V

End cap



EG-SCOB-CLU-127V

CLIP EN "U"



ACCESORIOS

EG-FC

BASE PARA FOTOCELDA



EG-LHD-BDR

Braço de alumínio dirigível para luminaria vial

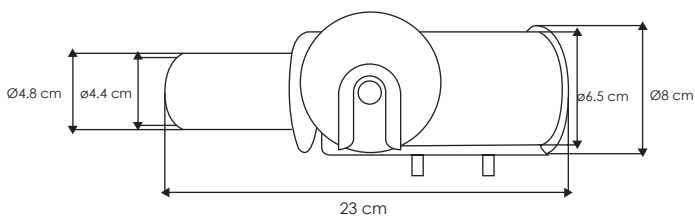

EG-BR-UFO

Soporte para sobreponer UFO



PARA PANEL 30X30, 30X120, 60X120

ACCESORIOS

EG-CP-CPL

Cable de acero para suspender
Panel Light Juego de 4 piezas



PARA PDL-4000

ACCESORIOS

EG-ACPDL-4000

Accesorio para interconectar luminaria
colgante modelo EG-PDL-4000



EG-ACPDL-4000

Incluyen tornillería
para su instalación.



EG-PDL4000-EP

Accesorios para
sobreponer luminaria
colgante modelo
EG-PDL-4000





Comedor



Se recomienda ponerlas a una **altura de 75 cm** desde la superficie de la mesa.



Barras



Al igual que la mesa, esta es ideal colocarla a **75cm de la barra** pues no lastima la vista y es buena para su decoración.



Islas o Mesadas



Esta se recomienda colocarlas a una **altura de la superficie de 180 cm**.

ALTIMURA IDEAL PARA LÁMPARAS COLGANTES

GLOSARIO

Color: El color es relativo y depende de la composición espectral de la iluminación existente, los colores logran cambiar la apreciación del espacio y sensación de confort, afectando física y psicológicamente a las personas.

CRI: (Color Rendering Index / índice de reproducción cromática-IRC). Mide la capacidad que una fuente luminosa tiene para reproducir fielmente los colores de varios objetos en comparación con una fuente de luz natural o ideal.

Eficiencia luminosa: Relación existente entre el flujo luminoso (medido en lúmenes) emitido por una fuente de luz y la potencia consumida (medido en watts). Se da como el cociente entre los dos parámetros y su unidad de medida es el lumen por watt (lm/W).

Lámpara: Estas fuentes de iluminación cuentan con una base, conductor eléctrico, que al hacer contacto con su soporte, generan la energía lumínica. Dentro de esta categoría encontramos las llamadas lámparas lineales, dicroicos y bombillas.

LED: (Light-Emitting Diode / diodo emisor de luz): Los LEDS presentan muchas ventajas sobre las fuentes de luz incandescentes y fluorescentes, principalmente por el bajo consumo de energía, mayor tiempo de vida, tamaño reducido, durabilidad, resistencia a las vibraciones, mínima emisión de calor y por el hecho de que no contienen mercurio y no crean campos magnéticos altos.

Luminario(a): es el aparato que sirve para generar energía lumínica, sin usar una base, a diferencia de las lámparas, las luminarias van conectadas directamente a la corriente por medio de cables.

TCC: Temperatura de color correlacionada.

Temperatura de color: Se mide en grados Kelvin (°K), es una forma de comparar la blancura de la luz emitida. A baja temperatura de color (típicamente 3000° K) corresponde un color cálido. Mientras más alta sea la temperatura de color, la luz parece más fría. El blanco frío usualmente tiene una temperatura de color cercana a los 6000° K.

Bases de Lámparas

E12



E14



E26/E27



E39/E40



G4



G9



G5



G13



Fa8



GU5.3



GU10



G23



G24



G53



CUADRO COMPARATIVO

MENOS EFICIENTE

MÁS EFICIENTE

BRILLO

TIPO DE BOMBILLA			
LÚMENES	INCANDESCENTES Y HALÓGENOS	FLUORESCENTES	LED
100 - 200	20 W	6 W	2 W
200 - 300	35 W	8 W	3 W
350 - 500	40 W	11 W	5 W
450 - 600	50 W	13 W	6 W
600 - 700	60 W	15 W	7 W
700 - 900	70 W	18 W	9 W
800-1000	80 W	20 W	10 W
900 - 1200	100 W	25 W	12 W
1000 - 1300	110 W	30 W	13 W
1200 - 1500	130 W	40 W	15 W
1400 - 1800	140 W	50 W	18 W
1600 - 2000	150 W	60 W	20 W
2100 - 2500	200 W	70 W	25 W
2500 - 3000	250 W	80 W	30 W
3500 - 5000	400 W	100 W	50 W
6000 - 8000	600 W	150 W	80 W
9000-10000	750 W	200 W	100 W
10500-12000	850 W	250 W	120 W
13000-15000	1000 W	300 W	150 W
18000-20000	1500 W	400 W	200 W
AHORRO ENERGÉTICO	0%	50%	+80%
VIDA ÚTIL	1 a 3 años	4 a 6 años	7 a 15 años

*Valores Aproximados

CONSUMO DE ENERGÍA



ÁNGULO DE APERTURA

La apertura de los rayos de luz es el ángulo de esta que crea una fuente de luz cuando alcanza una determinada superficie. Se expresa en grados y puede variar desde los 15° hasta los 120° según el tipo de luminaria o foco.

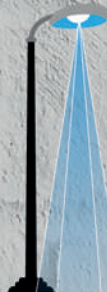

15°-30°

Luces de acento que se utilizan para resaltar objetos concretos.

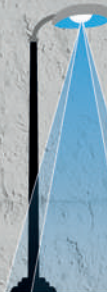

35°-55°

Ilumina zonas puntuales, concentrando la intensidad luminosa en esa área.



60°-110°

ilumina superficies amplias y reduce sombras.



120°

Luz general donde su función es disipar las sombras e iluminar el mayor área posible.

GENERAL

Aporta visibilidad básica a un lugar y son lámparas de techo que aportan la luz principal de la casa.



AMBIENTAL

Son luces tenues que ayudan a crear un ambiente en la habitación cuando las demás están apagadas.



PUNTUAL

Esta iluminación es más intensa y se utiliza para iluminar lugares concretos.



DECORATIVA

Esta solo se enfoca a iluminar objetos en específico.



TIPO DE ILUMINACIÓN









Primer índice
Totalmente protegido
contra el polvo.
Estanca al polvo.











Segundo índice
Protegido contra el
agua a chorro desde
cualquier ángulo.

Grado de protección contra la introducción de cuerpos sólidos

Primer índice	Descripción	Símbolo	Alcance de la protección
0	Sin protección.		Sin especial protección para personas contra un contacto directo de piezas móviles internas y las externas con vida. Sin protección a los equipamientos contra el ingreso de objetos sólidos externos.
1	Protección contra los cuerpos sólidos grandes.		Protección contra el contacto accidental de grandes áreas con vida y partes interiores con movimiento, por ejemplo: la parte posterior de la mano. Pero sin protección contra el acceso deliberado del mismo. Protección contra el ingreso de objetos sólidos con un diámetro mayor que 50 mm.
2	Protección contra los cuerpos sólidos medianos.		Protección contra el contacto entre los dedos y las partes interiores móviles. Protección contra el ingreso de objetos sólidos con un diámetro mayor a 12,5mm.
3	Protección contra los cuerpos sólidos pequeños.		Protección contra el contacto entre las piezas móviles internas y herramientas, cables, hilos etc con un espesor mayor a 2,5mm. Protección contra el ingreso de objetos sólidos con un diámetro mayor a 2,5 mm.
4	Protección contra los cuerpos sólidos muy pequeños (granulados).		Protección contra el contacto entre las piezas móviles interiores y herramientas, cables, hilos etc con un espesor mayor a 1mm. Protección contra el ingreso de objetos sólidos con un diámetro mayor a 1mm.
5	Protección contra los residuos de polvo.		Protección contra el contacto entre las piezas móviles interiores y el ingreso de polvo. El ingreso no se previene completamente, pero el polvo no puede penetrar en tales cantidades que puedan afectar al funcionamiento correcto del mismo.
6	Protección total contra la penetración de cualquier cuerpo sólido (estanqueidad)		Protección total contra el contacto de las piezas móviles interiores. Protección contra cualquier ingreso de polvo.

¿QUÉ ES EL ÍNDICE DE PROTECCIÓN?

Grado de protección al agua

Segundo Índice	Descripción	Símbolo	Alcance de la protección
0	Sin protección.		Sin ninguna protección especial
1	Protección contra el goteo de agua vertical (condensación)		La caída vertical de gotas de agua no debe causar daños.
2	Protección contra el goteo de agua inclinada verticalmente.		La caída de gotas de agua con hasta un ángulo de 15° de la vertical desde cualquier dirección, no debe causar daño.
3	Protección contra agua en spray.		La caída de gotas de agua con hasta un ángulo de 60° de la vertical desde cualquier dirección, no debe causar daño (lluvia).
4	Protección contra las salpicaduras de agua.		Las salpicaduras de agua desde cualquier dirección, no deben de causar daños al interior.
5	Protección contra chorros de agua de cualquier dirección con manguera.		Los chorros de agua producidos con manguera y desde cualquier dirección, no deben de causar daño al interior.
6	Protección contra inundaciones.		La cantidad de agua que se introduzca, en casos de inundación esporádica o temporal, no debe dañar el interior, por ejemplo, los golpes de mar.
7	Protección contra la inmersión temporal.		La cantidad de agua que se introduzca, en caso de sumergir el equipamiento en específicas condiciones de presión entre 1 y 30 minutos, no debe dañar las piezas internas del mismo.
8	Protección durante inmersión continua.		Sumergimos el equipamiento al menos con 2 horas y con una presión de 2 bares (para los racores HelaGuard IP68 No estándar) y de 5 horas y con una presión de 5 bares (para los racores HelaGuard IP68 Metálicos), no deben producir daño en el interior.



SI NECESITAS ASESORÍA PROFESIONAL
NOSOTROS TE APOYAMOS EN TU PROCESO.

Teléfonos:

•PUEBLA 222 5737 000

•CDMX 555 5104 172

•MONTERREY 811 3540 388

•CANCÚN 998 8863 195

•QUERÉTARO 442 5436 643

•MÉRIDA 999 4299 486

•GUADALAJARA 333 6524 553

Mail: contacto@energain.com.mx

cotizacion@energain.com.mx



CONTAMOS CON
MÁS DE

300

DISTRIBUIDORES A
NIVEL NACIONAL



COBERTURA

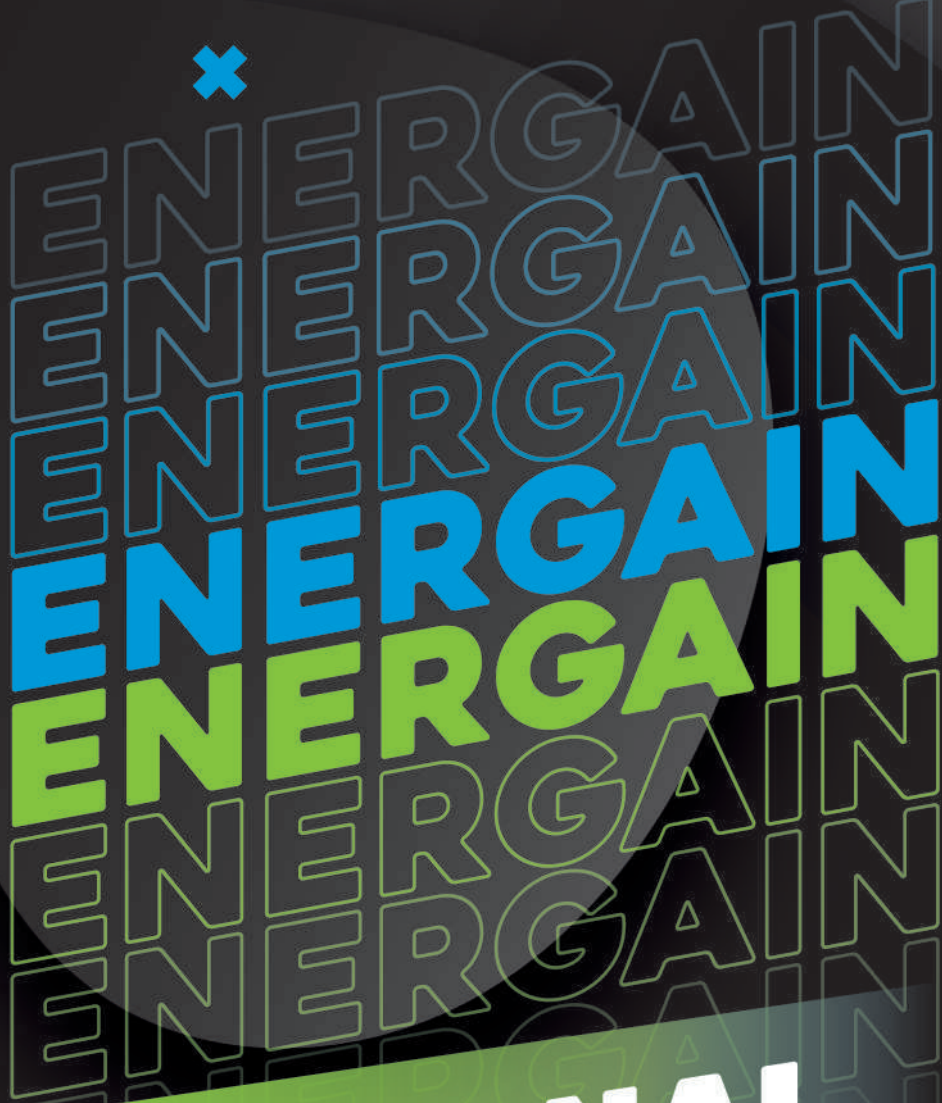

NACIONAL

CATÁLOGO 2024, PRIMERA EDICIÓN, FEBRERO 2024
Es propiedad intelectual de ENERGAIN DE MÉXICO S.A. DE C.V.

El contenido de este documento, las especificaciones de los productos y las imágenes que aquí se representan son completamente ilustrativas. Y están sujetos a cambios sin previo aviso.



La documentación y los productos aquí descritos han sido revisados exhaustivamente. Si localiza alguna falta tipográfica u otro tipo de error le agradecemos que nos informe del mismo a : marketing@energain.com.mx



ENERGAIN DE MÉXICO S.A. DE C.V.
Carretera Federal México - Puebla.
Número exterior: Km. 126.5
Número interior: Local 2.
Colonia: Ignacio Romero Vargas.
Heróica Puebla de Zaragoza, Puebla.
C. P. 72120.



www.energain.com.mx

