



SPACE

Automatic Pet Feeder

@Libro Corp. All Rights Reserved.

Model: PLAF107

Manufacturer: Shenzhen Libro Technology Co., Ltd.

Address: 12/F, Tower B, GALAXY WORLD, Yabao Road,
Longgang District, Shenzhen, China

JP Importer: 株式会社神州

Made in China

PLAF107_V1.0

FCC ID: 2A3DE-PLAF107

IC ID: 28987-PLAF107



This device complies with Part 15 of the FCC Rules. Operation is subject to the following two conditions: (1) this device may not cause harmful interference, and (2) this device must accept any interference received, including interference that may cause undesired operation.

USER MANUAL

Space Automatic Pet Feeder

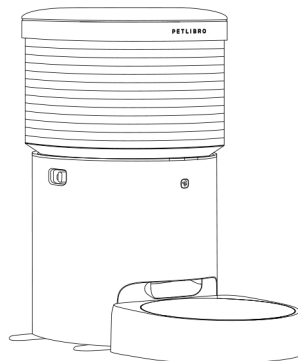

Please read this manual before using the product and keep it for future reference. Or open the PETLIBRO app and go to DEVICE SETTINGS > Instructions for the digital manual and instructional video.

CONTENTS

English

01 – IN THE BOX

02 – PRODUCT OVERVIEW

06 – GETTING STARTED

10 – APP CONTROL

11 – SPECIFICATIONS

12 – SAFETY INSTRUCTIONS

13 – WARRANTY

13 – NOTICE

IN THE BOX

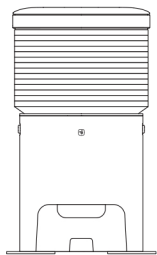

Automatic Pet Feeder

X1



User Manual

X1



Stainless Steel Bowl

X1



Power Cable

X1



Bowl Tray

X1



Power Adapter

X1

PRODUCT OVERVIEW

1. Lid Release Button
2. Lid
3. Silicone Strip
4. Food Tank
5. Vane
6. Rotor
7. Rotor Cover
8. Status Indicator
9. Food Tank Lock Switch
10. Air Pumping Button
11. Body
12. Stainless Steel Bowl
13. Bowl Tray

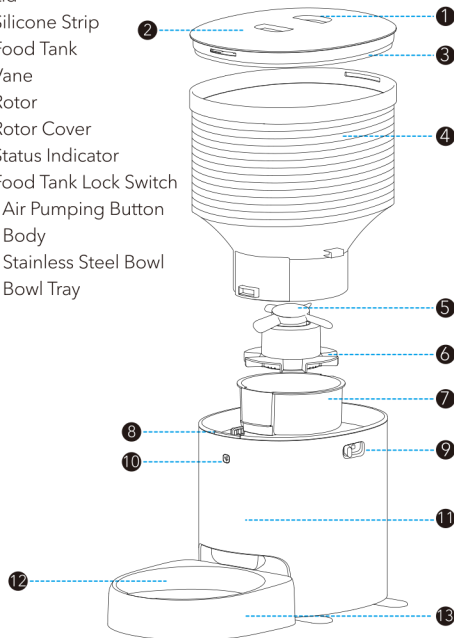

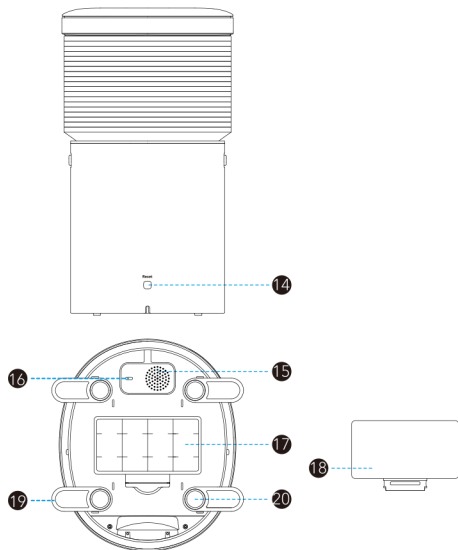



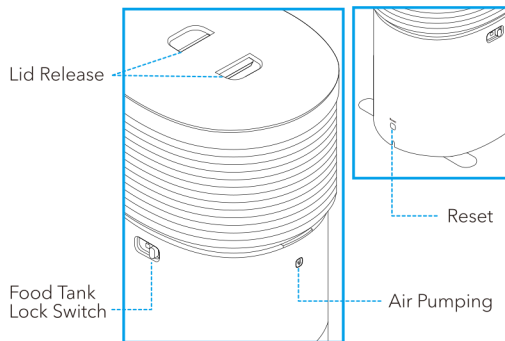

- 14. Reset Button
- 15. Speaker
- 16. Power Port
- 17. Battery Compartment
- 18. Battery Compartment Cover
- 19. Foot
- 20. Non-slip Pad

Buttons



Buttons	Operation
 Reset	Press and hold for five seconds, and the feeder will automatically reset
 Air Pumping	Short-press to pump air out of the food tank
 Lid Release	Push the blue parts of the button towards the center of the lid to open it
 Food Tank Lock	Toggle the lock switch to remove or lock the food tank in place

Indicator Status

Indicator Status	Device Status
Flashes white once every second	Waiting for network configuration
Flashes white once every half a second	Network configuration mode
	Firmware update
Breathing white	The feeder is pumping air out of the tank
White on	Wi-Fi is connected
Flashes red and white once every half a second	The feeder is not connected
Red on	Food has not been dispensed on a set schedule
	Failed to pump out air
	The food outlet is blocked
	Food levels are low
	Low battery
	Battery power only
Off	The feeder is powered off

GETTING STARTED

Installation

1. Push the   button and remove the lid.

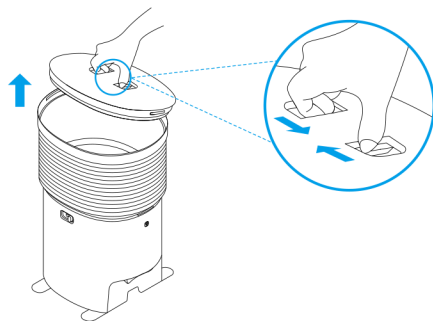

2. Add dry pet food to the food tank.

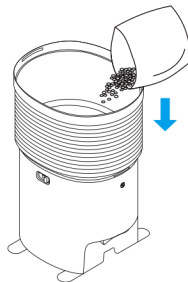

3. Replace the lid and push the  button to make sure the lid is securely locked.

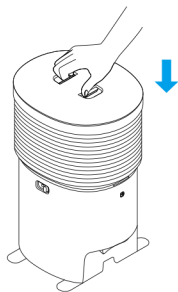

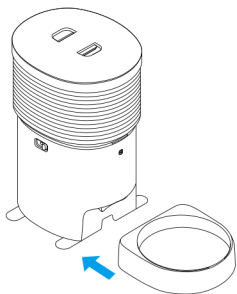

4. Install the stainless steel bowl and bowl tray.

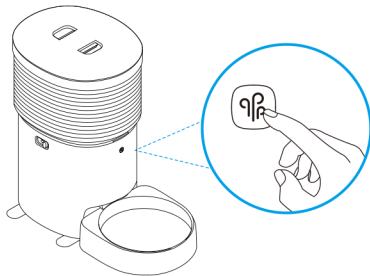

5. Press the  button to pump air out of the tank.



Notes

- If the lid is not securely locked, the feeder can't successfully pump air out of the tank. Please make sure the two "LOCKED" markings on the  button are clearly seen without being blocked after installing the lid. If the markings are blocked, manually push the button again.
- Add dry pet food before pressing the  button.
- After the air in the food tank is pumped out, if you don't push the  button first, you can't open the lid.

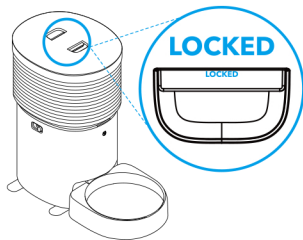

Note

- Scan the QR code above to watch the video for product installation and cleaning.

Power on

Install four D alkaline batteries into the battery compartment. And connect the feeder to a wall outlet with the power adapter and power cable.

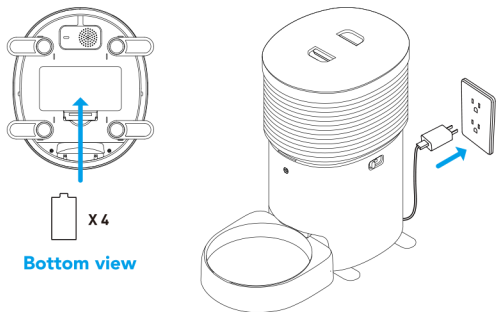

Bottom view

Power off

Unplug the cable from the outlet and remove the batteries.

Battery Power Mode

In the event of a power outage, the feeder will automatically switch to the Battery Power Mode. To ensure that the feeder can still dispense food on schedule, it's strongly recommended to install backup batteries.

Important Note

- Please ensure that the feeder is always plugged into a wall outlet for power. In the event of a power outage, the PETLIBRO app will notify you. In Battery Power Mode, the feeder has a battery life of over 3 days, but the Air Pumping function cannot be used, and the food level detection function is only enabled during feeding.

APP CONTROL

1. Scan the QR code or search in your device's app store to download and install the PETLIBRO app.



2. Follow the instructions to configure the network.

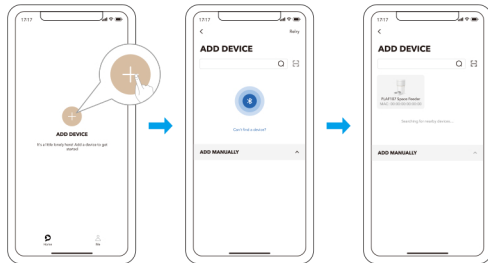

SPECIFICATIONS

Model	PLAF107
Per Portion	1/12 cup
Power Adapter	Input: AC 100-240V 50/60Hz Output: DC 5V 2A
Food Tank Capacity	8L
Stainless Steel Bowl Capacity	1200ml / 41oz
Wireless Frequency	2.4GHz, 5GHz
Supported System	Android, iOS
Material	ABS, stainless steel
Dimensions	452 × 429 × 249mm / 17.8 × 16.9 × 9.8in
Weight	4.3kg / 9.4lb

SAFETY INSTRUCTIONS

- Use the feeder in a dry place.
- Use the feeder on a level surface.
- Dispose of all packaging materials properly. Some items may be packed in plastic bags; these bags could cause suffocation. Keep them away from children and pets.
- Do not use the feeder with pets that are not able to reach the food bowl or with any physical disability.
- Do not immerse the base part in water at any time as it may damage electronic components.
- Do not use the feeder outdoors. Check its operation frequently to be sure it is operating properly.
- Do not disassemble the feeder other than as instructed in this user manual.
- Only use accessories recommended or sold by the manufacturer. The use of accessories not recommended or sold by the manufacturer may cause an unsafe condition.
- Do not modify the feeder.
- Examine the feeder after installation. Do not plug in if there is water on the power cable or plug.
- To avoid tripping, always position the power cable out of the way of foot traffic.
- Do not install or store the feeder where it will be exposed to weather or temperatures below 0°C (32°F).
- Do not use the feeder without adding pet food first.
- Power off the feeder when it's not in use.

WARRANTY

- 12-month warranty
- For guidance on product use, please contact our customer service team via email:

support@petlibro.com.

NOTICE

FCC statement

This device complies with Part 15 of the FCC Rules. Operation is subject to the following two conditions:

- (1) this device may not cause harmful interference, and
- (2) this device must accept any interference received, including interference that may cause undesired operation.

Changes or modifications to this unit not expressly approved by the party responsible for compliance could void the user's authority to operate the equipment.

NOTE:

This equipment has been tested and found to comply with the limits for a Class B digital device, pursuant to Part 15 of the FCC Rules. These limits are designed to provide reasonable protection against harmful interference in a residential installation. This equipment generates, uses and can radiate radio frequency energy and, if not installed and used in accordance with the instructions, may cause harmful interference to radio communications. However, there is no guarantee that interference will not

occur in a particular installation. If this equipment does cause harmful interference to radio or television reception, which can be determined by turning the equipment off and on, the user is encouraged to try to correct the interference by one or more of the following measures:

- Reorient or relocate the receiving antenna.
- Increase the separation between the equipment and receiver.
- Connect the equipment into an outlet on a circuit different from that to which the receiver is connected.
- Consult the dealer or an experienced radio/TV technician for help.

This device and its antenna(s) must not be co-located or operated in conjunction with any other antenna or transmitter.

Radio frequency exposure statement

To maintain compliance with the FCC's RF Exposure Guidelines, this equipment should be installed and operated with a minimum distance of 20cm from your body.