

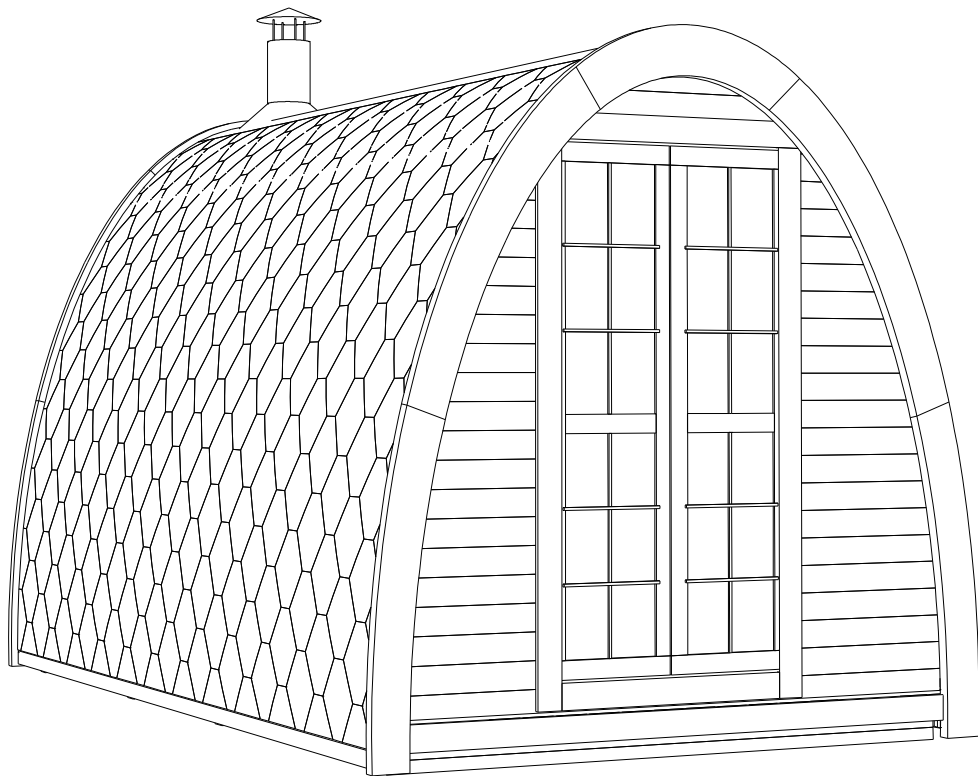

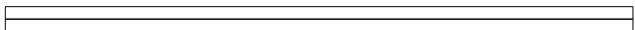







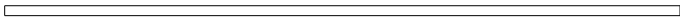















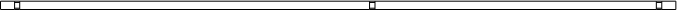

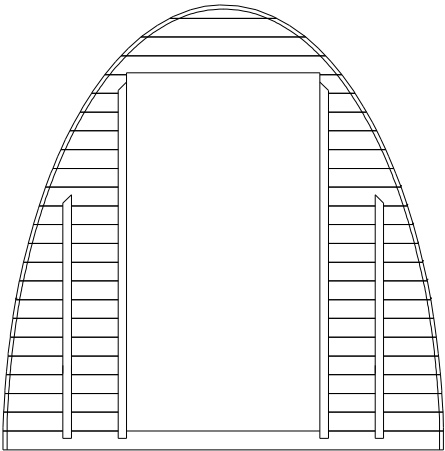

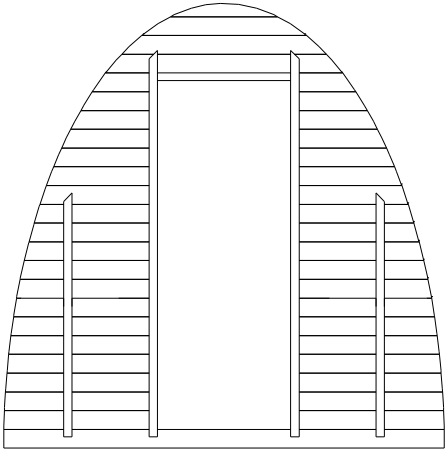

# Sauna pod 2.4x4

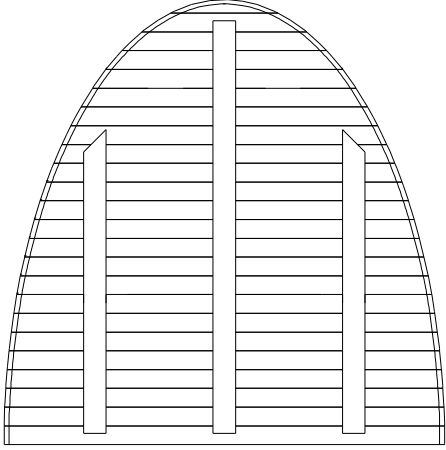

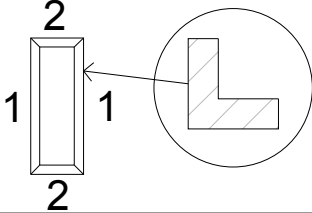





# 1. Sauna pod 2.4x4

No.	Detail		Psc.	
①			4	
②			2	
③			7	
④			3	
⑤			8	
⑦			1	
⑧			1	
⑨			~33	
⑩			~33	
⑪			1	
⑫			1	

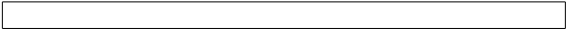

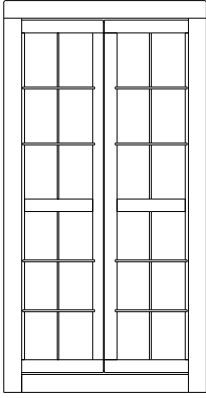
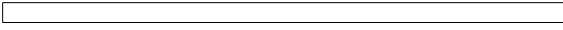



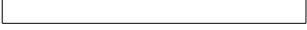
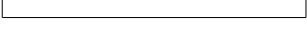
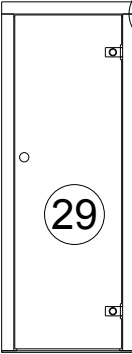

## 2. Sauna pod 2.4x4

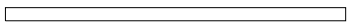
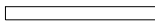
No.	Detail		Psc.	
13			1	
14			1	
15			8	
16			2	
17			2	
18			2	

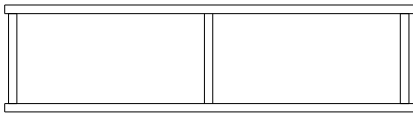

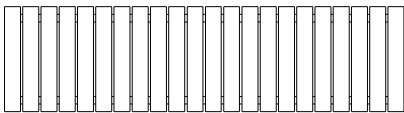
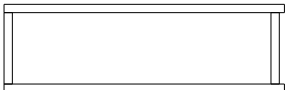

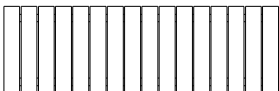

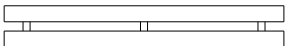

### 3. Sauna pod 2.4x4

No.	Detail	Psc.	
19		25	
20		25	
21		1	
22		2	
23		1	
24		1	
25		1	
25.1		1	
26		1	
27		1	
28 29	 <div style="position: absolute; top: 0; right: 0;">28</div> <div style="position: absolute; top: 50%; left: 50%; transform: translate(-50%, -50%);">29</div>	1	

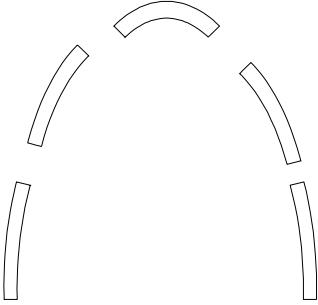

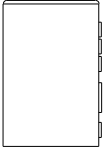

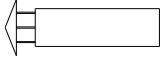

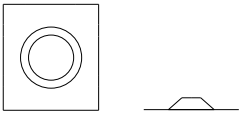
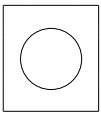



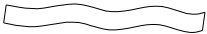
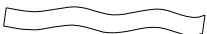

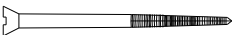
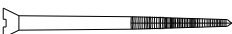

## 4. Sauna pod 2.4x4

No.	Detail	Psc.	
30		4	
31		2	
32		1	
33		2	
34		4	
35		2	
36		2	
37		4	
38		2	
39		2	
40		6	
41		2	

## 5. Sauna pod 2.4x4

No.	Detail	Psc.	
42		1	
43		1	
44		10	
45		2	
46		1	
47		2	
48		1	
49		1	
50		1	
51		1	

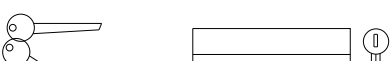
## 6. Sauna pod 2.4x4

No.	Detail	Psc.	
A0		2	
A1		2	
A2		1	
A3		180	
A4		90	
A5		24	
A6		251	
A7		375	
A8		40	
A9		1p	
A10		60	
A11		90	
A12		150	
A13		20	
A14		1	
A15		1	
A16		1	
A17		2	

# Sauna pod 2.4x4

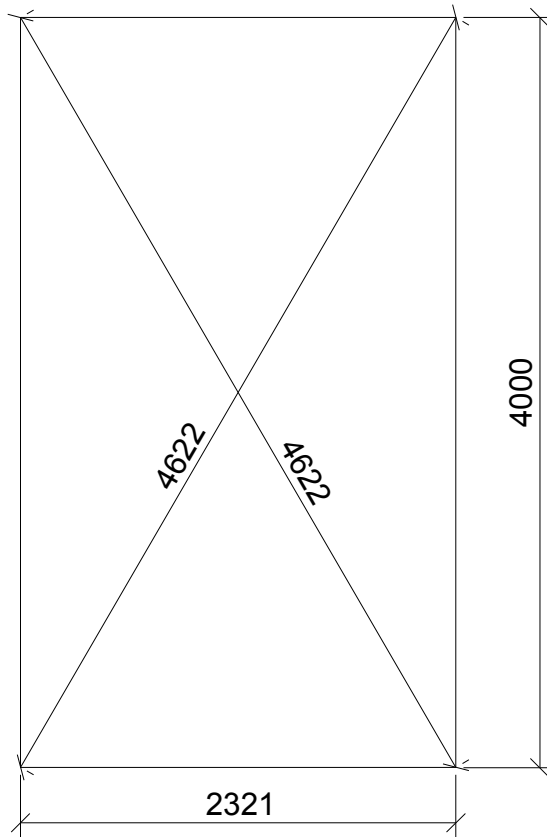
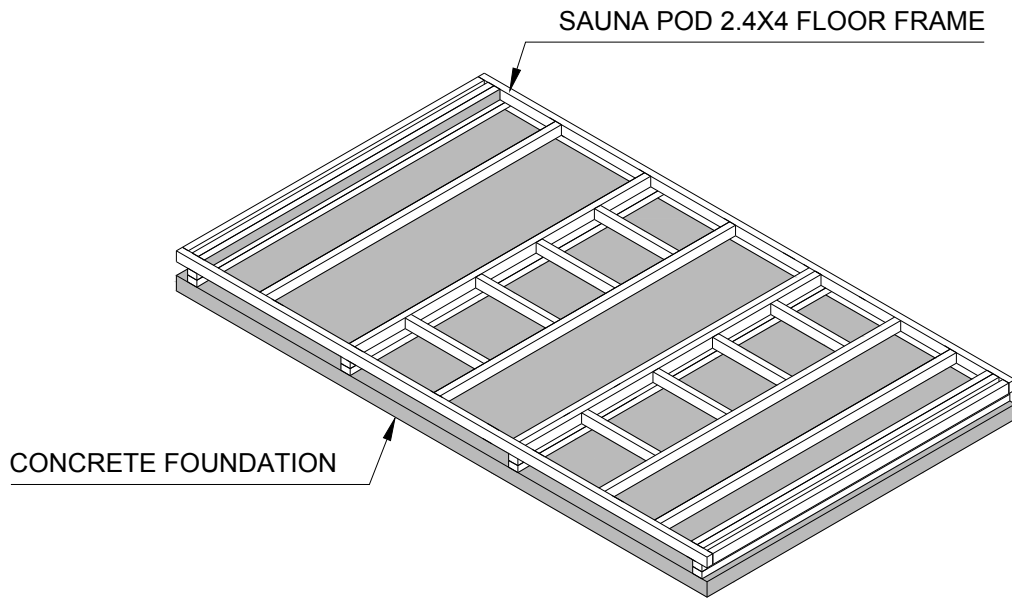



# 1. Sauna pod 2.4x4

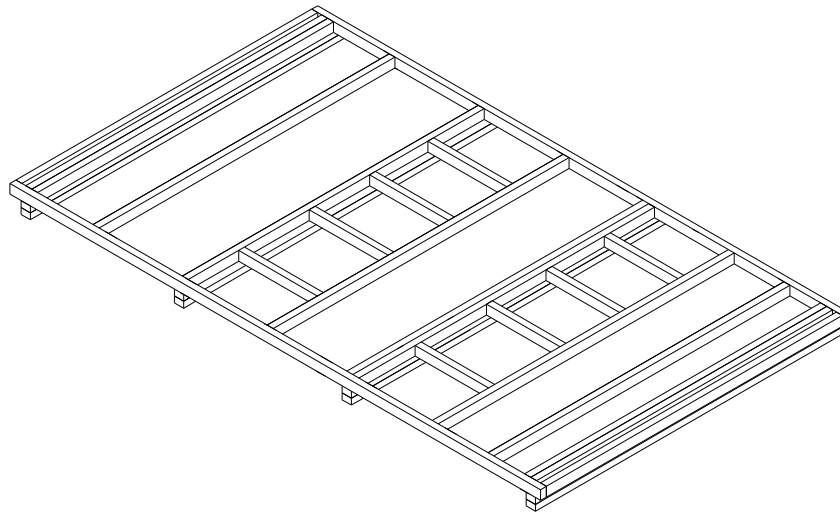

1

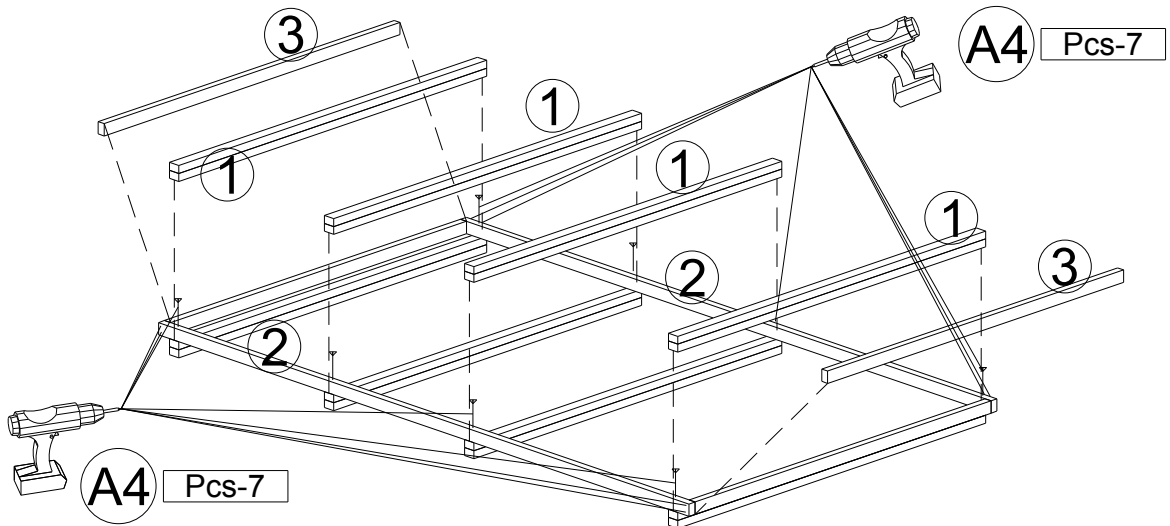

2

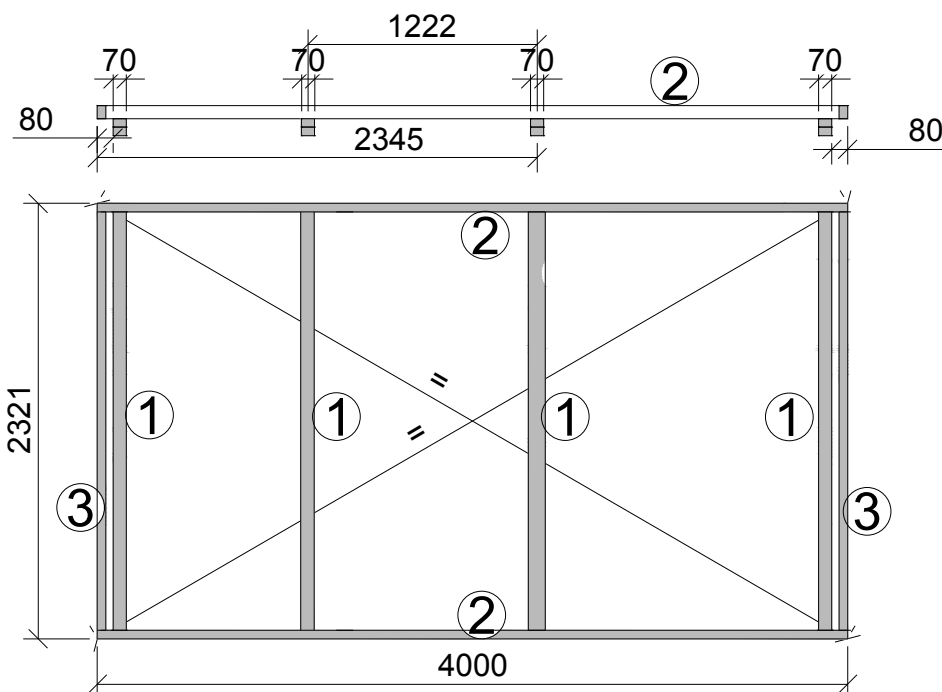

## 2. Sauna pod 2.4x4

1

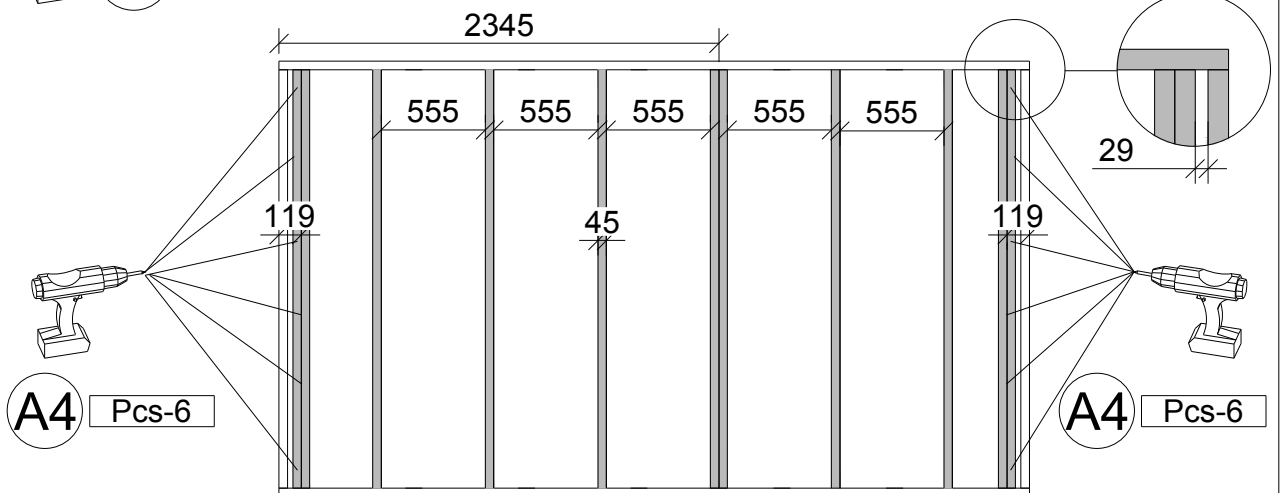
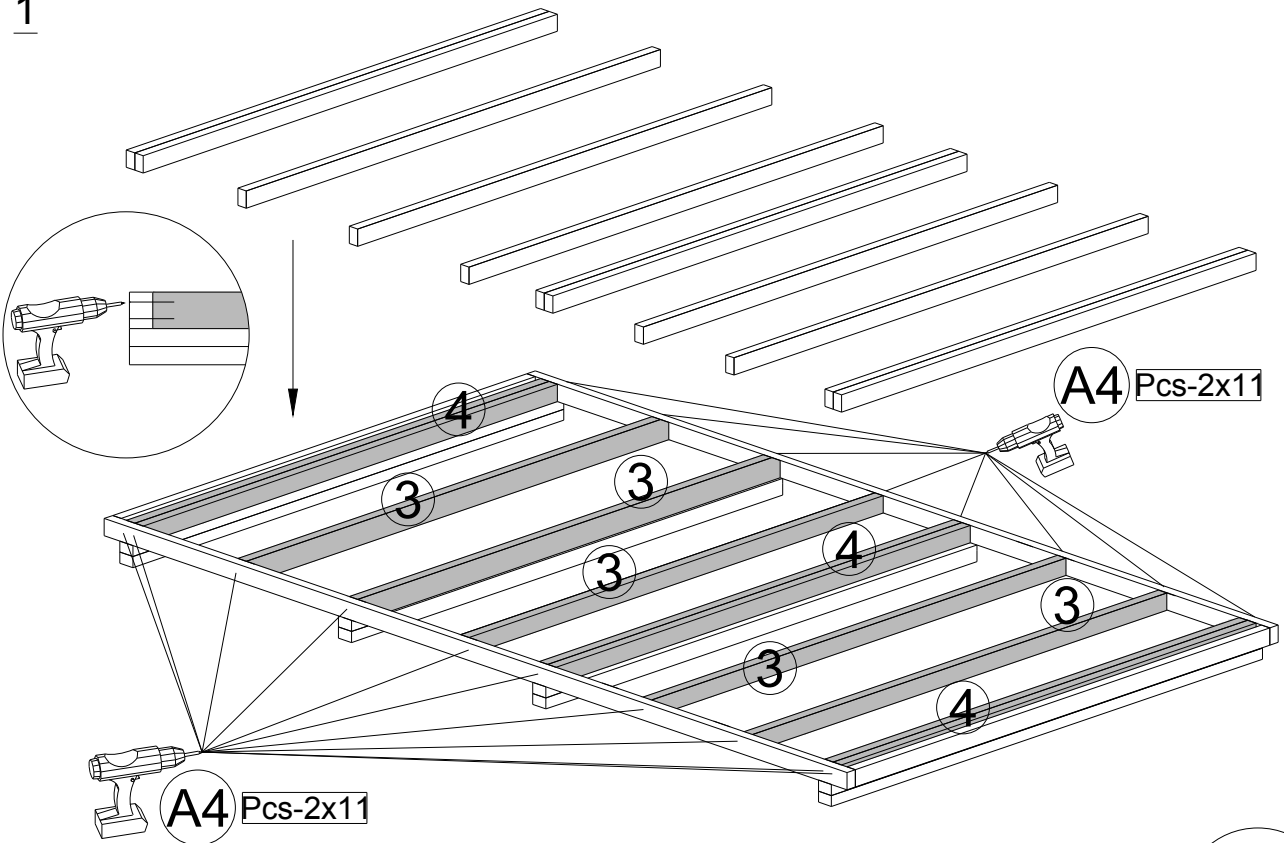

2

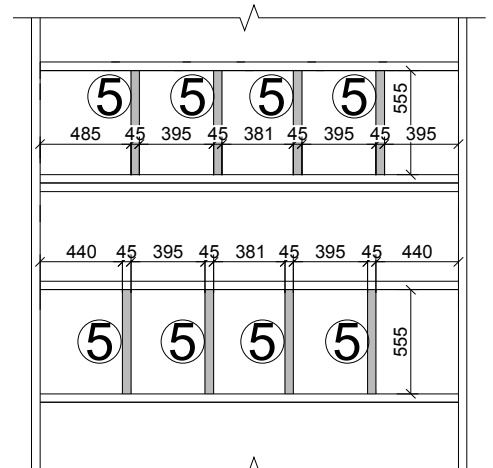
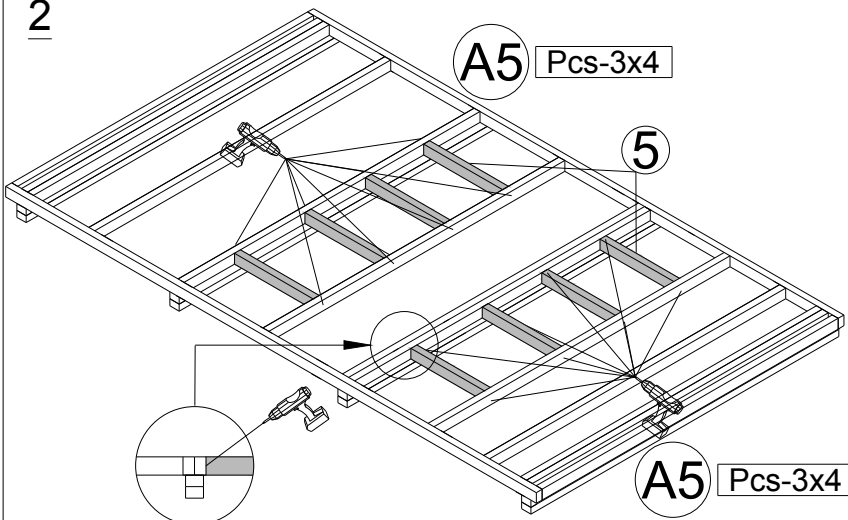

### 3. Sauna pod 2.4x4

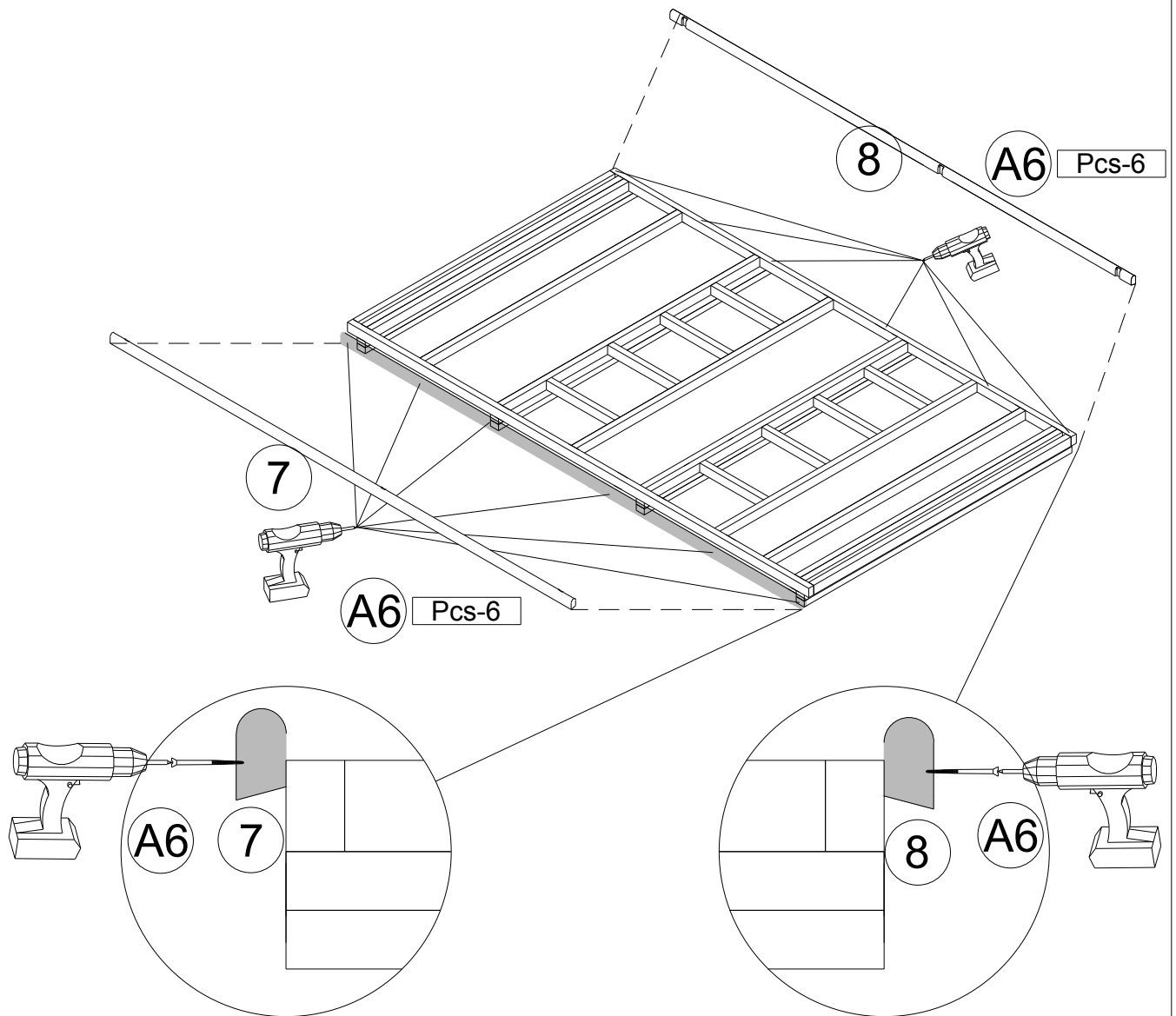

# 4. Sauna pod 2.4x4

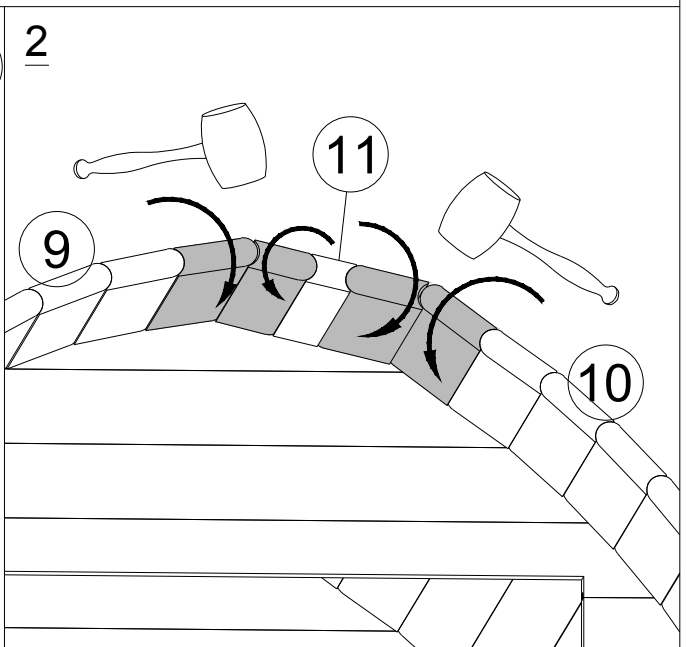
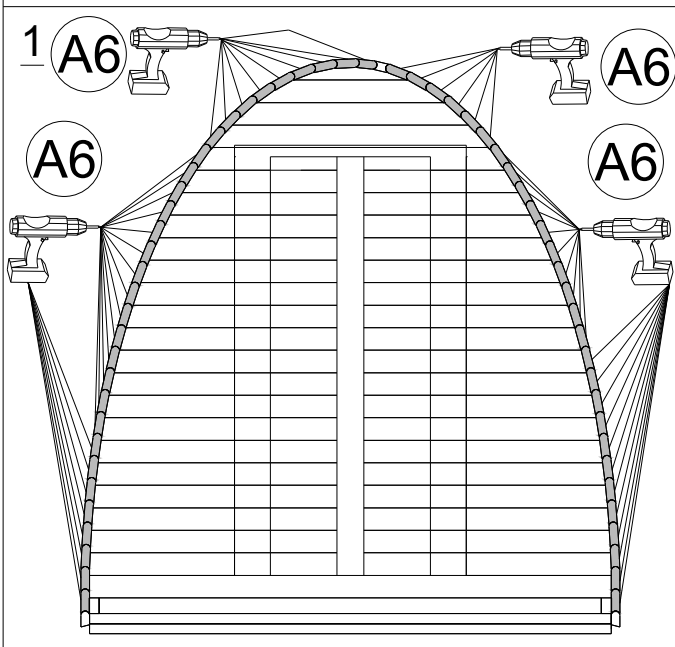
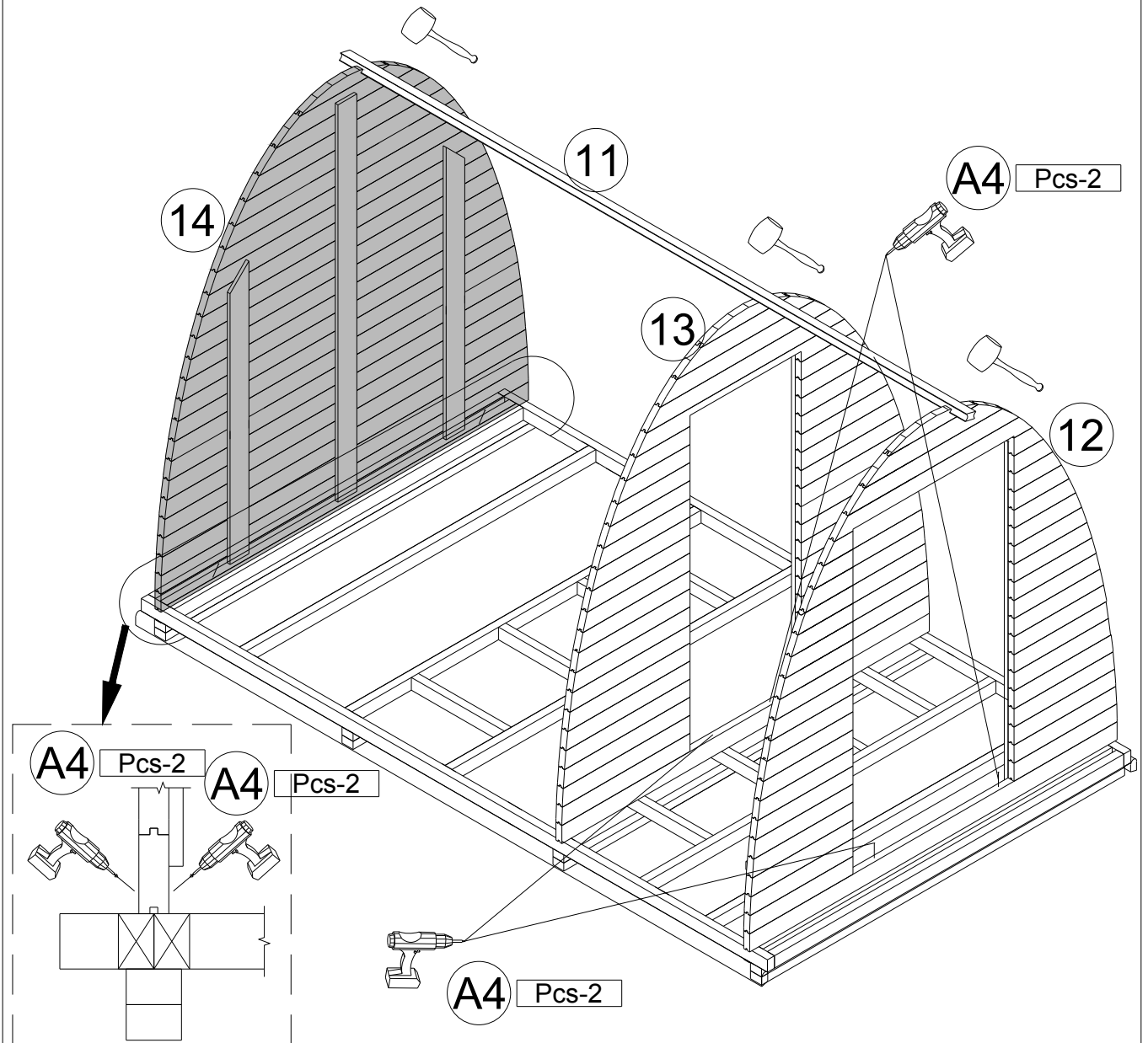

# 5. Sauna pod 2.4x4

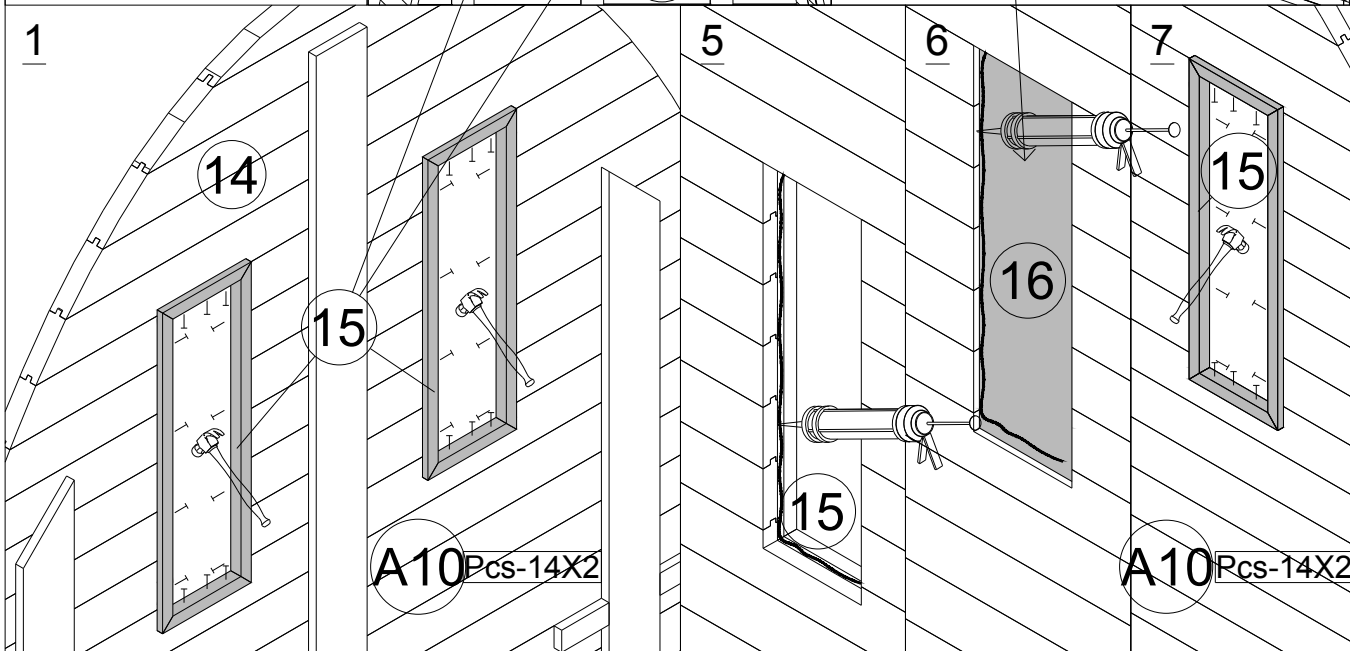
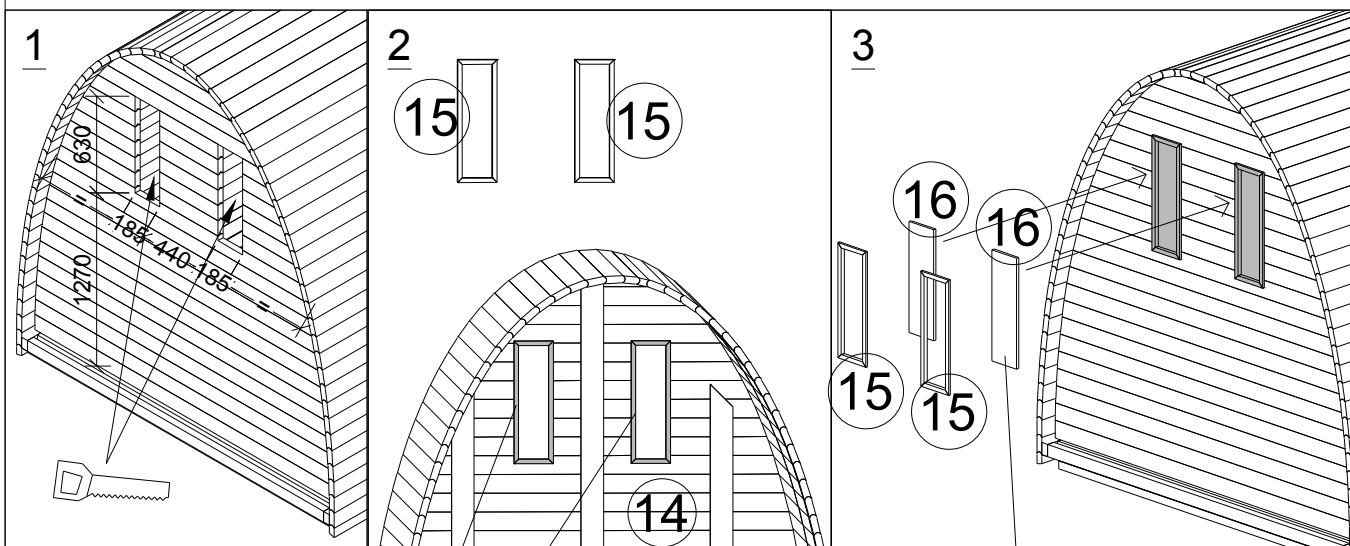
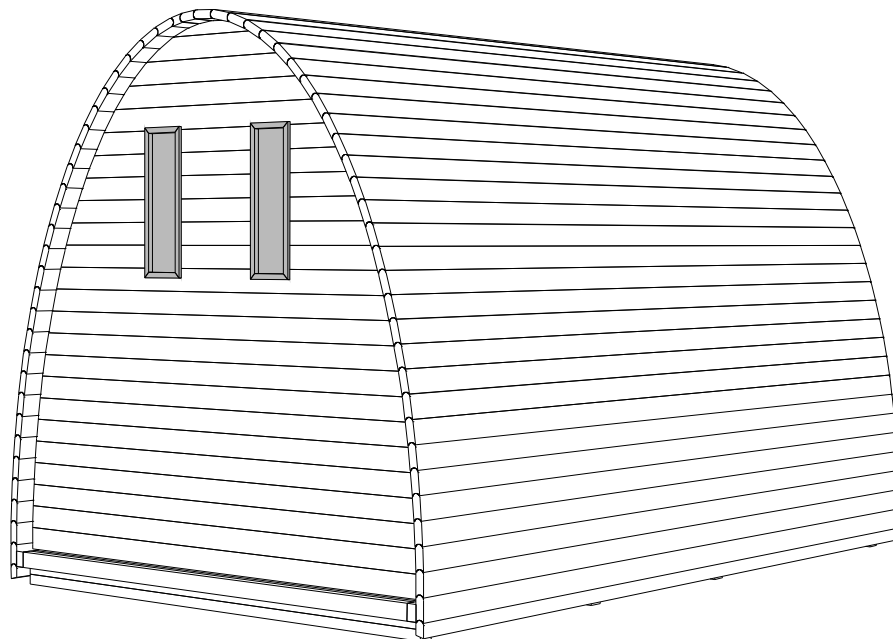

## 6. Sauna pod 2.4x4

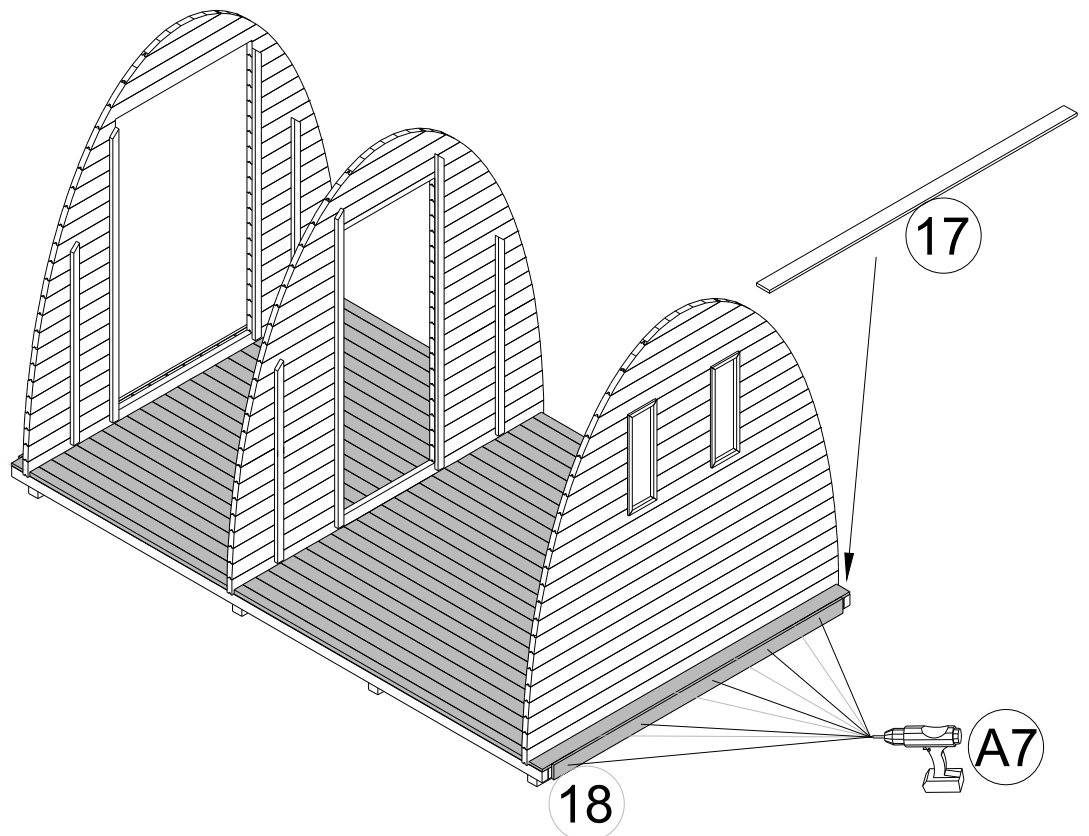
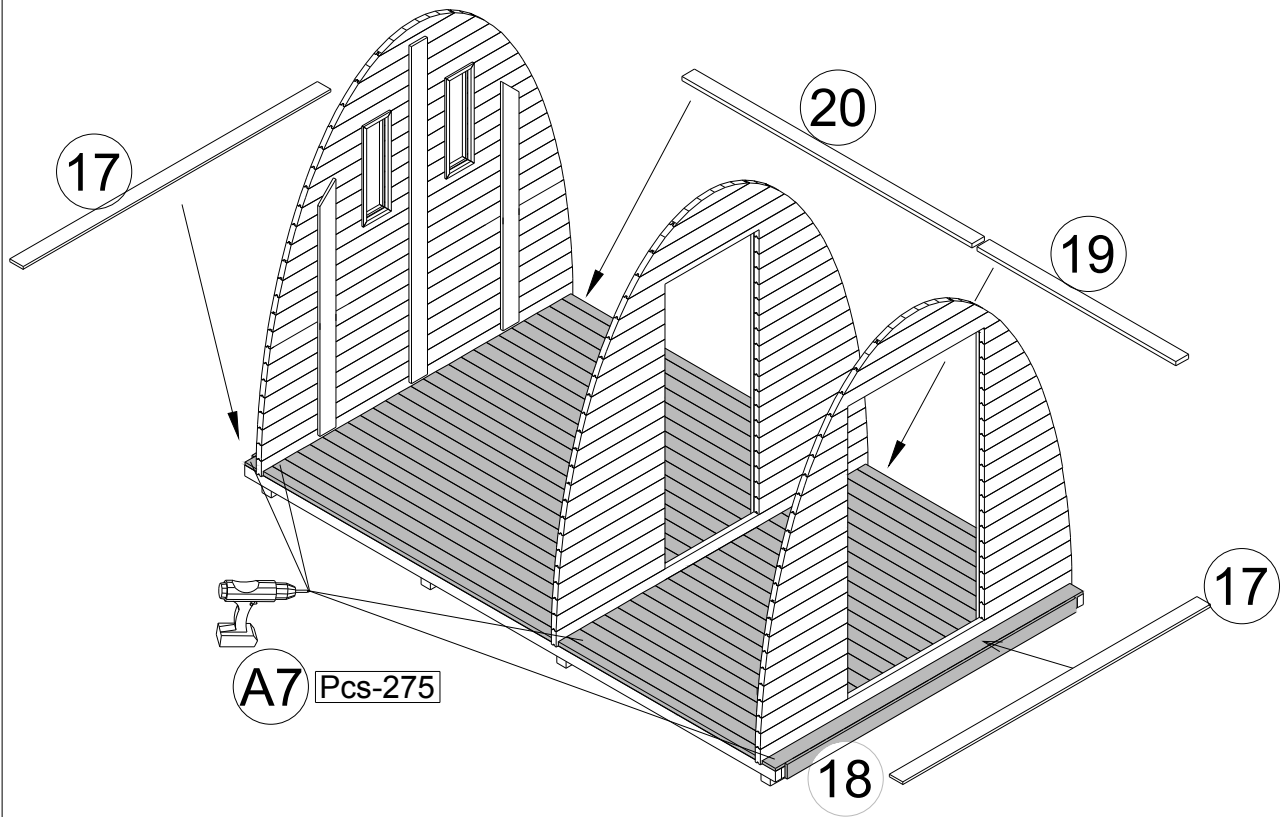

# 7. Sauna pod 2.4x4

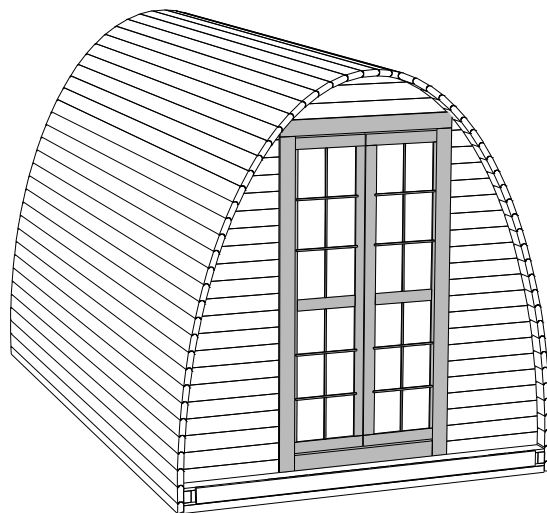

1

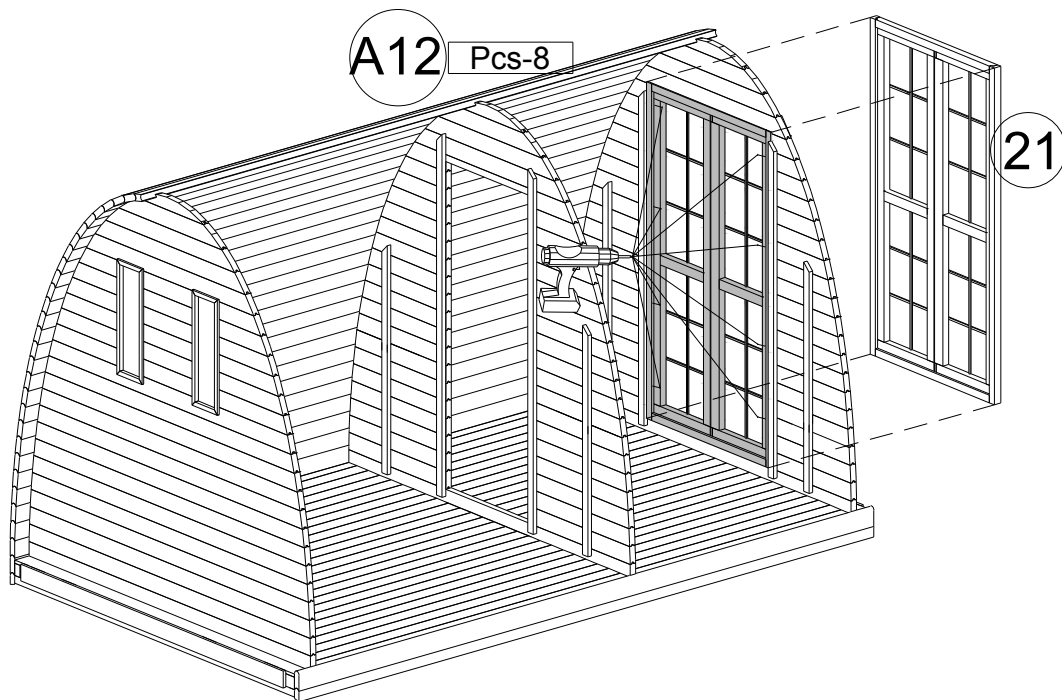

2

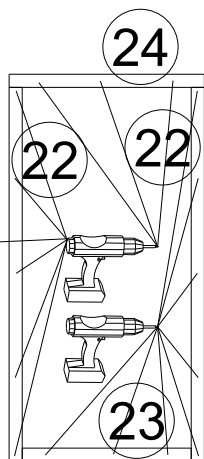
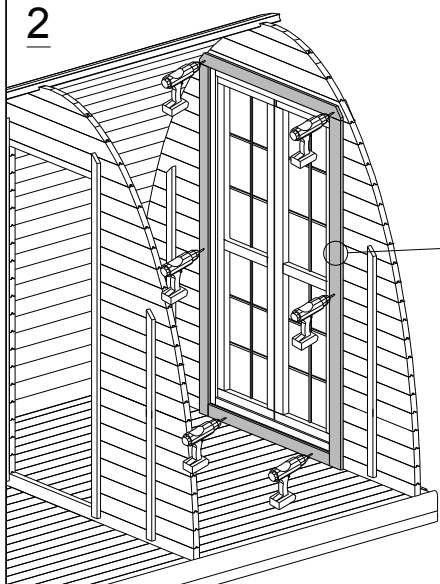

A7 Pcs-26

3

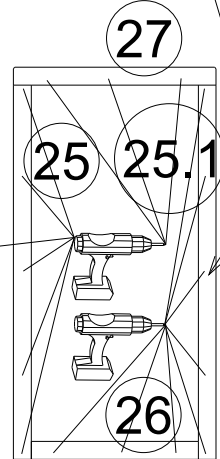
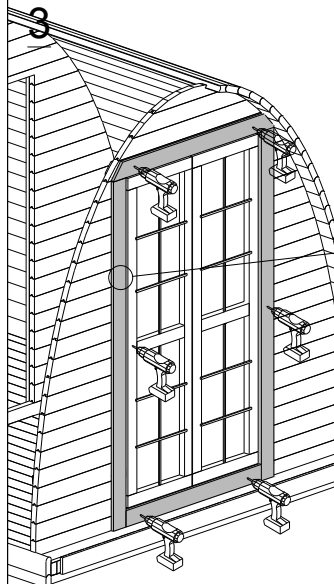

A7 Pcs-26

# 8. Sauna pod 2.4x4

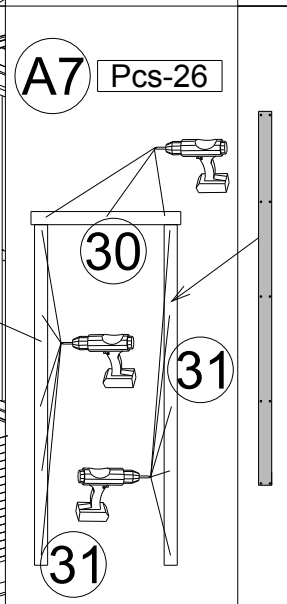
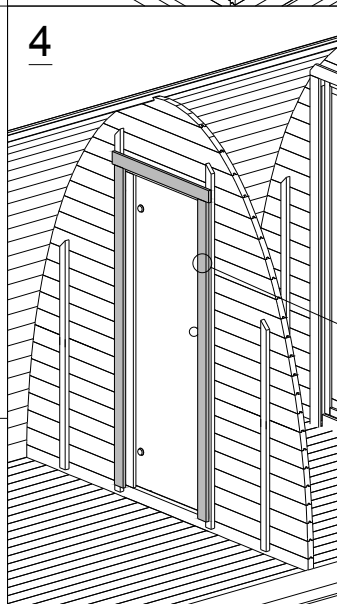
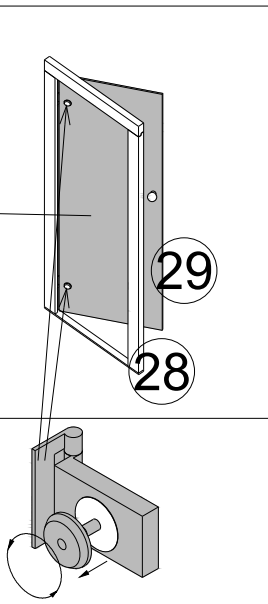
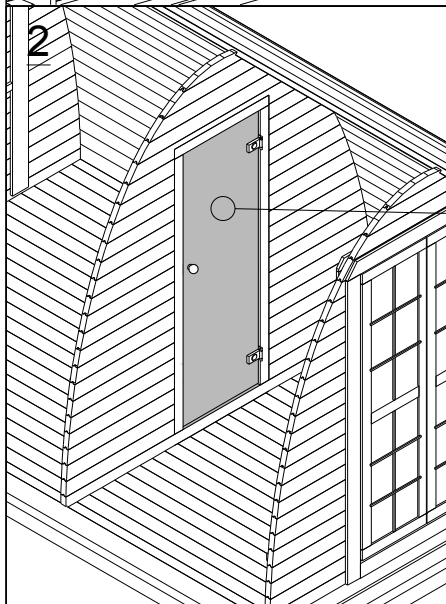
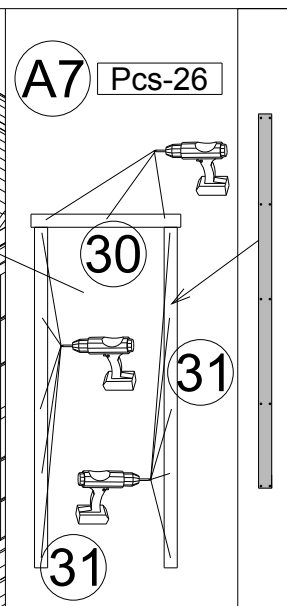
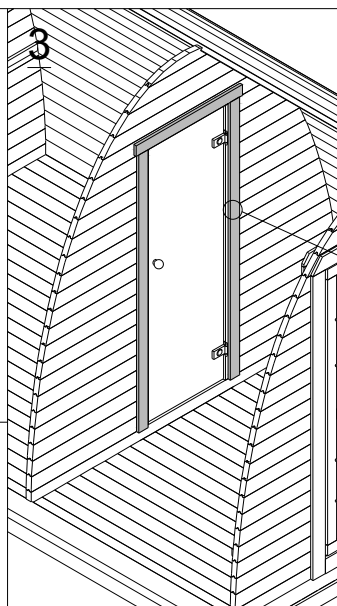
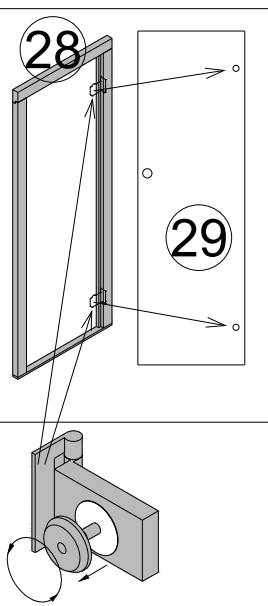
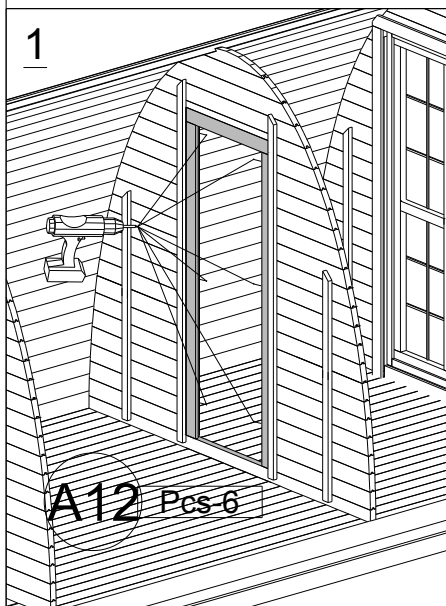
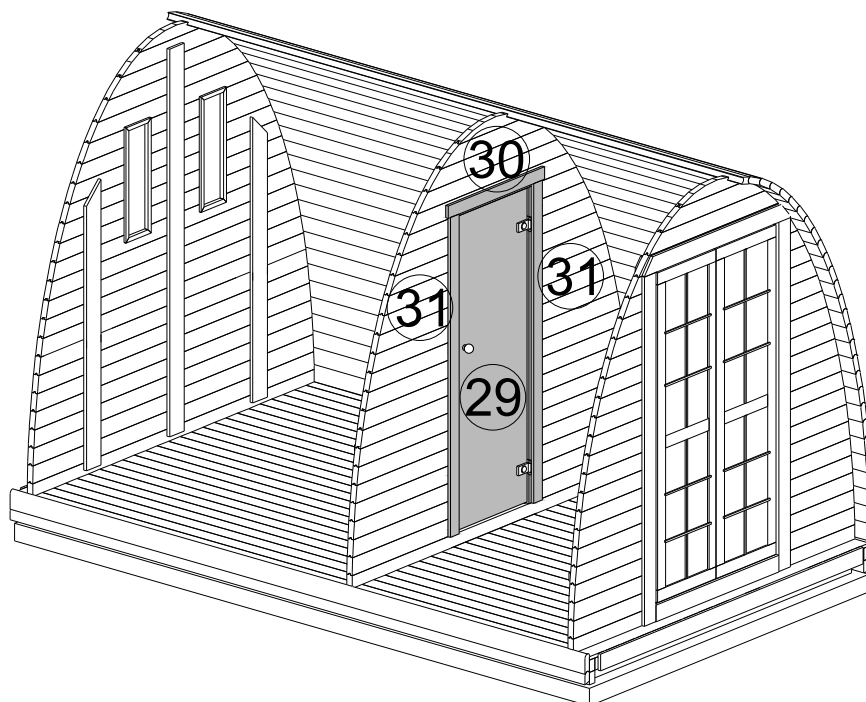



# 9. Sauna pod 2.4x4

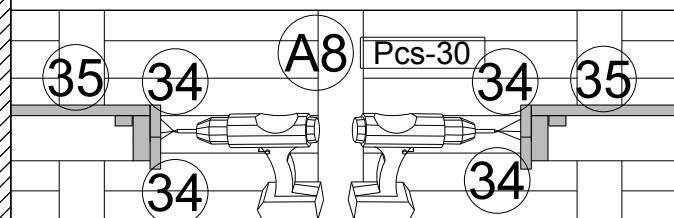
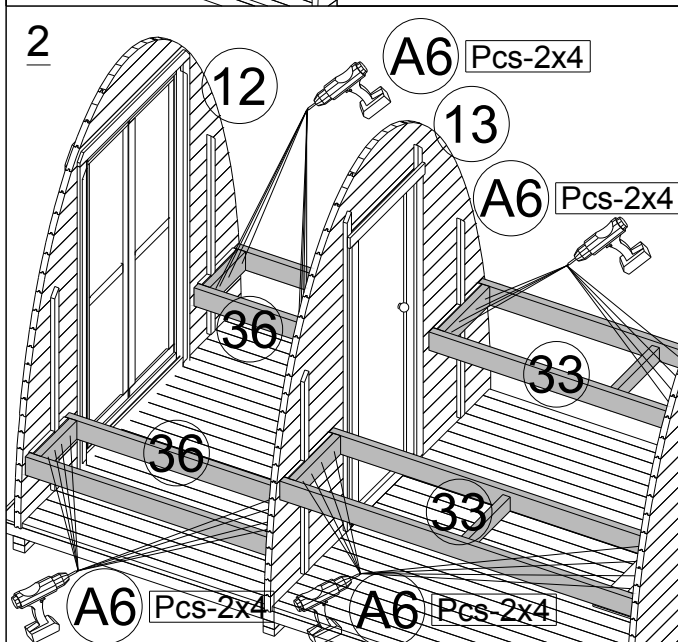
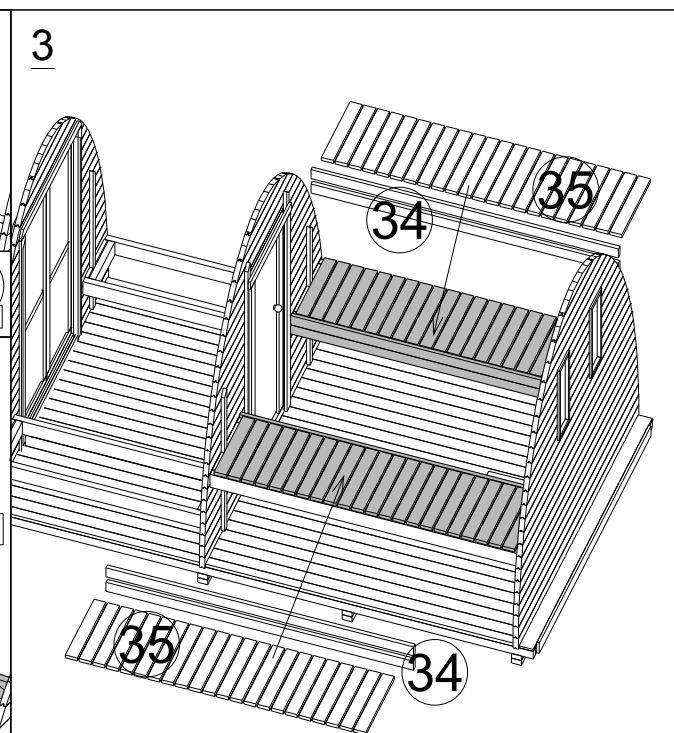
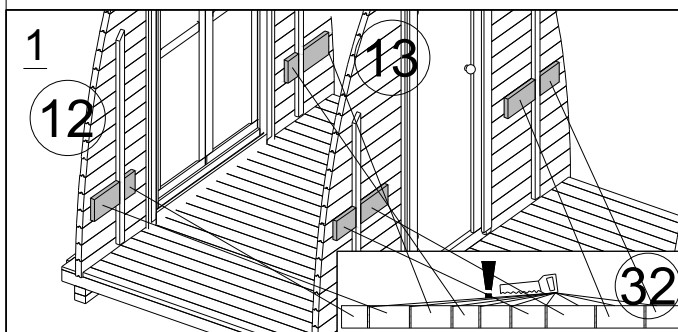
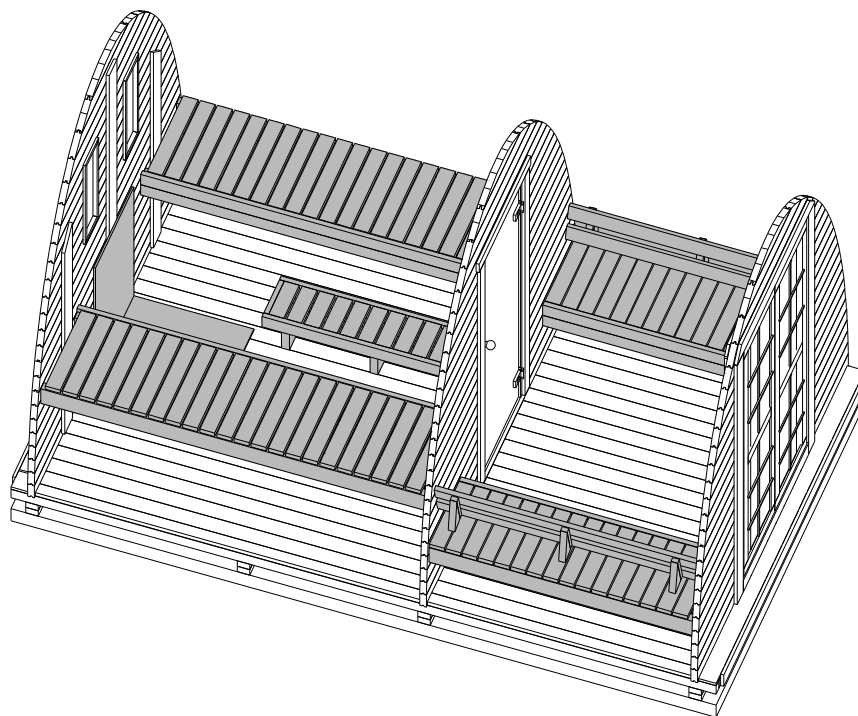

# 10. Sauna pod 2.4x4

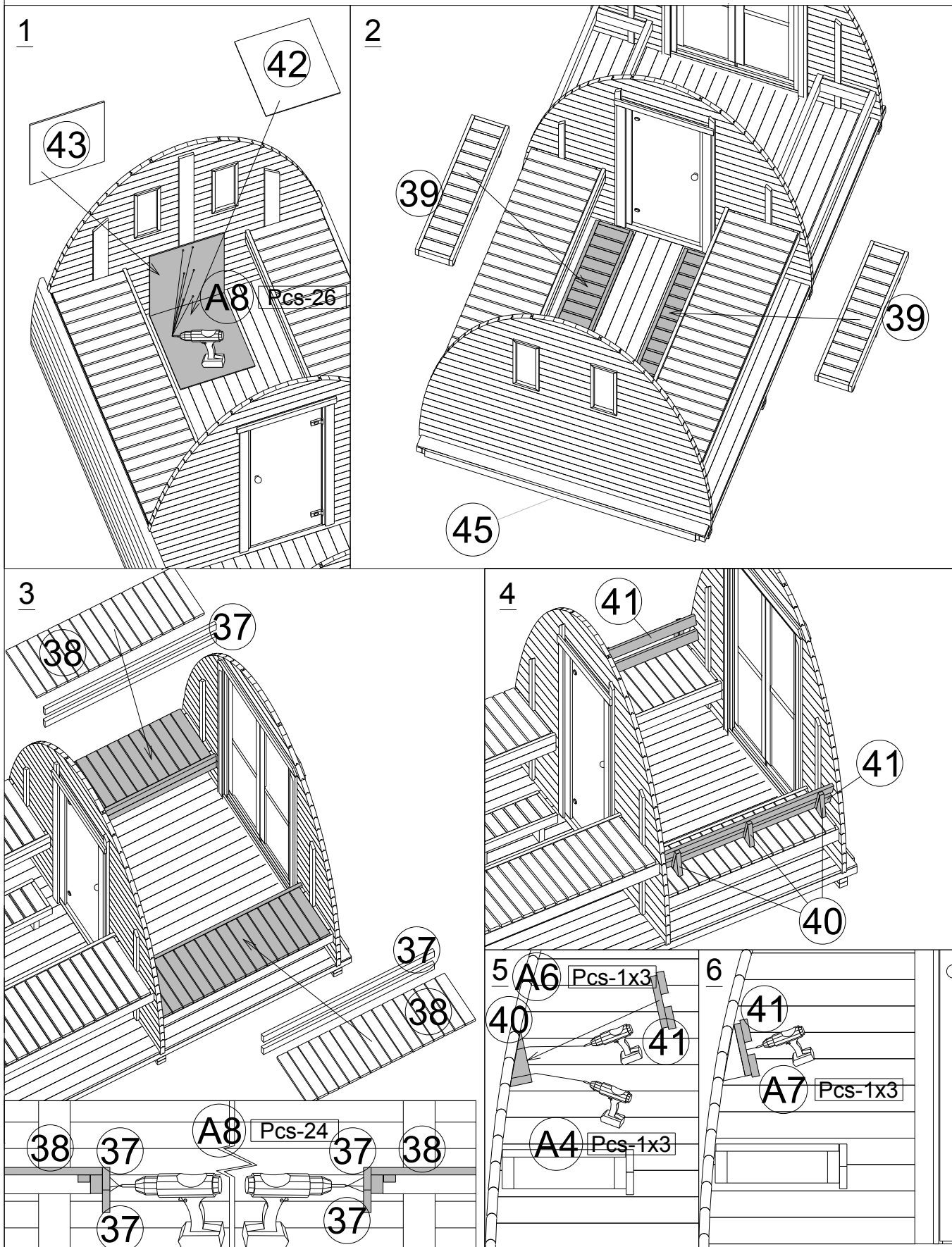

# 11. Sauna pod 2.4x4

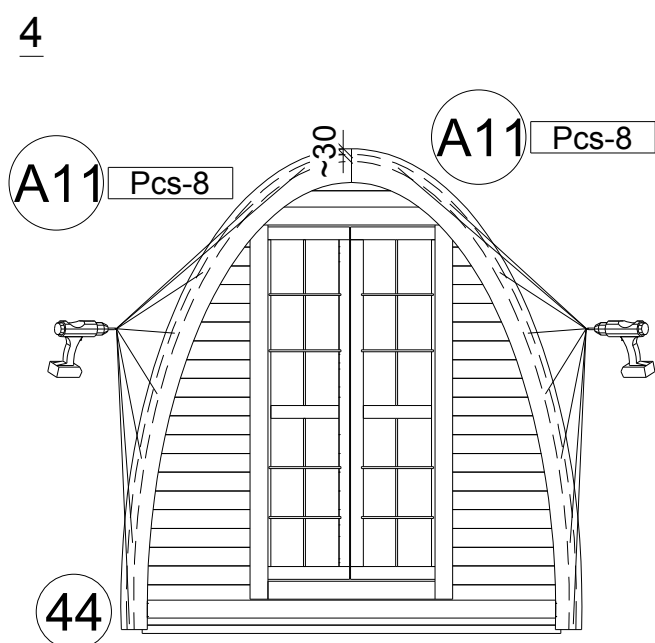
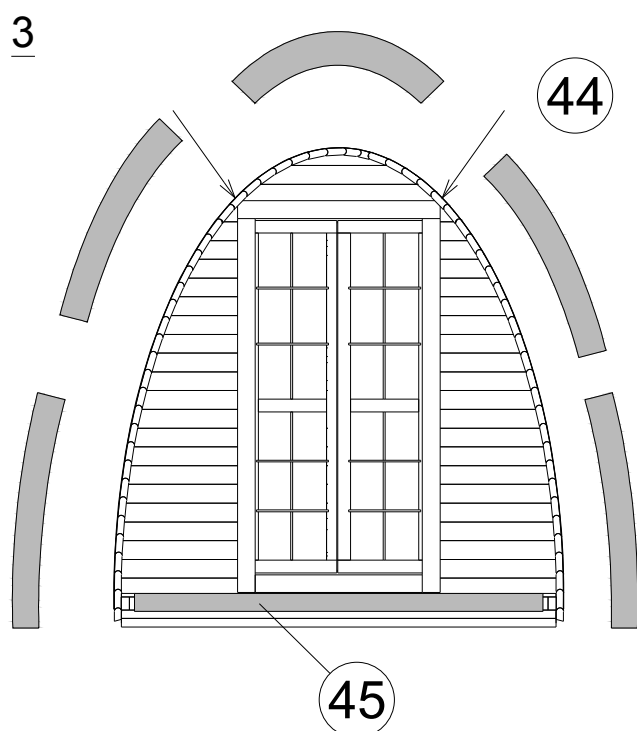
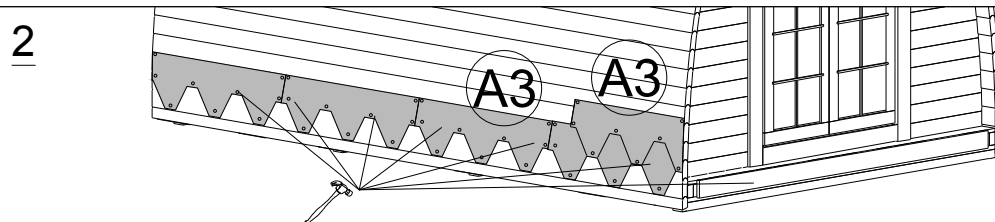
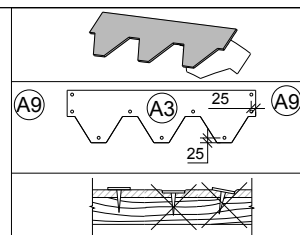
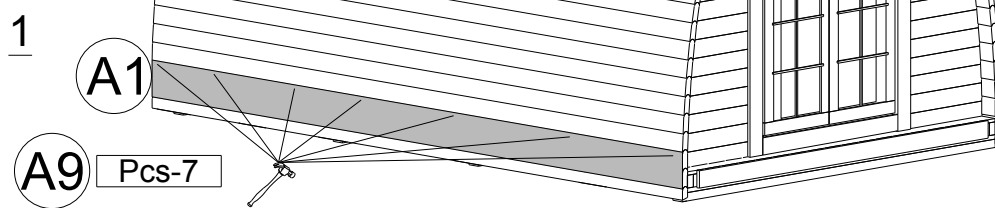
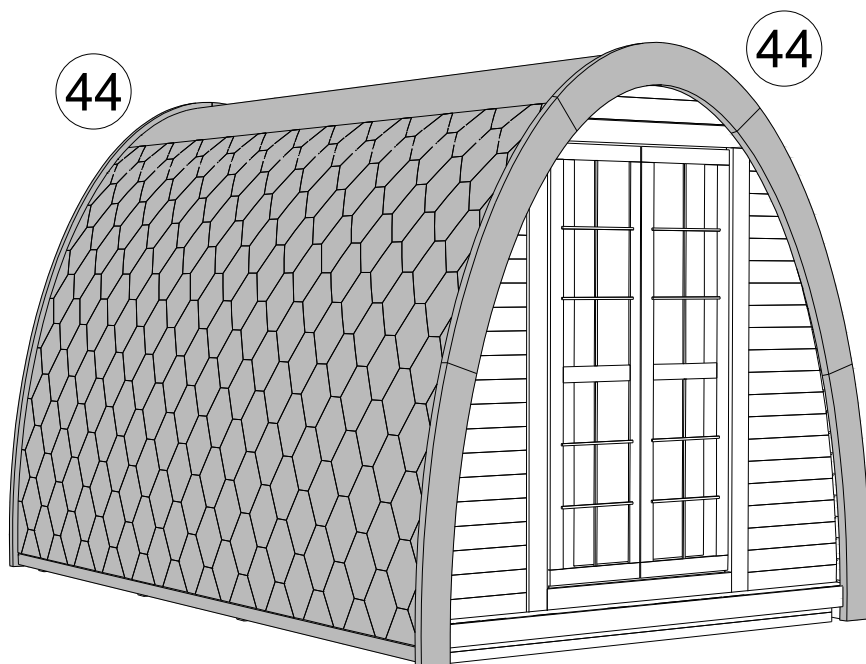

## 12. Sauna pod 2.4x4

1

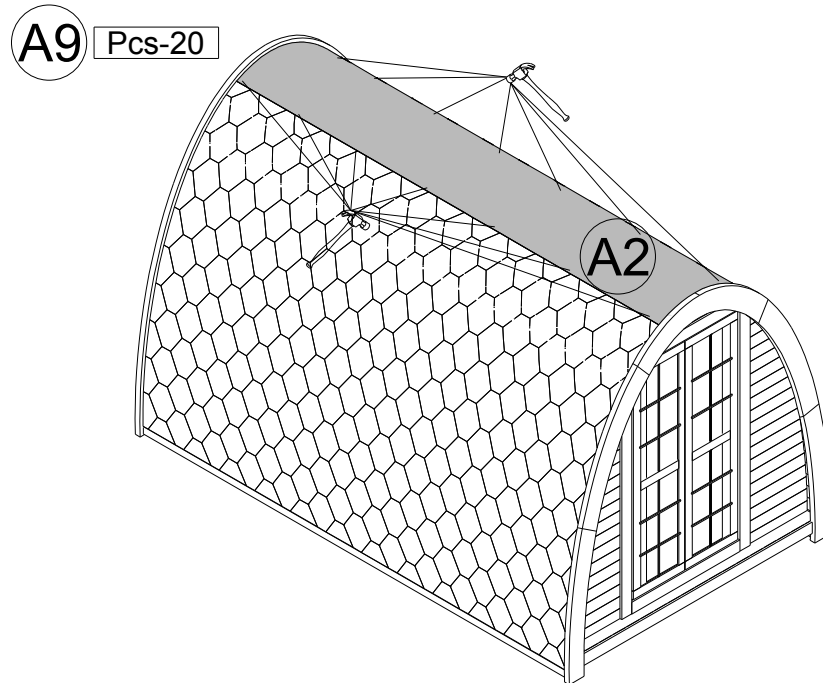

2

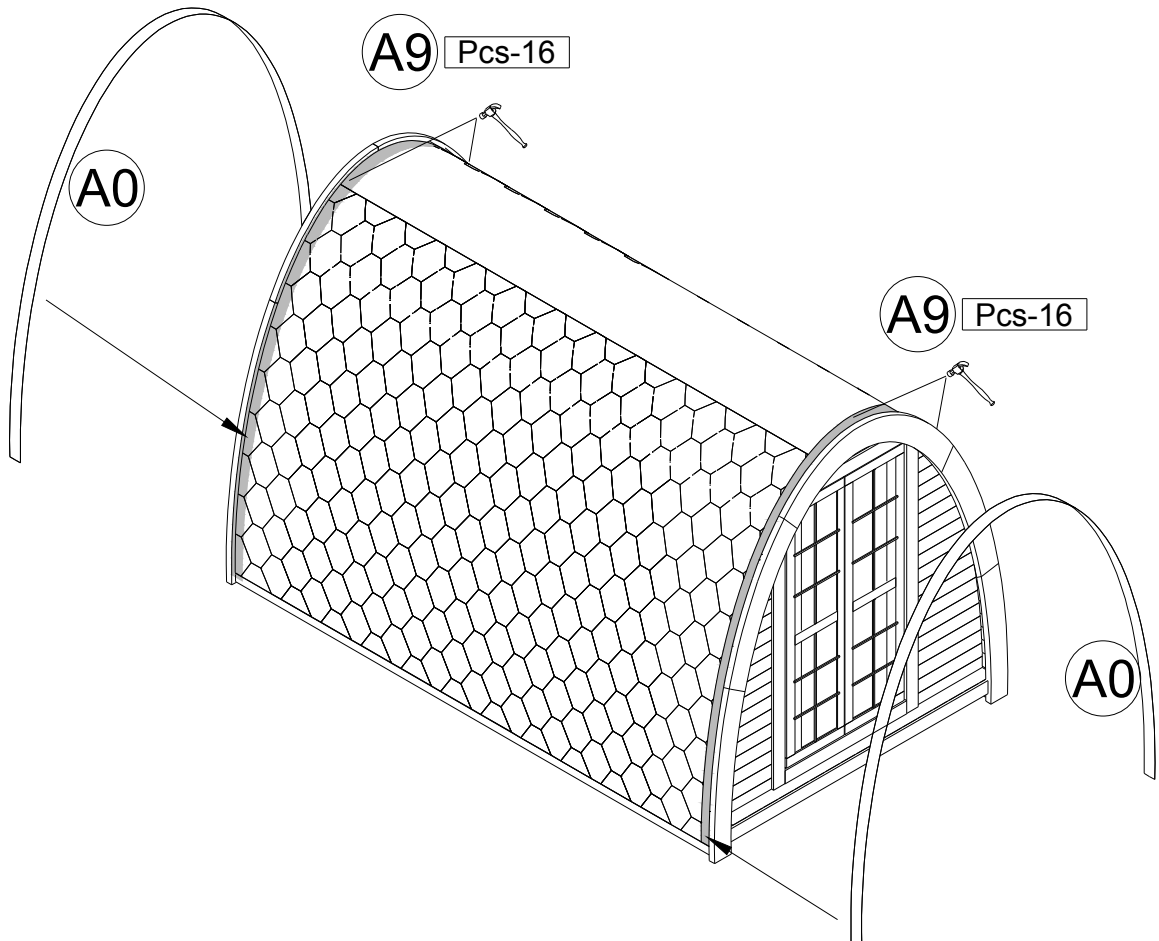

# 13. Sauna pod 2.4x4

