

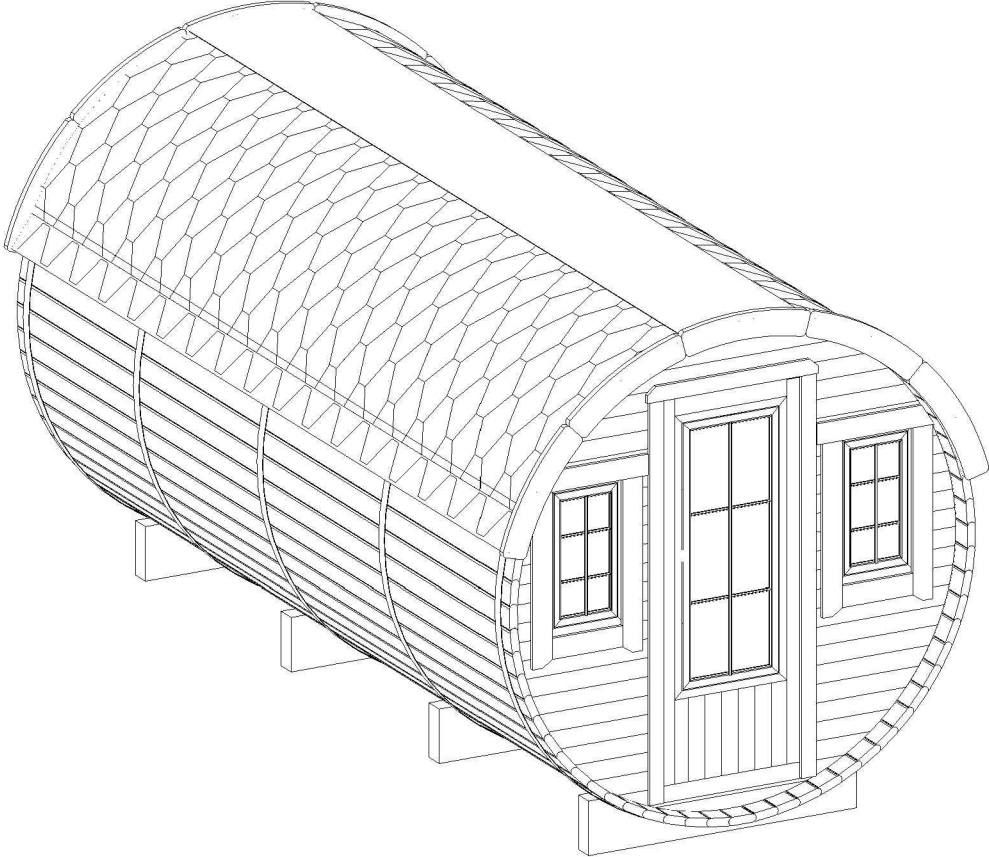

















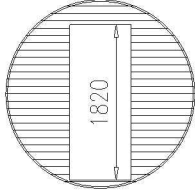
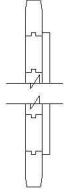
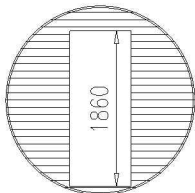
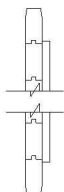
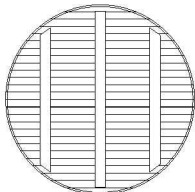
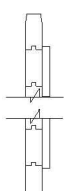
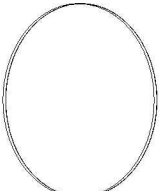

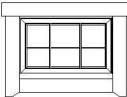







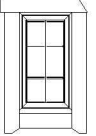

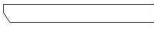









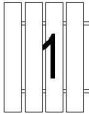

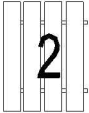

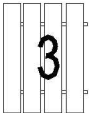

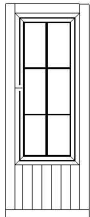



















Sleeping barrel 4.4 x Ø2.2













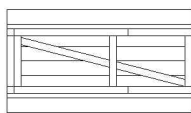











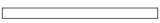





1. SLEEPING BARREL- 4.4 x \varnothing 2.2

| No. | Detail | | Pcs | |
|------|---|---|---------|--|
| 1 |  |  | 4 | |
| 2 |  |  | 1 | |
| 3 |  |  | 29 - 40 | |
| 4 |  |  | 29 - 40 | |
| 5 |  |  | 1 | |
| 6 |  |  | 1 | |
| 7 |  |  | 1 | |
| 8 |  |  | 1 | |
| 9 |  |  | 5 | |
| 10 |  |  | 1 | |
| 10.1 |  |  | 1 | |
| 10.2 |  |  | 2 | |
| 10.3 |  |  | 1 | |
| 11 |  |  | 2 | |
| 11.1 |  |  | 4 | |
| 11.2 |  |  | 2 | |
| 11.3 |  |  | 2 | |

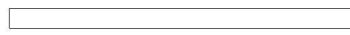

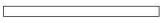



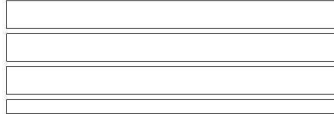
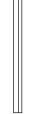

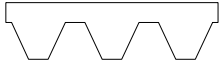
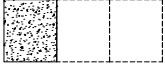

2. SLEEPING BARREL- 4.4 x ϕ 2.2

| No. | Detail | | Pcs | |
|------|---|---|-----|--|
| 12 |  |  | 2 | |
| 13 |  |  | 1 | |
| 14 |  |  | 1 | |
| 15 |  |  | 1 | |
| 16 |  |  | 1 | |
| 17 |  |  | 1 | |
| 17.1 |  |  | 2 | |
| 17.2 |  |  | 1 | |
| 17.3 |  |  | 1 | |
| 17.4 |  |  | 2 | |
| 18 |  |  | 1 | |
| 18.1 |  |  | 2 | |
| 19 |  |  | 2 | |
| 20 |  |  | 2 | |
| 21 |  |  | 10 | |
| 22 |  |  | 2 | |
| 23 |  |  | 2 | |
| 24 |  |  | 2 | |
| 25 |  |  | 4 | |



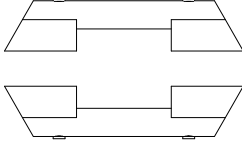
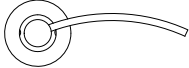
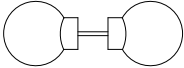

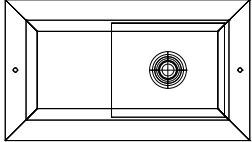





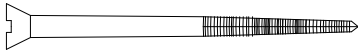

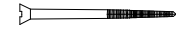
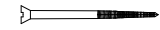



3. SLEEPING BARREL- 4.4 x \varnothing 2.2

| No. | Detail | | Pcs | |
|------|---|---|-----|--|
| 26 |  |  | 1 | |
| 27 |  |  | 16 | |
| 28 |  |  | 6 | |
| 29 |  |  | 1 | |
| 30 |  |  | 1 | |
| 31 |  |  | 1 | |
| 32 |  |  | 1 | |
| 33 |  |  | 2 | |
| 34 |  |  | 2 | |
| 34.1 |  |  | 2 | |
| 35 |  |  | 8 | |
| 35.1 |  |  | 2 | |
| 36 |  |  | 2 | |
| 37 |  |  | 2 | |
| 38 |  |  | 2 | |
| | | | | |
| | | | | |
| | | | | |
| | | | | |
| | | | | |

4. SLEEPING BARREL- 4.4 x \varnothing 2.2

| No. | Detail | Pcs | |
|-----|--|-------|--|
| S1 |  | 88 | |
| S2 |  | _____ | |
| S3 |  | _____ | |
| S4 |  | _____ | |
| S5 |  | 2 | |
| S6 |  | 1 | |
| S7 |  | _____ | |
| S8 |  | _____ | |
| | | | |
| T1 |  | _____ | |
| T2 |  | _____ | |
| T3 |  | 1 | |
| T4 |  | 1 | |
| T5 |  | 2 | |
| T6 |  | 2 | |
| T7 |  | _____ | |

5. SLEEPING BARREL- 4.4 x \varnothing 2.2

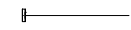
| No. | Detail | Pcs | |
|-----|---|-----|--|
| A0 |  | — | |
| A1 |  | — | |
| A2 |  | — | |
| A3 |  | 8 | |
| A4 |  | 60 | |
| A5 |  | 146 | |
| A6 |  | 20 | |
| A7 |  | — | |
| A8 |  | 32 | |
| A9 |  | — | |
| A10 |  | — | |
| A11 |  | 380 | |
| A12 |  | — | |
| A13 |  | — | |
| A14 |  | — | |
| A15 |  | — | |
| A16 |  | — | |
| A17 |  | — | |
| A18 |  | 1p | |
| A19 |  | 1p | |
| A20 |  | — | |
| | | | |
| | | | |
| | | | |
| | | | |
| | | | |

1. Sleeping barrel 4.4 x Ø2.2

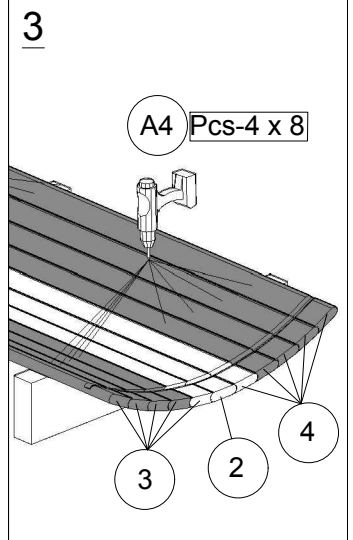
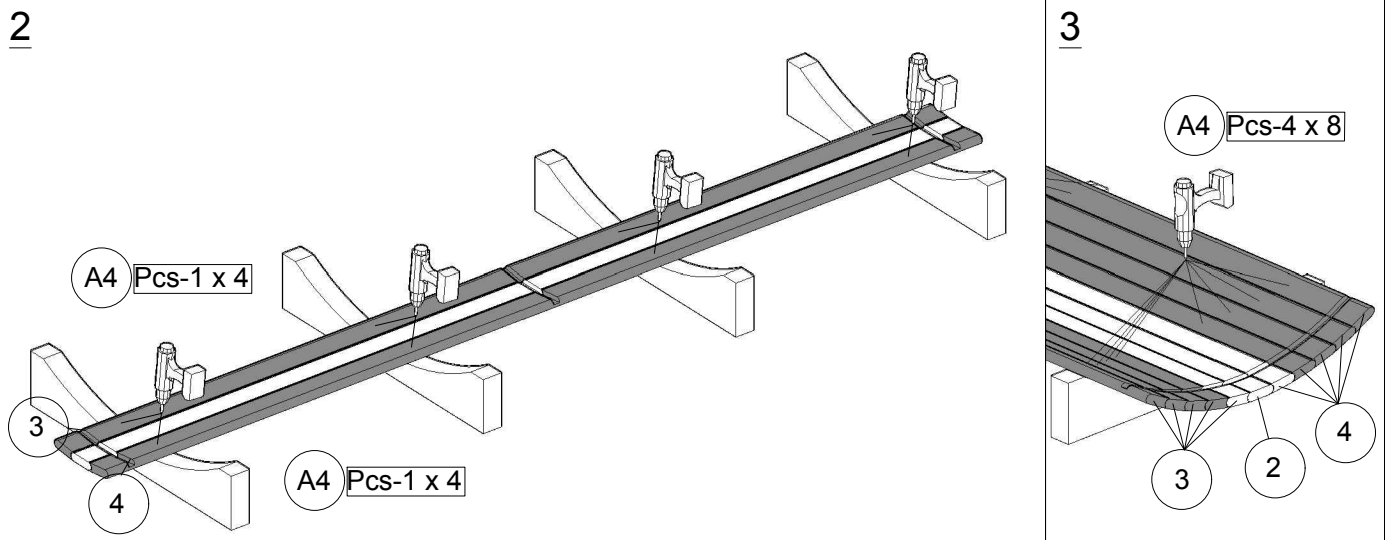
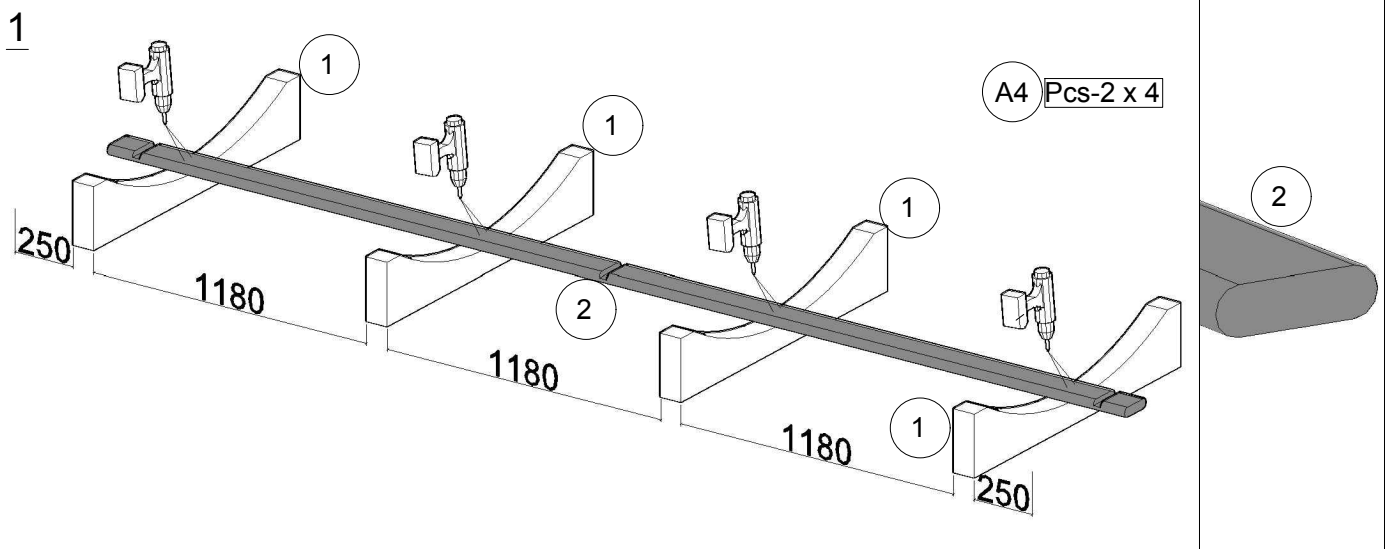
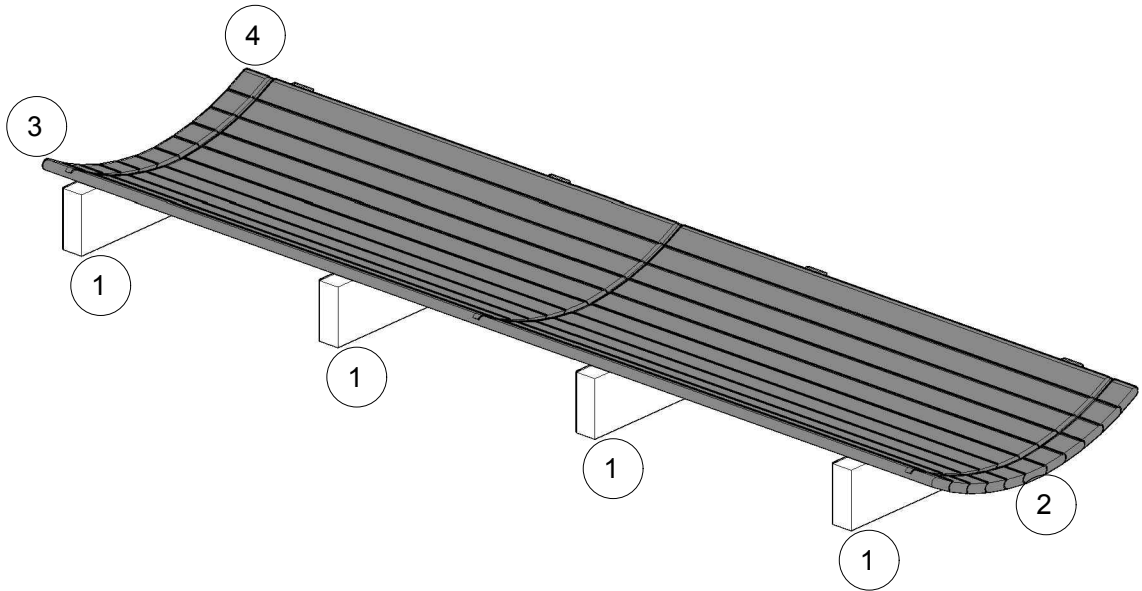

2. Sleeping barrel 4.4 x Ø2.2

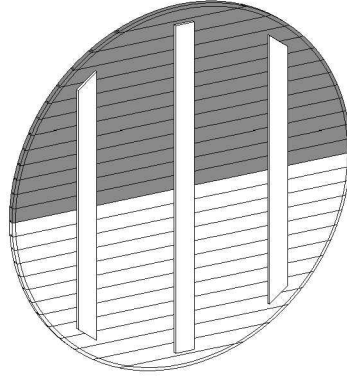

1

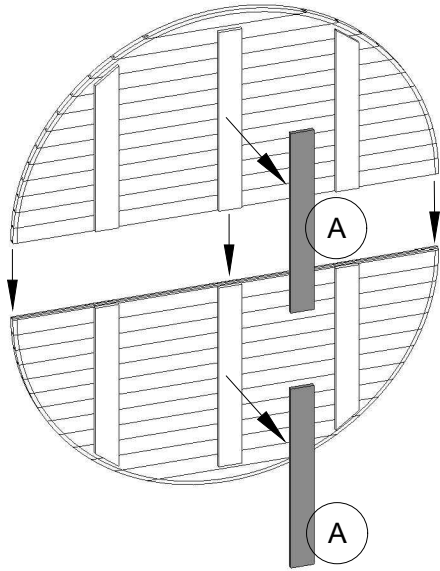

3

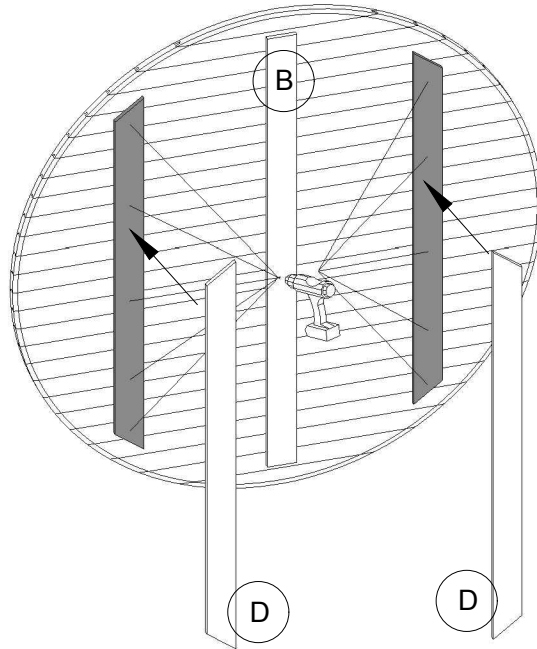

2

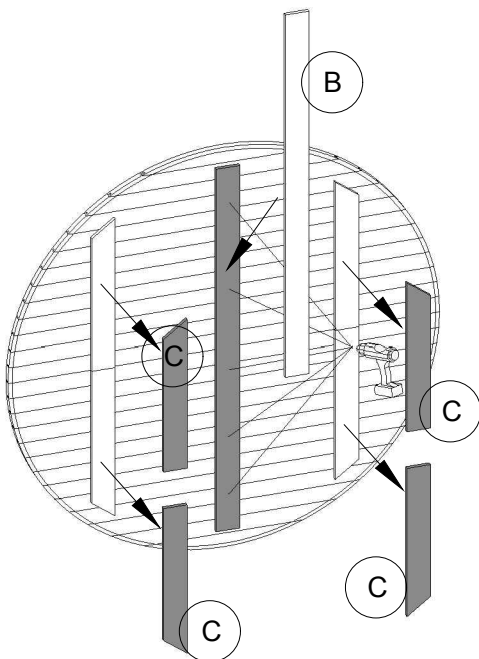

B

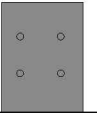

D

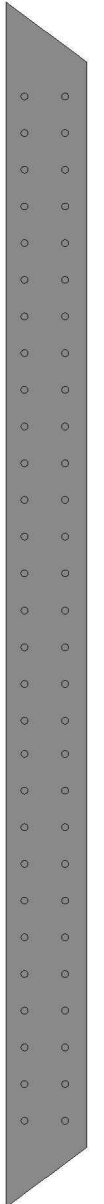

3. Sleeping barrel 4.4 x Ø2.2

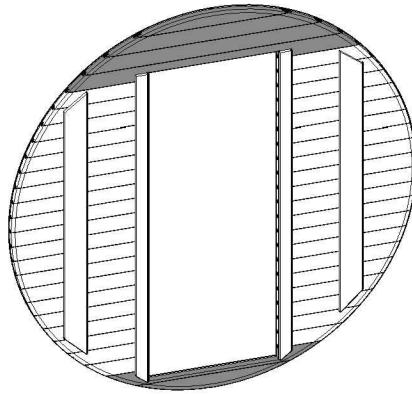

1

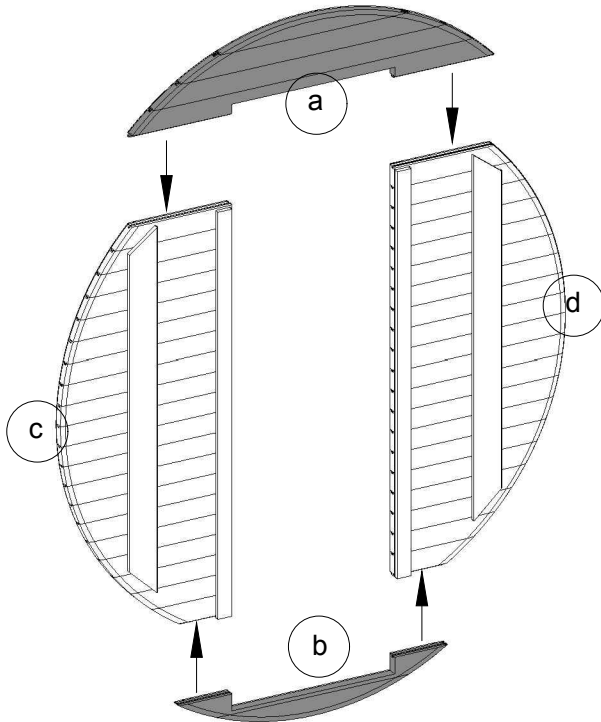

2

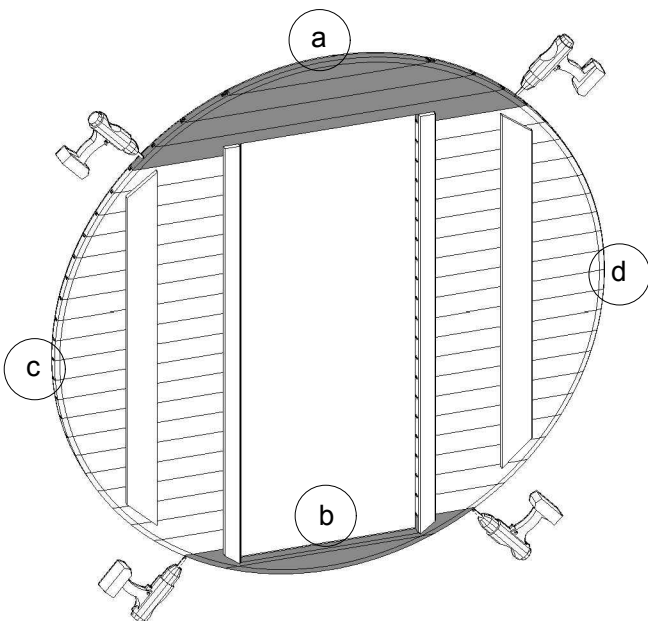

3

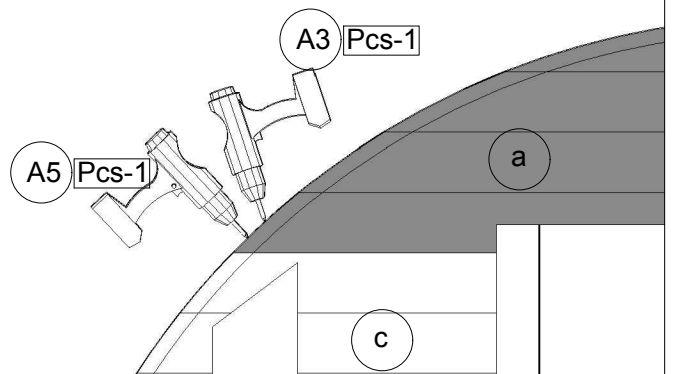

4

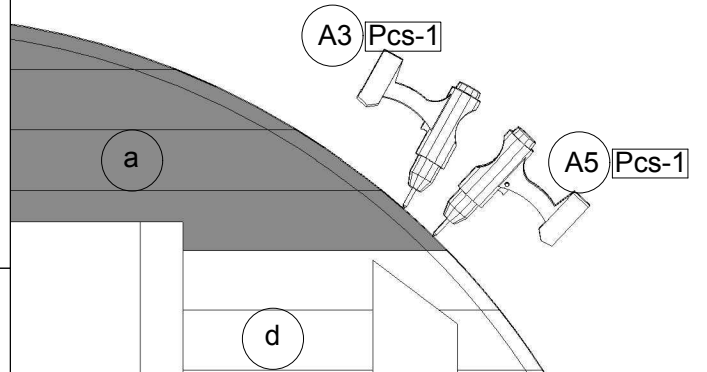

5

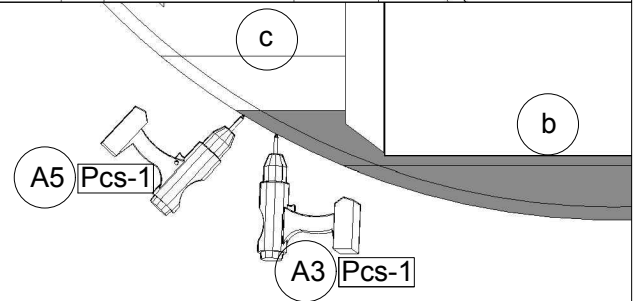

6

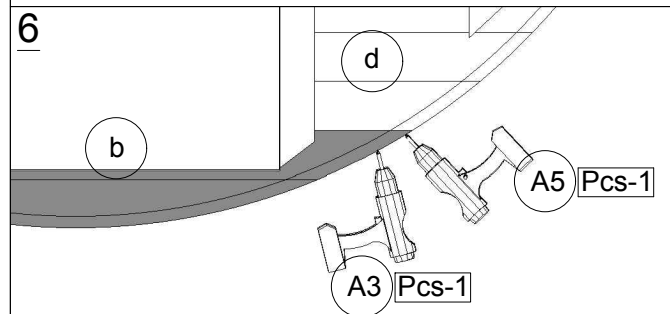

4. Sleeping barrel 4.4 x Ø2.2

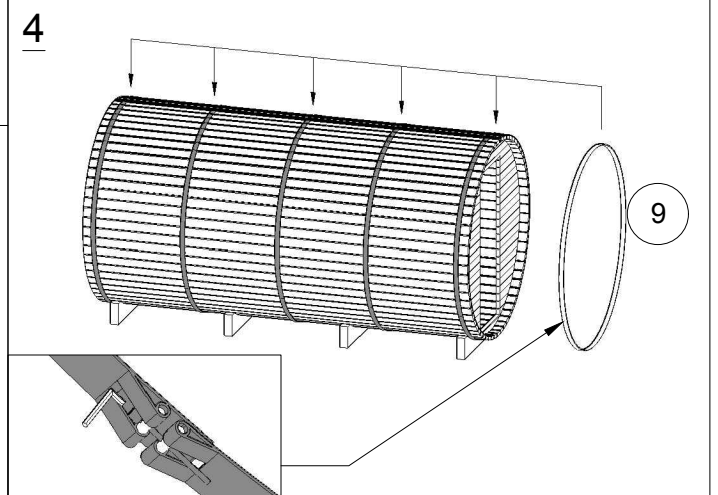
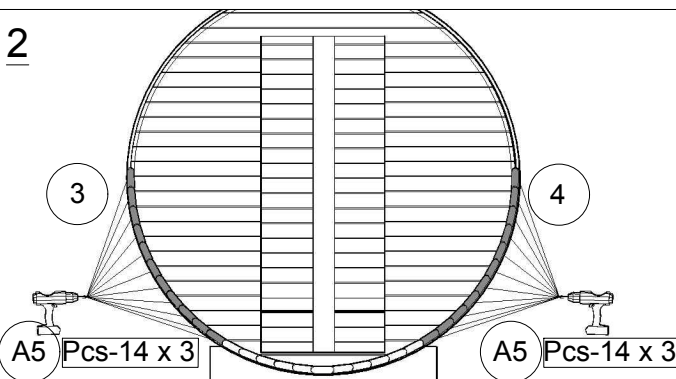
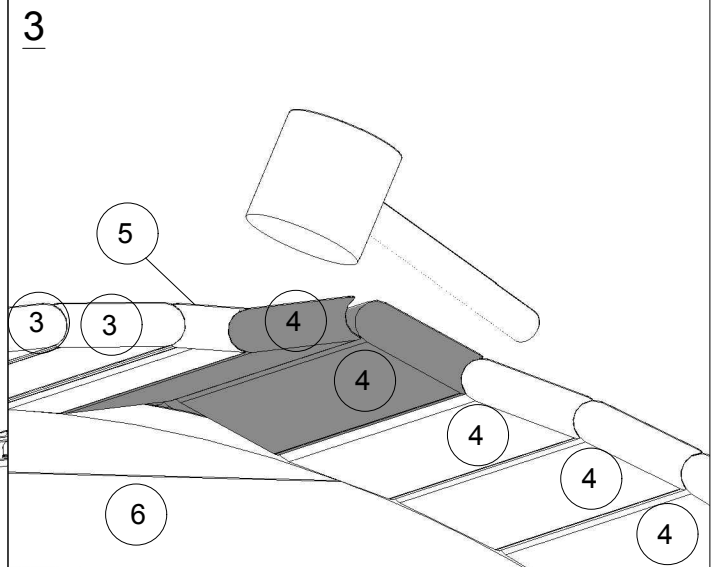
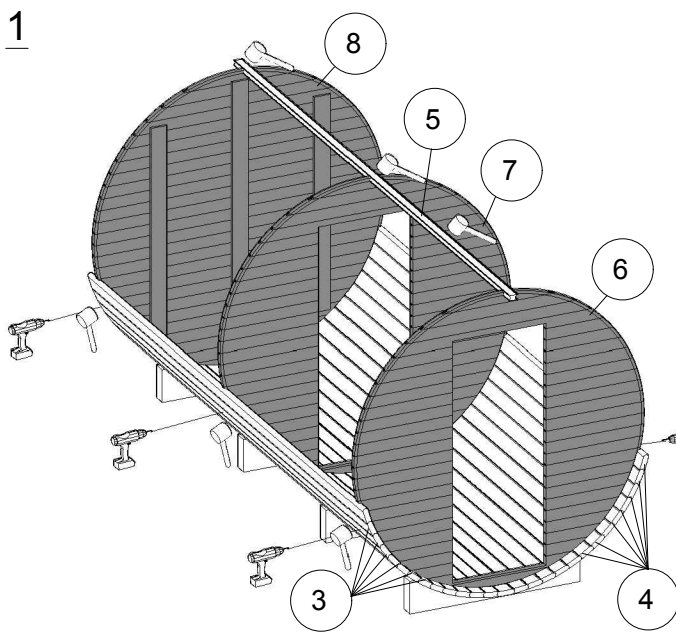
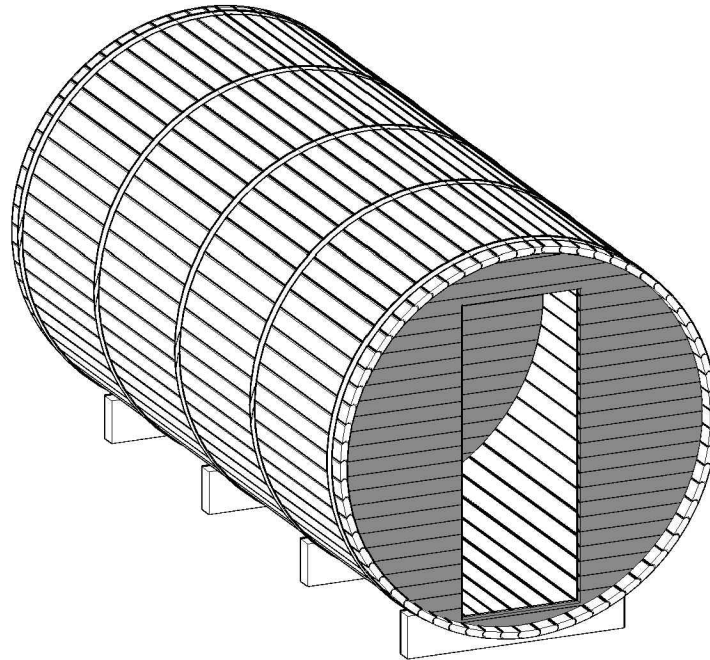

5. Sleeping barrel 4.4 x Ø2.2

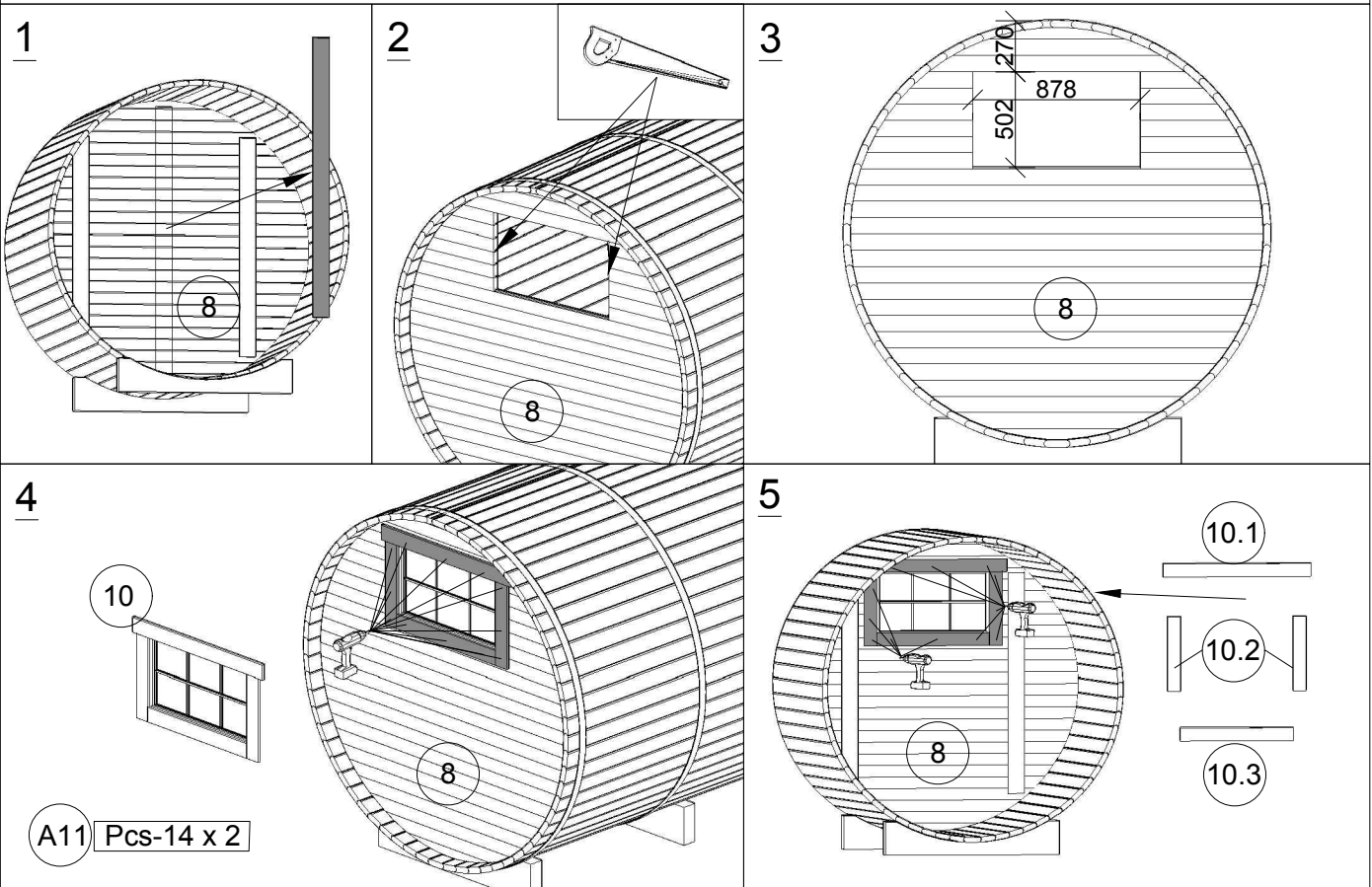
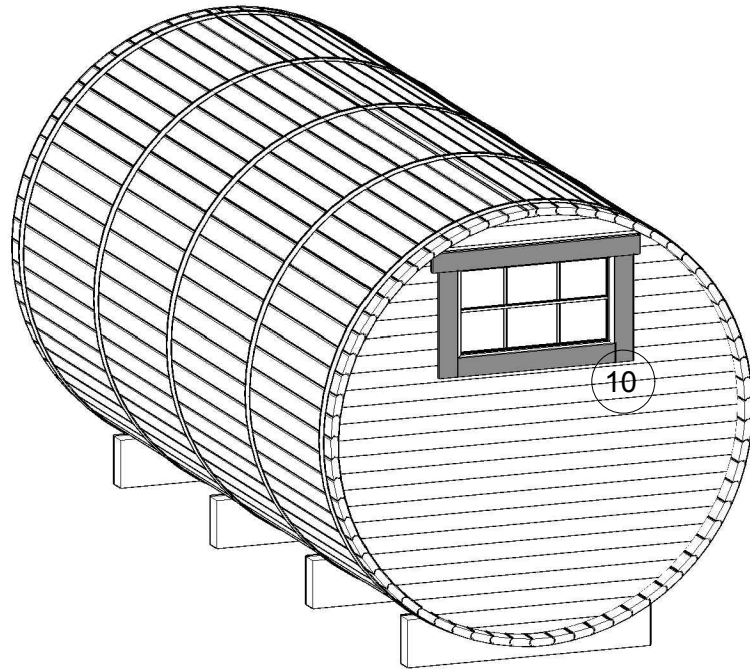

6. Sleeping barrel 4.4 x Ø2.2

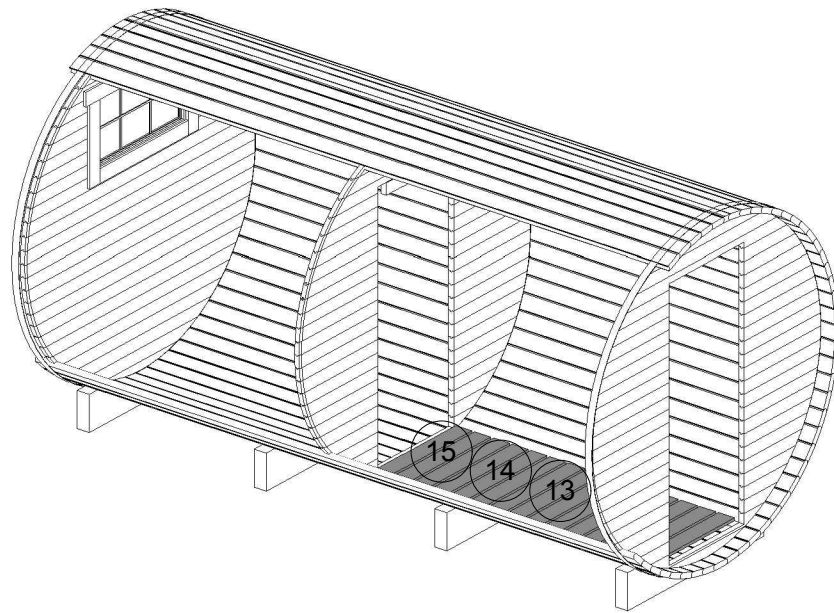

1

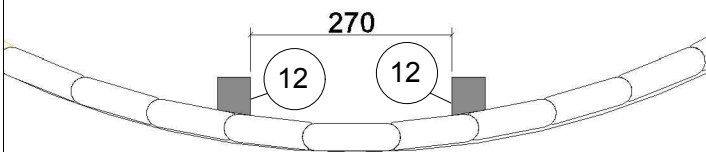

3

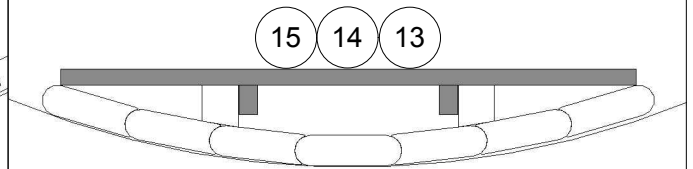

2

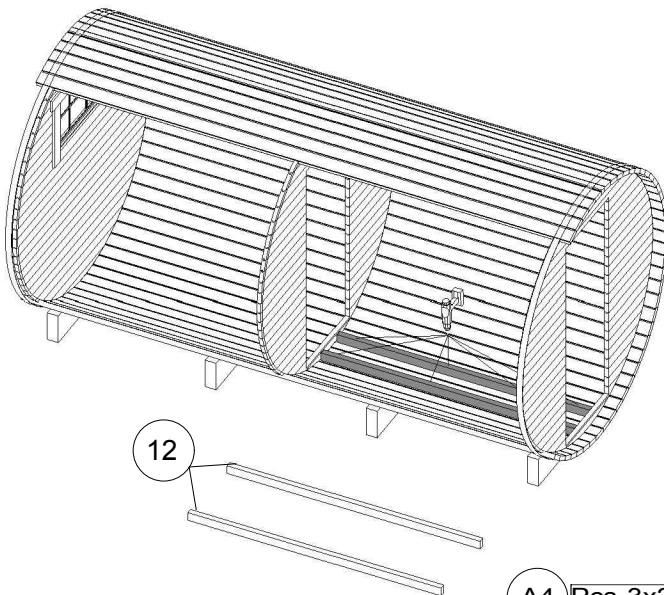

4

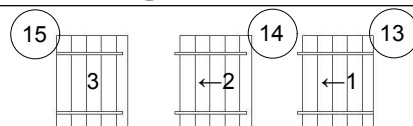
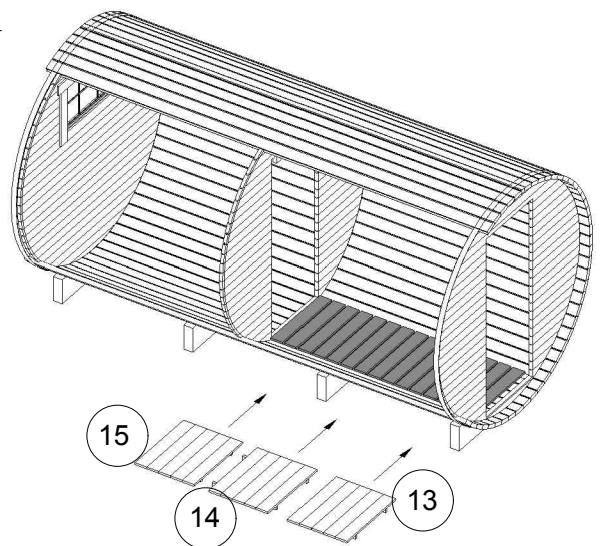

A4 Pcs-3x2

7. Sleeping barrel 4.4 x Ø2.2

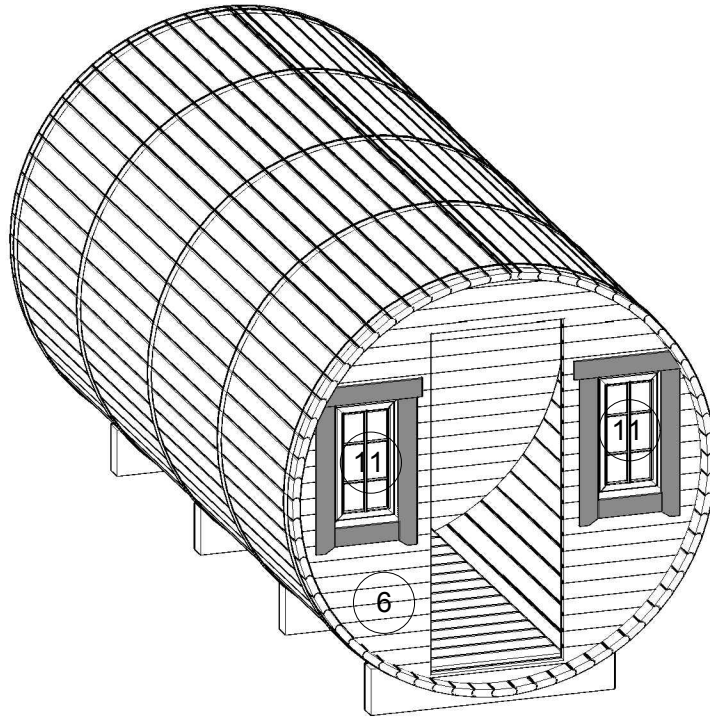

1

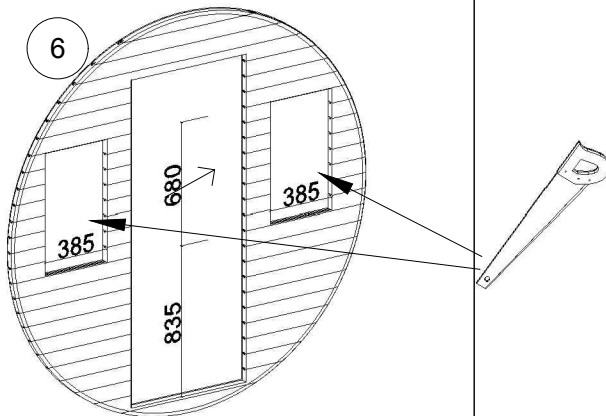

2

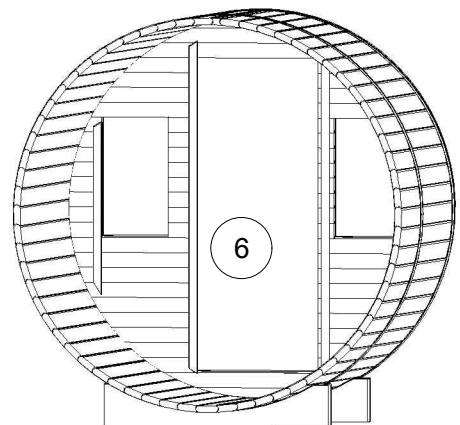

3

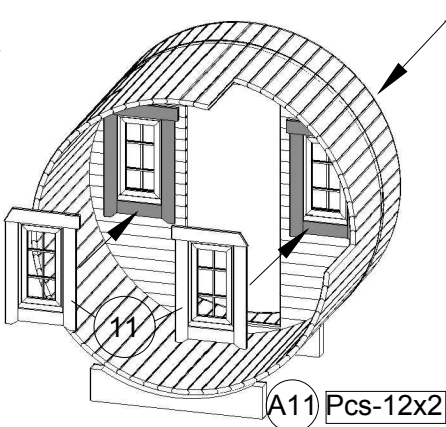

4

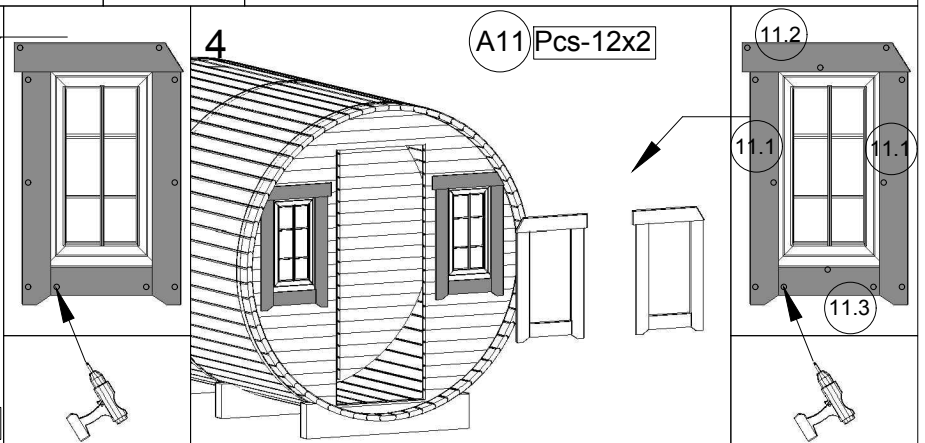

8. Sleeping barrel 4.4 x Ø2.2

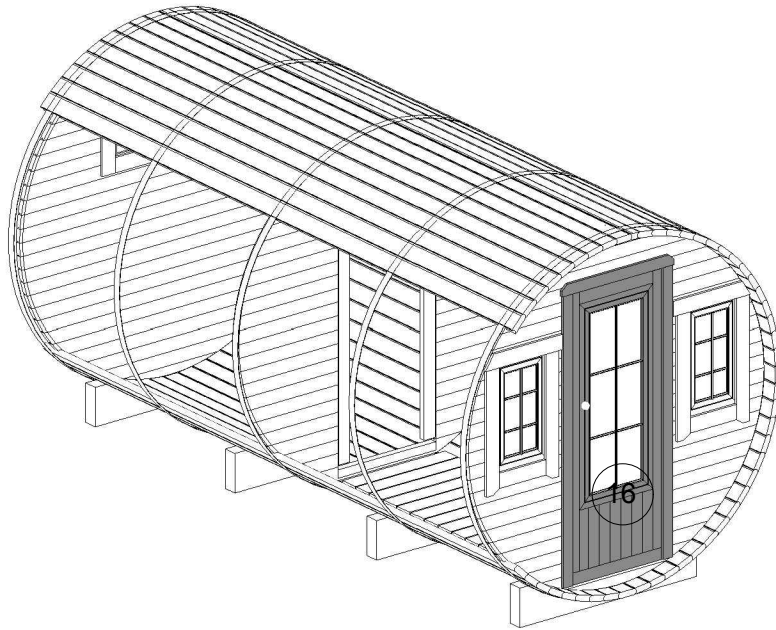

1

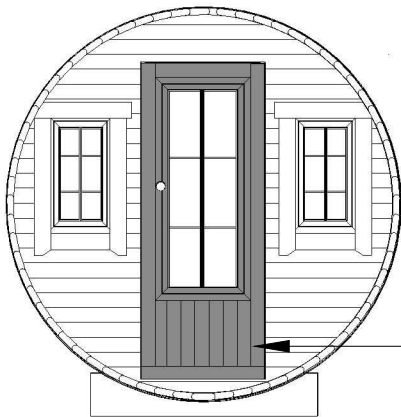

16

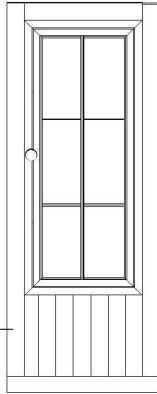

3

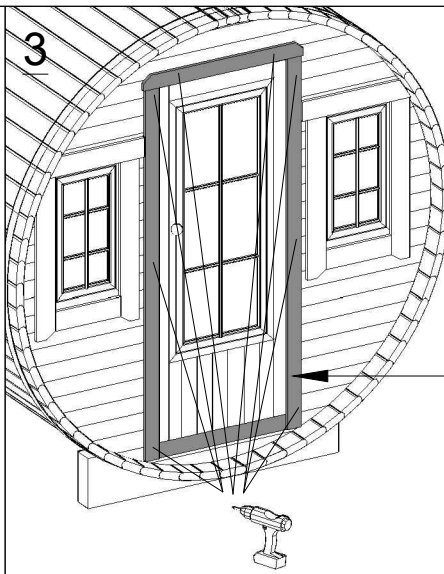

A11 Pcs-28

17

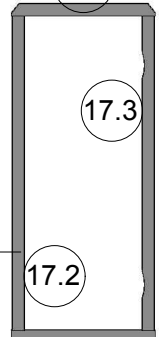

17.2

17.3

17.1

2

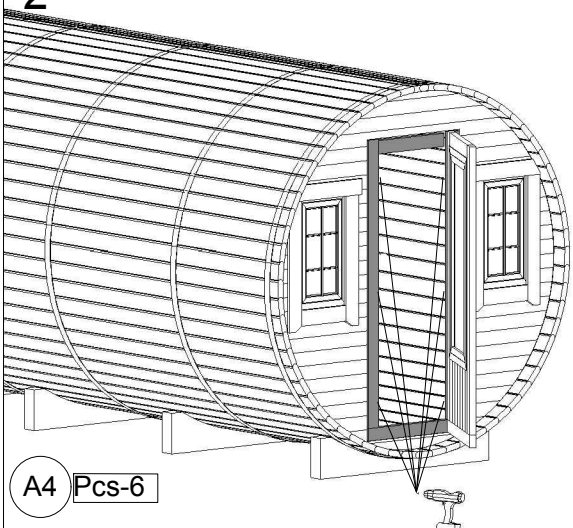

A4 Pcs-6

4

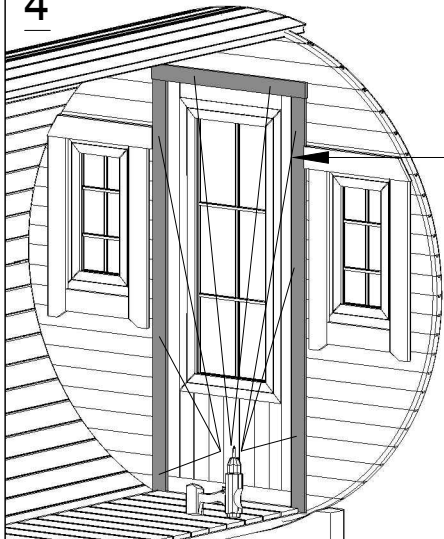

A11 Pcs-22

18

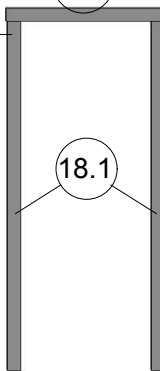

18.1

9. Sleeping barrel 4.4 x Ø2.2

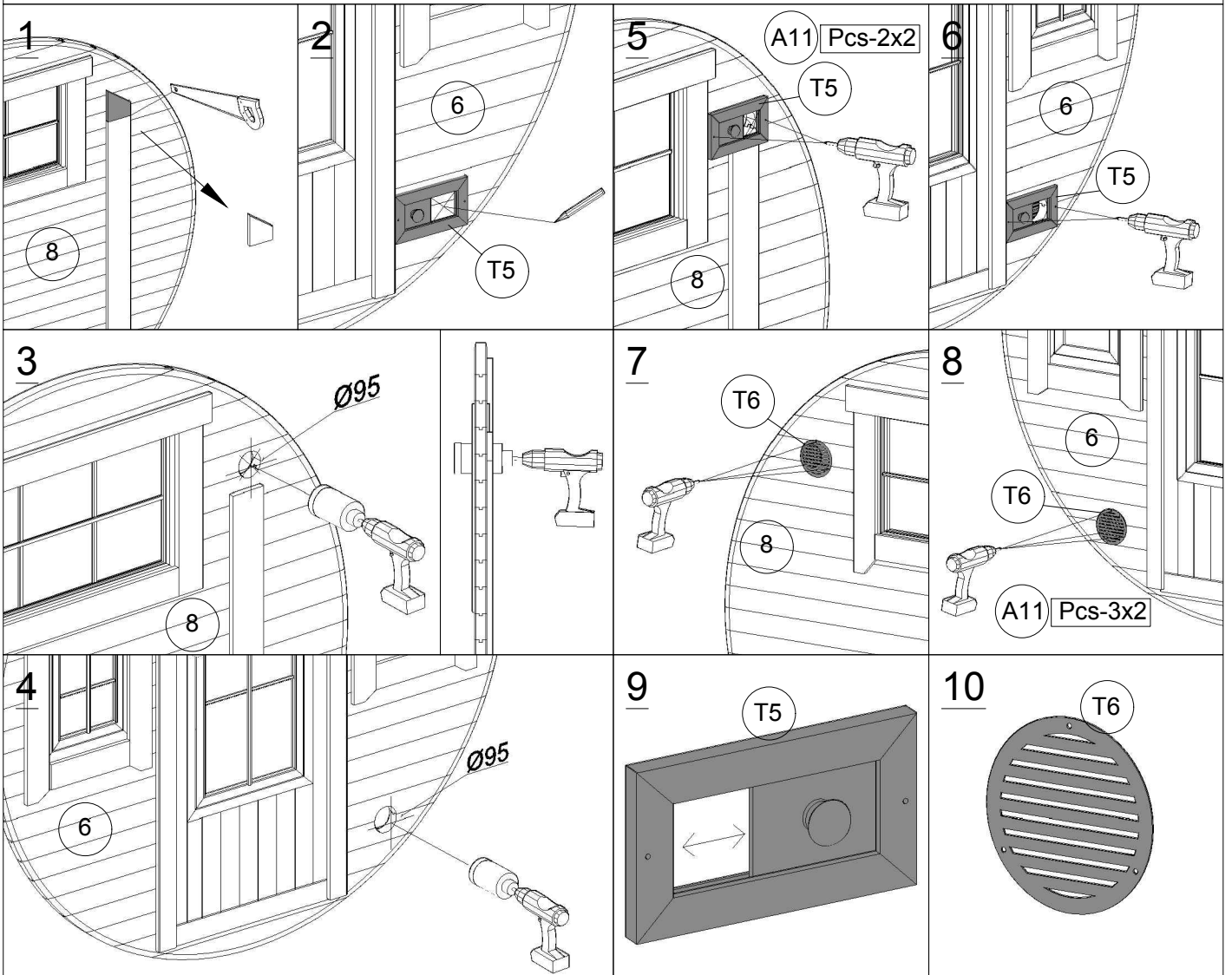
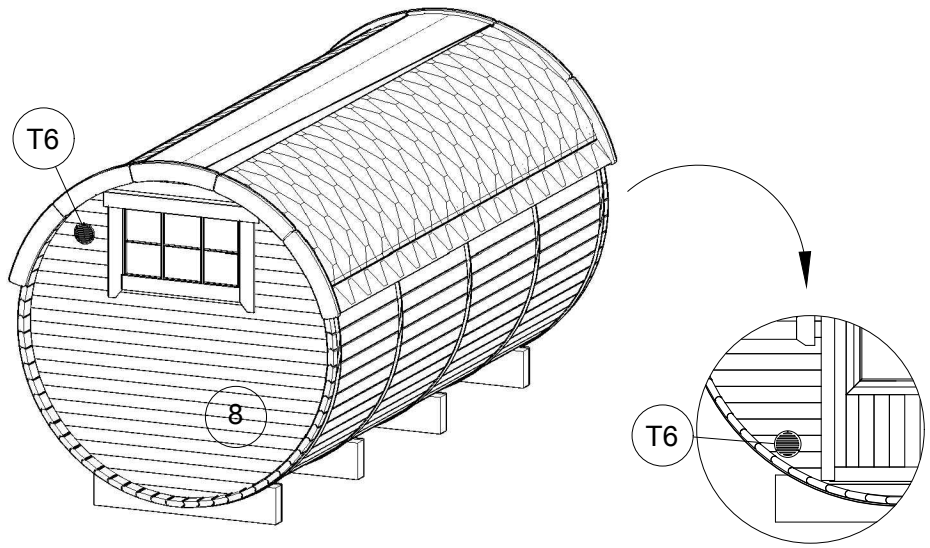

10. Sleeping barrel 4.4 x Ø2.2

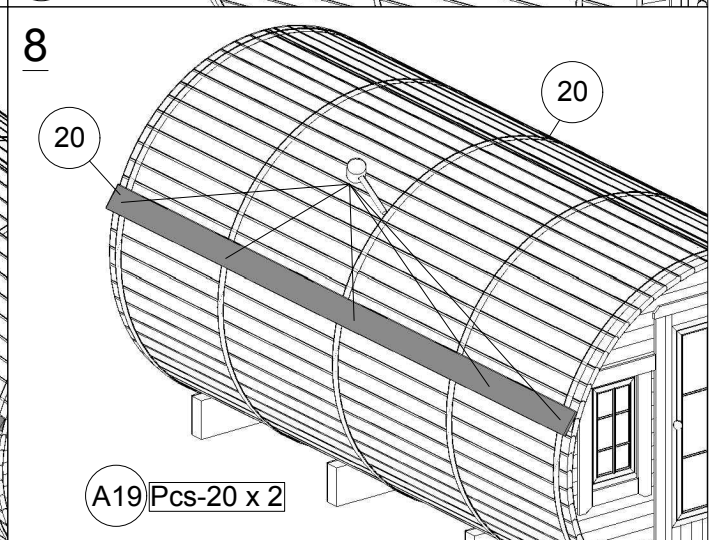
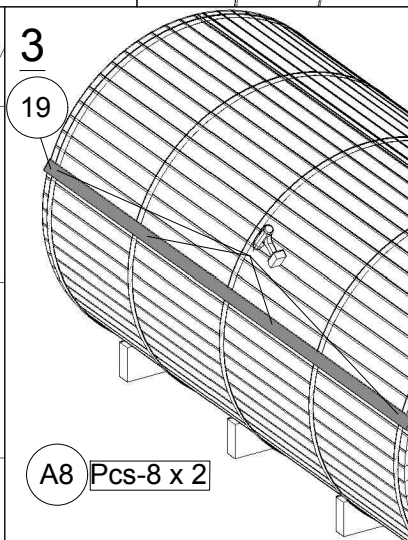
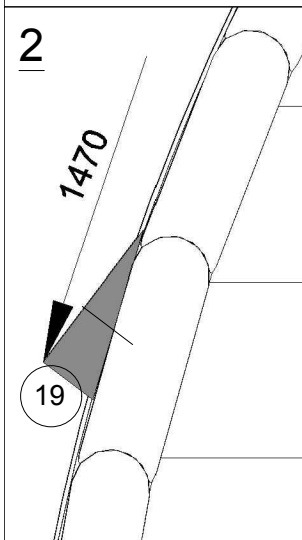
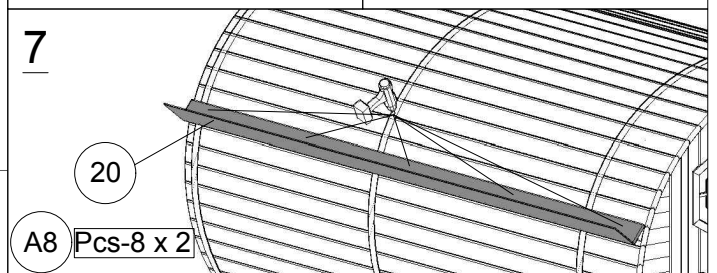
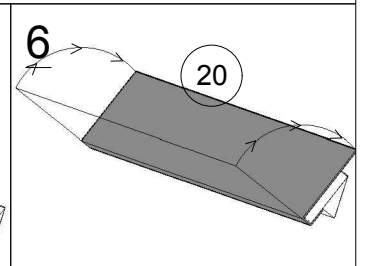
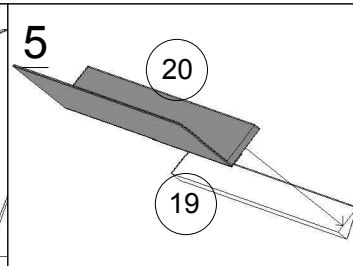
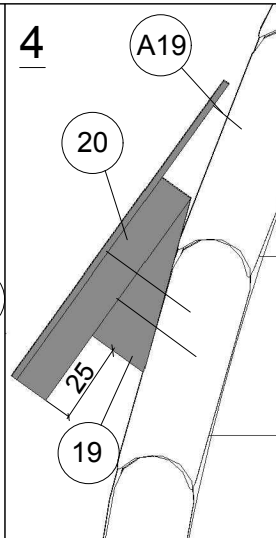
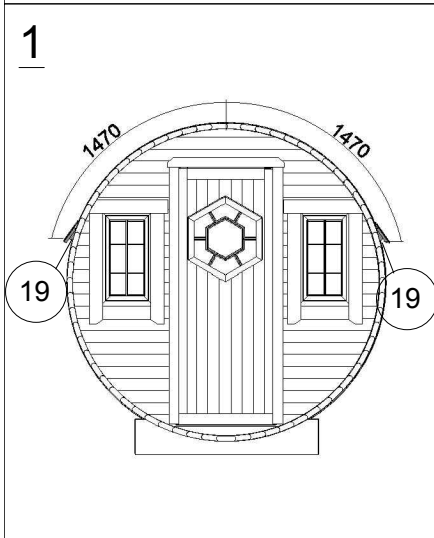
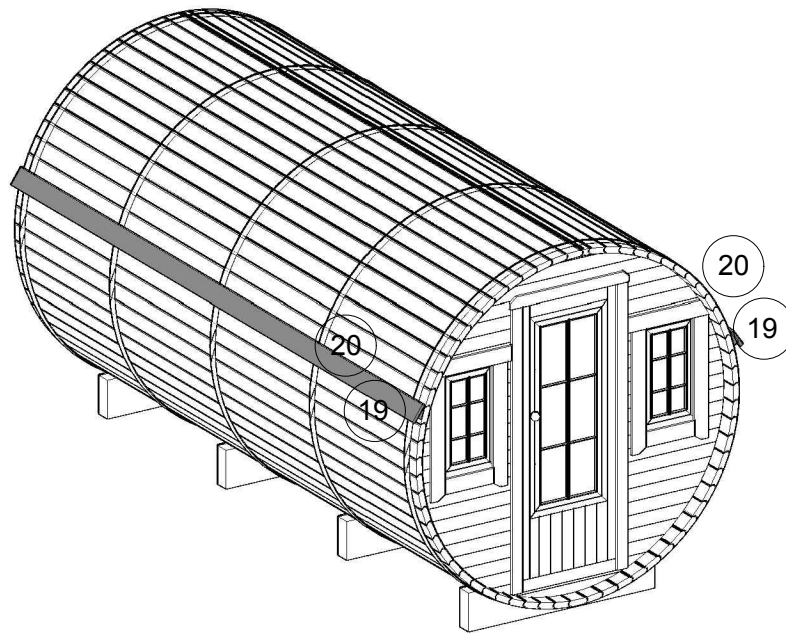

11. Sleeping barrel 4.4 x Ø2.2

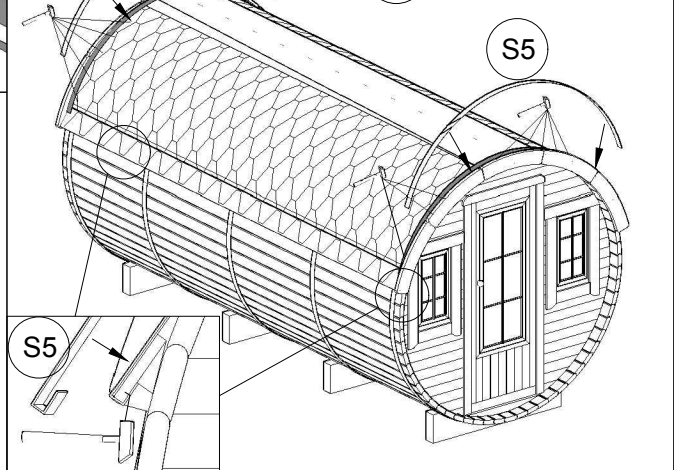
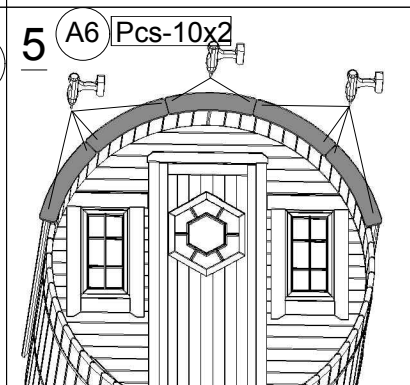
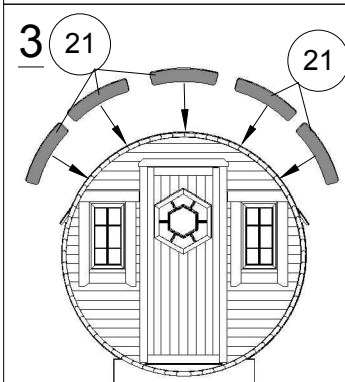
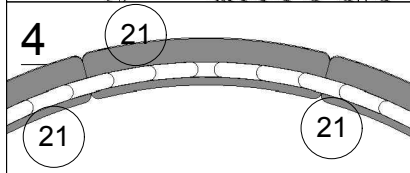
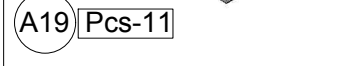
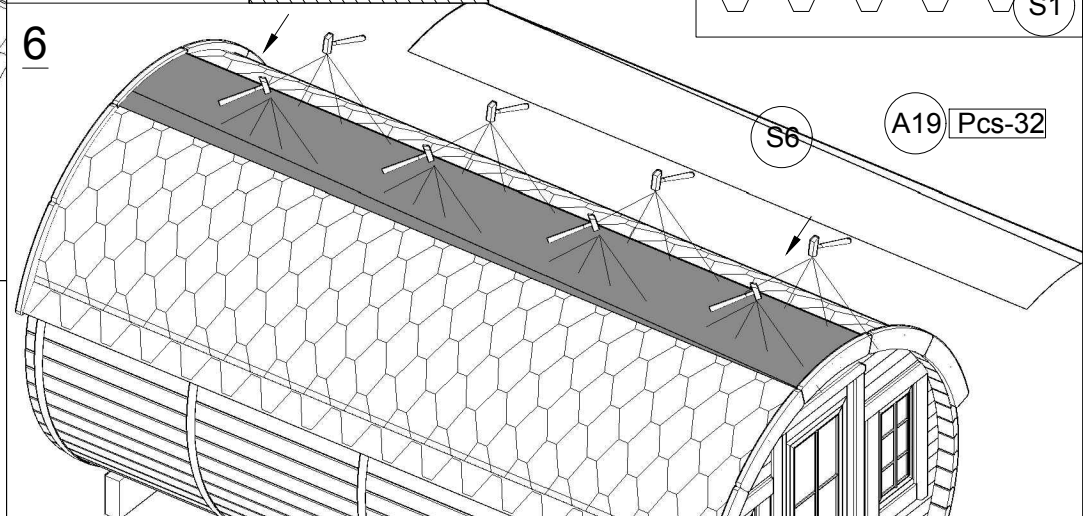
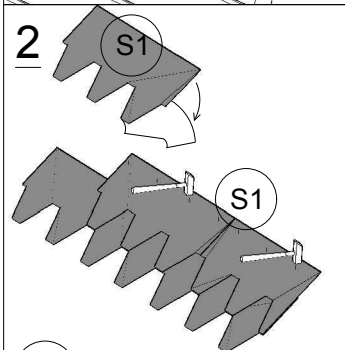
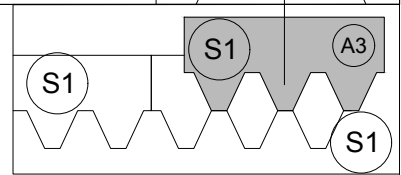
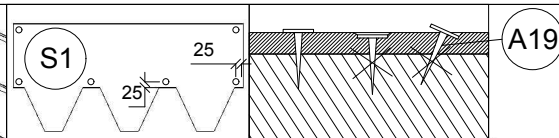
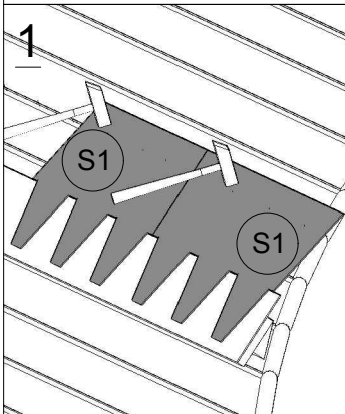
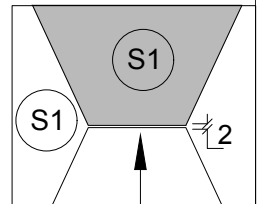
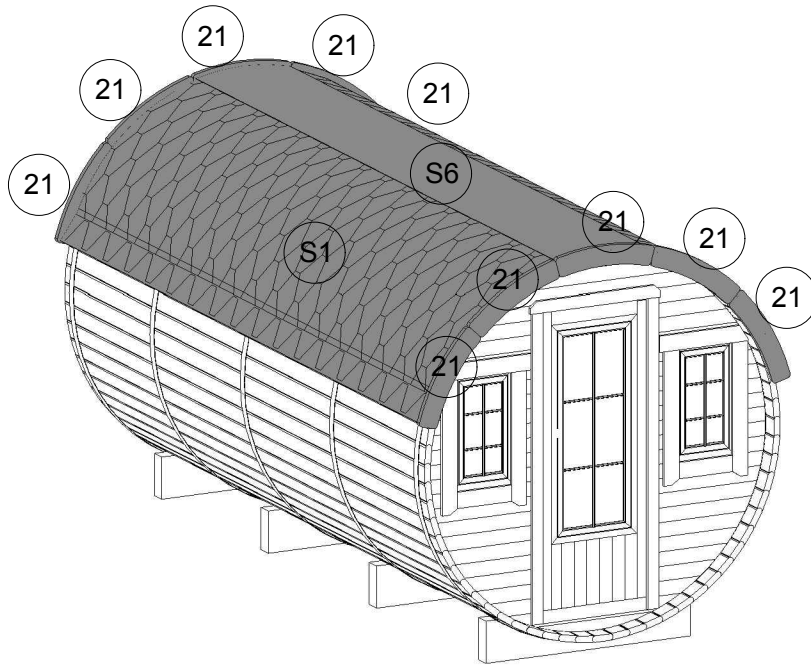

12. Sleeping barrel 4.4 x Ø2.2

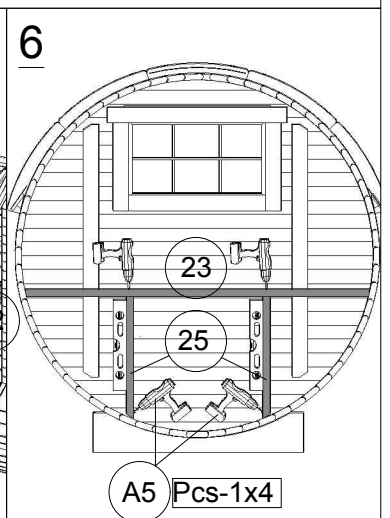
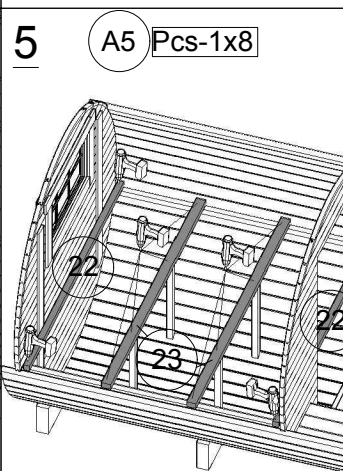
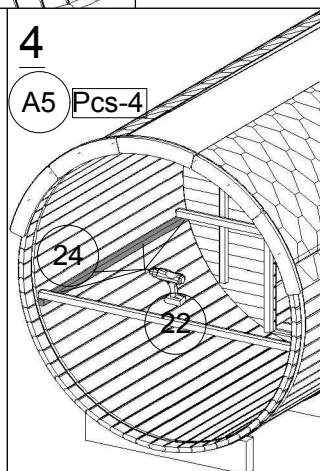
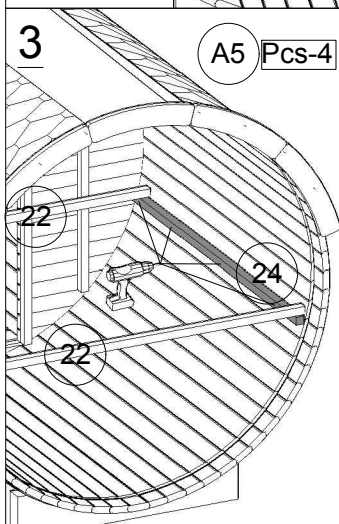
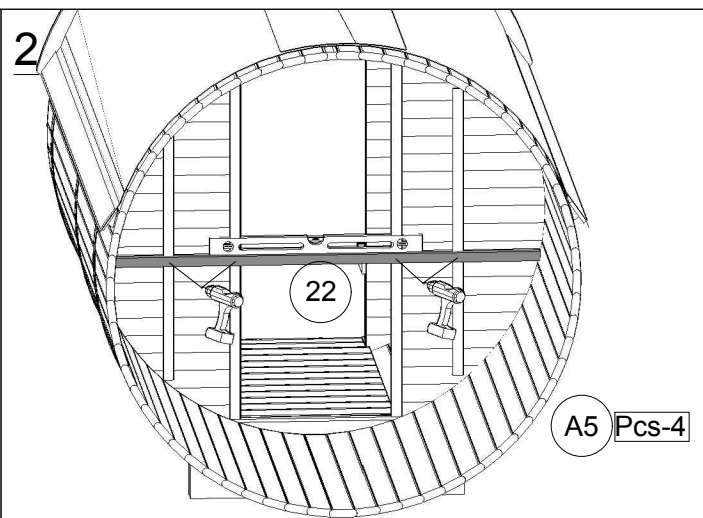
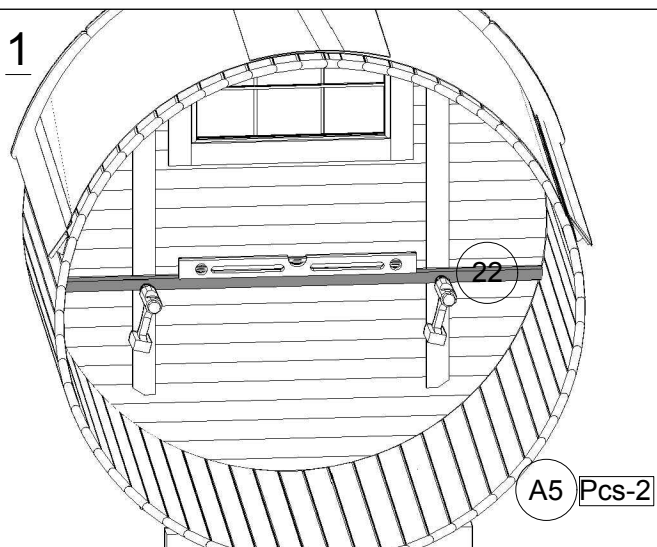
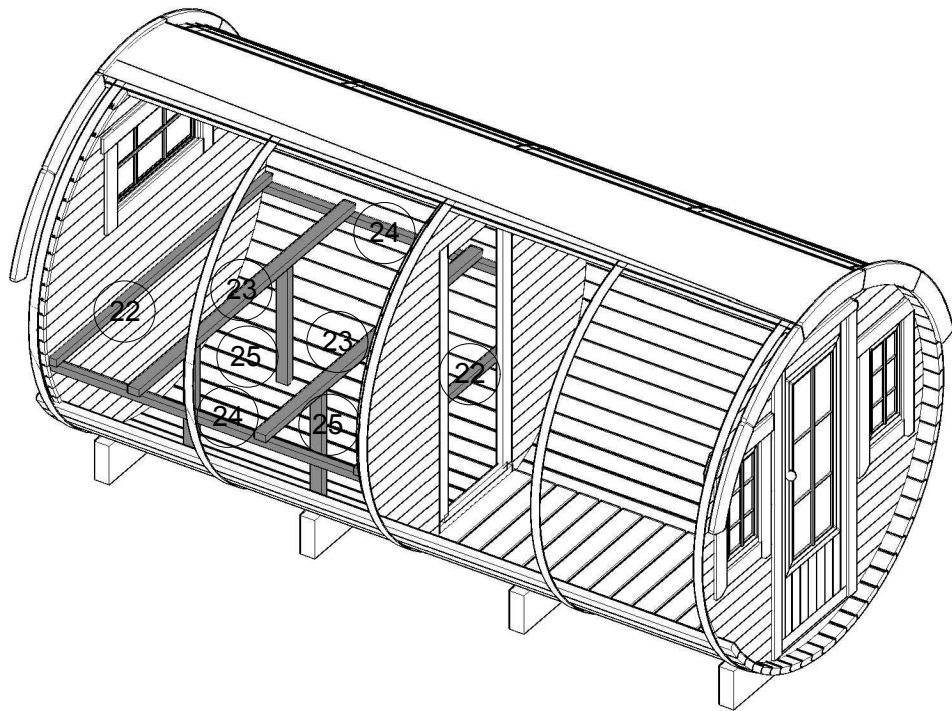

13. Sleeping barrel 4.4 x Ø2.2

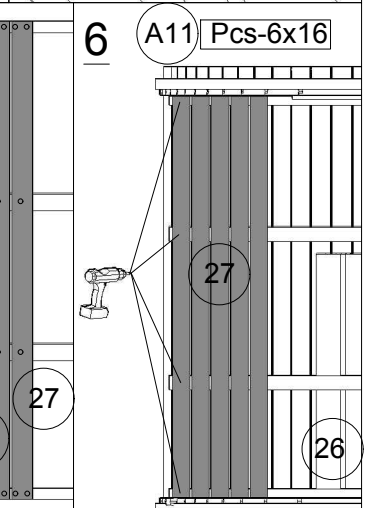
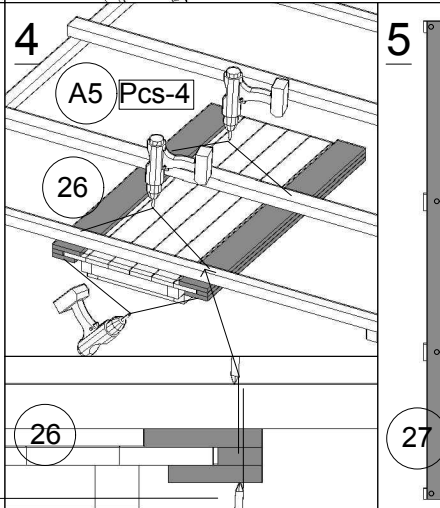
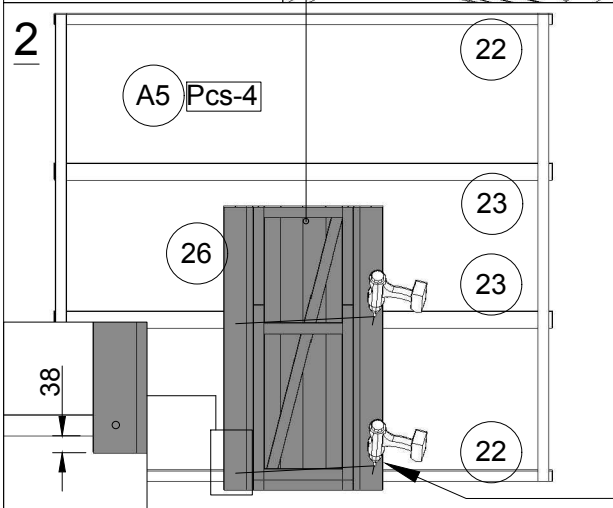
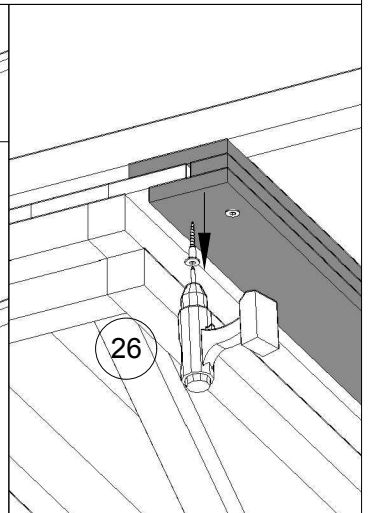
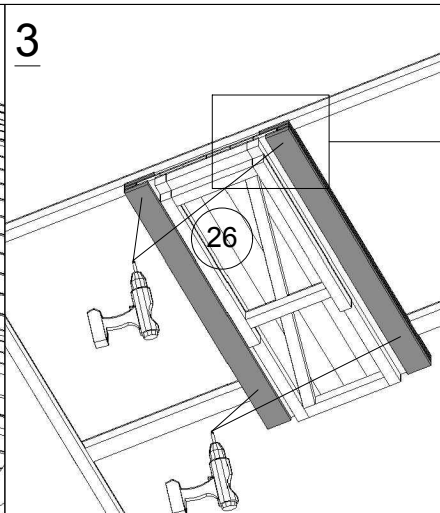
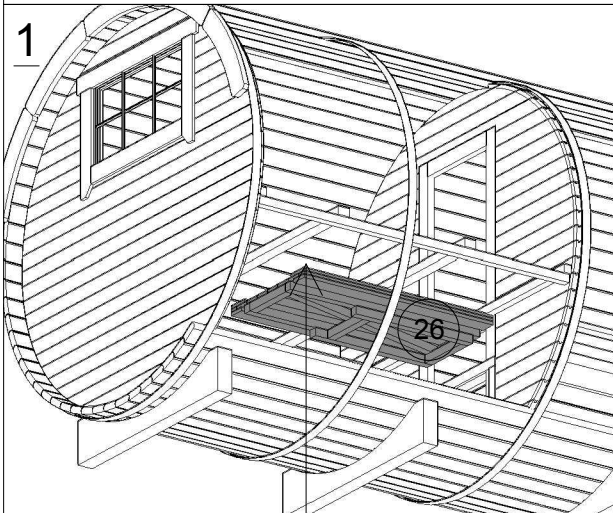
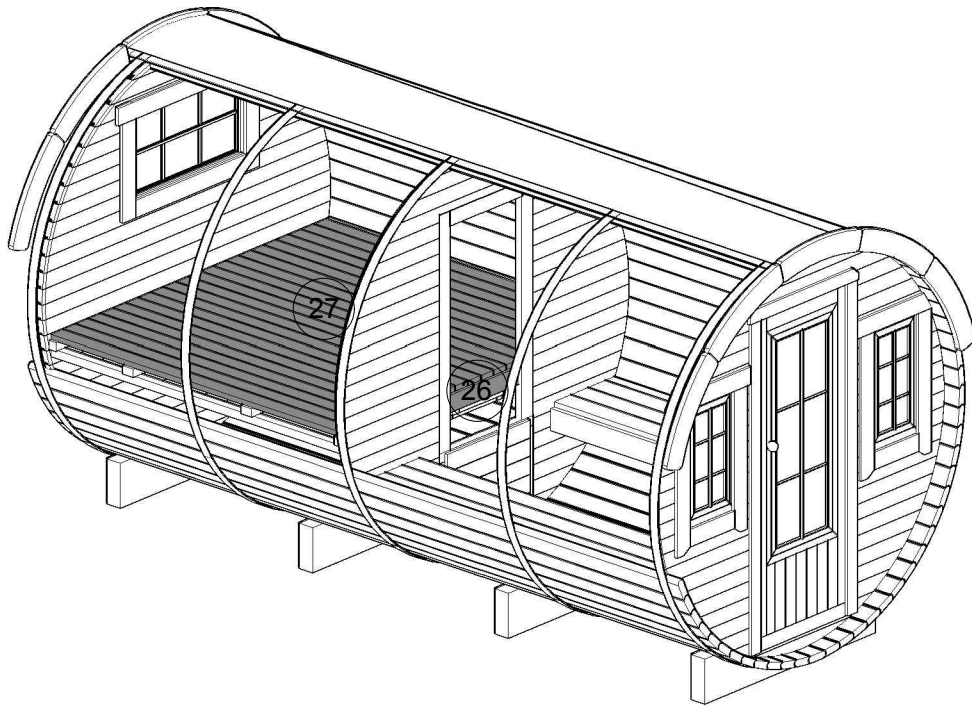

14. Sleeping barrel 4.4 x Ø2.2

