

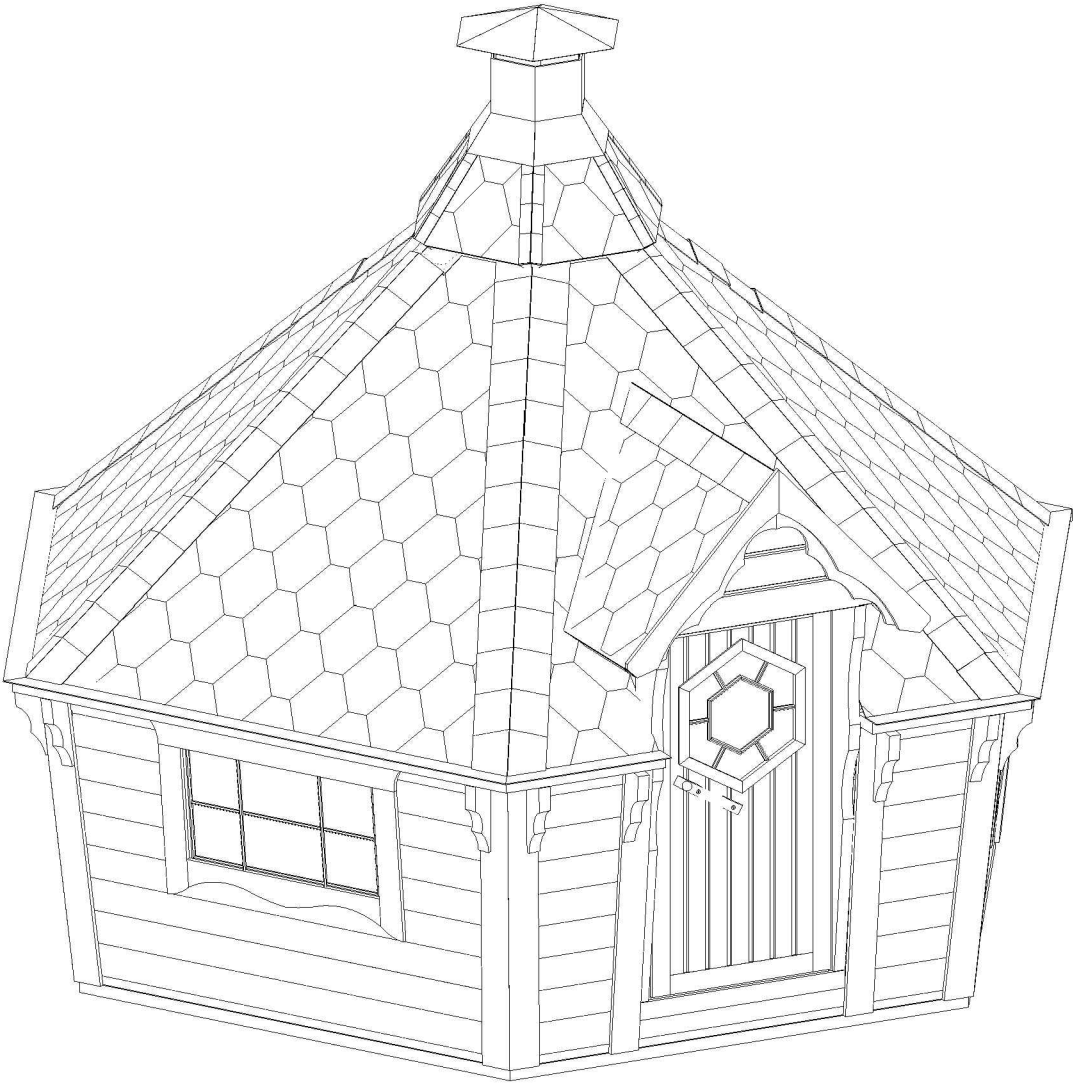

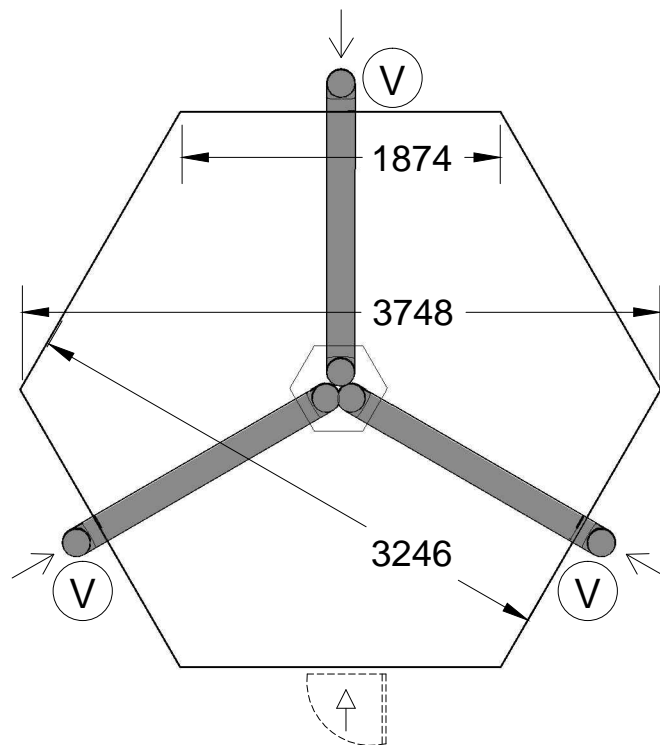

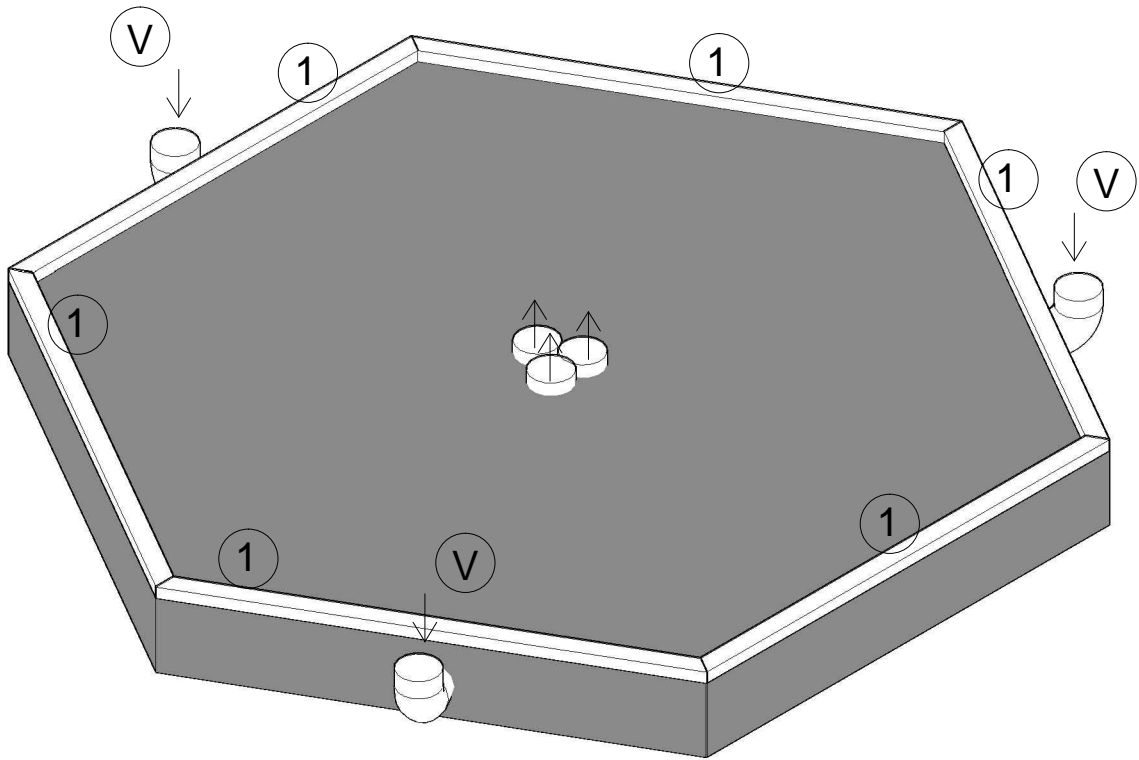





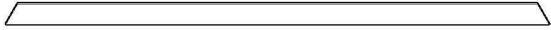

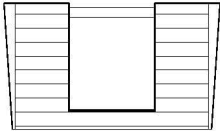
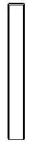
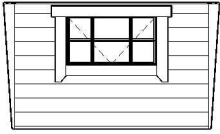
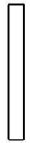
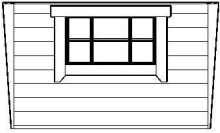
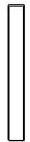
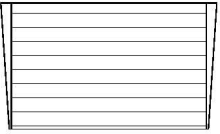
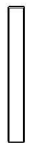
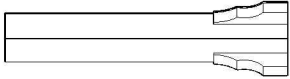

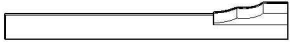

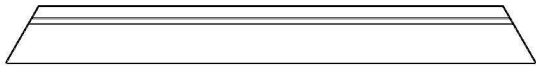

Grill cabin with sloping walls









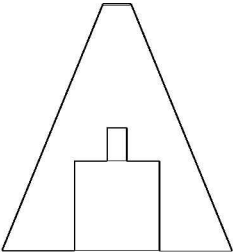
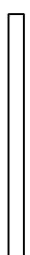
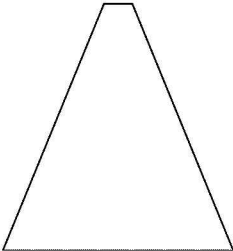
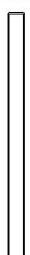





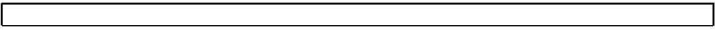

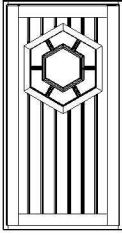



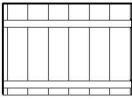

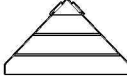

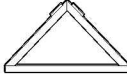



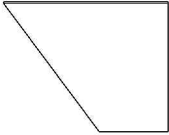

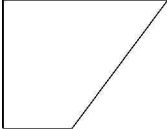

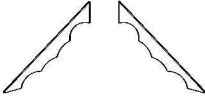

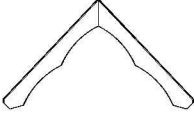

Grill cabin with sloping walls













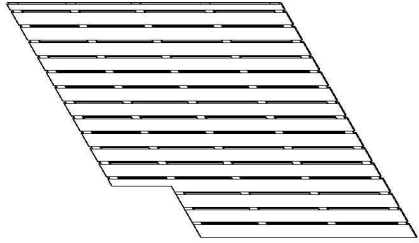

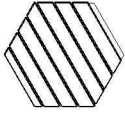

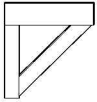
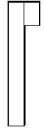

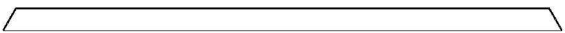



1. Grill cabin with sloping walls

No.	Detail		Pcs	
1			6	
2			1	
3			1	
4			2	
5			2	
6			6	
6.1			1	
6.2			1	
7			5	
8			2	
9			6	
10			5	
11			2	
12			1	
13			5	

2. Grill cabin with sloping walls

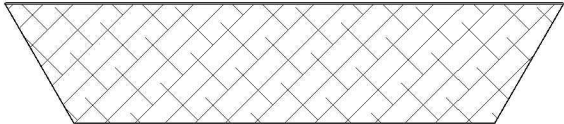
No.	Detail		Pcs	
14			6	
15			6	
16			1	
17			2	
18			1	
19			1	
20			1	
21			2	
22			1	
23			1	
24			2	
25			2	
26			1	
26.1			1	
27			2	
28			2	
29			6	

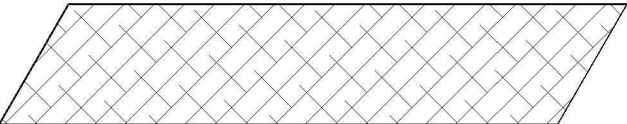
3. Grill cabin with sloping walls

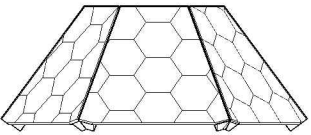
No.	Detail		Pcs	
30			3	
31			1	
30			15	
31			2	9.2 SKS 1
32			2	9.2 SKS 2
33			1	9.2 SKS 3
34			3	9.2 SL 2
35			3	9.2 SL 3
36			4	9.2 SL 1
37			3	
38			2	
39			1	

1. Grill cabin with sloping walls

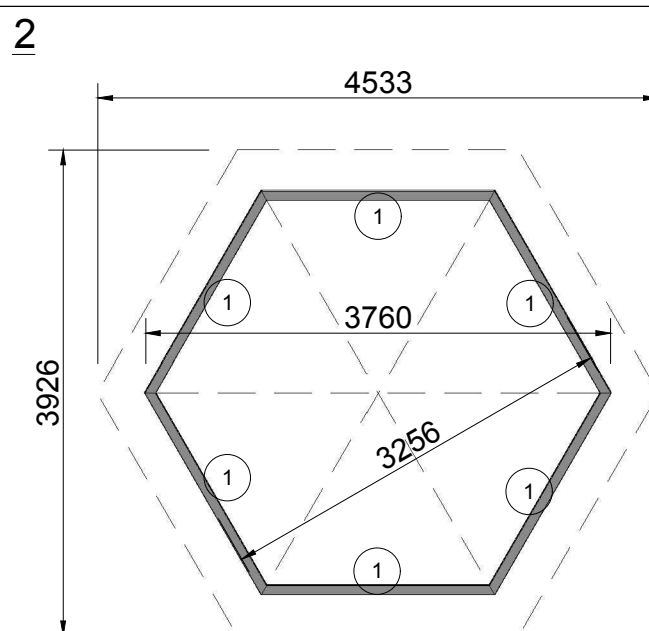
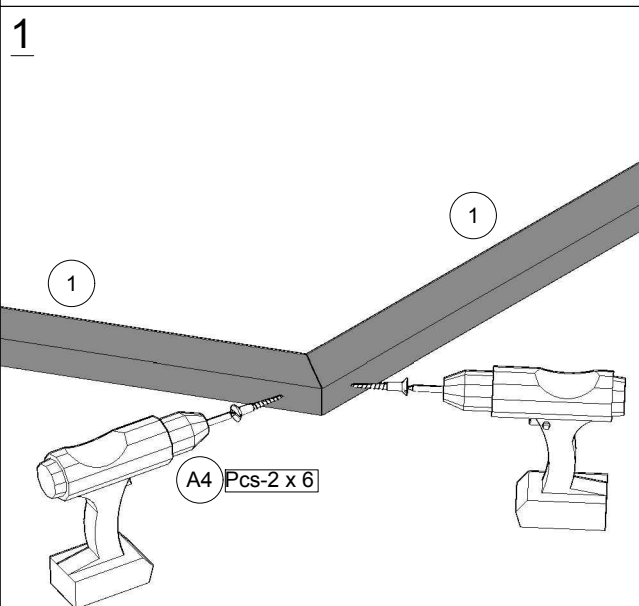
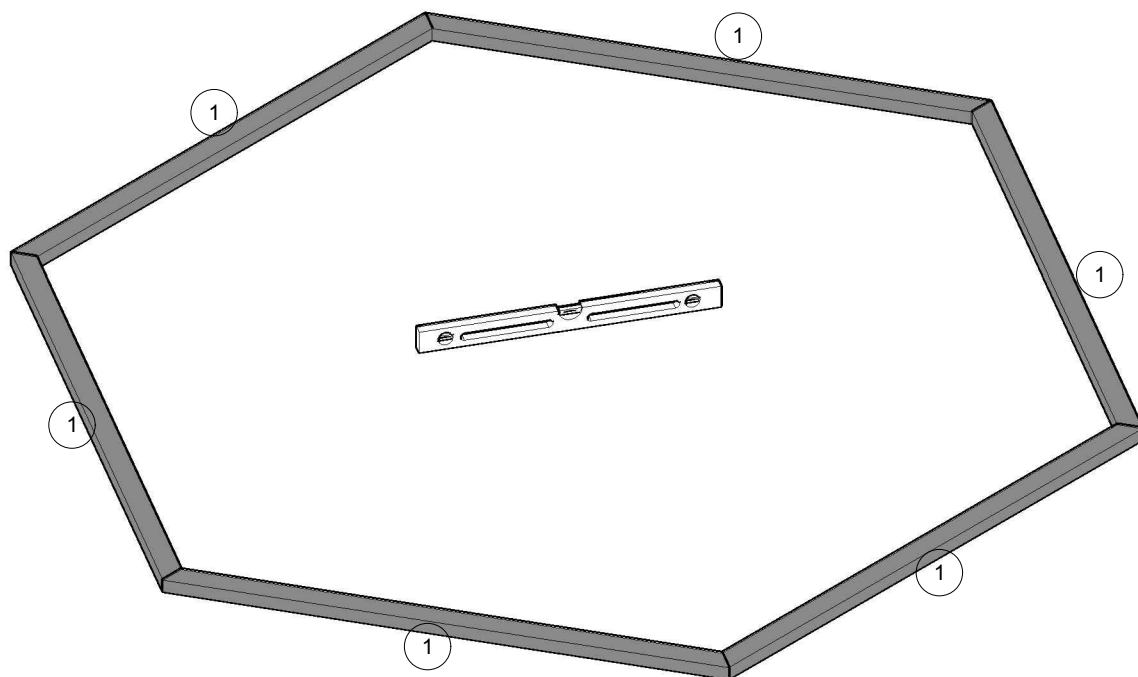

2. Grill cabin with sloping walls

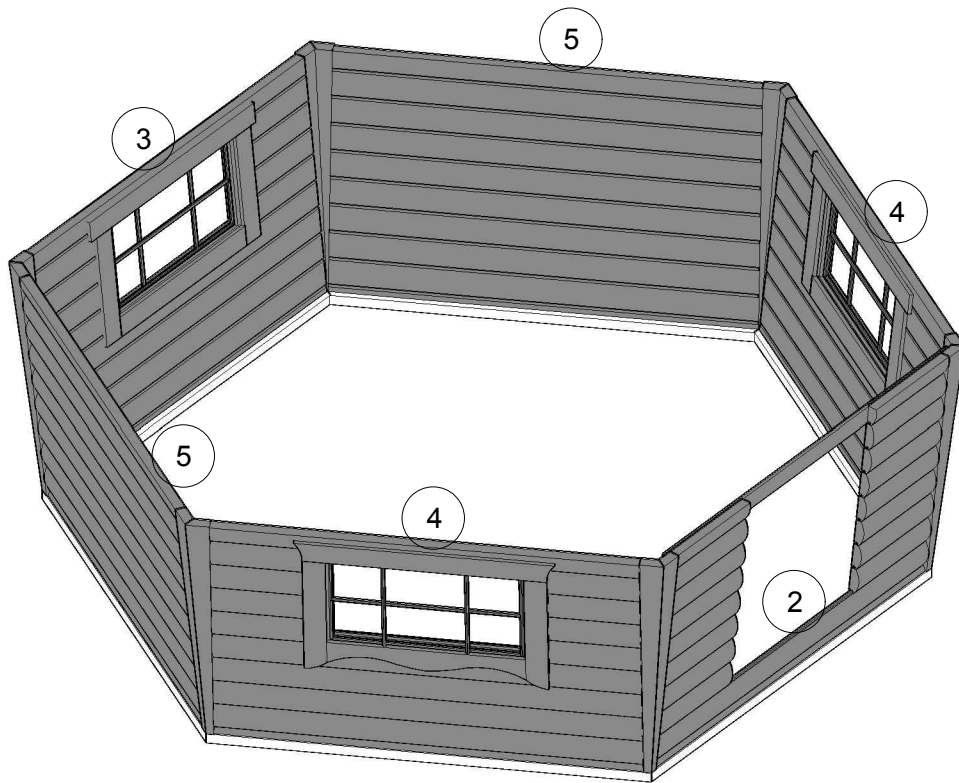

1

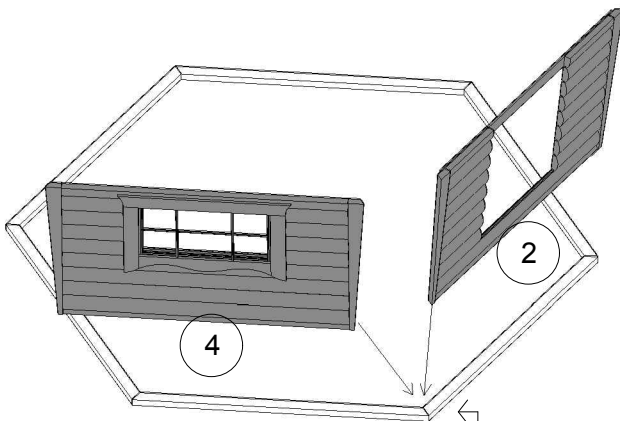

2

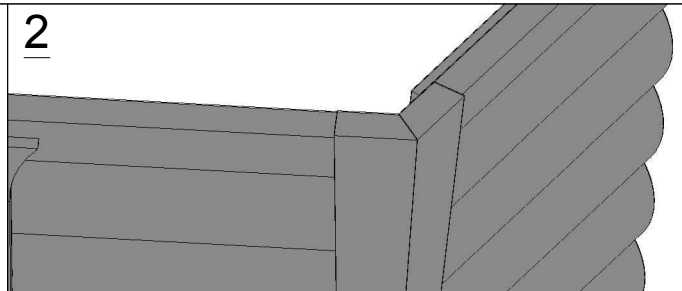

3

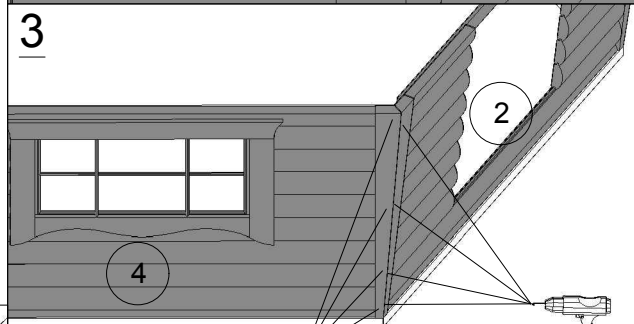

A5 Pcs- 8 x 6

3. Grill cabin with sloping walls

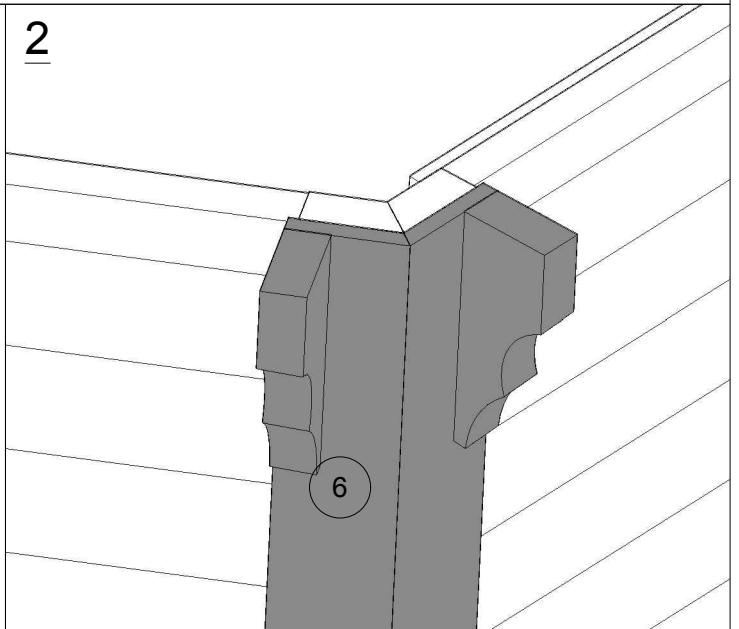
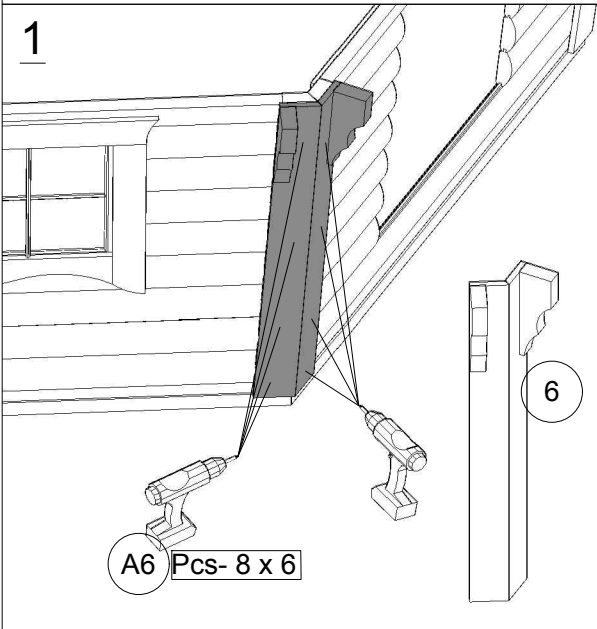
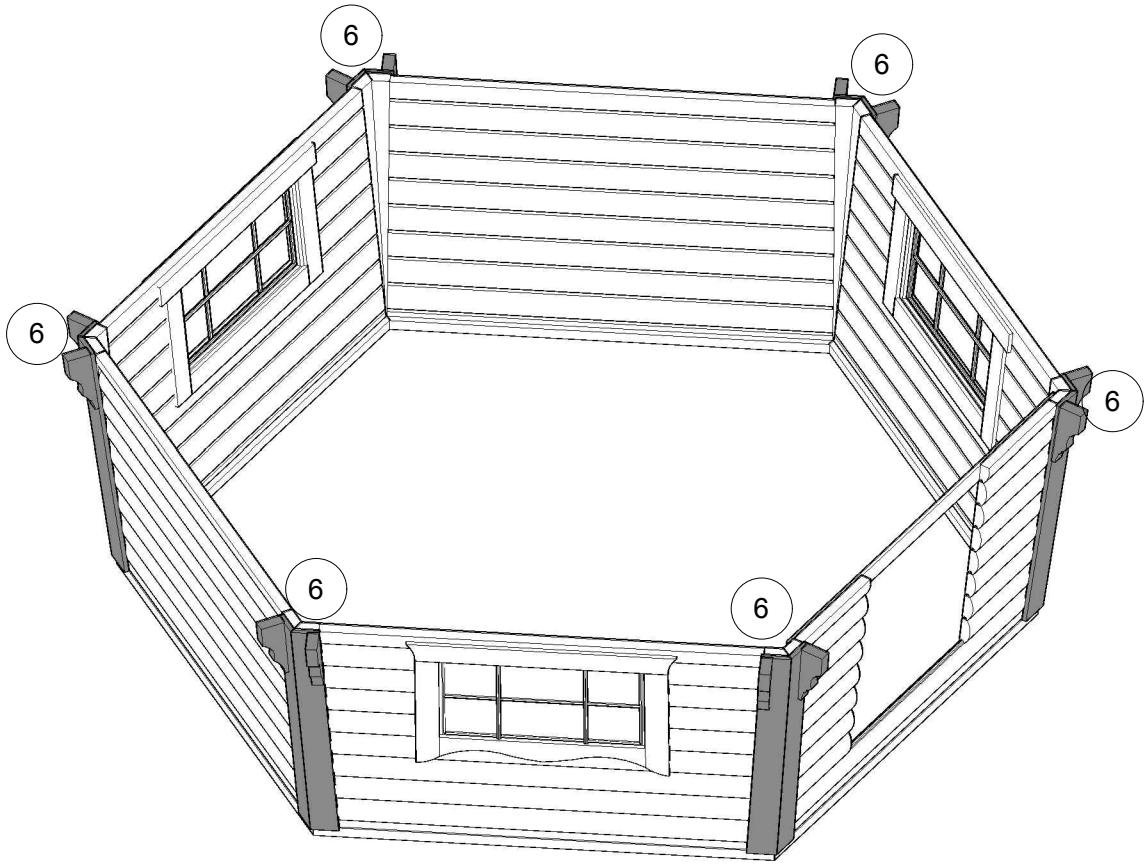

4. Grill cabin with sloping walls

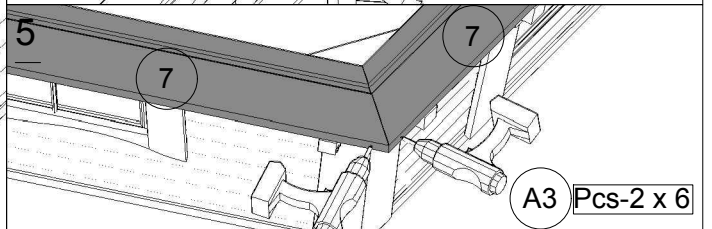
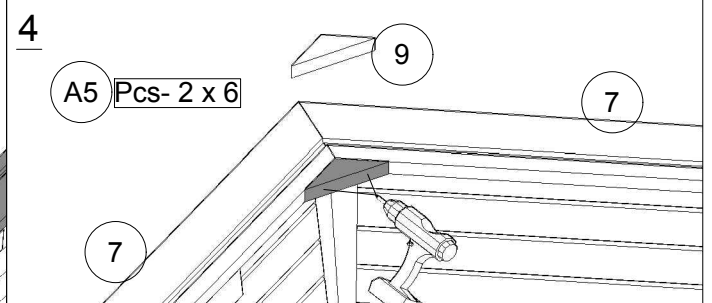
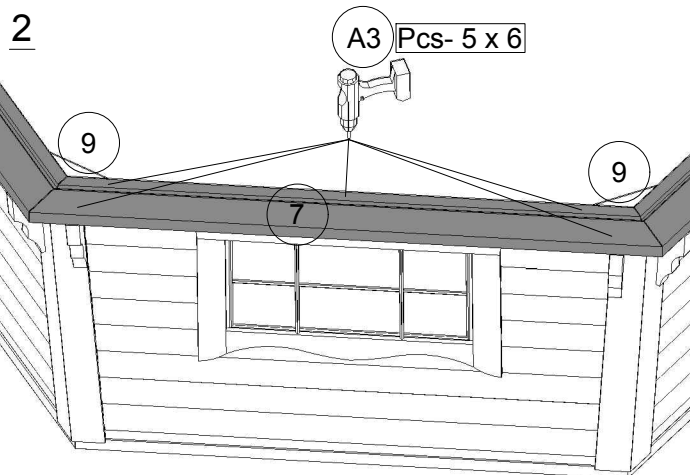
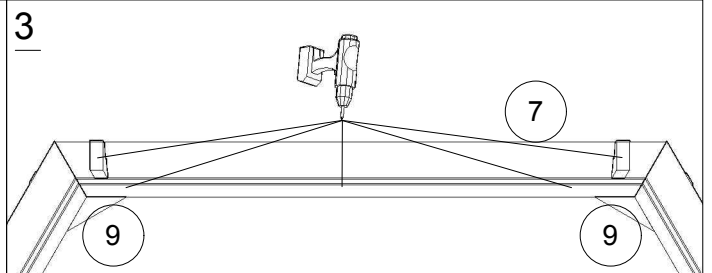
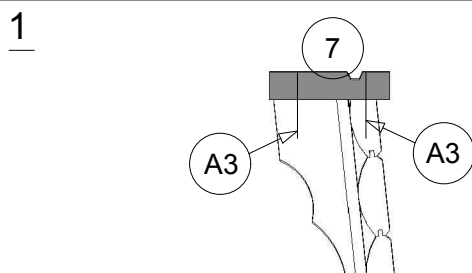
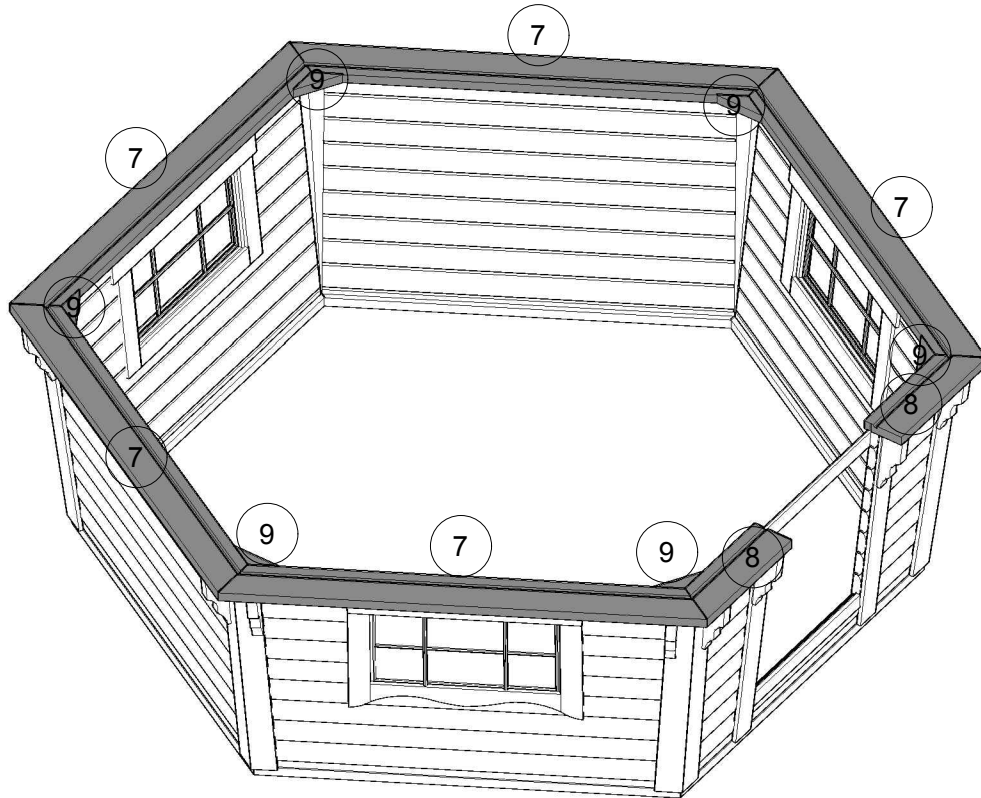

5. Grill cabin with sloping walls

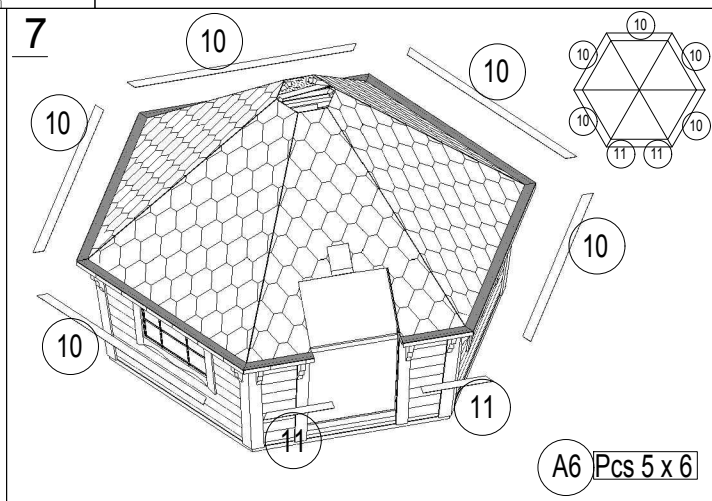
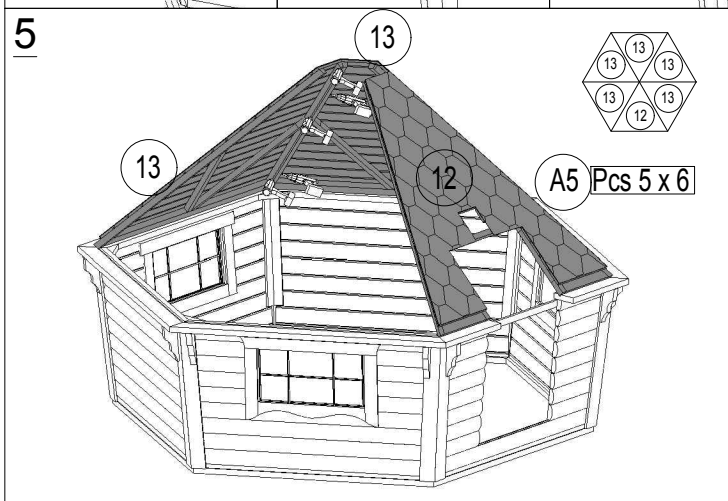
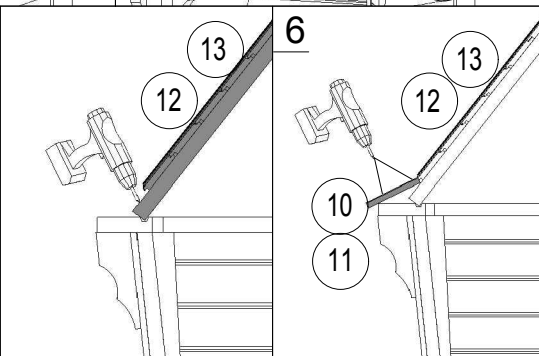
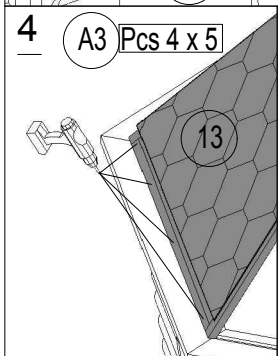
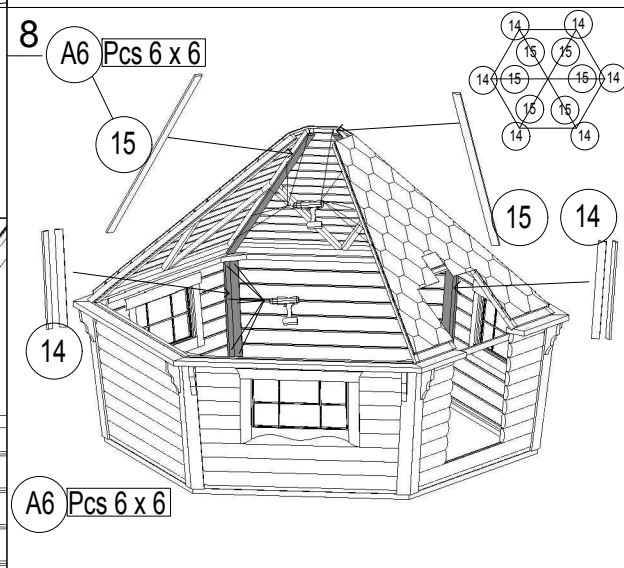
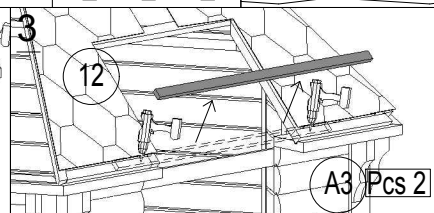
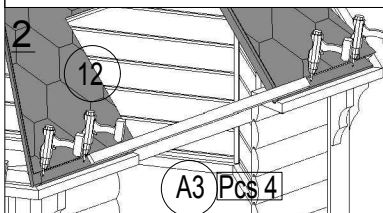
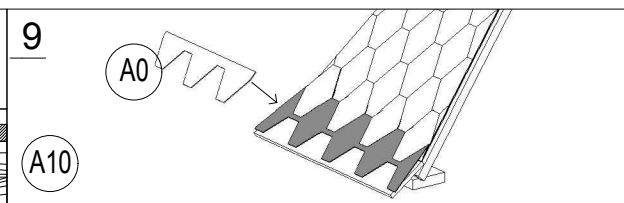
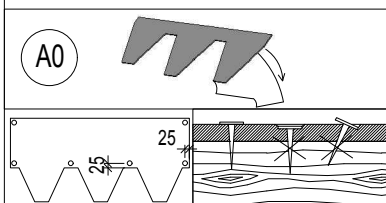
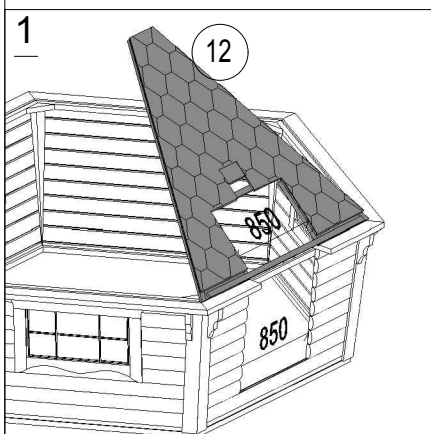
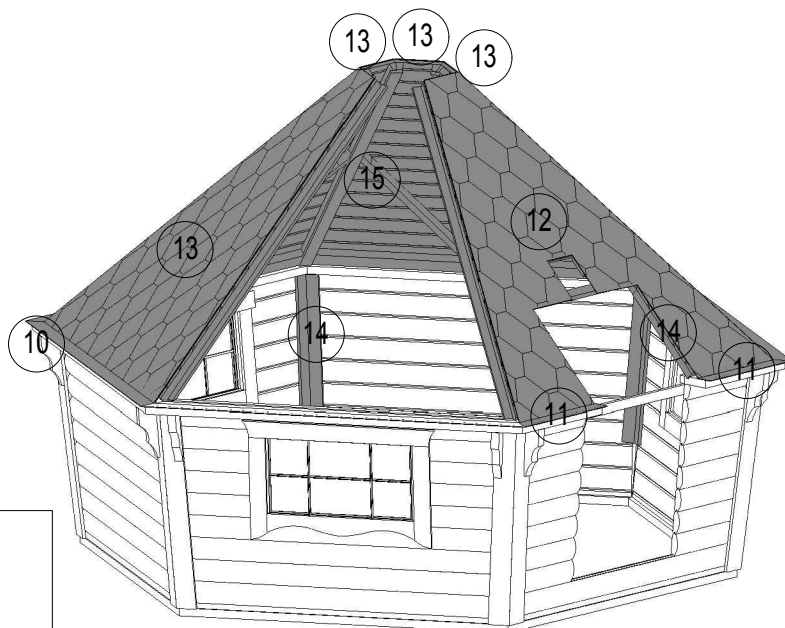

6. Grill cabin with sloping walls

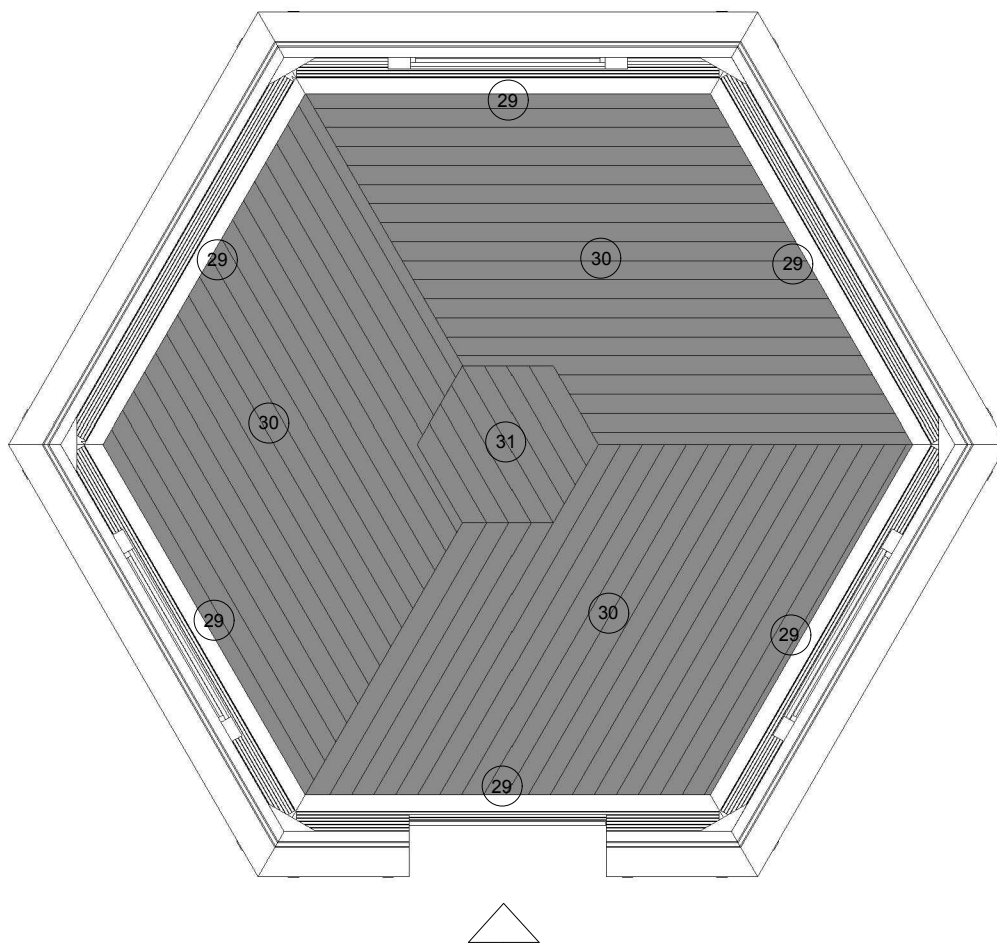

1

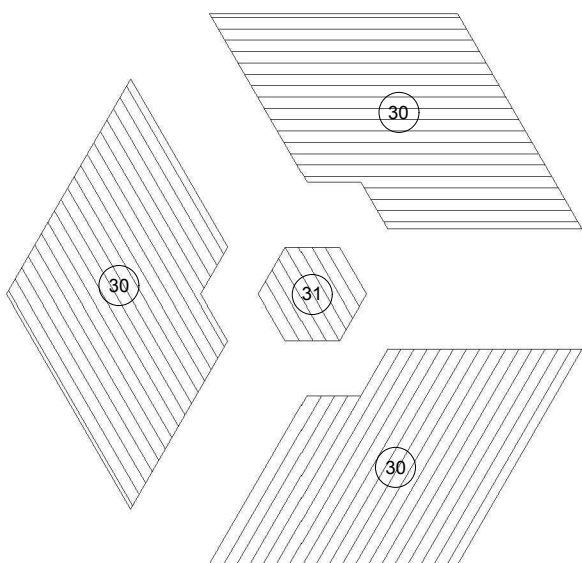

2

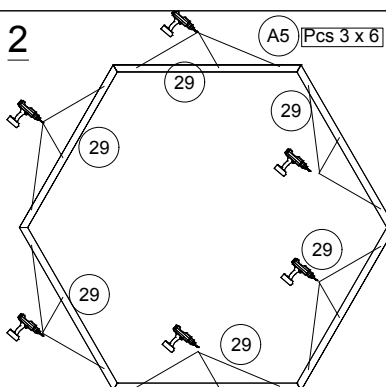

3

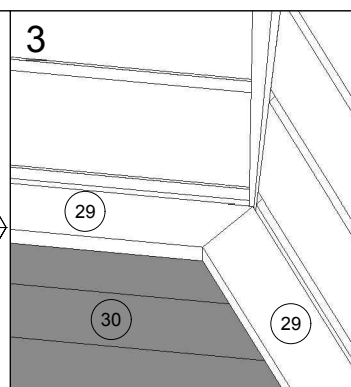

4

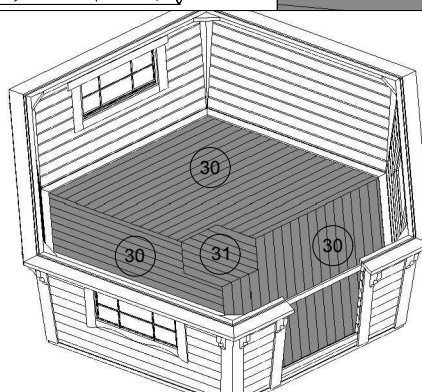

7. Grill cabin with sloping walls

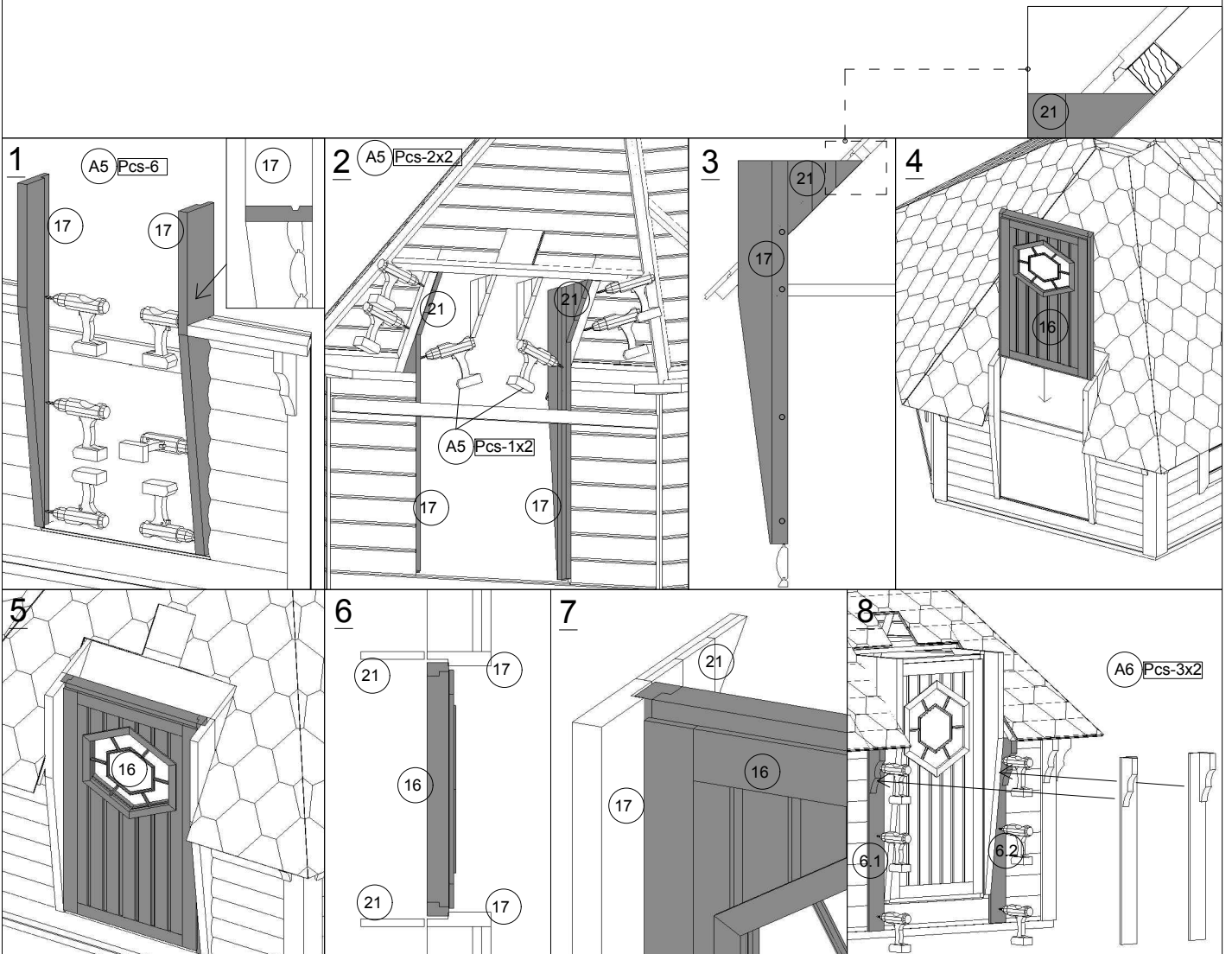
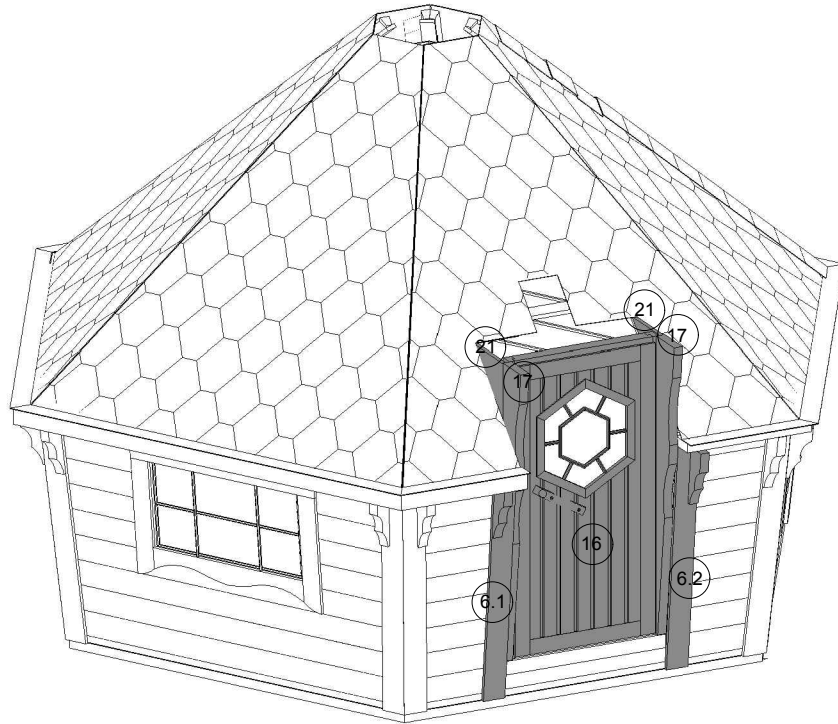

8. Grill cabin with sloping walls

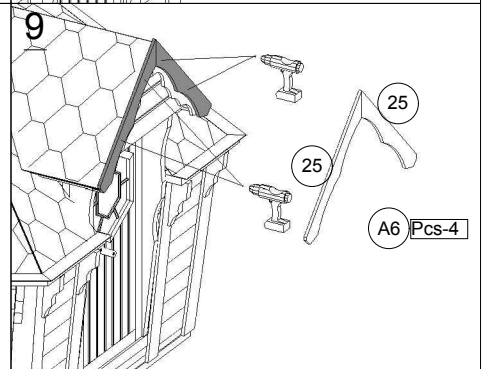
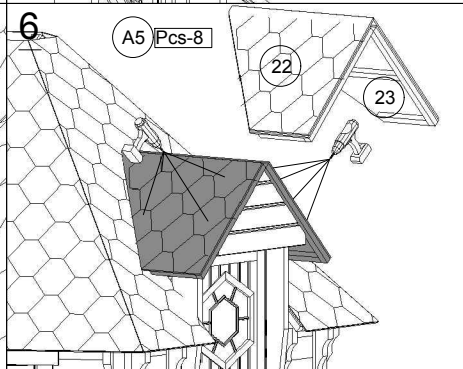
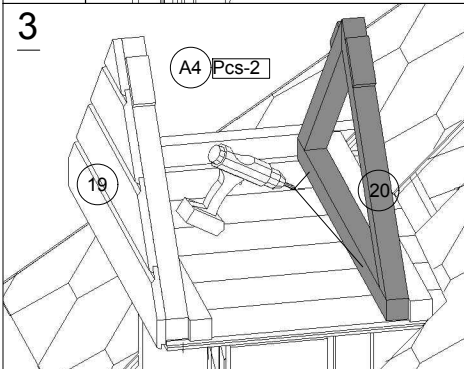
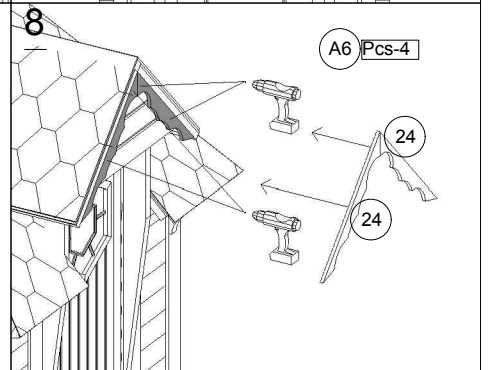
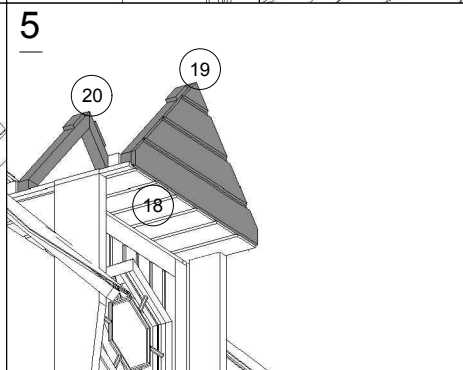
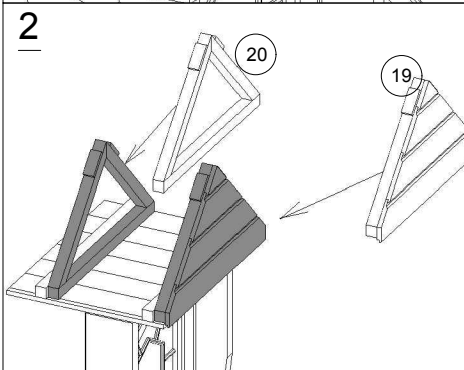
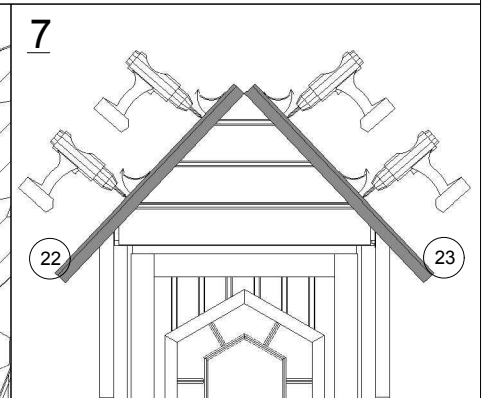
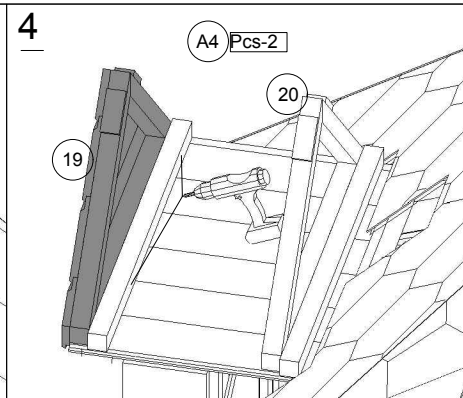
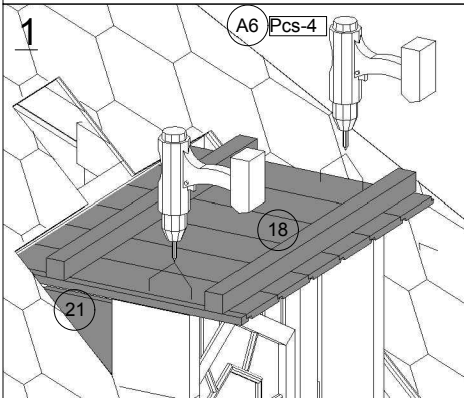
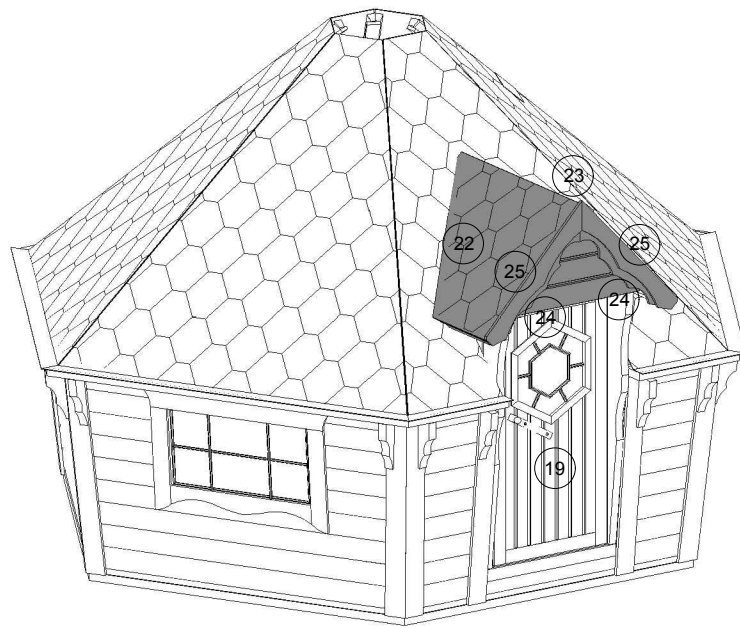

9. Grill cabin with sloping walls

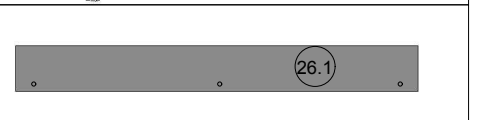
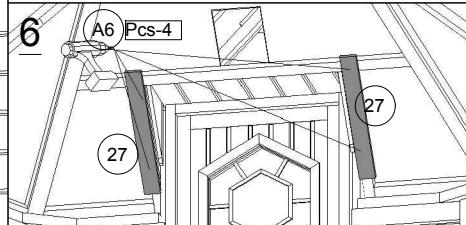
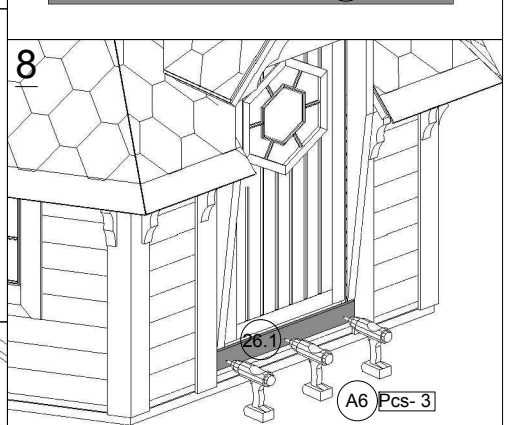
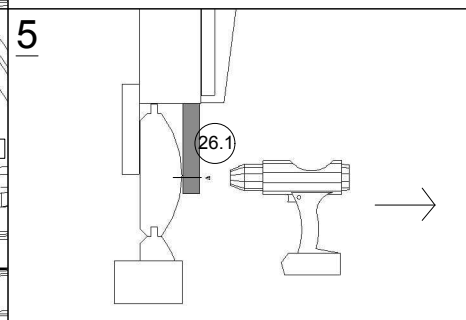
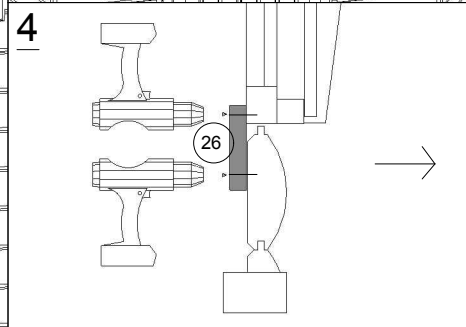
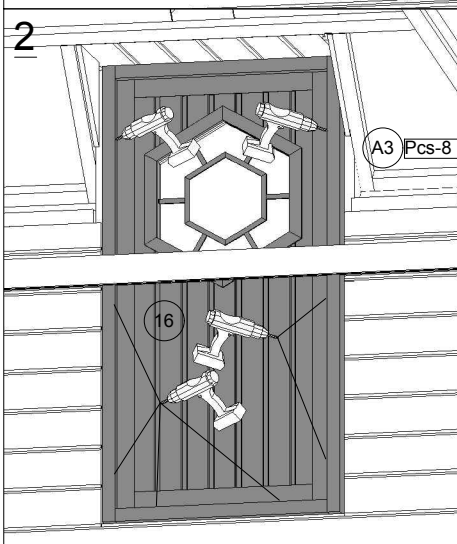
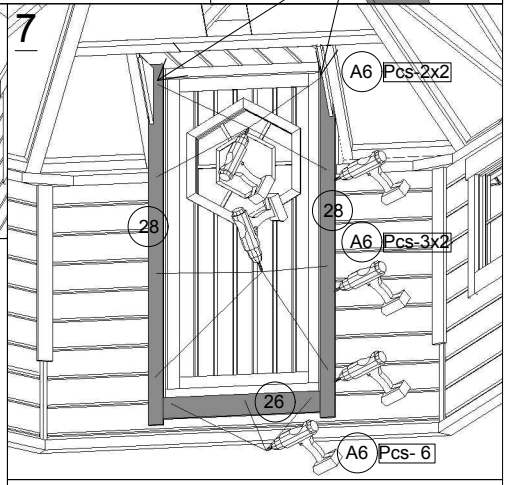
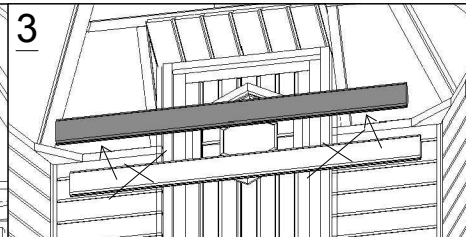
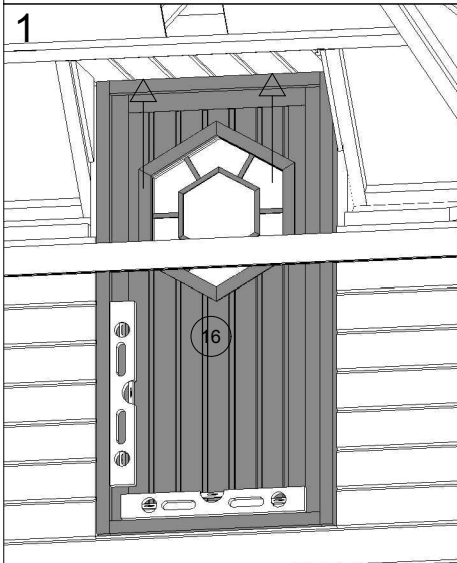
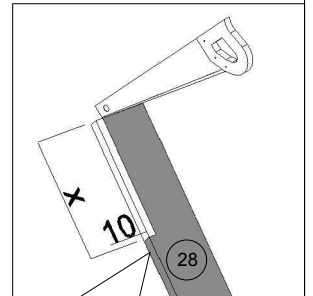
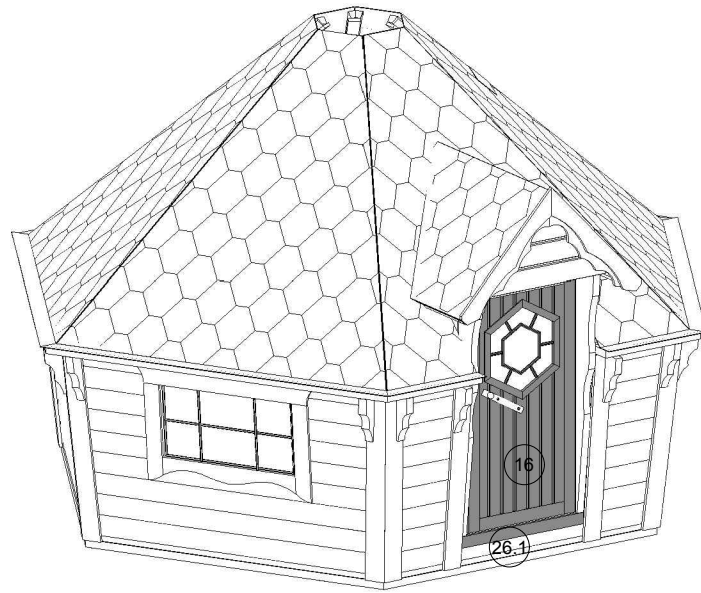

10. Grill cabin with sloping walls

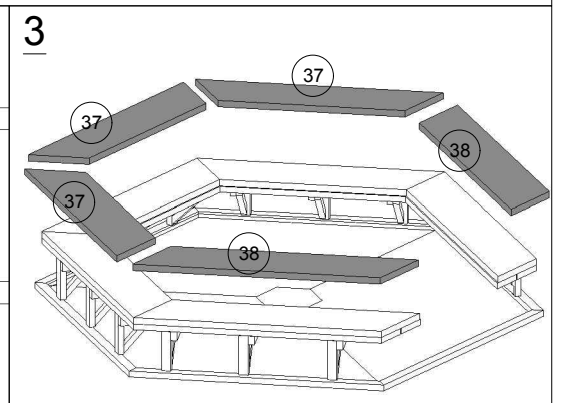
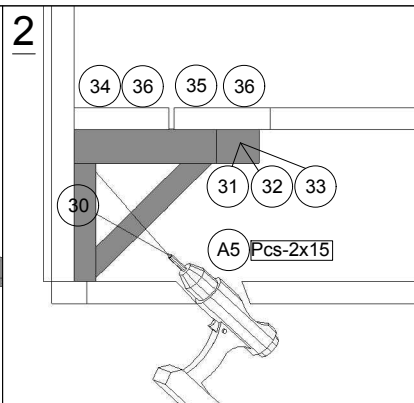
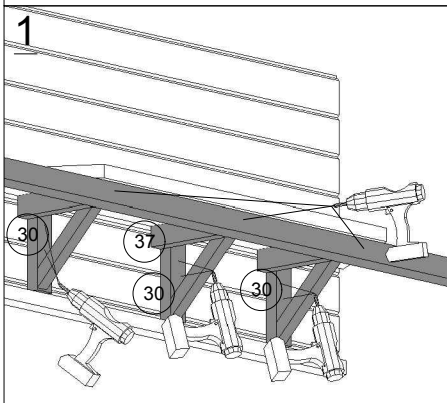
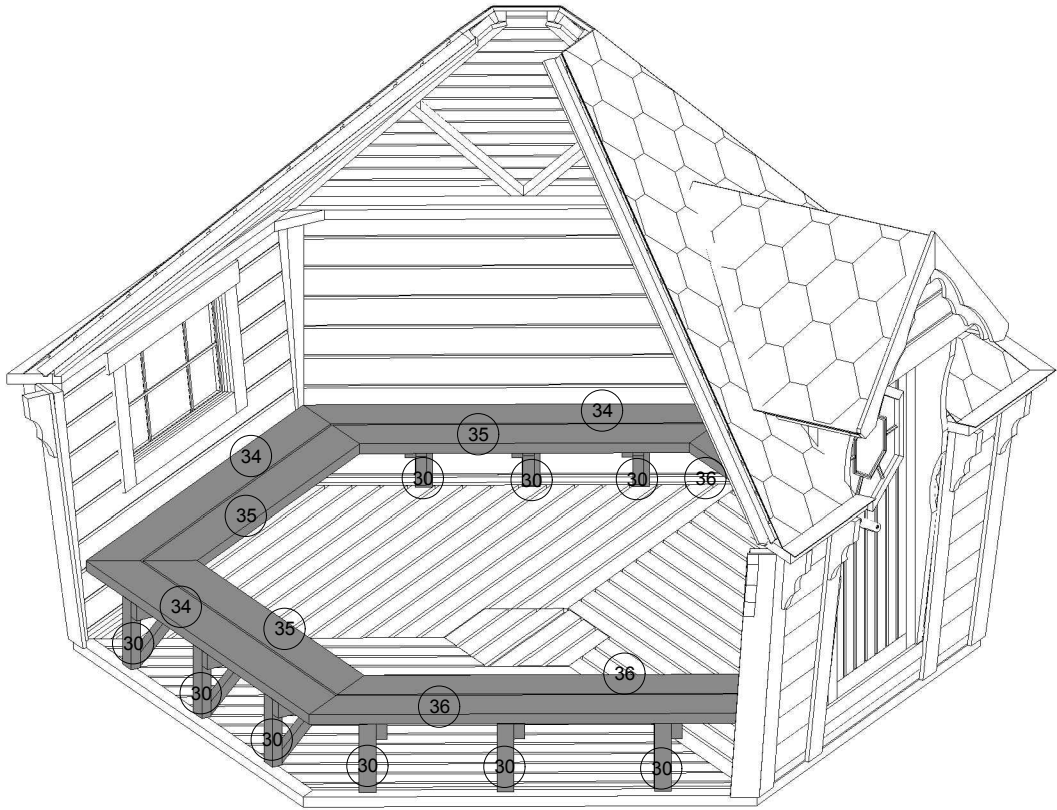

11. Grill cabin with sloping walls

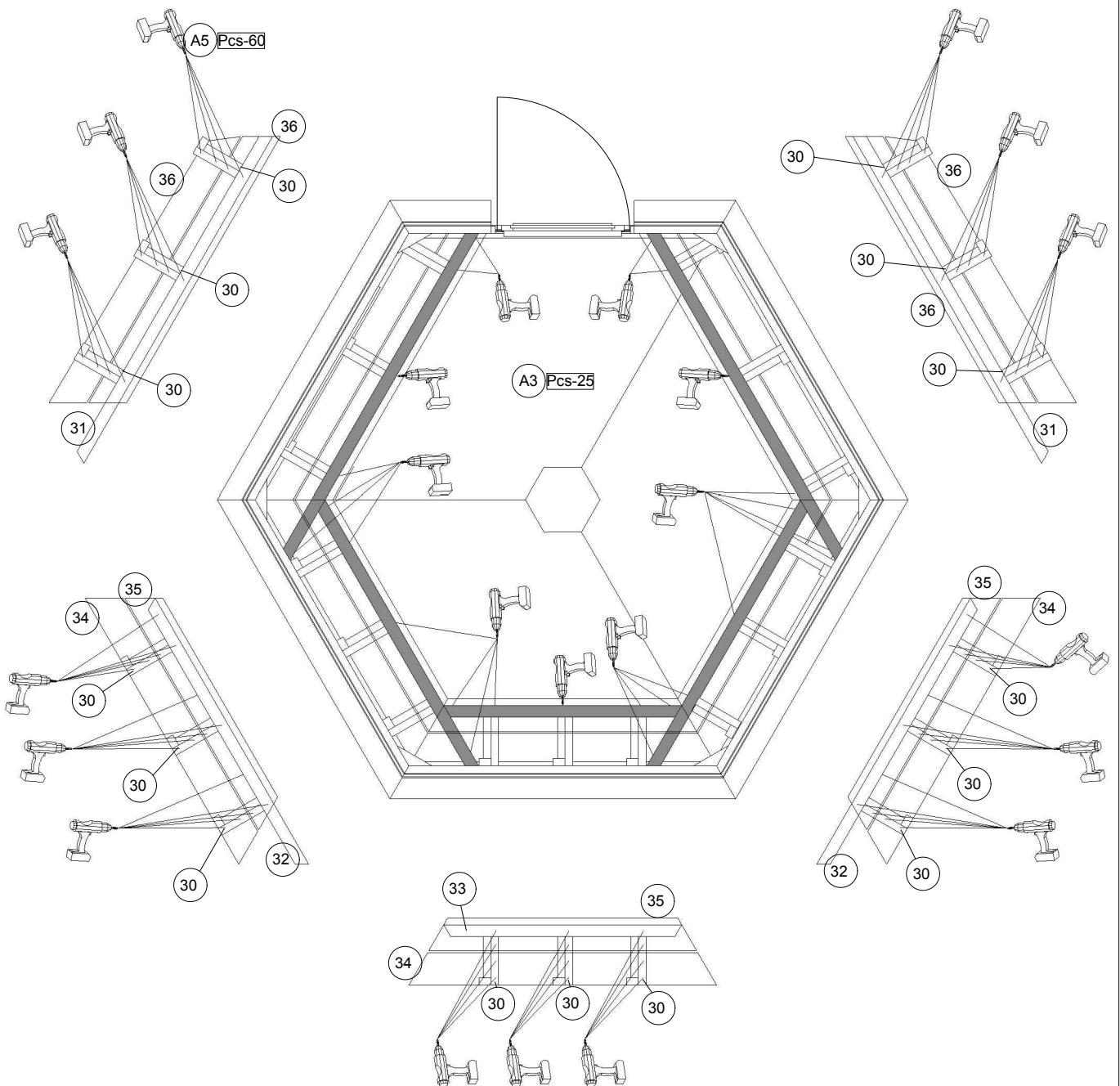

12. Grill cabin with sloping walls

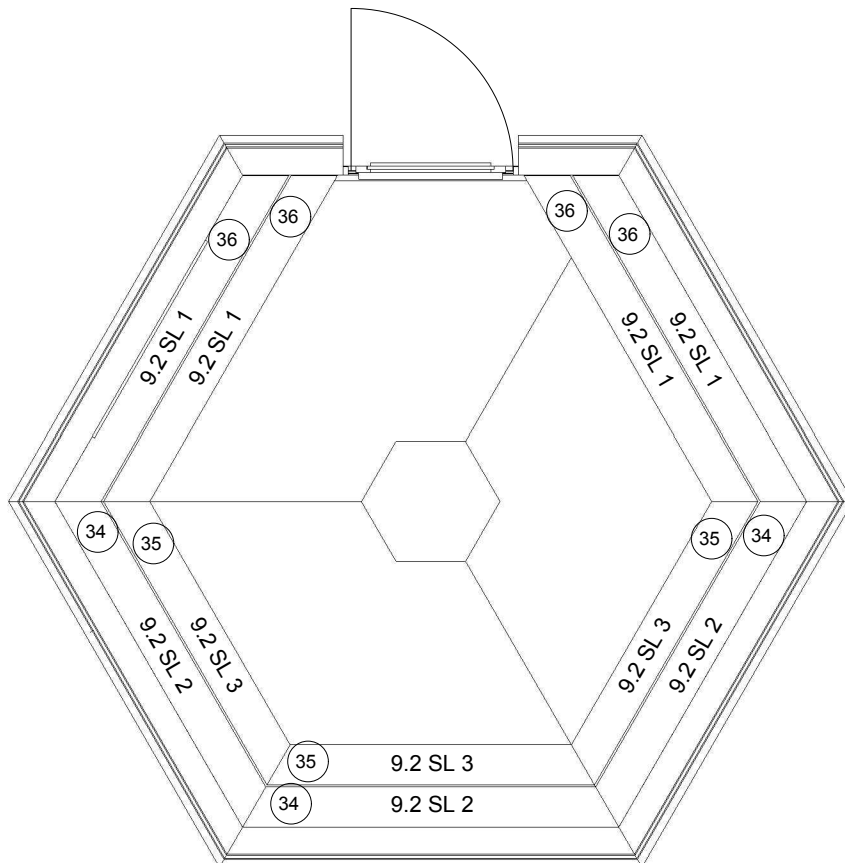
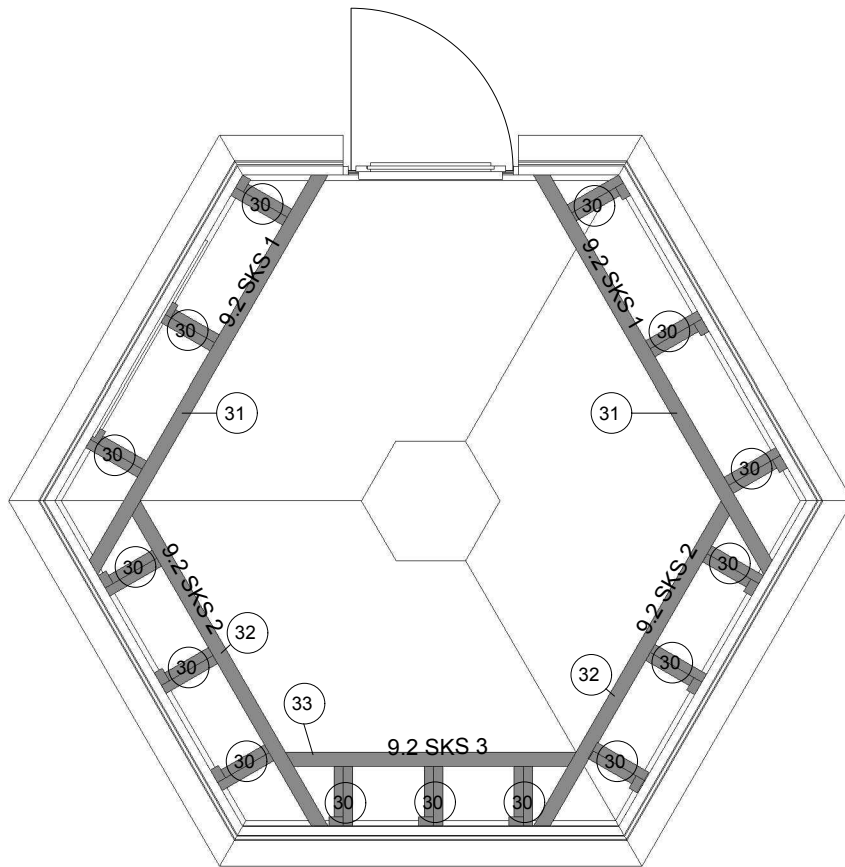

13. Grill cabin with sloping walls

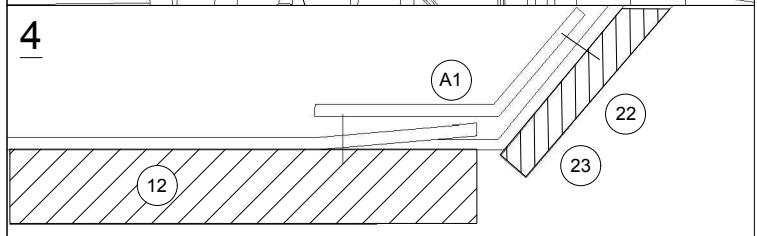
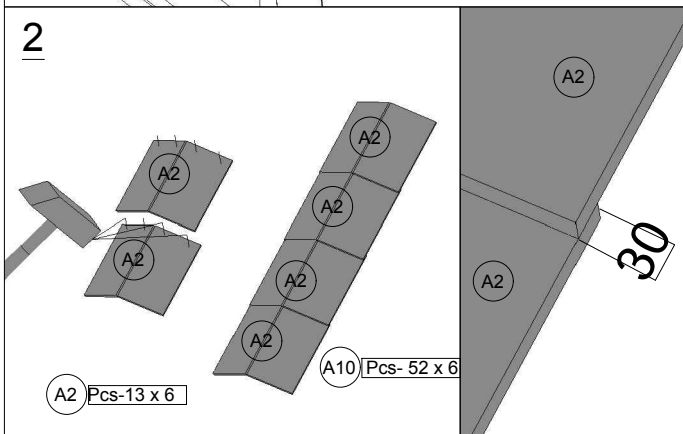
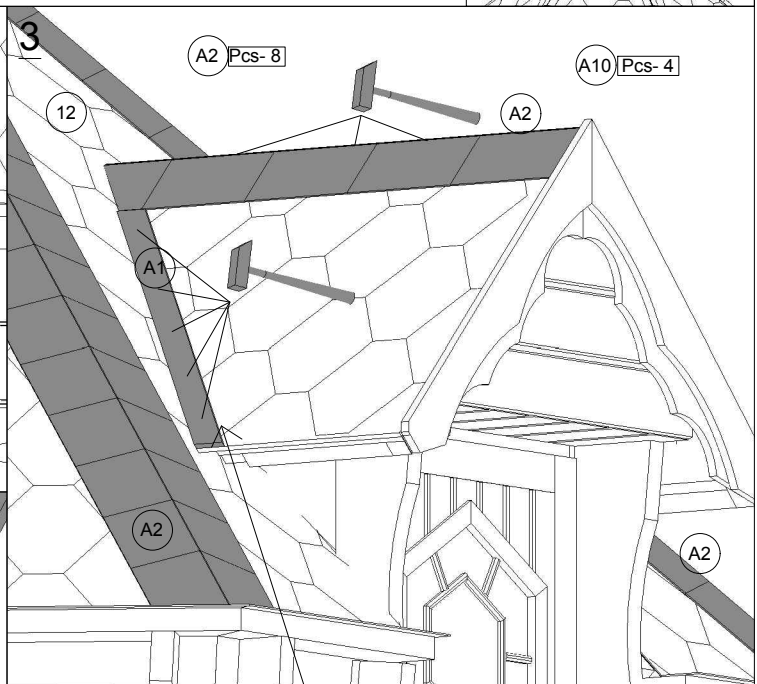
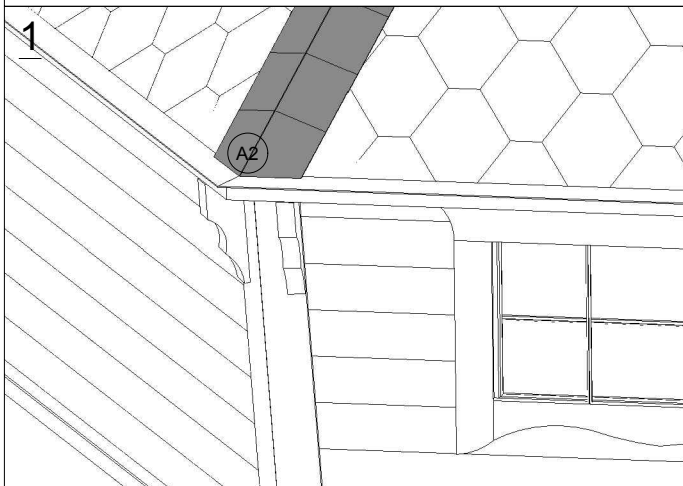
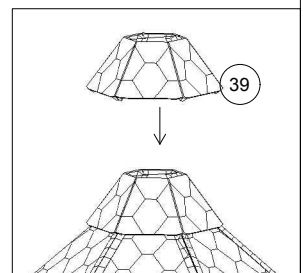
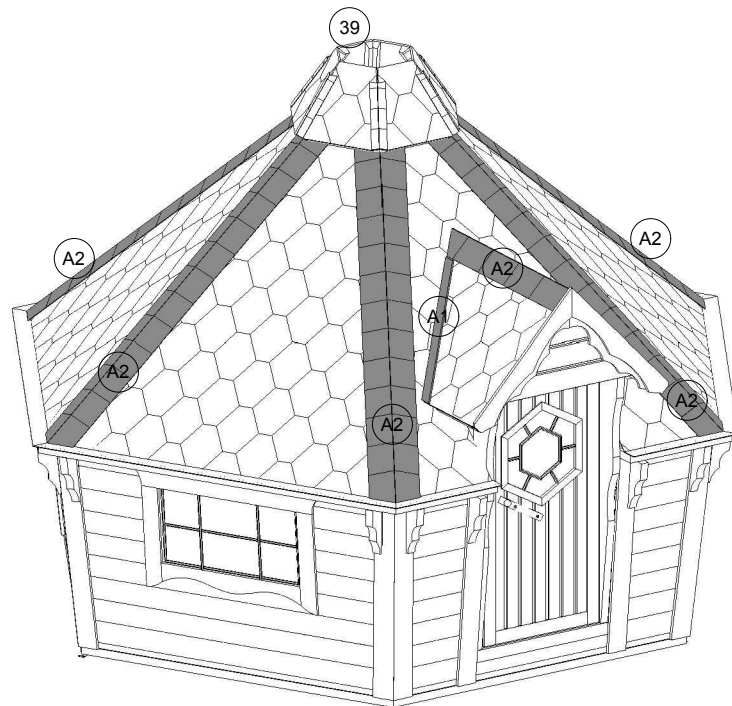

14. Grill cabin with sloping walls

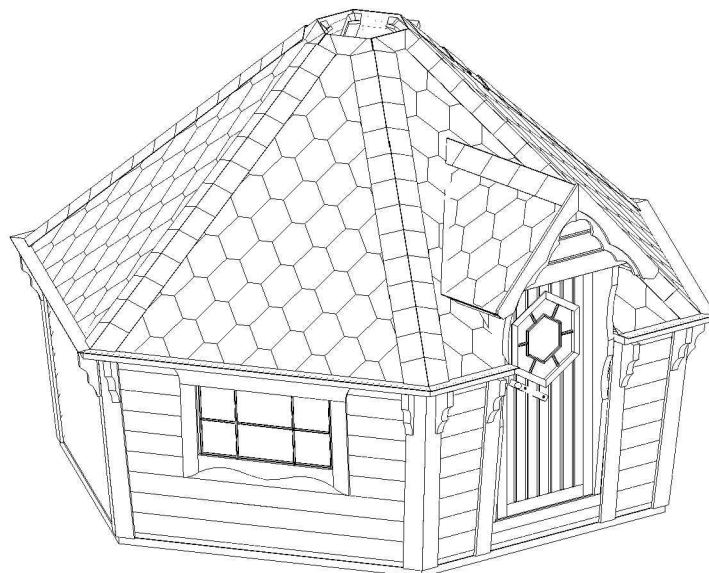
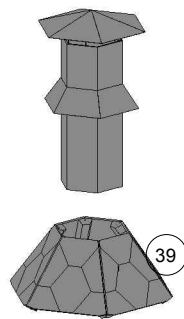
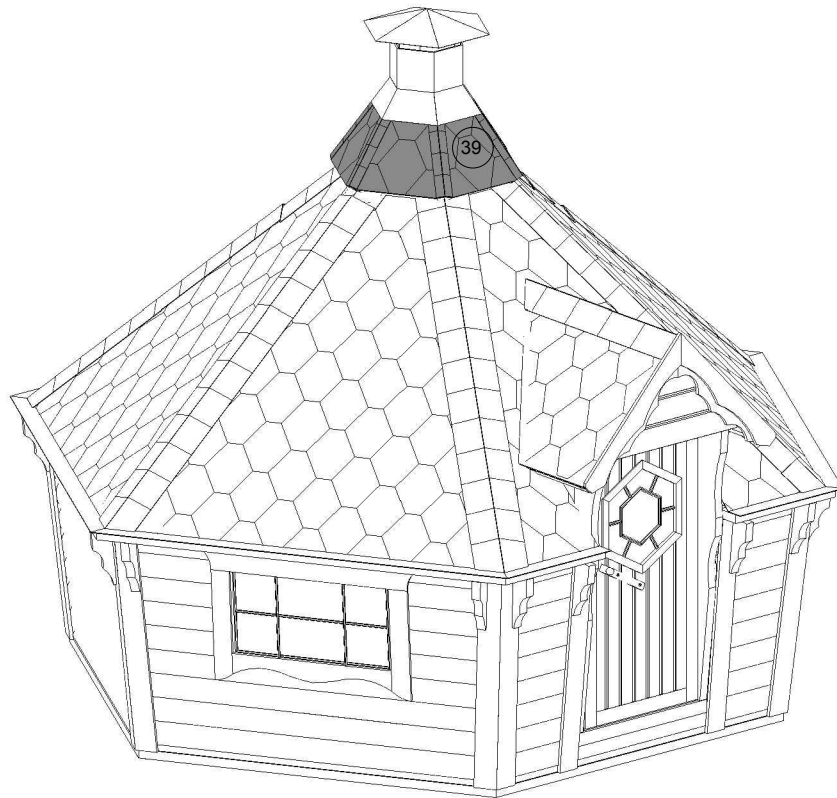

15. Grill cabin with sloping walls

1

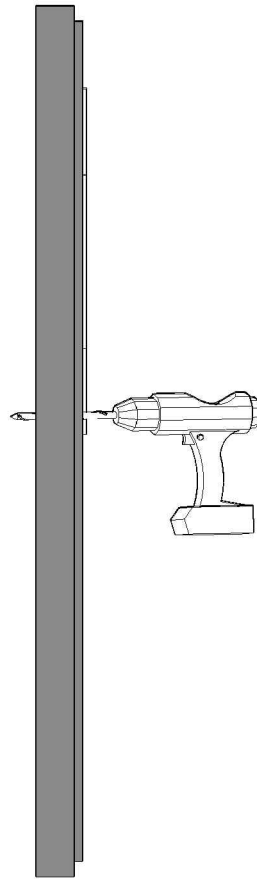
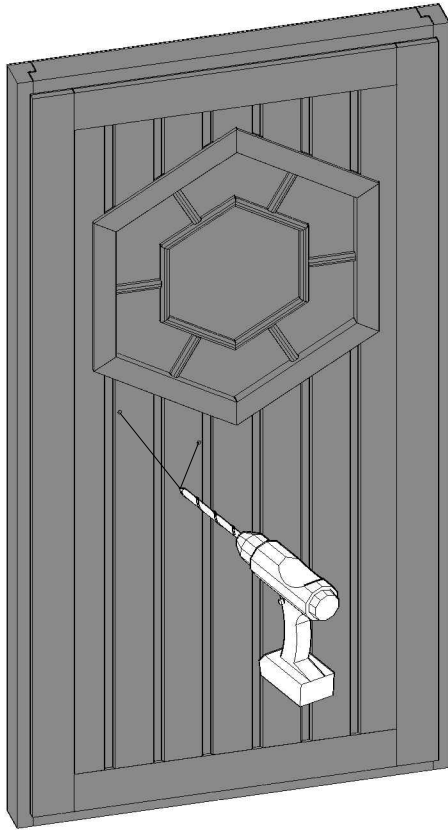

2

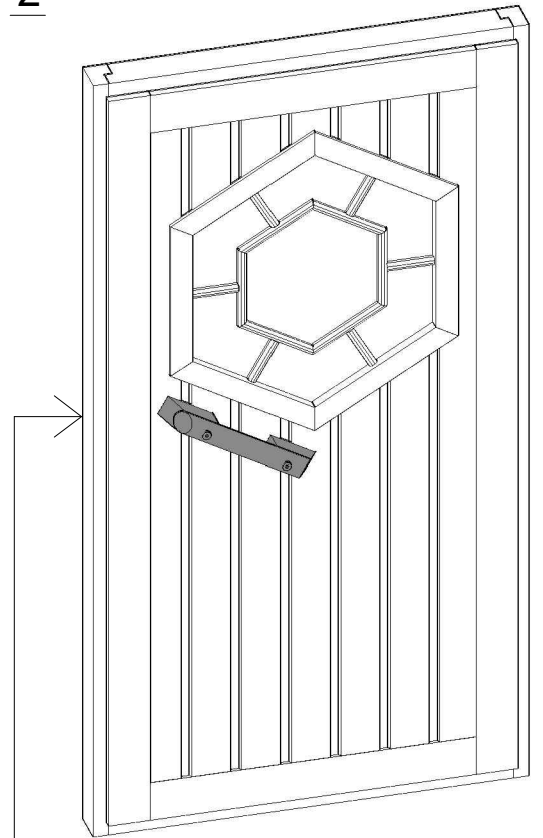

3

