

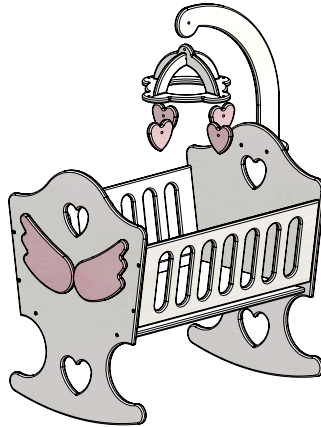



Bed for Dolls "Little Angel"

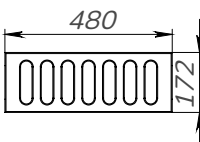
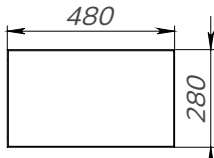
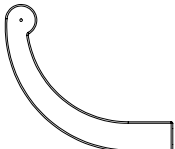
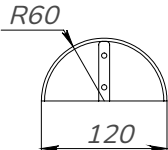
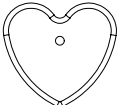
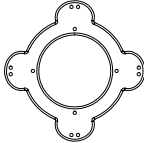
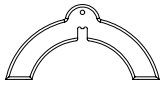
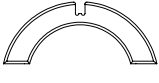

ASSEMBLY DETAILS

<p>1 - Front side</p>  <p>1 pc.</p>	<p>2 - Back side</p>  <p>1 pc.</p>	<p>3 - Sidewall</p>  <p>2 pcs.</p>	<p>4 - Lower base</p>  <p>1 pc.</p>	<p>5 - Holder</p>  <p>1 pc.</p>
<p>6 - Holder base</p>  <p>1 pc.</p>	<p>7 - Decorative heart</p>  <p>4 pcs.</p>	<p>8 - Hanger base</p>  <p>1 pc.</p>	<p>9 - Upper hanger part</p>  <p>1 pc.</p>	<p>10 - Lower hanger part</p>  <p>1 pc.</p>
<p>11 - Confirmat screw 5x40</p>  <p>20 pcs.</p>	<p>12 - 3 mm Hex key</p>  <p>1 pc.</p>			

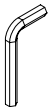
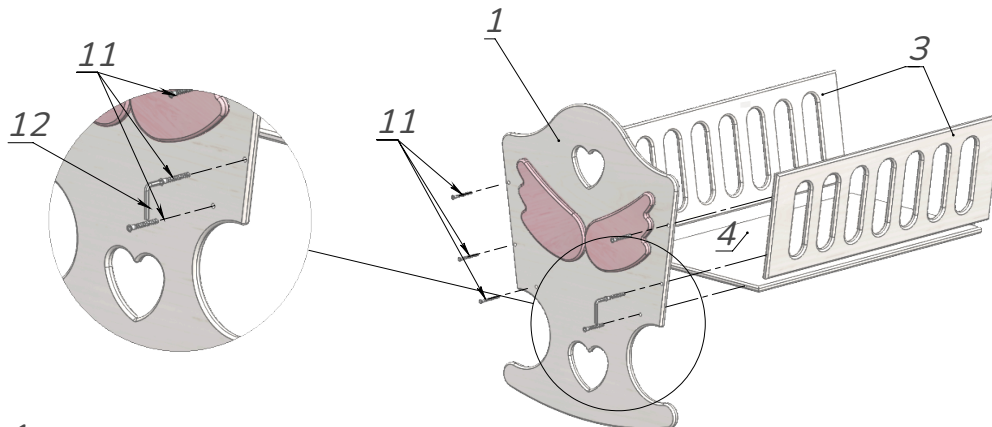

Pic. 1

Take the front side (1) and using the confirmat screws (11) and 3mm hex key (12), connect the sidewalls (3) and lower base (4) to it. See Pic.1

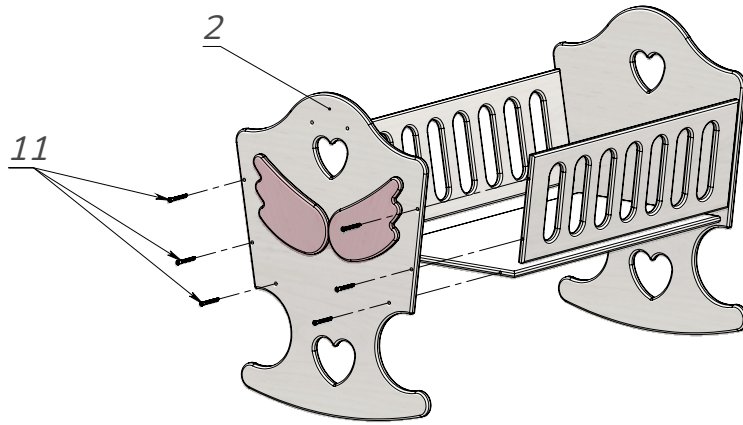

Pic. 2

Using the confirmat screws (11), connect the back side (2) to the previously assembled construction. See Pic. 2.

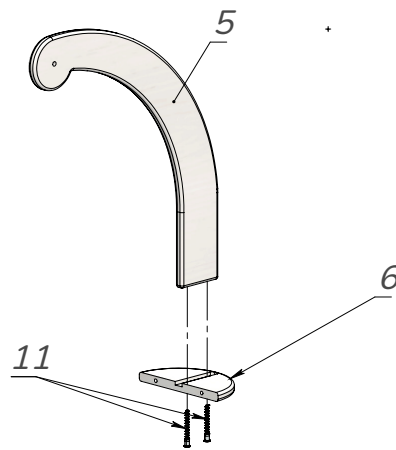

Pic. 3

Take the holder (5) and insert it into the groove in the holder base (6). Fix with the confirmat (11) screws from beneath. See Pic. 3.

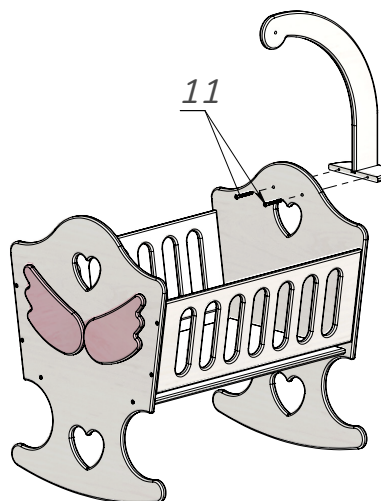

Pic. 4

Connect the holder construction with the back side (2) using the confirmat screws (11). See Pic.4

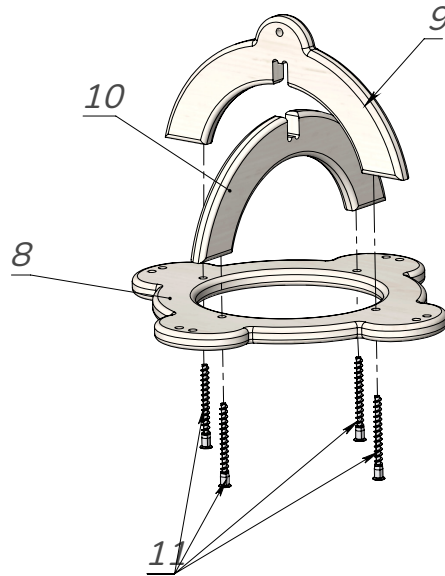

Pic. 5

Take the hanger base (8) and using the confirmat screws (11), connect the lower hanger part (10), and after - upper hanger part (9) from beneath. See Pic. 5.



Use only for its intended purpose, indoors, under the direct supervision of adults.

Responsibility for any damage incurred by children during play on the furniture rests with the supervising adults.

Always be vigilant during children's play.