

bixdo®

P50 Smart Cordless Oral Irrigator Instruction Manual

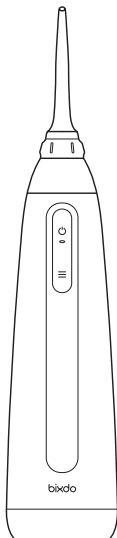

This manual is suitable for all P50 products.
Different products are differentiated only in colors.

Contents

Important Safeguards	04
Product Description	09
Getting Started	12
Tip Usage	19
Battery Power Indicator	21
Cleaning & Maintenance	23
Troubleshooting	26
Environmental Protection	27
Product Parameters	29
Limited Warranty	30

Important Safeguards

DANGER:

To reduce the risk of electrocution and other risks, please note the following:

- 01 Please check whether the USB charging cable of the charging base is damaged prior to first use.
- 02 If the USB charging cable is damaged, please contact after-sales service for a replacement;
- 03 Do not put this product into fire or heat it;
- 04 Do not immerse this product into water for an extended period of time to avoid product function failure;
- 05 Do not plug in or unplug the power plug with wet hands. When unplugging or plugging in the power cable, be sure to hold the plug instead of the USB charging cable;
- 06 Please do not damage, destroy or modify the charging device, do not forcefully stretch, bend or twist the USB charging cable; avoid heavy objects on the USB charging cable, or USB charging cable jammed between objects;

- 07 Do not drop or insert foreign objects into any openings on this product;
- 08 Keep the product, charging base and USB cable away from heated surfaces;
- 09 Please use a power adapter that meets national safety certification requirements;
- 10 Do not place the product in a high-temperature or humid location, and avoid direct sunlight;
- 11 Before cleaning and maintenance, please ensure that the product is turned off and not charging.

Important Safety Precautions

WARNING:

To reduce the risk of burns, electrocution, fire, or injury to persons

- 01 Do not operate this product in a manner other than that specified in this Manual;
- 02 Do not use this product without a tip inserted;
- 03 This product is not intended for use by persons (including children) with reduced physical, sensory or mental capabilities, or lack of experience and knowledge, unless they have been given supervision or instruction concerning use of the product by a person responsible for their safety;
- 04 Please place this product out of the reach of children and infants, and it should not be used as a toy;
- 05 For patients with periodontal disease or those who have undergone oral surgery in the past 2 months, please consult your doctor before use;

- 06 Only use the tips and accessories that are included, sold or recommended by bixdo;
- 07 Do not disassemble this product or replace the parts of this product to avoid damage or potential risks;
- 08 Do not fill the reservoir with water above 40°C for oral cleaning to avoid burn;
- 09 Do not use this product for purposes other than oral cleaning;
- 10 Do not press the tip hard on the gums or teeth, so as to avoid injury;
- 11 Do not use or operate where aerosol (spray) products are being used or where oxygen is being administered;
- 12 Remove any oral jewelry prior to use of this product;

- 13 Do not use iodine, saline (salt solution) or water-insoluble concentrated essential oils in the product. Use of these can reduce the performance and shorten the life of the product.

Do not fill the reservoir with mouthwash (including common mouthwash, concentrated mouthwash, mouthwash essence, etc.) directly into this product. If you need to use mouthwash, please contact customer services before using.

- 14 Do not point the tip towards the tongue, ears, nose or other weak parts. Doing so could result in serious injury due to the stream of water of this product.

- 15 For patients with severe periodontal disease, receiving oral treatments or those who have concerns about the discomfort in the mouth, please consult a dentist before using.

Product Description

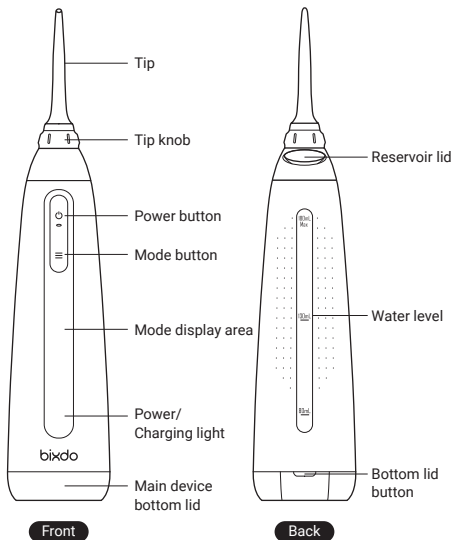

Tip description:

The bixdo Smart Cordless Oral Irrigator includes:

- 2 Standard tips
- 1 Orthodontic tip
- 1 plaque tip

Replacement tips can be purchased at www.bixdo.com or from officially authorized stores.

Replace Every 6 Months

Standard tip

Suitable for

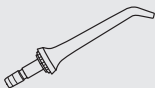

Daily cleaning

Replace Every 3 Months

Orthodontic tip

Suitable for

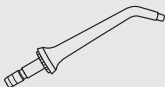

Braces
Daily cleaning

Plaque tip

Suitable for

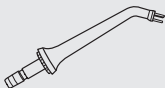

Implants
Bridges
Crowns
Daily cleaning

Getting Started

Please confirm whether the power is sufficient prior to use (when the product is turned off, press the Mode/Power button, the Mode light will turn on, and the battery indicator light will stay lit).

Charge the product prior to first use. (the battery indicator light will stay lit). When the batteries are in need of charging, the battery indicator light will blink to indicate that you should recharge the product.

Step 1: Inserting and Removing Tips

Take the tip out of the tip storage case, insert tip into the center of the knob at the top of the oral irrigator magnetic tip base until the tip clicks into place. Tip will be firmly placed on the product.

To remove the tip, please turn off the product first, then pull the tip from the product.

Reminder:

This product is used with a magnetic tip. When inserting the tip, please avoid the adsorption, blockage or jamming of foreign metal objects in the magnetic part, which may cause the tip fails to click into place, or fails to eject water normally.

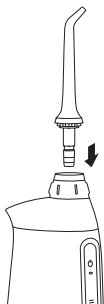

Step 2: Filling the Reservoir

Lift flip top on reservoir and hold the product upright to fill it with water. Close the flip top after filling.

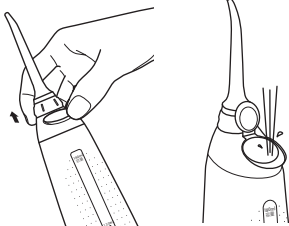

Step 3: Choose a suitable mode

Select the desired mode by pressing the Mode button gently.

This product has 5 modes. The specific functions from top to bottom are as follows:

- STRONG** — Suitable for users with severe food impaction
- NORMAL** — Cleans plaque and food debris that is left behind
- GENTLE** — Clean and remove stubborn food debris that is left behind more gently
- SOFT** — Suitable for sensitive teeth and gums
- GUMCARE** — Provides precise and fine care through irrigation to specific parts, such as orthodontic teeth, implanted teeth, dental crowns, etc.

Reminder:

If you are a beginner, it is recommended that you start with Sensitive or Gentle Mode to avoid gum discomfort caused by high water pressure.

Step 4: Preparation before use

Before use, lean low over sink and place tip in mouth. Aim the tip toward teeth, gumline and gum and direct the jet stream at a 90-degree angle to the treated areas. Slightly close lips to avoid splashing but allow water to flow freely from mouth into the sink.



Reminder:

When using the oral irrigator for the first time, you may experience itching or slight bleeding of the gums.

It usually disappear within 1-2 weeks. If it persists for over 2 weeks, it may indicate symptom of gum illness. In this case, please stop using the product and consult your dentist.

Step 5: When using

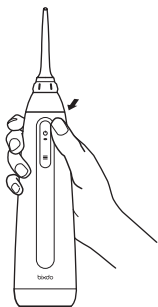

Press the Power button to turn on the product. If you need to pause while using, press the Power button again.

This product is designed to automatically turn off after using for 90 seconds. If you need to continue to use, press the Power button again.

In "Gum Care" mode, press and hold the Power button to start the product and release the button to stop it.

Recommended techniques:

For best results, start with the back teeth and work toward the front teeth.

Glide tip along gumline and pause briefly between teeth.

Continue until you have cleaned the inside and outside of both the upper and lower teeth. Direct the jet stream at a 90-degree angle to your gumline. Slightly close lips to avoid splashing but allow water to flow

freely from mouth into the sink. Keep unit upright during use.

Step 6: When finished

When finished, turn off the product and empty any liquid left in the reservoir. Lift flip top on reservoir , and turn the product upside down to pour out all the residue water.

Step 7: Charging

When the batteries are in need of charging, the battery indicator light will blink to indicate that you should recharge the product.

When charging the product, please place the product on the charging base with the front facing forward. If placed correctly, you will hear a 'beep'.

When the product is fully charged, the indicator light will stop blinking and stay lit. After charging, please store the charging base in a safe place for the next use.

Reminder:

When charging, it is recommended to wipe off the residue water on the surface; please charge the product in a dry environment to ensure that the device, charging port, and USB Type-C charging cable port stay dry and free from foreign objects.

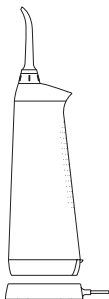

Tip Usage

Orthodontic tip

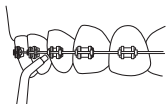

To use the orthodontic tip, gently glide tip along gumline, pausing briefly to lightly brush area between teeth and all around orthodontic bracket before proceeding to the next tooth.

Plaque tip



To use the Plaque tip, place the tip close to the teeth so that the bristles are gently touching the teeth.

Gently glide tip along gumline, pausing briefly between teeth to gently brush and allow the water to flow between the teeth.

Using mouthwash and other solutions:

The bixdo oral irrigator can be used with mouthwash or other antibacterial solutions, but the solutions needs to be diluted according to related instructions.

After using any special solution, rinse the product to prevent clogging by partially filling reservoir with warm water (does not exceed 40°C) and running the product with tip pointed into sink until the reservoir is empty.

Battery Power Indicator

Power-On Battery Power Indicator	
30% battery left or more	When the product is turned off, press the Mode/Power button, the Mode light will turn on, and the battery indicator light will stay lit
5%~30% battery left	When the product is turned off, press the Mode/Power button, the Mode light will turn on, and the power indicator light will blink slowly (typically, it can be used for an additional 15 times after the first time it blinks)
5% battery left or less	When the product is turned off, press the Mode/Power button, the Mode light will not turn on, the power indicator light will blink rapidly, please charge the product.
Battery Charge Indicator	
While charging	The charge indicator light will blink slowly
When fully charged	The charge indicator light will stay lit

Note:

- If the product is being used for the first time or if it has not been used for over 6 months, the charging indicator may not turn on immediately, but will return to normal after a few minutes of continuous charging;
- If the charging temperature is not in the recommended range (10°C to 35°C), the charging time may be prolonged;
- This product contains a lithium-ion battery, charging after use or continuous charging will not affect the battery life;
- If it has not been used for more than 6 months, the battery will be affected, however, please make sure to fully charge the product every six months.

Cleaning & Maintenance

Please refer to the following steps for cleaning and maintenance prior to first use or the oral irrigator has been stored for an extended period of time.

If the product to be stored for an extended period of time, be sure to drain the water in the reservoir and tubes to avoid unpleasant smell caused by residue water.

Cleaning the product

- ① Please use clean water or mild cleanser to clean the product; do not use corrosive or abrasive cleanser, and do not use hot water over 40°C to clean any part of the product to avoid damaging the product and reducing its performance.
- ② Do not immerse the bixdo oral irrigator into the water for an extended period of time. When cleaning the charging base, please unplug the USB charging cable from the power outlet first. When necessary, you may clean the product by using a soft cloth and mild non-abrasive cleanser to wipe exterior.

- ③ After cleaning, you can place the tip in the included tip storage case, and use the included travel plug to avoid foreign matters.

Cleaning the reservoir

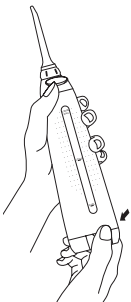

- ① Hold the reservoir with one hand, while pressing the button at the back of the reservoir, and pull it back to open the bottom lid of the reservoir.

Please rinse the inside of the reservoir with warm water, and do not use any cleanser to clean the reservoir.

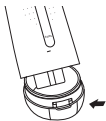

- ② After cleaning, please put the reservoir lid back on the product. The front of the reservoir lid should match the snap, then you can push the back of the lid until it clicks into place. Please be sure to install the bottom lid of the reservoir before filling it with water for use.

Removing hard water deposits

- ① Hard water deposits may build up in the product, depending on the mineral content of the water. If left unattended, it can hinder performance.
- ② Fill the reservoir with clean warm water, point the tip into the sink, turn power on and run until the reservoir is empty. Rinse by repeating with a full reservoir of clean warm water. This process should be done every 1 to 3 months to ensure optimal performance.

Troubleshooting

Fault	Cause	Solution
Malfunction. No response when pressing the button.	Insufficient battery	Contacting after-sales service
The indicator light does not turn on	Circuit failure	Charging the battery
	The charging base is not placed on the correct position	Place the charging base on the correct position and make sure the power is connected
Low water pressure	The tip is damaged or Insufficient battery	Replacing the tip or recharging
Even it is fully charged, the battery runs out shortly	Insufficient charging time	Charging the battery
	Circuit failure	Contacting after-sales service

Environmental Protection

This product uses a rechargeable lithium battery.

Please remove the built-in rechargeable battery before you dispose the product.

Batteries should be recycled or disposed according to local administrative regulations.

Please do not disassemble the product unless you want to dispose it. (Otherwise the waterproof function will be damaged and the product will not function normally.)

- 1 Before removing the battery, please make sure that the product is powered off.
- 2 If you need to drain the battery power, you can press the power button until the product stops runningt.
- 3 Disassemble the product in the sequence shown in Image ① - ⑦, and remove the battery.
- 4 During the disassembly process, do not short-circuit the battery, do not connect the "+, -" poles of the battery after removing it, and tape the wires for insulation protection.

- 5 After removing the battery, do not power on the product again.

Battery Removal:

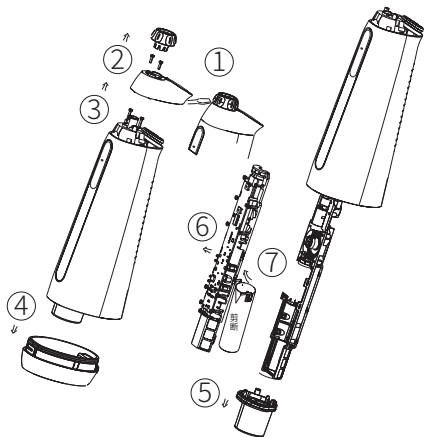

Product name

Product name	bixdo Smart Cordless Oral Irrigator
Product name	P50
Rated Voltage	5V \equiv
Rated Current	1A
Charging time	10~12 hours (under bixdo laboratory test conditions)
Country of origin	Tianjin, China
Implementation standard	IEC60335-1/IEC60335-2-52
Waterproof level	IPX7
Product size (mm)	Length:77; Width: 58; Height: 207
Net weight	280g
Battery run time	About 30 days (The estimated time is to use the product twice a day, 1 minute for each use with medium pressure setting. Data source: bixdo laboratory)

Limited Warranty

bixdo offer 1 year limited warranty from the date of purchase.

bixdo warrants this new product is free from defects in materials and workmanship for 1 year from the date of purchase. Consumer will be required to present the original purchase receipt as proof of purchase date and if requested, the entire product, to support a warranty claim. bixdo will repair or replace at its sole discretion provided the product has not been abused, misused, altered or damaged, and was used properly following this instruction. This limited warranty excludes accessories or consumable parts such as tips etc. **Use with unapproved accessories will damage product and VOID this warranty.**

bixdo® oral Irrigators have no consumer-serviceable electrical items. For all parts, accessories, services and questions go to www.bixdo.com. Refer to the date code and model numbers in all correspondence. These numbers are located on the bottom of the unit.

The content of hazardous substances in the products complies with the EU RoHS Directive (2022/65/EU)

bixdo®

Email: service@bixdo.com.cn

Manufacture: Bixdo (SH) Healthcare Technology Co., Ltd

Adress: Room 712, Building E, The Mixc, No. 3999,
Hongxin Road, Minhang District, Shanghai, China