

TELECOM PRODUCT CATALOG



FROM THE PRESIDENT AND CEO

In today's world of Telecommunications, there is no substitute for quality, reliability, and on time delivery. Westek's mission is to manufacture products that will save time in a high speed telecommunications world. Technicians cannot afford to waste precious time when performing tests that demand exact results.

Westek's products feature ease of use and accurate results. Our products are heavy duty, light weight construction, and built with state of the art materials. We design and manufacture our products in a way to eliminate the inherent problems that cause inaccurate readings or failure which often plague other cord manufacturers. Here at Westek, we electronically and mechanically check all our quality products at the point of manufacturing completion.

We also manufacture under quality programs such as TQM and ISO 9001:2008.

Westek's main focus is supplying and manufacturing quality products at competitive prices.



We strive to build quality relationships with our customers by providing excellent customer service, supported by product knowledge.

Westek has worked for you the past 30 years and our strength and reliability will continue.

Sincerely,

Kevin Larkin
President and Chief Executive Officer





WESTEK
Electronics, Inc.

185

185



EXPANDING TO A LARGER STATE OF THE ART FACILITY TO BETTER SERVE YOU!

Customer Service First.

At Westek, our customer's success is our success which is why we are committed to continuously building upon a foundation devoted to outstanding customer service. We are dedicated to providing you with the support necessary to succeed in this ever-changing, competitive global marketplace. Simply stated, if there is a way we can make your job easier, we will find it.

We do this by responding individually to your inquiries on a timely basis. We also utilize state of the art, integrated ordering and tracking systems which deliver the most up-to-date information available on inventory, order status and product availability. In addition, our customer service specialists provide the technical information necessary to help you choose the products for your specific needs.

For additional information, please contact a customer service representative toll free at (800)-526-2673 weekdays between 7 AM to 4:00 PM PST. Or for service 24/7 visit us online at: www.westek.com



WESTEK
Electronics, Inc.

WWW.WESTEK.COM

Fiber Multi-Tool Solution

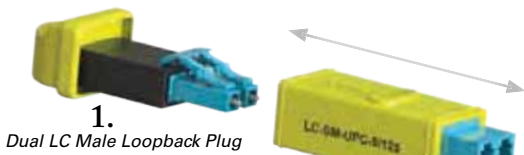
NEW

**Male Loopback, Female Loopback,
Plug-in Connector Coupler, & Parking Lot**

Four Fiber Tools in One Pat. Pend. LC or SC

1. Dual LC or SC Male Plug for Loopback Electronics Testing
2. Dual LC or SC Female Plug for Loopback Cable Testing
3. Dual LC or SC Female Loopback
4. Park your exposed cable fiber plug ends, keeping them clean and damage free

Slide all three components together to create a dustproof, crushproof and moisture resistant case



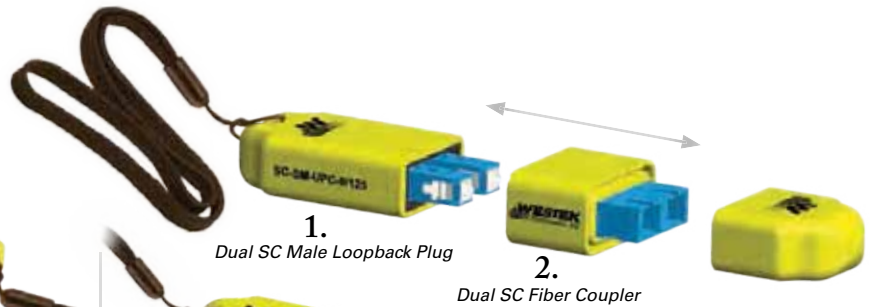
1. Dual LC Male Loopback Plug

2. Dual LC Fiber Coupler



3. Dual LC Female Loopback Plug

4. Also Park your exposed Fiber ends keeping them clean and damage free



1. Dual SC Male Loopback Plug

2. Dual SC Fiber Coupler

3. Dual SC Female Loopback Plug

4. Also Park your exposed Fiber ends keeping them clean and damage free

LC



Duplex LC Singlemode UPC 9/125
FC LB7102

Duplex LC Multimode UPC 62.5/125
FC LB7202

Duplex LC LO Multimode 50/125
FC LB7502

Duplex LC Singlemode APC 9/125
FC LB7102A

**Call your Regional
Service Manager
800.526.2673**

SC



Duplex SC Singlemode UPC 9/125
FC LB3102

Duplex SC Multimode UPC 62.5/125
FC LB3202

Duplex SC LO Multimode UPC 50/125
FC LB3502

Duplex SC Singlemode APC 9/125
FC LB3102A



Partner For Fiber Success

WESTEK'S ALL NEW FIBER TOOL

Fiber Optic Insertion and Removal

Westek's Fiber Tool installs and removes all connectors. This elegant device simply fits into a shirt pocket or tool pouch and is ergonomically designed to fit the hands of today's technician while at the same time mitigates any potential for repetitive motion or significant squeeze issues/injuries. Supports most Fiber optic connectors and exceeds the stringent requirements dictated by Telcordia Technologies, ANSI, OSHA, FDA, NTA and the IEC.



Fiber Tool - FP 360023 *

- Integrated flashlight feature enables tech to see in low-lit areas
- Extremely well balanced with ergonomic pads that provide the minimum pressure necessary to capture/place the connector
- Eliminates from touching or moving other connectors preventing service disruption
- Patented locking ratchet design to hold plugs securely.
- Designed to fit comfortably in either hand
- One Year Warranty



MC1000 - Rev. 3 - 01/2010

WWW.WESTEK.COM

ORDER ONLINE NOW

Westek proudly accepts



WESTEK
Electronics, Inc.

ph: 800-526-CORD fax: 800-526-FAXX Expect the Best.

TO SEE OUR COMPLETE LINE OF TIME SAVING
TECH TOOLS ALONG WITH ONLINE ORDERING
PLEASE VISIT US AT: WWW.WESTEK.COM

All The Tools You Need to Stay Connected

Westek Patented Solutions -Fiber Optic - DS1- DS3 - Data Cables - Portable lighting
- Workstations - Splicing - Restoral - Combi Cords
- Prem - Cabinet - Central Office - Outside Plant



Test Cord Kit's



Portable 4500 lumen Lamp w/magnetic base



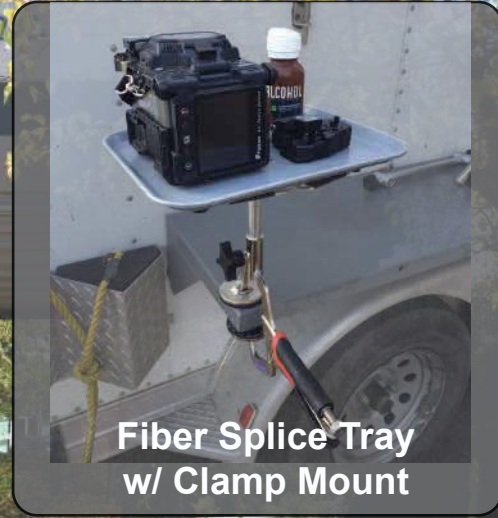
Portable 1500 lumen Lamp w/magnetic base



FOSC 3 in 1 end plate fixture



FOSC work station w/ Tri-pod



Fiber Splice Tray w/ Clamp Mount

OSP Technician Test Access Kits



1(800) 526-2673 www.westek.com



P/N: KT CAB2BK

- Network Interface Device "NID"
- Serving Area Interface "SAI" box
- Test and trouble shoot Copper lines
- Rugged test cables and connectors
- Increase productivity quality
- Inquire about other specialty connectors



P/N: KT CAB3BK

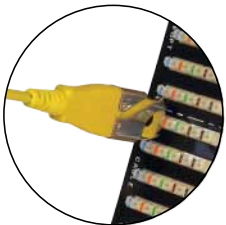


P/N: KT CAB4BK

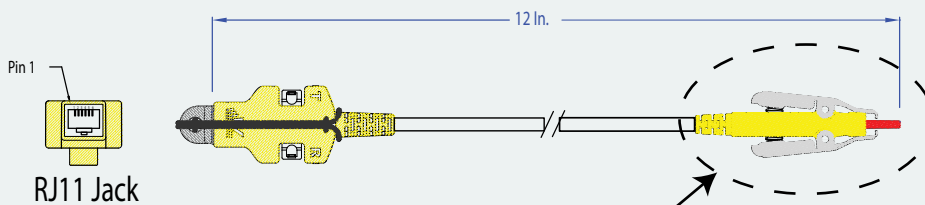
110

Call to order individual test cords :

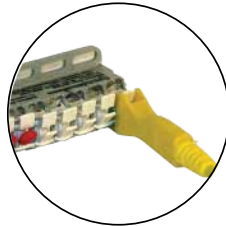
2827



Dat Term



Self Strip



526

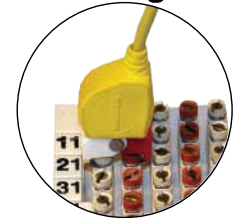
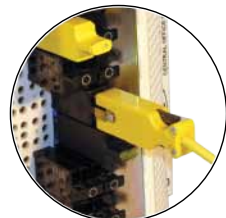
How to Order:

P/N TC-OSP(H) ← Choose

- | | | |
|------------------------|------------------------|-------------------|
| a. 110 Block Probe | g. L3 526 (Light Span) | m. Bix Connector |
| b. L7 | h. Self Strip Clip | n. 5 Pin 463A |
| c. 66 Block Probe | i. LHTCAB | p. RJ-45 |
| d. Krone (Looking Out) | j. 3M #2827 Clip | q. RJ-11 |
| e. Binding Post Clip | k. Porta Single Pin | s. RLS50 |
| f. Dat Term | l. Single Bantam | t. 110 Patch Type |



Binding Post



Central Office Tech Fiber Kit

Ph: 800.526.2673 Fax: 800.526.3299

WWW.WESTEK.COM

KIT PN:
KT COTFK



LC
Single Mode UPC
MAT CODE:
1336709



SC
Single Mode UPC
MAT CODE:
1336713



*Rugged LC/SC Fiber Loopback Plugs
With Coupler and Parking Lot in
Heavy Duty Unbreakable Waterproof
Case with Lanyard*



1. Dual Male Loopback Plug

2. Dual Fiber Coupler

Dust Cover

3 Tools In One Kit!



3. Dual Female Loopback Plug

4. Park your exposed fiber ends
keeping them clean and damage free

PATENTED

Fiber Install & Removal Tool with Built in Flashlight



FOR FIBER OPTIC SC/LC PLUG
INSERTION AND REMOVAL



KIT BAG INCLUDED
FOR EASY TRANSPORT



OSP Construction Fiber Kit

Ph: 800.526.2673 Fax: 800.526.3299

WWW.WESTEK.COM

**KIT PN:
KT CONTFK**



SC

Single Mode UPC
MAT CODE: 1336713



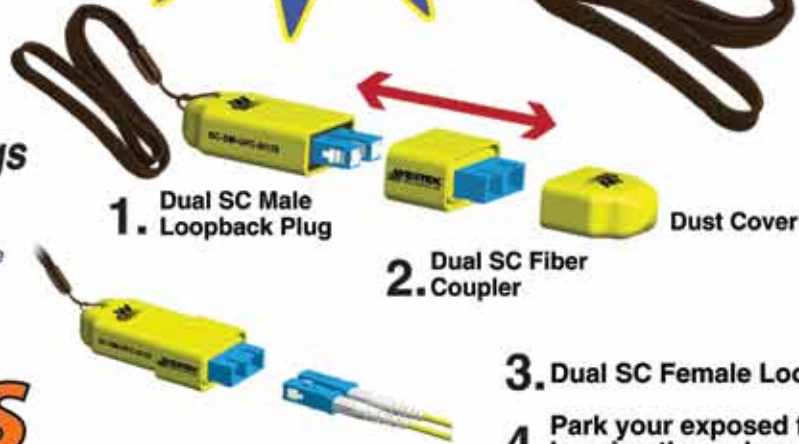
SC

Single Mode APC
MAT CODE: 1336716



SC Fiber Loopback Plugs

Rugged SC Fiber Loopback Plugs
With Coupler and Parking Lot in
Heavy Duty Unbreakable Waterproof Case
with Lanyard



1. Dual SC Male Loopback Plug

2. Dual SC Fiber Coupler

Dust Cover

3. Dual SC Female Loopback Plug

4. Park your exposed fiber ends
keeping them clean and damage free

3 Tools In One Kit!

PATENTED

Fiber Install & Removal Tool with Built in Flashlight



FOR FIBER OPTIC SC/LC PLUG
INSERTION AND REMOVAL



KIT BAG INCLUDED
FOR EASY TRANSPORT



Linesman Technician Copper Test and Repair test kit

- Test and trouble shoot Copper lines
- Install Twisted Pair lines
- Rugged test cables and connectors
- Patented designs
- Other kits available for pair bond testing and fiberoptics.
- Increase productivity quality and pair access by having all the tools



P/N: KT LINE1BL

P/N	Description
CB 05191 LGO	Carry Case
TC-BJ100-PRO	Banjo Pro with RJ11 an RJ45 Y Cable
TC-SD100	Screw Driver 2 in 1
TC-TLTS 1A	Tel-line tester
TC-162241	L4 to to L4 cradle
TC-OSPE	RJ11 female Clip Access to Binding post clip
TC-OSPH	RJ11 female Clip Access to Self Strip clip
TC-RJ45LSRYEL/1	RJ45 L-Plug to RJ45 L-Plug

OSP Technician Test Access Kit
- Network Interface Device "NID"
- Serving Area Interface "SAI" box

P/N: KT LINEBLCL3

Banjo Pro



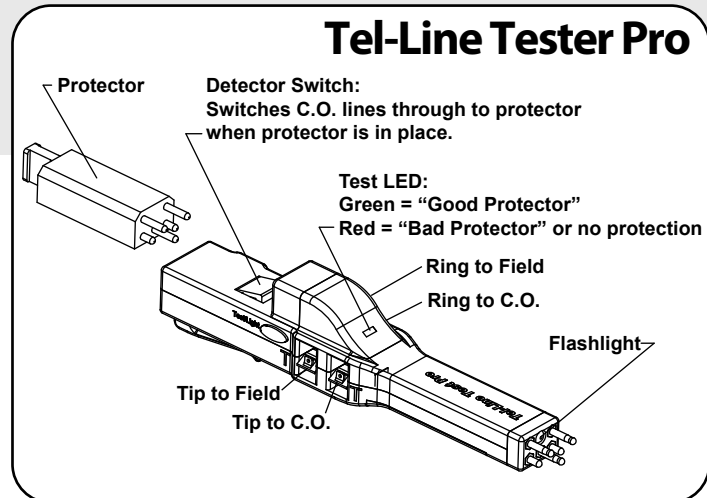
- Data Testing -
 Plug in **Black RJ45**
 for 8 conductor testing

- POTS Testing -
 Plug in **Red RJ11**
 and "Just Flip It"
 for 2, 4, 6
 conductor testing

- Test and trouble shoot Copper lines with accurate connections.
- All your test connectors at your fingertips
- Patented components
- Reduce truck rolls and repeat repairs.
- Increase productivity quality and pair access by having all the tools

OSP combi

Contents:
Carry Case
RJ45-11 Banjo Pro with RJ11 an RJ45 Y Cable
Screw Driver 2 in 1
Tel-line tester PRO
L4 to to L4 cradle
RJ11 (F) to Y 66, RLS50, self strip, binding post



OSP Technician Test Access Kit
- Network Interface Device "NID"
- Serving Area Interface "SAI" box

WESTEK
 Electronics, Inc.
 1(800) 526-2673 www.westek.com

P/N: KT LINEBLCL4

Banjo Pro



- Data Testing -
 Plug in **Black RJ45**
 for 8 conductor testing

- POTS Testing -
 Plug in **Red RJ11**
 and "Just Flip It"
 for 2, 4, 6
 conductor testing



- **Test and trouble shoot Copper lines with accurate connections.**
- **All your test connectors at your fingertips**
- **Patented components**
- **Reduce truck rolls and repeat repairs.**
- **Increase productivity quality and pair access by having all the tools**

OSP combi

Contents:
Carry Case
RJ45-11 Banjo Pro with RJ11 an RJ45 Y Cable
Screw Driver 2 in 1
Tel-line tester
L4 to to L4 cradle
RJ11 (F) to Y 66, RLS50, self strip, binding post

OSP Technician Test Access Kit
- Network Interface Device "NID"
- Serving Area Interface "SAI" box

WESTEK
Electronics, Inc.
1(800) 526-2673 www.westek.com

P/N: KT LINEBLCL5



- Test and trouble shoot Copper lines with accurate connections.
- All your test connectors at your fingertips
- Patented components
- Reduce truck rolls and repeat repairs.
- Increase productivity quality and pair access by having all the tools

OSP combi

Contents:
Carry Case
Screw Driver 2 in 1
Tel-line tester
L4 to to L4 cradle
RJ11 Female to Y 66, RLS50, self strip, binding post,



800.526.2673 www.westek.com

TL9000

Bicsi

“Streamlining Technician Productivity”

OSP Pair Bonding

Test Cords

Patented

Patented
Unbreakable RJ45



PIN TC-PB2J



PIN TC-PB2H



2827

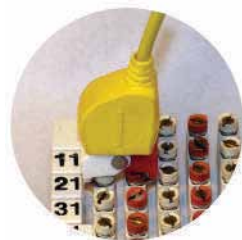


Self Strip



PIN TC-PB2E

Binding Post





800.526.2673 www.westek.com

TL9000

Bicsi

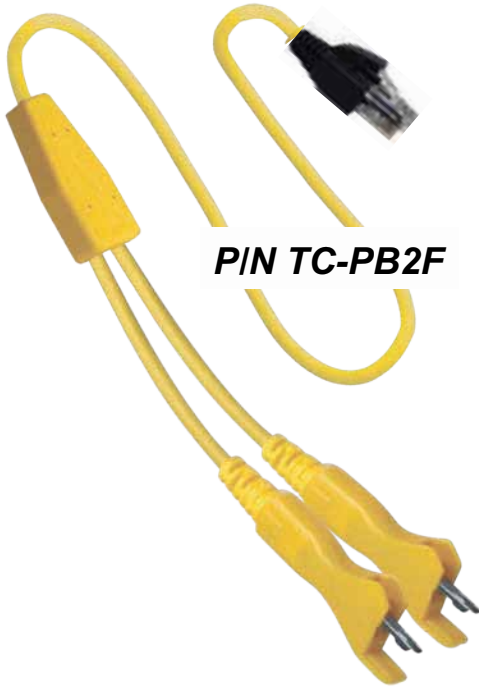
“Streamlining Technician Productivity”

OSP Pair Bonding

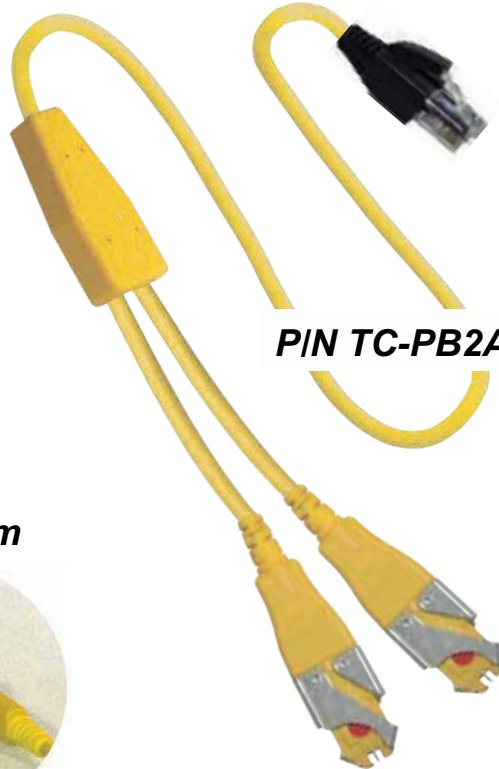
Test Cords

Patented

Patented
Unbreakable RJ45



PIN TC-PB2F

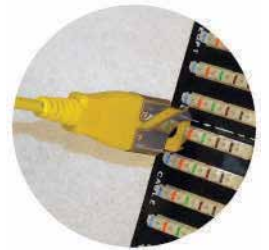


PIN TC-PB2A

Dat Term

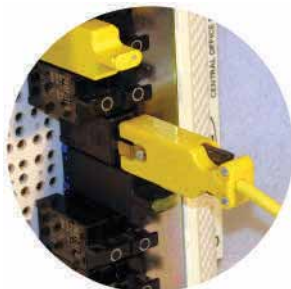


110



PIN TC-PB2G

526



Linesman Technician Copper Test and Repair Kit: Line 3

- Network Interface Device "NID"

- Serving Area Interface "SAI" box

P/N: KT LINE3BK



1(800) 526-2673 www.westek.com

- Test and trouble shoot Copper lines with accurate connections.
- All your test connectors at your fingertips
- Patented components
- Reduce truck rolls and repeat repairs.
- Increase productivity quality and pair access by having all the tools



Banjo Pro



Just Flip It.

- Data Testing - Plug in **Black RJ45** for 8 conductor testing

- POTS Testing - Plug in **Red RJ11** and "Just Flip It" for 2, 4, 6 conductor testing



P/N: KT LINE3BK

P/N	Description
CB TLA153228	TLA Utility Bag
TC-BJ100-PRO	BanjoPro w/Y cable RJ11 and RJ45 plug
TC-MOSPE	RJ45 to Binding post clip
TC-MOSPH	RJ45 to SelfStrip
TC-MOSPJ	RJ45 to 2827 clip
TC-MOSPF	RJ45 to Dat Termclip
TC-MOSPS	RJ45 to RLS50
TC-CW216	216 Can Wrench

Linesman Technician Copper Test and Repair Kit: Line 2

- Network Interface Device "NID"

- Serving Area Interface "SAI" box

P/N: KT LINE2BK



1(800) 526-2673 www.westek.com

- Test and trouble shoot Copper lines with accurate connections.
- All your test connectors at your fingertips
- Patented components
- Reduce truck rolls and repeat repairs.
- Increase productivity quality and pair access by having all the tools



Banjo Pro



Just Flip It.

- Data Testing - Plug in **Black RJ45** for 8 conductor testing

- POTS Testing - Plug in **Red RJ11** and "Just Flip It" for 2, 4, 6 conductor testing



P/N: KT LINE2BK

P/N	Description
CB TLA153228	TLA Utility Bag
TC-BJ100-PRO	BanjoPro w/Y cable RJ11 and RJ45 plug
TC-MOSPE	RJ45 to Binding post clip
TC-MOSPH	RJ45 to SelfStrip
TC-CW216	216 Can Wrench

Linesman Technician Copper Test and Repair Kit: Line 1

- Network Interface Device "NID"

- Serving Area Interface "SAI" box

P/N: KT LINE1BK



1(800) 526-2673 www.westek.com

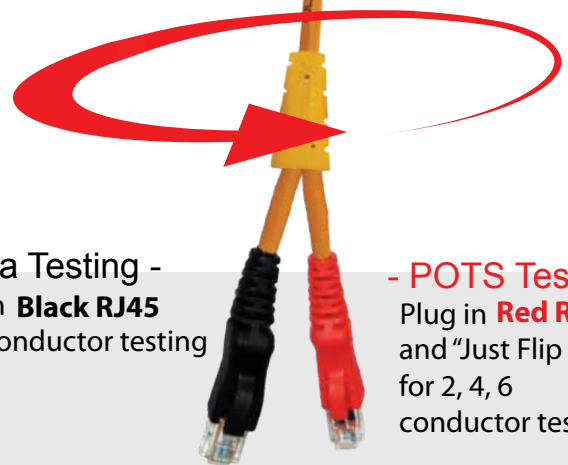
- Test and trouble shoot Copper lines with accurate connections.
- All your test connectors at your fingertips
- Patented components
- Reduce truck rolls and repeat repairs.
- Increase productivity quality and pair access by having all the tools



Banjo Pro



Just Flip It.



- Data Testing - Plug in **Black RJ45** for 8 conductor testing

- POTS Testing - Plug in **Red RJ11** and "Just Flip It" for 2, 4, 6 conductor testing



P/N: KT LINE1BK

P/N	Description
CB TLA153228	TLA Utility Bag
TC-BJ100-PRO	BanjoPro w/Y cable RJ11 and RJ45 plug
TC-MOSPE	RJ45 to Binding post clip
TC-CW216	216 Can Wrench

PATENT PEND.

PORTABLE UNIVERSAL FIBER SPLICE WORKSTATION

TIME SAVINGS & SAFETY

PN: KT FULLWKS



Truck Mount



MDU Cabinet Mount

Fusion Splicer Secured with Standard Mount Knob



Bucket Mount



Tripod Mount




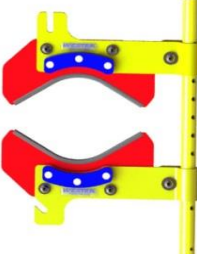
-FOSC- 400/450 Series & Other Splice Cases

WESTEK
Electronics, Inc.


1(800) 526-2673 www.westek.com


Ph: 800.526.2673 | Fax: 800.526.3299 | www.westek.com | 185 Westridge Drive, Watsonville CA 95076


Westek Electronics Inc. FOSC Work station


KT CLAMP11	Description	Function	
	<p>11in clamp, FOSC V2 with FOSC adapter tube and Vise</p>	<p>Creates a stable work platform. Works with Westek FOSC brackets, vise, fiber wrk tray, and fixturing brackets.</p>	
	<p>18in clamp, FOSC V2 with FOSC adapter tube and Vise</p>	<p>Creates a stable work platform. Works with Westek FOSC brackets, vise, fiber wrk tray, and fixturing brackets.</p>	
	<p>Table mount and FOSC vise kit.</p>	<p>Designed to be permanently mounted to the fiber workstation in the trailer and wall mounted in MDU closets. Creates a stable work platform. Works with Westek FOSC brackets, clamps, fiber wrk tray, and fixturing brackets.</p>	
	<p>FOSC Universal end plate fixture.</p>	<p>3 in 1 FOSC splice case tray mounting brackets for multiple manufacturers fiber splice cases. 3in 1 supports TYCE (Commscope) and PLP (COYOTE). Color coded for identification. Includes post adapter.</p>	

Westek Electronics Inc. FOSC Work station


KT TRAY1	Description	Function	
	<p>Fiber splicing work tray, standard 16 3/8in x 12 with adapter posts.</p>	<p>Used for fiber splicing, includes multiple mounting holes for fusion splicers. Adapter posts mount to Westek fiber work tray and 710 punchdown. Mates with Westek table top mount, FOSC clamps, brackets, and tripods.</p>	


KT TRAY2	Description	Function	
	<p>Fiber splicing work tray, Large 24i n x 12 with adapter posts.</p>	<p>Used for fiber splicing, includes multiple mounting holes for fusion splicers. Adapter posts mount to Westek fiber work tray and 710 punchdown. Mates with Westek table top mount, FOSC clamps, brackets, and tripods.</p>	


KT TRAYMT	Description	Function	
	<p>Wall mount MDU work station with fiber splicing work tray, standard 16 3/8in x 12 with adapter posts.</p>	<p>Used for fiber splicing, includes multiple mounting holes for fusion splicers. Adapter posts mount to Westek fiber work tray and 710 punchdown. Mates with Westek table top mount, FOSC clamps, brackets, and tripods.</p>	


KT TRAY2MT	Description	Function	
	<p>Wall mount MDU work station with fiber splicing work tray, Large 24i n x 12 with adapter posts.</p>	<p>Used for fiber splicing, includes multiple mounting holes for fusion splicers. Adapter posts mount to Westek fiber work tray and 710 punchdown. Mates with Westek table top mount, FOSC clamps, brackets, and tripods.</p>	

Westek Electronics Inc. FOSC Work station



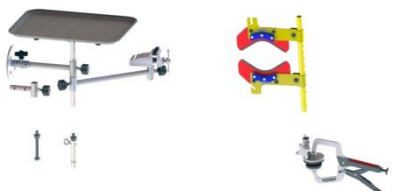

KT CL18TB	Description	Function	
	Bucket workstation with 18in FOSC clamp and fiber splicing work tray, Standard 16 3/8in x 12.	Designed to clamp on to buckets for servicing FOSC and other aerial equipment.	



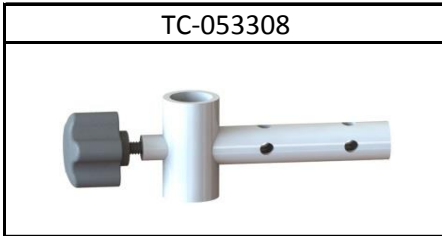

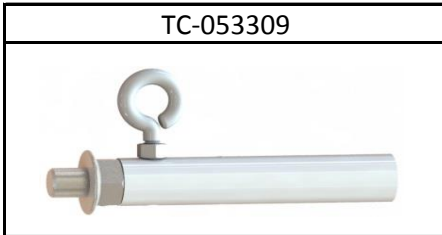


KT CL18T2B	Description	Function	
	Bucket workstation with with 18in FOSC clamp and fiber splicing work tray, Large 24in x 12.	Designed to clamp on to buckets for servicing FOSC and other aerial equipment.	

KT CL11TB	Description	Function	
	Bucket workstation with with 11in FOSC clamp and fiber splicing work tray, standard 16 3/8in x 12.	Designed to clamp on to buckets for servicing FOSC and other aerial equipment.	







KT CL11T2B	Description	Function	
	Bucket workstation with with 11in FOSC clamp and fiber splicing work tray, Large 24in x 12.	Designed to clamp on to buckets for servicing FOSC and other aerial equipment.	





Westek Electronics Inc. FOSC Work station


KT CL11TMT	Description	Function	
	<p>Deluxe fiber splicing work station, standard tray 16 3/8in x 12, 11in FOSC clamp, wall mount, and 3 in 1 FOSC endplate fixture kit, and fixturing adapters.</p>	<p>Fully adjustable workstation can be mounted in many locations for servicing FOSC enclosures and fusion splicing.</p>	
	<p>Deluxe fiber splicing work station, standard tray 16 3/8in x 12, 18in FOSC clamp, wall mount, and 3 in 1 FOSC endplate fixture kit, and fixturing adapters</p>	<p>Fully adjustable workstation can be mounted in many locations for servicing FOSC enclosures and fusion splicing.</p>	
	<p>Deluxe fiber splicing work station, large tray 24in x 12, 11in FOSC clamp, wall mount, and 3 in 1 FOSC endplate fixture kit, and fixturing adapters.</p>	<p>Fully adjustable workstation can be mounted in many locations for servicing FOSC enclosures and fusion splicing.</p>	
	<p>Deluxe fiber splicing work station, large tray 24in x 12, 18in FOSC clamp, wall mount, and 3 in 1 FOSC endplate fixture kit, and fixturing adapters</p>	<p>Fully adjustable workstation can be mounted in many locations for servicing FOSC enclosures and fusion splicing.</p>	


	<p>TC-053301</p> <p>Description</p> <p>Extension tube, 12in F-F</p>	<p>Function</p> <p>Workstation extension arm. Adapts to workstation posts to support Westek vise, lights, brackets, and accessories.</p>	
	<p>TC-053302</p> <p>Description</p> <p>90degree extension tube, 9in M-F</p>	<p>Function</p> <p>Designed to position fiber work tray away from mounting wall in MDU telecom closets. Works with Westek table mount, FOSC clamps, and fixturing brackets.</p>	
	<p>TC-053308</p> <p>Description</p> <p>90degree extension tube, 3in M-F</p>	<p>Function</p> <p>Designed to position fiber work tray away from mounting wall in MDU telecom closets. Works with Westek table mount, FOSC clamps, and fixturing brackets.</p>	
	<p>TC-053310</p> <p>Description</p> <p>Work tray adapter post, Tray, 710, long.</p>	<p>Function</p> <p>Male thread mounts to Westek fiber splice tray and 710 punchdown. Mates with Westek table mount, FOSC clamps, and fixturing brackets.</p>	
	<p>TC-053309</p> <p>Description</p> <p>Work tray adapter post, Tray, 710, short.</p>	<p>Function</p> <p>Male thread mounts to Westek fiber splice tray and 710 punchdown. Mates with Westek table mount, FOSC clamps, and fixturing brackets.</p>	
	<p>TC-053316</p> <p>Description</p> <p>Work tray adapter post, Tray, 710 to tri-pod, short.</p>	<p>Function</p> <p>Male thread mounts to Westek fiber splice tray and 710 punchdown. Male stud mates with 3M tri-pod.</p>	
	<p>MH 053315</p> <p>Description</p> <p>Large 5in diameter clamp pad with tube adapter for FOSC clamps.</p>	<p>Function</p> <p>Large footprint provides increased workstation stability for bucket mounting and other applications</p>	


Westek Electronics Inc. FOSC Work station


TC-TRIPOD	Description	Function	
	<p>Work station tri-pod with retractable spike. "Patent Pending".</p>	<p>Provides a secure platform to mount westek fiber splice tray, LED flood lights, 710 punchdown, and other accessories. Retractable spike inserts into soil, snow, and gravel for additional stability.</p>	
TC-CLAMP11	Description	Function	
	<p>11in clamp, FOSC V2 w/tube adapter.</p>	<p>Creates a stable work platform. Works with Westek FOSC fixturing brackets, vise, fiber work tray, and FOSC end plate fixtures.</p>	
TC-CLAMP18	Description	Function	
	<p>18in clamp, FOSC V2 w/tube adapter.</p>	<p>Creates a stable work platform. Works with Westek FOSC fixturing brackets, vise, fiber work tray, and FOSC end plate fixtures.</p>	
TC-TRAY	Description	Function	
	<p>Fiber splicing work tray, 16 3/8in x 12in.</p>	<p>Fiber splicing portable work station table with support holes to secure fusion splicers. Table mounts to Westek FOSC clamps, wall mount, fixturing brackets, and tri-pods</p>	
TC-TRAY2	Description	Function	
	<p>Fiber splicing work tray, large 24in x 12in.</p>	<p>Fiber splicing portable work station table with support holes to secure fusion splicers. Table mounts to Westek FOSC clamps, wall mount, fixturing brackets, and tri-pods</p>	
TC-053307	Description	Function	
	<p>Clip on tray for fiber cleaning products</p>	<p>Securely mounts to Westek fiber splice trays. Holds fiber cleaning and prep products for easy access while fusion splicing.</p>	


TC-TTMOUNT	Description	Function	
	<p>Wall/table mount FOSC post receiver</p>	<p>Designed to be mounted to the fiber workstation table in the trailer and wall mounted in MDU closets. Creates a stable work platform. Works with Westek FOSC brackets, vise, fiber splice tray, and fixturing brackets.</p>	
TC-VISE	Description	Function	
	<p>Vise, FOSC</p>	<p>Multi purpose vise for use with mounting FOSC trays for servicing. Mounts to Westek FOSC clamps, table mount, and fixturing brackets.</p>	
TC-TUBE	Description	Function	
	<p>FOSC adapter tube</p>	<p>Works with standard FOSC brackets/ fixtures and Westek end plate fixtures. Mounts to Westek FOSC clamps, table mount, and fixturing brackets.</p>	
TC-SC3	Description	Function	
	<p>FOSC universal end plate fixture.</p>	<p>3 in 1 FOSC splice case tray mounting brackets for multiple manufacturers fiber splice cases. 3in 1 supports TYCE (Commscope) and PLP (COYOTE). Color coded for identification.</p>	


TC-LEDFLDSMALL	Description	Function	
	<p>Portable 1500 lumen LED flood light w/ magnetic base and aerial strand mount. 9-15hr runtime, 4hr charge time. Includes 100 wall and 12v car charger.</p>	<p>9-15hrs runtime, 4hr charge time. Light weight heavy duty Lexan type non-yellowing lens (unbreakable). Heavy duty frame with (3x) 112lb neodymium magnets withstands 100mph winds. Mounts on aerial strand.</p>	


TC-LEDFLDLARGE	Description	Function	
	<p>Portable 4500 lumen LED flood light w/ magnetic base and aerial strand mount. -14hr runtime, 8hr charge time. Includes 100 wall and 12v car charger.</p>	<p>8-14hrs runtime, 8hr charge time. Light weight heavy duty Lexan type non-yellowing lens (unbreakable). Heavy duty frame with (6x) 112lb neodymium magnets.</p>	


KT LEDFLDHC	Description	Function	
	<p>Patent Pending 1500 lumen LED flood light with spring clamp and bracket adapters.</p>	<p>spring clamp attaches to safety rails, ladder rungs, and 2x4's. Bracket adapters mate with Westek clamp, FOSC tube, table mount, and fixturing brackets.</p>	

KT LEDDLA	Description	Function	
	<p>Kit, 4500 Lumen LED flood light with aerial strand mount bracket.</p>	<p>9-15hrs runtime, 8hr charge time. Light weight heavy duty Lexan type non-yellowing lens (unbreakable). Heavy duty frame with (6x) 112lb neodymium magnets. Provides secure mounting to aerial strand and utility pole.</p>	

KT CL11DLEDS	Description	Function	
	<p>11in clamp with dual light bracket and (2x) 1500 lumen LED flood lights.</p>	<p>Portable dual lighting system designed to clamp on to a variety of surfaces and easily adjust the light flood beams.</p>	

KT CL18DLEDS	Description	Function	
	<p>18in clamp with dual light bracket and (2x) 1500 lumen LED flood lights.</p>	<p>Portable dual lighting system designed to clamp on to a variety of surfaces and easily adjust the light flood beams.</p>	

KT CL11DLEDL	Description	Function	
	<p>11in clamp with dual light bracket and (2x) 4500 lumen LED flood lights.</p>	<p>Portable dual lighting system designed to clamp on to a variety of surfaces and easily adjust the light flood beams.</p>	

KT CL18DLEDL	Description	Function	
	<p>18in clamp with dual light bracket and (2x) 4500 lumen LED flood lights.</p>	<p>Portable dual lighting system designed to clamp on to a variety of surfaces and easily adjust the light flood beams.</p>	

TC-HANDCLAMP	Description	Function	
	<p>Patent pending spring clamp with molded tips, for 1500 lumen LED flood light.</p>	<p>Secures 1500 lumen flood light to safety rails, ladder rungs, and 2x4's.</p>	
KT LEDADPT	Description	Function	
	<p>Light adapter kit, 1500 and 4500 lumen LED flood lights.</p>	<p>Adapts 1500 and 4500 lumen LED lights to mount into Westek FOSC clamps, table mount, tri-pod, and fixturing brackets.</p>	
KT LEDADPT2	Description	Function	
	<p>Dual flood light bracket kit w/ 90 degree adapter.</p>	<p>Allows mounting of two 1500 lumen LED flood lights to Westek FOSC clamps, table mount, tri-pod, and fixturing brackets.</p>	
CB 05192 CLP	Description	Function	
	<p>FOSC clamp and accessory bag</p>	<p>Allows mounting of two 1500 lumen LED flood lights to Westek FOSC clamps, table mount, tri-pod, and fixturing brackets.</p>	
CB TRAVEL	Description	Function	
	<p>FOSC technician travel case with retractable handle and wheels.</p>		

OUTSIDE PLANT

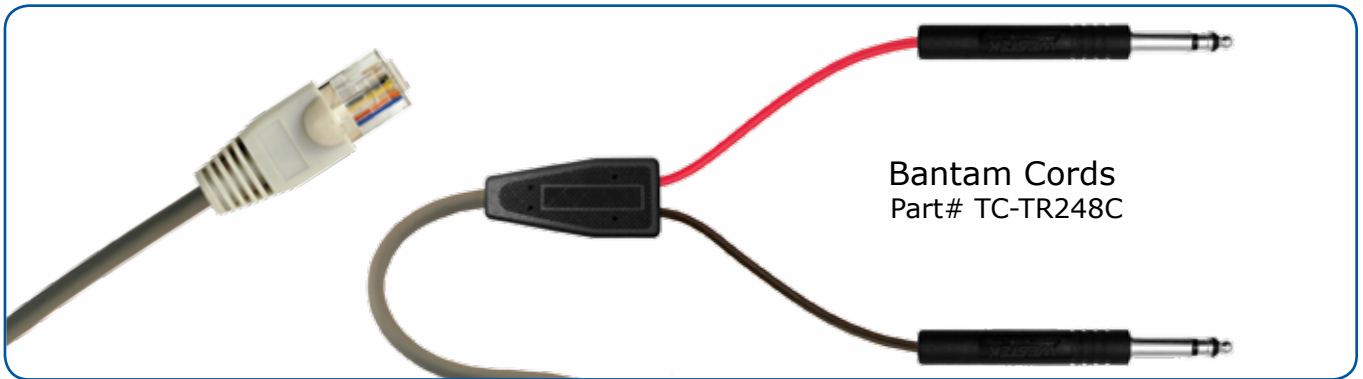
Test right the first time with Westek's patented tools.



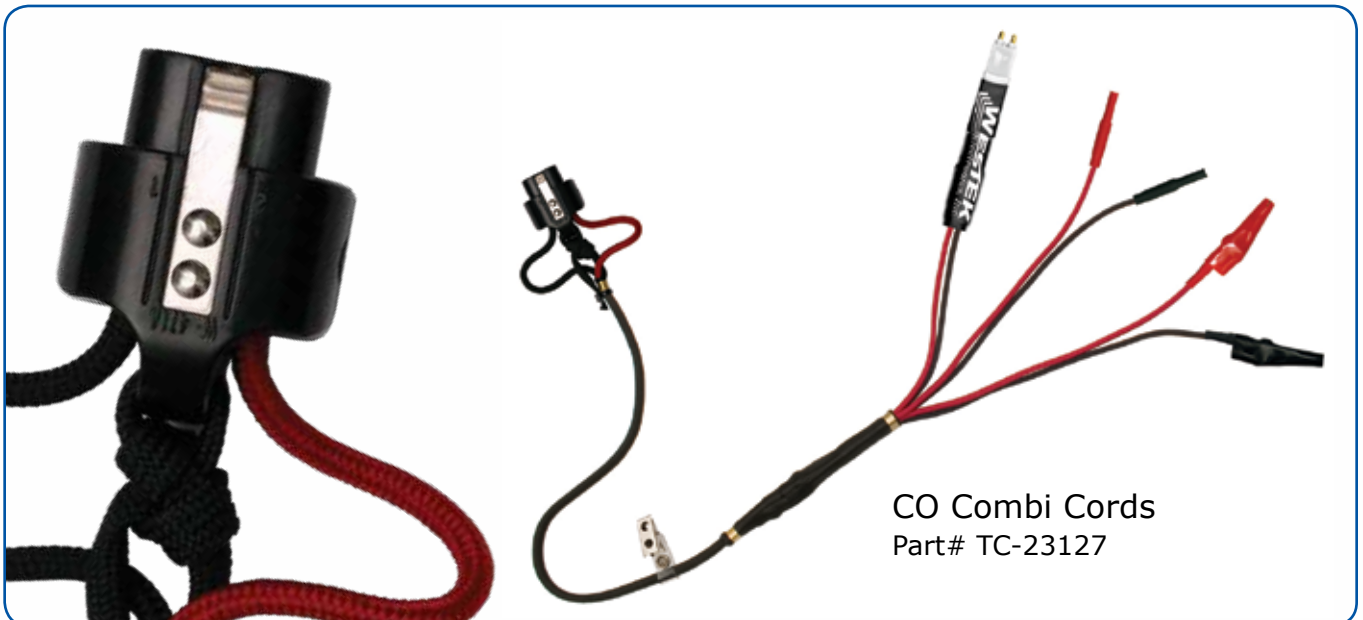
Laptop Kit
Part# KT 290152



NIU Kit
Part# KT 291064



Bantam Cords
Part# TC-TR248C



CO Combi Cords
Part# TC-23127

OUTSIDE PLANT

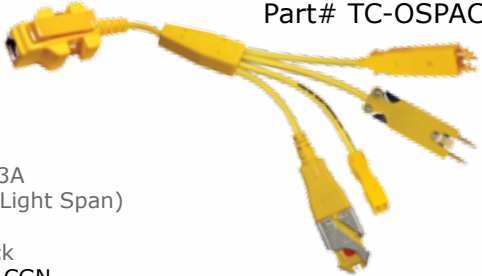
Test right the first time with Westek's patented tools.



800.526.2673 www.westek.com


TL9000 ISO 9001:2008 Bicsi

OSP Combi-Cord
Part# TC-OSPACGN

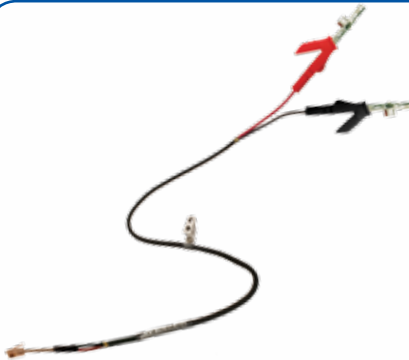


5 Pin 463A
L3 526 (Light Span)
66 Block
110 Block
TC-OSPACGN

OSP Combi-Cord
Part# TC-OSPEFHQ



RJ11 LE
Dat Term
Binding Post Clip
Self Strip Clip
TC-OSPEFHQ

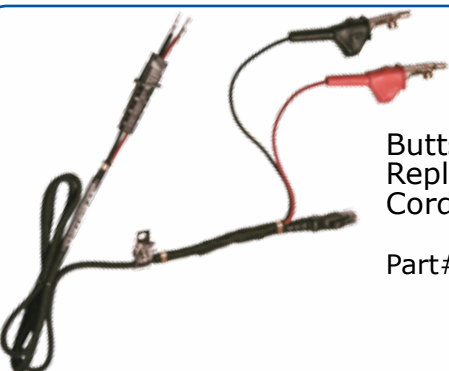


RJ11 to Heavy Test
Clips, with Bed of
Nails and Pin

Part# TC-611LTBP/5
Part# TC-611LTBP/8



Tel-Line Tester Pro
Part# KT 291052



**Buttset
Replacement
Cord**

Part# TC-162202



**RFL Test Set
Replacement
Cords**

Part# KT Banana

OUTSIDE PLANT COMBI-CORD

TC-OSPAEFH

OSP Combi-Cord

Isolated Self Strip

Binding Post Clip

Dat-Term Clip

110 Block



The OSP Combi-Cord reduces truck rolls, saves time and promotes productivity by having all of the necessary plug-in's on a one foot cord. Our cords are manufactured to the highest industry standard, proving themselves to be ultra durable. **The OSP Combi-Cord is new to the market and available in multiple combinations exclusively from Westek.** Westek's OSP Combi-Cord features a 2 year warranty and excellent Westek Customer Service.



800.526.2673 www.westek.com

TL9000 ISO 9001:2008 *Bicsi*

OUTSIDE PLANT COMBI-CORD



TC-OSPACGN

OSP Combi-Cord

110 Block

66 Block

L3 526

5 Pin 463A



TC-OSPDEGH

OSP Combi-Cord

Isolated Self Strip

Binding Post Clip

L3 526

Krone [looking in]



TC-OSPCDEH

OSP Combi-Cord

66 Block Probe

Krone [looking out]

Binding Post Clip

Self Strip Clip

OUTSIDE PLANT COMBI-CORD



TC-OSPAENQ

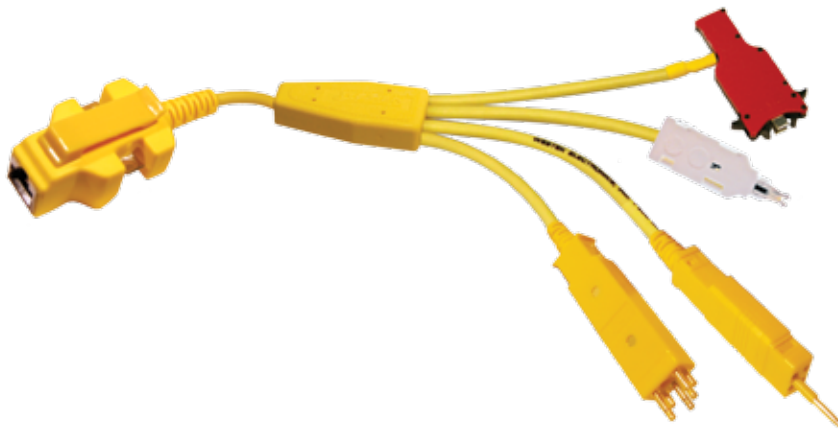
OSP Combi-Cord

110 Block

Binding Post Clip

5 Pin 463A

RJ11



TC-OSPDKNM

OSP Combi-Cord

5 Pin 463A

Porta SinglePin

Krone

Bix



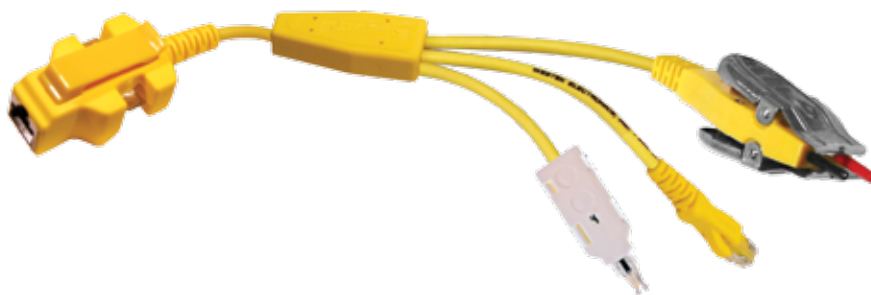
TC-OSCNP

OSP Combi-Cord

RJ11

66 Block

5 PIN 463A



TC-OSPDHQ

OSP Combi-Cord

Krone

Self Strip Clip

RJ11

OUTSIDE PLANT COMBI-CORD



TC-OSPEFHJ
OSP Combi-Cord
Isolated Self Strip
Binding Post Clip
3M
Dat Term



TC-OSPEFHQ
OSP Combi-Cord
Isolated Self Strip
Binding Post Clip
Dat Term
RJ11



TC-OSPCEFH
OSP Combi-Cord
Isolated Self Strip
Binding Post Clip
Dat Term
66 Block

OUTSIDE PLANT COMBI-CORD



TC-OSPBGN/IN

OSP Combi-Cord

Chuck Ends

526

5 PIN 463A



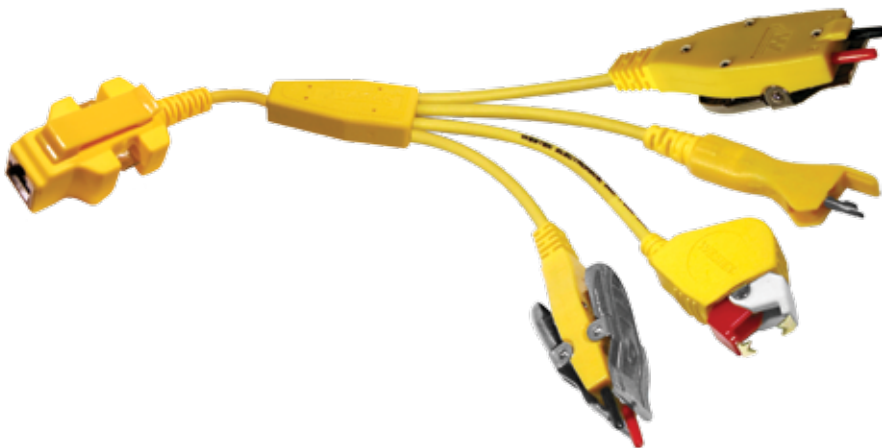
TC-OSPBLN/IN

OSP Combi-Cord

5 Pin 463A

Chuck Ends

Bantam



TC-OSPEFHS

OSP Combi-Cord

Isolated Self Strip

Binding Post Clip

Dat-Term Clip

RLS50



TC-OSPENQT

OSP Combi-Cord

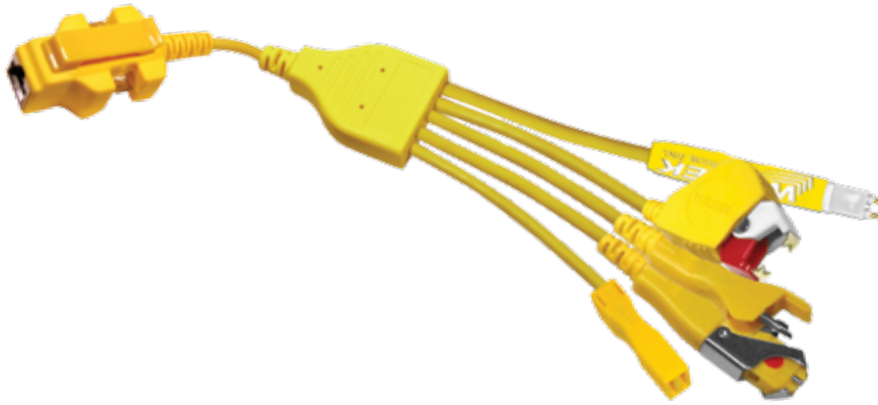
110 Block_legacy

Binding Post Clip

5 Pin 463A

RJ11

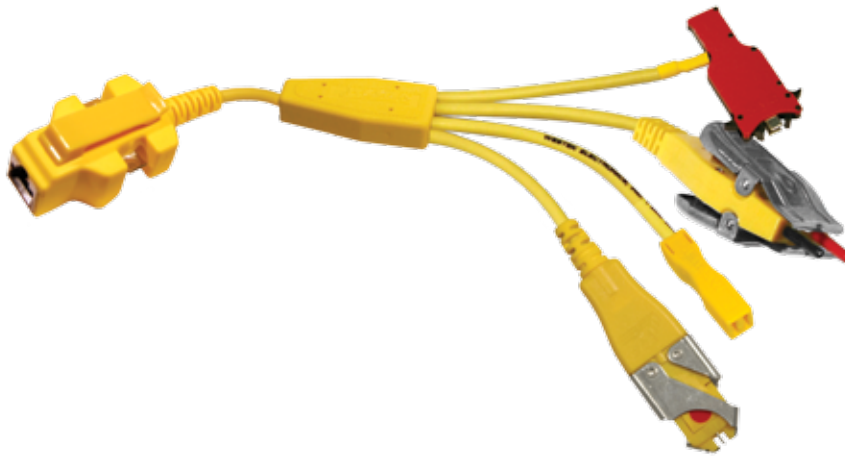
OUTSIDE PLANT COMBI-CORD



TC-OSPACEFR

OSP Combi-Cord

P2EF
Binding Post Clip
Dat Term
110 Block Probe
66 Block Probe



TC-OSPACHM

OSP Combi-Cord

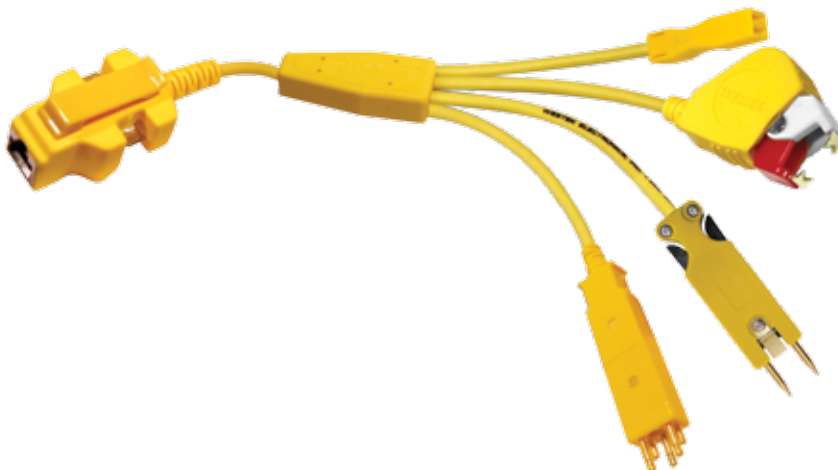
110 Block
66 Block
Self Strip Clip
Bix Connector



TC-OSPAEFR

OSP Combi-Cord

P2EF
Binding Post Clip
Dat-Term Clip
110 Block



TC-OSPCEGN

OSP Combi-Cord

66 Block Probe
Binding Post Clip
526 (Light Span)
5 Pin 463A

Banjo Pro

Three tools in one.



TC-BJ100-PRO



Just Flip It.

Save money, time, and space with the three in one convenience of Westek's NEW *Banjo Pro!*

Featuring our Unbreakable Banjo Pro Cable

- Data Testing -
Plug in **Black RJ45** for 8 conductor testing

- POTS Testing -
Plug in **Red RJ11** and "Just Flip It" for 2, 4, 6 conductor testing

BANJO REPLACEMENT CORDS



New Patented Replacement Cables for Six Position Banjo

The new patented RJ11 and RJ45 modular plug boots now make Westek's banjo cords ultra durable.

Save money by not having to buy traditional banjo cords over and over again.

**Sold in Packs of 5
6" or 3"**

KT-RJ11LE5PK/6"

KT-RJ11LE5PK/3"

KT-RJ45LE5PK/6"

KT-RJ45LE5PK/3"

Westek's Banjo Kit with Unbreakable Cord

More durable, less expensive, guaranteed.



TC-BJ100Y45

TC-BJ100Y11

Available in Six Position or Eight Position

**Featuring our
Unbreakable
Connector**

TEL-LINE TESTER PRO™

Troubleshoot Cable Pairs Fast and with Protection.

A patented important time saving tool for cable maintenance. Now troubleshoot cable pairs in seconds and eliminate repeat repairs. Look into the central office or out to the field in seconds.

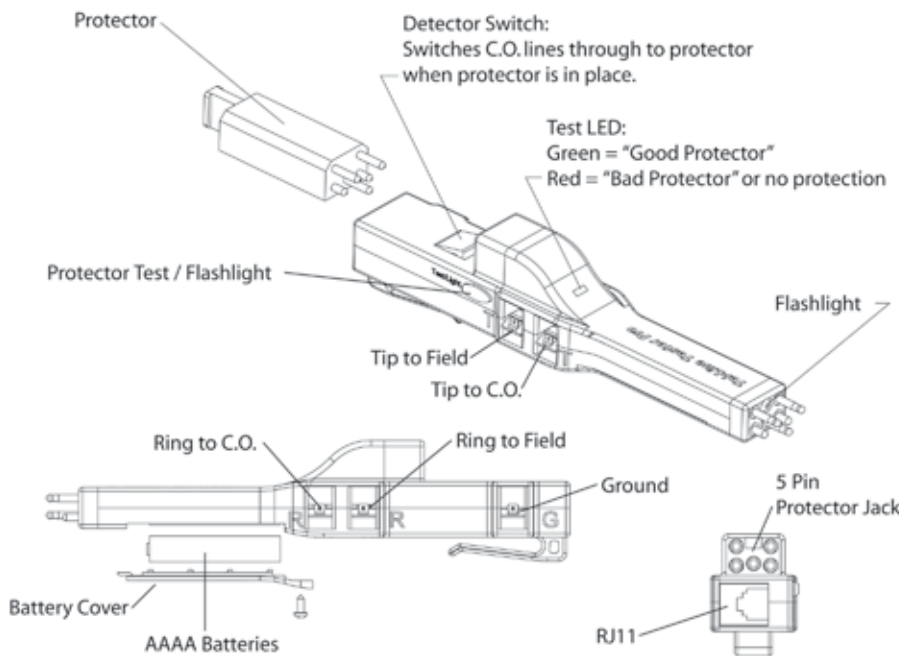
The Tel-Line Tester Pro™ automatically splits the central office from the field. Access cable pairs by plugging into any five pin connector block located at the building entrance (SLC remote, CEV, or central office).

To troubleshoot the switch, simply clip a buttset or voltmeter to the metal tabs marked "Tip" and "Ring In" and look to the switch. Move the clips to the tabs marked "Tip" and "Ring Out" and look to the field. To restore temporary service to the customer while troubleshooting, simply plug in the OSP kit's modular looping tool. Westek's Tel-Line Tester Pro™ facilitates Bell System Practice (BSP). Connect a Craft access terminal or Trans Test Access Network to close out the trouble and pull up the next job ticket.

Adding a protector module to the Tel-Line Tester Pro™ enables access to the central office's wiring. It also protects temporary service restoration and monitoring capability using Westek's modular looping tool (P/N TC-TLTS-12).



Tel-Line Tester Pro™ TC-TLTS-PRO



PRODUCT HIGHLIGHTS

- Access 5 pin location at building entrance, CEV, SLC remote, and Central Office with protection
- Isolate Central Office from field
- No need to disconnect pairs
- Test Protector Modules
- Flashlight

RJ11 Jack Front Face

- Pin 1: N/C
- Pin 2: Ring to Field
- Pin 3: Tip to C.O.
- Pin 4: Ring to C.O.
- Pin 5: Tip to Field
- Pin 6: Ground



5 Pin Plug (male) Front Face

- Long Pin (Gold) Ring To Field
- Short Pin (Gold) Ring to C.O.
- LED
- Long Pin (Silver) Ground
- Long Pin (Gold) Tip to Field
- Short Pin (Gold) Tip to C.O.

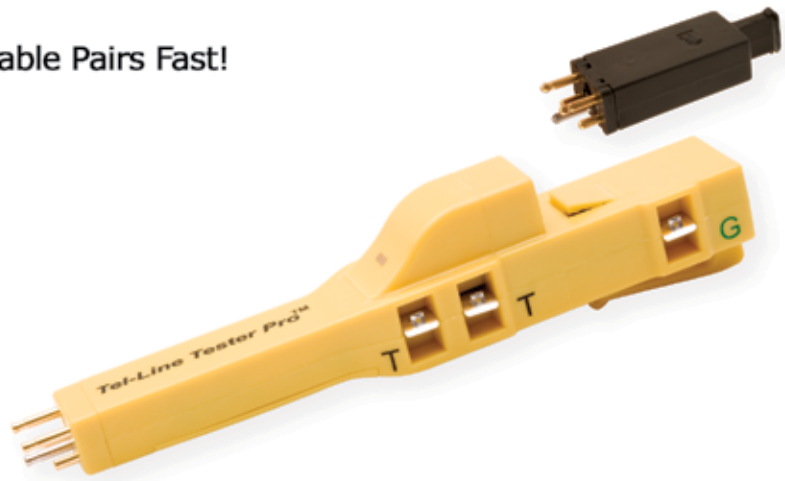
DELUXE TEL-LINE TESTER PRO™ KIT

OSP Troubleshooting Kit Technicians Can Now Troubleshoot Cable Pairs Fast!

A patented important time saving tool kit for cable maintenance. Now troubleshoot cable pairs in seconds and eliminate repeat repairs. Look into the central office or out to the field in seconds.

The Tel-Line Tester Pro™ automatically splits the central office from the field. Access cable pairs by plugging into any five pin connector block located at the building entrance (SLC remote, CEV, or central office).

To troubleshoot the switch, simply clip a buttset or voltmeter to the metal tabs marked "Tip" and "Ring In" and look to the switch. Move the clips to the tabs marked "Tip" and "Ring Out" and look to the field. To restore temporary service to the customer while troubleshooting, simply plug in the OSP kit's modular looping tool. The Westek Tel-Line Tester Pro™ facilitates Bell System Practice (BSP). Connect a Craft access terminal or Trans Test Access Network to close out the trouble and pull up the next job ticket.



Deluxe Tel-Line Tester Pro™ KIT.....KT DELUXEPRO

- INCLUDES:
 TC-TLTS 1A [Tool]
 TC-TLTS-12 [Looping Tool]
 TC-TLTS-13 [RJ11 to RJ11]
 TC-TLTS-14 [Grounding Cord]
 TC-TLTS-15 [TLTS PRO Bag]
 TC-L4PEXT/30" [463A to Cradle]

Tel-Line Tester Pro™ KIT.....KT 291052

- INCLUDES:
 TC-TLTS-PRO [Tool]
 TC-LE11LOOP [RJ11 LE Looping Plug]
 TC-TLTS-14 [Ground Cord]

Tel-Line Tester Pro™.....TC-TLTS-PRO

PRODUCT HIGHLIGHTS

- Access 5 pin location at building entrance, CEV, SLC remote, and Central Office
- Isolate Central Office from field
- No need to disconnect pairs
- Built tough and durable
- Full two year warranty



Looping Tool, RJ11 TC-TLTS-12
Qty: 2



RJ11 to RJ11 (3ft) TC-TLTS-13



Grounding Cord TC-TLTS-14



Tel Line Tester with ground connector



Tel-Line Tester Pro™ Bag
CB 05190 000



TC-L4PEXT/30"

DELUXE TEL-LINE TESTER STANDARD KIT

OSP Troubleshooting Kit

Save time! Perform an 8 - 10 minute job in approximately 30 seconds.

A patented important time saving tool kit for cable maintenance. Now troubleshoot cable pairs in seconds and eliminate repeat repairs. Look into the central office or out to the field in seconds.

The Tel-Line Tester automatically splits the central office from the field. Access cable pairs by plugging into any five pin connector block located at the building entrance (SLC remote, CEV, or central office).

To troubleshoot the switch, simply clip a buttset or voltmeter to the metal tabs marked "Tip" and "Ring In" and look to the switch. Move the clips to the tabs marked "Tip" and "Ring Out" and look to the field. To restore temporary service to the customer while troubleshooting, simply plug in the OSP kit's modular looping tool.



Deluxe Tel-Line Tester Standard.....TC-TLTS2C

Includes:

- Tel-Line Tester.....TC-TLTS-1A
- TC-TLTS-12.....Looping Tool
- TC-TLTS-13.....RJ11 to RJ11
- TC-TLTS-14.....Grounding Cord
- TC-TLTS-15.....Tel-Line Tester Pro™ Bag

Accessories for your Tel-Line Tester Pro™



RJ11 to RJ11 (3ft) TC-TLTS-13



Grounding Cord TC-TLTS-14



Looping Tool TC-TLTS-12



Tel-Line Tester Pro™ Bag
TC-TLTS-15

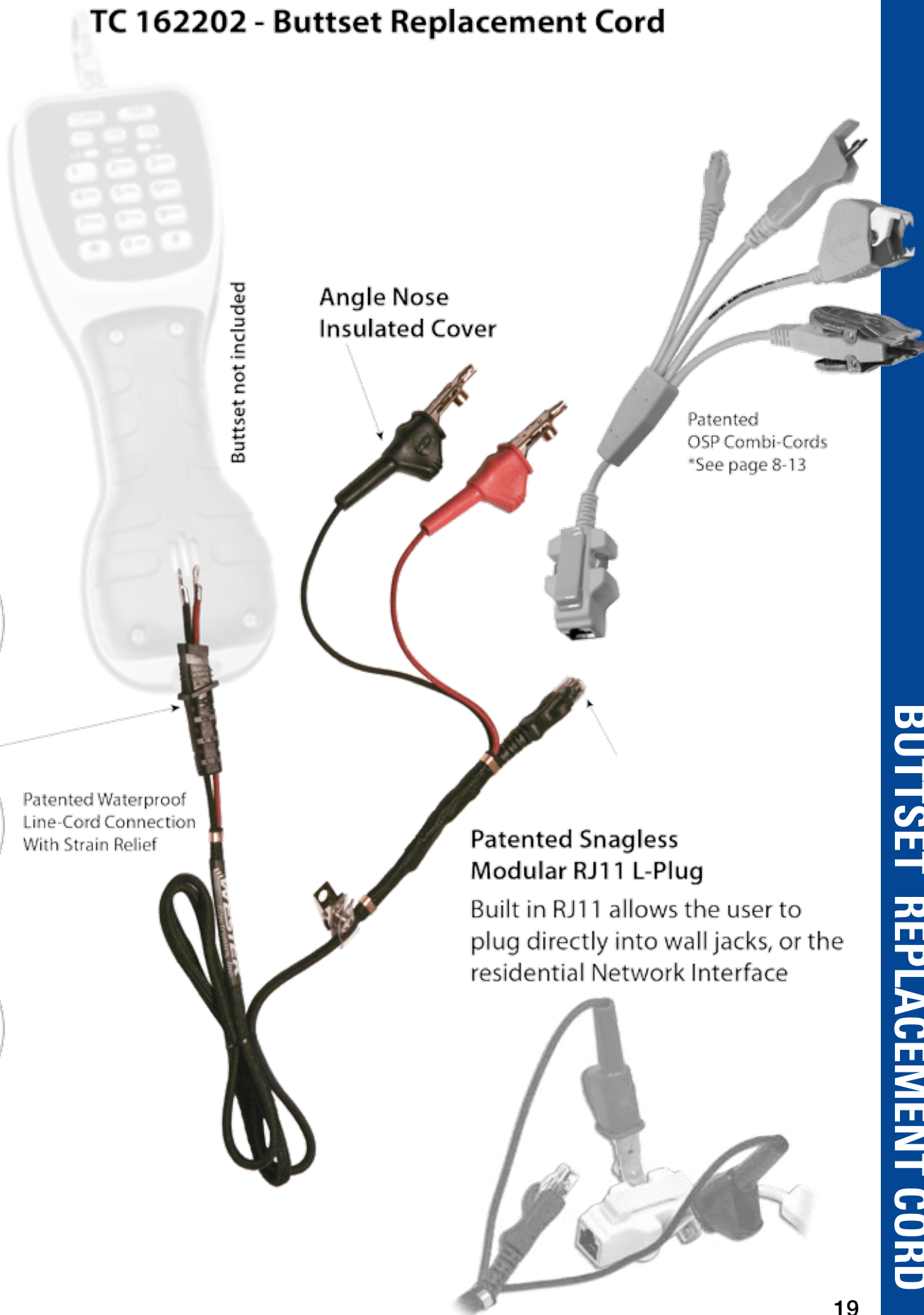
PRODUCT HIGHLIGHTS

- Access 5 pin location at building entrance, CEV, SLC remote, and Central Office
- Isolate Central Office from field
- No need to disconnect pairs
- Built tough and durable
- Full two year warranty

Buttset Replacement Cord

Patent Pending

TC 162202 - Buttset Replacement Cord



Buttset not included

Angle Nose Insulated Cover

Patented OSP Combi-Cords
*See page 8-13

TS22

TS44

Patented Waterproof Line-Cord Connection With Strain Relief

Patented Snagless Modular RJ11 L-Plug

Built in RJ11 allows the user to plug directly into wall jacks, or the residential Network Interface

Hardwired

BUTTSET REPLACEMENT CORD

LAPTOP

Laptop Kit

Westek's Laptop Kit is a time-saving solution that allows technicians to configure multiple combinations of 25 pin and 9 pin style cables in one portable easy-to-use kit. Our laptop kit allows your laptop to quickly and easily interface with T1, Ethernet, Modems, Routers, "D-Slam" units, and Comports.

KIT CONTAINS

PART NUMBERS

1-25 Male-9 Female 10ft	TC-25M9F/10
1-9 Male-9 Female 10ft	TC-9M9F/10
1-9 Female Gender Changer	TC-GCPC9F
1-9 Male Gender Changer	TC-GC9M
1-25 Female Gender Changer	TC-GCPC25M
1-25 Male Gender Changer	TC-GCPC25F
1-Null Modem 25 Female-25 Male L/P Adapter	TC-NM100LP
1-Null Modem 9 Female-9 Male L/P Adapter	TC-NM900LP
1-RJ48 Shorting Tool	TC-LPRJ48C
1-RJ48 Ethernet Looping Plug	TC-LPRH48E
1- Wrist Strap	TC-WS100
1-Flashlight	TC-FL100
1-Screwdriver	TC-SD100
Laptop Kit	KT 290152



Tech Support Laptop Kit

This kit allows technicians to configure multiple combinations for their laptop in one portable and easy to use kit. It will quickly access and interface with both DS1 and DS3 applications.

KIT CONTAINS

PART NUMBERS

1-25 Male-25 Male 3ft	TC-16493/3
1-310 TAD Blue Adapter	TC-AD310B
1-310 TAD Red Adapter	TC-AD310R
1-BAN-Mini Grabbers-Blue 8ft	TC-240TX/8
1-BAN-Mini Grabbers-Red 8ft	TC-240RX/8
1-BAN-Dual Banana 8ft	TC-204
2-Mini Grabbers-Mini Grabbers 6ft	TC-700
1-9 Female Gender Changer	TC-GCPC9F
1-9 Male Gender Changer	TC-GC9M
1-25 Female Gender Changer	TC-GCPC25F
1-25 Male Gender Changer	TC-GCPC25M
1-25 Female 25 Male Null Modem Adapter L/P	TC-NM100LP
1-9 Female 9 Male Null Modem Adapter L/P	TC-NM900LP
1-RJ48C Shorting Tool	TC-LPRJ48C
1-RJ48 Ethernet Looping Plug	TC-LPRJ48E
1-Screwdriver	TC-SD100
1-Flashlight	TC-FL100
Tech Support Laptop Kit	KT 290332



DSX1

NIU Kit

This Westek kit contains the most commonly used cables for an up to two-slot repeater card box with lug nuts.

KIT CONTAINS	PART NUMBERS
Banjo Yellow with RJ45 Lan Cord.....	TC-BJ100Y
(4) Round Lugs Y 463A (Looking In).....	TC-162140
Protect Cradle-(2) Alligator Clips, Red & Black.....	D1-250151
Protect Cradle-(2) Alligator Clips, Green & Yellow.....	D1-250151
NIU Kit.....	KT 291064



209 OSP-CO Kit

This Westek kit contains the most commonly used DS1 cables for testing the T-Berd 209 and various other test sets.

KIT CONTAINS	PART NUMBERS
1-310-Y BAN, 463A, ALG CLIPS Blue 15ft	TCC-323TX
1-310-Y BAN, 463A, ALG CLIPS Red 15ft	TCC-323RX
1-15pin Female to Y 310-2ft	TC-15F310/2
1-DBAN(Female)-310 Blue 1ft	TC-227ATX/1
1-DBAN(Female)-310 Red 1ft	TC-227ARX/1
1-BAN-ALG Clips Blue 8ft	TC-140
1-310 Red TAD Adapter	TC-AD310R
1-310 Blue TAD Adapter	TC-AD310B
1-Screwdriver	TC-SD100
1-Flashlight	TC-FL100
209 OSP-CO Kit	KT 290026



DS1 Kit

The right digital/analog test cord at your fingertips! This DSX 1 test kit tests digital and analog circuits in the central office or outside plant. Compatible with DSX-1 and Analog test sets and supplies the necessary cords to test RJ45, RJ48, 66 block, 310 and single or dual bantam jacks.

KIT CONTAINS	PART NUMBERS
2-BAN-BAN Red 8ft	TC-200RX
2-BAN-BAN Blue 8ft	TC-200TX
2-BAN-310 Red 8ft	TC-230RX
2-BAN-310 Blue 8ft	TC-230TX
1-BAN-ALG Clips Red 8ft	TC-260RX
1-BAN-ALG Clips Blue 8ft	TC-260TX
1-310 Red TAD Adapter	TC-AD310R
1-310 Blue TAD Adapter	TC-AD310B
1-DBAN Looping Plug 3cond	TC-LP250
2-Ban Terminating Plugs 135ohm	TC-TP201
1-310-RJ11 8ft	TC-311
1-DBAN - RJ45 8ft	TC-259
2-66 Block Adapters	TC-AD66
1-Power Cord	TC-PC01/3
1-Screwdriver	TC-SD100
1-Flashlight	TC-FL100
1-Pliers Plus	TC-PL100
DS1 Kit	KT 290002



DSX1

2209 Tech Kit

This kit allows technicians to configure multiple combinations in one portable and easy to use kit. It will quickly and easily interface with both DS1 and DS3 applications.

KIT CONTAINS

PART NUMBERS

2-Tel-Line Testers	TC-TLTS 1A
1-310 TAD RED Adapter	TC-AD310R
1-310 TAD BLUE Adapter	TC-AD310B
1-RJ45-RJ45-Royblu-10ft	TC-140
1-BAN Terminating Plug 100ohm	TC-TP200
1-BAN-Y BAN, 463A, ALG CLIPS RED 16FT	TCC-232 RX
1-BAN-Y BAN, 463A, ALG CLIPS BLUE 16FT	TCC-232 TX
1-RJ45 Female-Y BAN Red & Blue 8ft	TC-16118
1-BNC Female Barrel Coupler	TC-BNCCPLR
1-440A-440A-BLUE-8ft	TC-440A/TX
1-440A-440A-RED-8ft	TC-440A/RX
1-RJ48C Shorting Tool	TC-LPRJ48C
1-RJ45-Y BAN-8ft	TC-TR248C
1-Power Cord 3ft	TC-PC01/3
2209 Tech Kit	KT 290035



High Capacity Provision Kit

Data cable kit specifically designed to meet the needs of turning up HICAP circuits. Multiple configurations of the 30 ft long RJ45 cable can be made using the included adapters.

KIT CONTAINS

PART NUMBERS

1-RJ45 Female-9 Male Adapter	TC-16382
1-15pin Male-RJ45 Female Adapter	TC-16409
1-RJ45 Female-25 Male L/P Adapter	TC-16391
1-Null Modem 25 Female-25 Male L/P Adapter	TC-NM100LP
1-Null Modem 9 Male-9 Female L/P Adapter	TC-NM900LP
1-9 Female-RJ45 Adapter Kit	TC-AD9FRJ45
1-RJ45-RJ45 30ft	TC-RJ48/30
1-RJ45 Coupler	TC-CPLR45
High Capacity Provision Kit	KT 290146



Digital Alarm Remote Response Team Kit

Full D1 and D0 test kit manufactured for DARRT teams. Includes all cables and adapters needed to test from any manufacturer's bantam or 310 based test equipment.

KIT CONTAINS

PART NUMBERS

2-RJ45 Coupler	TC-CPLR45
2-RJ45-RJ45 50ft	TC-RJ48/50
1-BAN-BAN Red 25ft	TC-200RX/25
1-9 Female-RJ45 10ft	TC-16385/10
1-BAN-BAN Blue 25ft	TC-200TX/25
1-310 Red TAD Adapter	TC-AD310R
1-310 Blue TAD Adapter	TC-AD310B
1-9 Female-RJ45 Adapter	TC-16400
1-15 Pin Female-Y 310-2FT	TC-15F310/2
1-25 Male-RJ45 Jack Adapter	TC-16394
1-RJ45 Female-25 Male FMT150 Adapter	TC-16388
1-310-Y BAN, 463A, ALG Clips, Blue 15ft	TCC-323 TX
1-310-Y BAN, 463A, ALG Clips, Red 15ft	TC-323 RX
1-310 Female-LHTCAB Red 10ft	TC-360FLTBX/10
1-310 Female-LHTCAB Blue 10ft	TC-360FLTBTX/10
1-RJ45 Female-9 Male Adapter	TC-16391
1-RJ45 Female-25 Male Adapter	TC-16382
1-RJ45-RJ45-25ft	TC-140/25
1-RJ45-RJ45 T1 Wired-25ft	TC-RJ48S/25
Digital Alarm Remote Response Team Kit	KT 290095



DSX3

Connect All Kit

This popular kit combines the most widely used components for both DS1 and DS3 testing, all in one convenient and affordable package!

KIT CONTAINS

PART NUMBERS

2-BAN-BAN-Red	TC-200RX
2-BAN-BAN-Blue	TC-200TX
1-BAN-Y LHTCAB-Red	TC-260LTB RX
1-BAN-Y LHTACB-Blue	TC-260LTB TX
1-RJ45-Y BAN	TC-TR248C
1-Tel-Line Tester	TC-TLTS 1A
2-310 Blue TAD Adapter	TC-AD310B
2-310 Red TAD Adapter	TC-AD310R
2-BNC-358 Adapter	TC-AD358
4-BNC-440 Adapter	TC-AD440
1-BNC-BNC-Red	TC-500RX
1-BNC-BNC-Blue	TC-500TX
4-BNC Coupler	TC-BNCCPLR
1-Power Cord	TC-PC01/3
1-Banjo	TC-BJ100
1-Flashlight	TC-FL100
1-Screwdriver	TC-SD100
1-Pliers Plus	TC-PL100
Connect All Kit	KT 290467



Universal DS3 Kit

Now you can stop carrying six test cords in a heap and have all test cord configurations at your fingertips! It's a snap with Westek's Universal DSX-3 Test Cord Kit. A durable nylon carrying case which contains both transmit and receive cords and all the plug ends needed.

KIT CONTAINS

PART NUMBERS

1-BNC-BNC Red 8ft	TC-500RX
1-BNC-BNC Blue 8ft	TC-500TX
4-BNC-440 Adapter	TC-AD440
4-BNC-358 Adapter	TC-AD358
Universal DS3 Kit	KT 290041



T-Berd 2209 Kit

This kit contains DS1 and DS3 test cables for all the T-Berd test set applications, all in one convenient and affordable kit bag!

KIT CONTAINS

PART NUMBERS

1-BAN-Y BAN, 463A, ALG CLIPS BLUE 16FT	TCC-232 TX
1-BAN-Y BAN, 463A, ALG CLIPS RED 16FT	TCC-232 RX
1-RJ45 Female-Y BAN Red & Blue 8ft	TC-16118
2-Ban Terminating Plug 100ohm	TC-TP200
1-BNC Female Barrel Coupler	TC-BNCCPLR
1-310 TAD BLUE Adapter	TC-AD310B
1-310 TAD RED Adapter	TC-AD310R
1-RJ45-RJ45-Royblu-10ft	TC-140
1-440A-440A-BLUE-8ft	TC-440A/TX
1-440A-440A-RED-8ft	TC-440A/RX
1-RJ48C Shorting Tool	TC-LPRJ48C
2-Tel-Line Testers	TC-TLTS 1A
1-RJ45-Y BAN-8ft	TC-TR248C
1-Power Cord 3ft	TC-PC01/3
1-Flashlight	FL100
1-Screwdriver	SD100
T-Berd 2209 Kit	KT 290038



FIBER KITS

Deluxe Fiber Cleaning Kit

This kit aides technicians in fiber preparation, cleaning and analyzing.

KIT CONTAINS

PART NUMBERS

1-Cleaning Cassette	FC 15433
50-2.5mm Cleaning Sticks.....	FC 15271
20-Pre-saturated Wipes	FM 21106
5-Cleaning Cards	FC 15566
1-Air Can.....	FM 21097
1-Replacement Tape.....	FC 15436
1-Bag.....	CB 17018
1-If Applicable, Fiber Microscope 400.....	FC 15567
1-If Applicable, Fiber Microscope 200.....	FC 15568

Deluxe Fiber Test Kit with fiber microscope 400.....KT FBRCLN400
Deluxe Fiber Test Kit with fiber microscope 200KT FBRCLN200
Deluxe Fiber Test Kit no microscope..... KT FBRCLN



Fiber Test Kit

This kit contains the most commonly used test cords for both DS3 and Fiber testing.

KIT CONTAINS

PART NUMBERS

1-SC-SC-SM-SX-10FT	FW 23008/10
1-FC-FC-SM-SX-10FT	FW 23002/10
1-ST-SC-SM-SX-10FT	FW 23029/10
1-SC Male-SC Female 5DB Attenuator	FC 3ATT5DB
1-SC Male-SC Female 10DB Attenuator	FC 3ATT10DB
1-SC Male-SC Female 20DB Attenuator	FC 3ATT20DB
1-BAN-BAN-BLUE-10FT	TC-200TX/10
1-BAN-BAN-RED-10FT	TC-200RX/10
1-BNC-BNC-BLUE-10FT	TC-500TX/10
1-BNC-BNC-RED-10FT	TC-500RX/10
1-440A-BNC-BLUE RG59-10FT	TC-540RGTX/10
1-440A-BNC-RED RG59-10FT	TC-540RGRX/10
1-Power Cord 3ft	TC-PC01/3
1-Wrist Strap	TC-WS100
1-Screwdriver	TC-SD100
1-Flashlight	TC-FL100
Fiber Test Kit	KT-290101



Fiber Cleaning Kit

This kit allows technicians to have all the necessary Fiber cleaning components in one organized kit bag.

KIT CONTAINS

PART NUMBERS

20-Optic Prep Pre-Saturated Wipes	FM 21106
1-Bifurcation Swipe	FM 21088
1-Canned Air	FM 21097
1-Box, w/Cleaner for Connector	FM 15277
20-Adapter Cleaners	FM 21091
1-Kimwipes Lint Free Case	FM 21100
Fiber Cleaning Kit	KT 290389



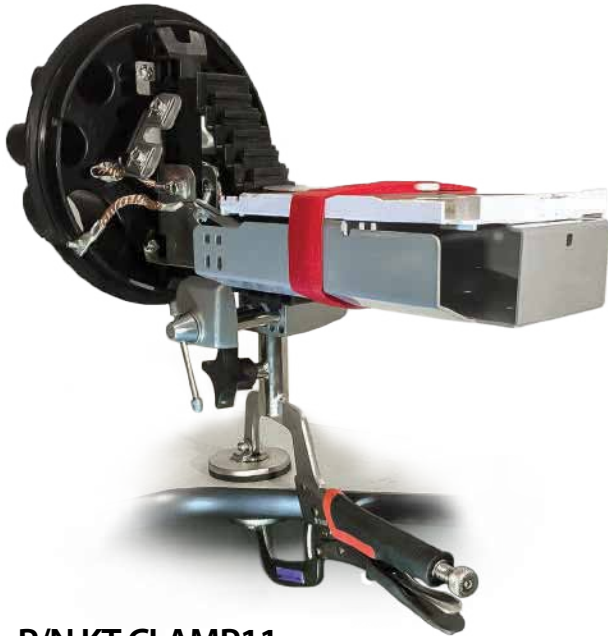
Westek Portable FOSC Workstations



1(800) 526-2673 www.westek.com

Westek Cable and Telecom Solutions

PATENT PENDING



P/N KT CLAMP11



P/N KT CL11TB2

WTK Part #	Mat Code	Short Description	Long Description	Picture
KT CLAMP11	TBD	11IN CLAMP, FOSC V2 W/TUBE ADAPTER AND VISE	11IN CLAMP, FOSC V2 W/TUBE ADAPTER and Vise. CREATES A STABLE WORK PLATFORM. WORKS WITH WESTEK FOSC FIXTURING BRACKETS, VISE, FIBER WORK TRAY, AND FOSC END PLATE FIXTURES. WESTEK TC-CLAMP11	
KT CLAMP18	TBD	18IN CLAMP, FOSC V2 W/TUBE ADAPTER AND VISE	18IN CLAMP, FOSC V2 W/TUBE ADAPTER AND Vise. CREATES A STABLE WORK PLATFORM. WORKS WITH WESTEK FOSC FIXTURING BRACKETS, VISE, FIBER WORK TRAY, AND FOSC END PLATE FIXTURES. WESTEK TC-CLAMP18	
KT CL11TB2	TBD	11IN CLAMP, FOSC V2 W/TUBE ADAPTER, VISE, EXT. BRACKET AND WORK TRAY	UNIVERSAL WORKSTATION. INCLUDES FIBER WORK TRAY 12X24 in, FOSC VISE, 11 IN CLAMP, EXTENSION BRACKET, AND MOUNTING POST. CREATES A STABLE WORK PLATFORM. WORKS WITH WESTEK FOSC FIXTURING BRACKETS, CLAMPS, AND ADAPTERS	

RFL TEST SET REPLACEMENT CORD KIT

KT BANANA KIT

18 AWG



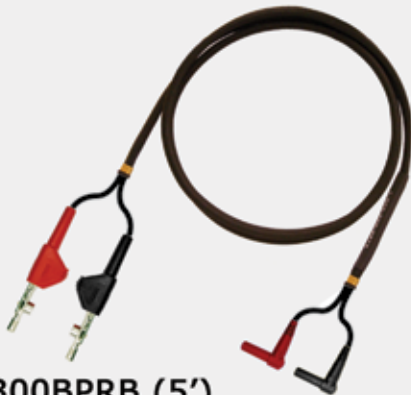
TC-3300BPGN (5')

R/A Banana Grn to LHTCABP Grn
.....Part # TC-300BPGN (5')



TC-3300BPYB (5')

2 R/A Bananas Yel/Blu to 2 LHTCABP Yel/Blu
.....Part # TC-3300BPYB (5')



TC-3300BPRB (5')

2 R/A Bananas Red/Black to 2 LHTCABP Red/Blk
.....Part # TC-3300BPRB

KT BANANA KIT Kit Includes:

- TC-3300BPGN (5')
- TC-3300BPYB (5')
- TC-3300BPRB (5')



INDIVIDUAL RFL TEST SET CORDS

24 AWG



TC-30004GN/6

Shrouded Mini Banana to Alligator Clip (Green)
.....Part # TC-3004GN/6



TC-30008RX/6

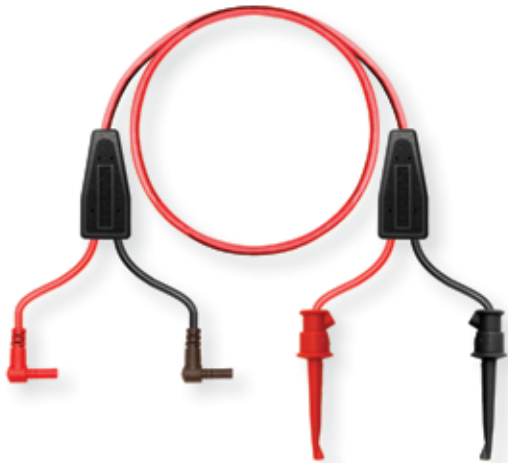
Shrouded Mini Banana to Alligator Clips (2)(Red/Blk) 6'
.....Part # TC-30008RX/6



TC-30008TX/6

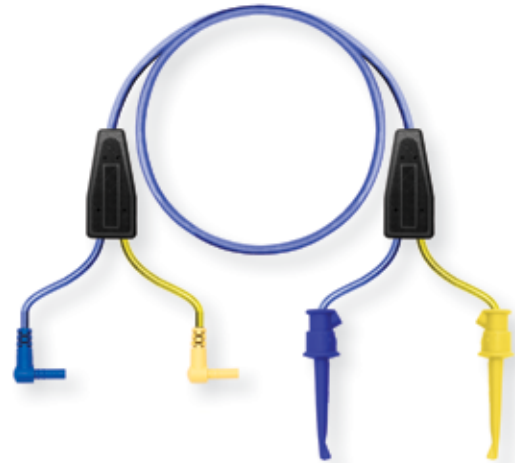
Shrouded Mini Banana to (2) Alligator Clips (Blu/Yellow)
.....Part # TC-3004GN/6

TEST-SET CORDS



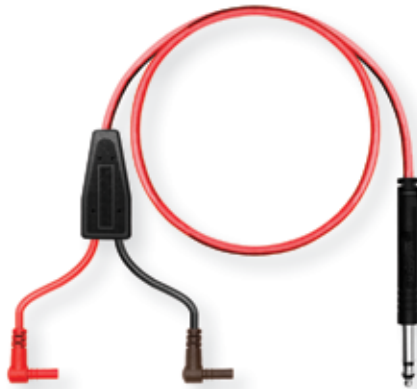
(2) R/A Shrouded Mini Banana to (2) Mini Grabbers Red (6ft)

Replacement cables for Dynatel 965AMS, HST-3000 and other testing units.....Part # TC-3001RX/6



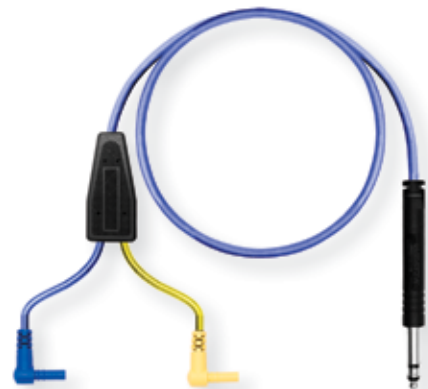
(2) R/A Shrouded Mini Banana to (2) Mini Grabbers Blue (6ft)

Replacement cables for Dynatel 965AMS, HST-3000 and other testing units.....Part # TC-3001TX/6



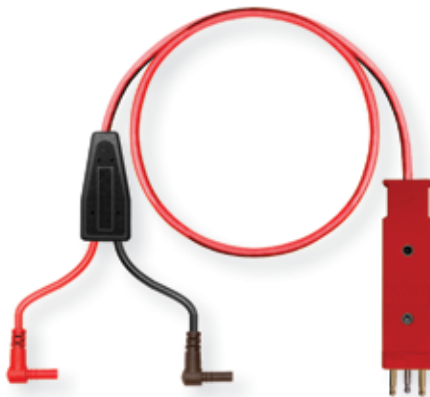
(2) R/A Shrouded Mini Banana to Bantam Red (6ft)

Replacement cables for Dynatel 965AMS, HST-3000 and other testing units.....Part # TC-3002RX/6



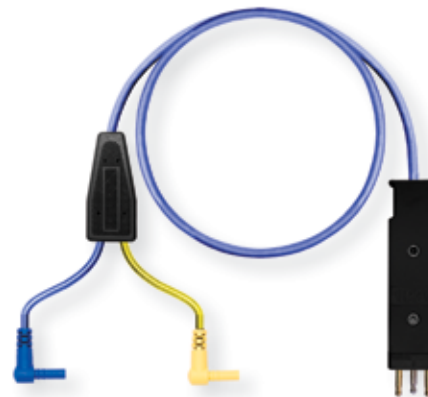
(2) R/A Shrouded Mini Banana to Bantam Blue (6ft)

Replacement cables for Dynatel 965AMS, HST-3000 and other testing units.....Part # TC-3002TX/6



(2) R/A Shrouded Mini Banana to 463A-In Red (6ft)

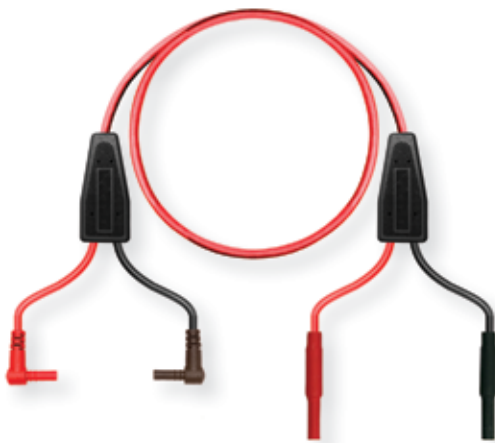
(2) R/A Shrouded Mini Banana-463A In Red 6ftPart # TC-3003RX/6



(2) R/A Shrouded Mini Banana to 463A-In Blue (6ft)

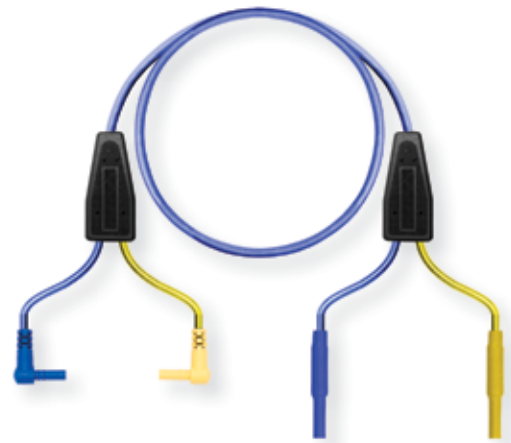
(2) R/A Shrouded Mini Banana-463A In Blue 6ftPart # TC-3003TX/6

TEST-SET CORDS



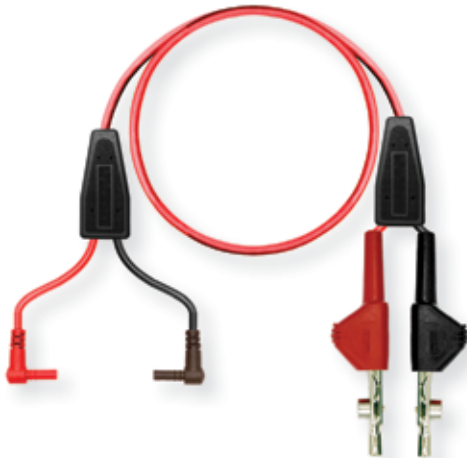
(2) R/A Shrouded Mini Banana to (2) Chuck Ends Red (6ft)

Replacement cables for Dynatel 965AMS, HST-3000 and other testing units.....Part # TC-3006RX/6



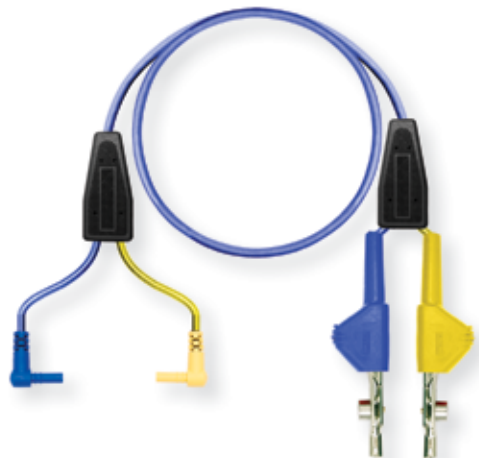
(2) R/A Shrouded Mini Banana to (2) Chuck Ends Blue (6ft)

Replacement cables for Dynatel 965AMS, HST-3000 and other testing units.....Part # TC-3006TX/6



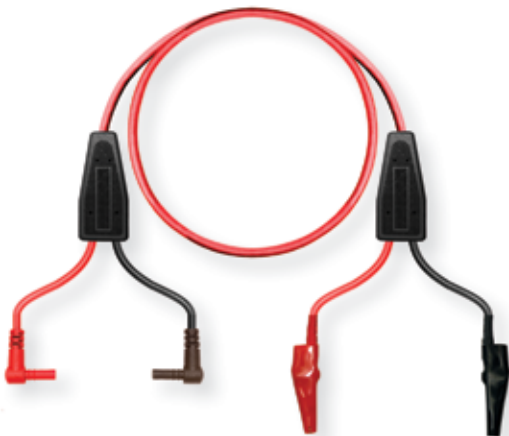
(2) R/A Shrouded Mini Banana to (2) LHTCABP Red (6ft)

Replacement cables for Dynatel 965AMS, HST-3000 and other testing units.....Part # TC-3007RX/6



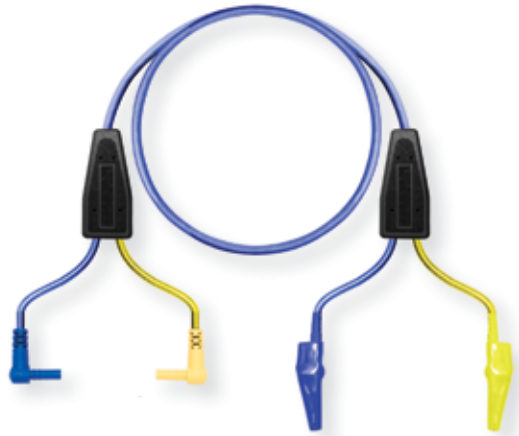
(2) R/A Shrouded Mini Banana to (2) LHTCABP Blue (6ft)

Replacement cables for Dynatel 965AMS, HST-3000 and other testing units.....Part # TC-3007TX/6



(2) R/A Shrouded Mini Banana to (2) Alligator Clips Red (6ft)

Replacement cables for Dynatel 965AMS, HST-3000 and other testing units.....Part # TC-3008RX/6



(2) R/A Shrouded Mini Banana to (2) Alligator Clips Blue (6ft)

Replacement cables for Dynatel 965AMS, HST-3000 and other testing units.....Part # TC-3008TX/6

TEST-SET CORDS

All Banana Plugs feature the patented locking suction design to keep dirt and moisture out and hold securely to the jack.



R/A Shrouded Mini Banana (4) to RJ45 Wired 1,2,7,8 (6ft)

Replacement cables for Dynatel 965AMS, HST-3000 and other testing units.....Part # TC-3009/6



R/A Shrouded Mini Banana (4) to RJ45 Wired 1,2,4,5 (6ft)

Replacement cables for Dynatel 965AMS, HST-3000 and other testing units.....Part # TC-3010/6



R/A Shrouded Mini Banana to Alligator Clip Green (6ft)

Replacement cables for Dynatel 965AMS, HST-3000 and other testing units.....Part # TC-3004GN



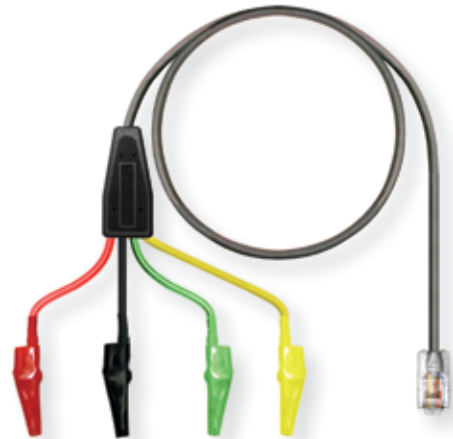
R/A Shrouded Mini Banana to #27 Clip Green (6ft)

Replacement cables for Dynatel 965AMS, HST-3000 and other testing units.....Part # TC-3005GN



R/A Shrouded Mini Banana to LHTCABP Green (3ft)

Replacement cables for Dynatel 965AMS, HST-3000 and other testing units.....Part # TC-3011GRN/3



RJ45 to Alligator Clips (4)

RJ48 modular plug to red/black/green/yellow alligator clips (4).....Part # TC-4PL1

COAX



Single BNC to Single BNC w/Tracer

Coax test, patch, and loop. With tracer pin.
Part # TC-500T



Dual BNC to Dual BNC w/Tracer

Coax test, patch, and loop. With tracer pin.
Part # TC-D500T



DBNC-D440D W/Tracers

Coax test, patch, and loop. With tracer pin.
Part # TC-D552T



DLCC-DLCC W/Tracers

Coax test, patch, and loop. With tracer pin.
Part # TC-DLCCCT



Dual 440D to Dual 440D w/Tracer

Coax test, patch, loop, or equipment prove in. With tracer pins and lock tabs.....Part # TC-D452T

COAX ADAPTERS



BNC to 358 Adapter

Coax Adapter.....Part # TC-AD358



BNC to 440 Adapter

Coax Adapter.....Part # TC-AD440

COAX



Bantam to BNC

Conversion test and patch.....Part # TC-220



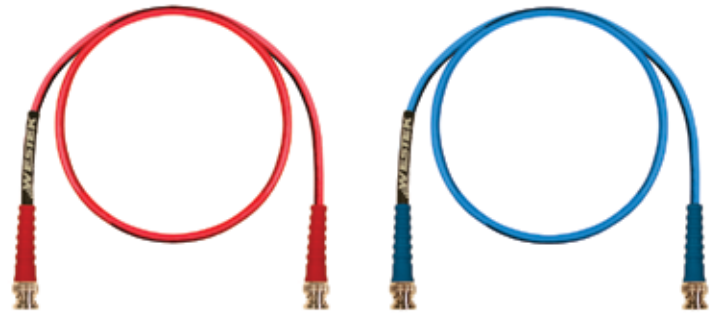
440A to 440A

Test equipment to 440A coax panel. Also available in 440D with locking tabs.....Part # TC-440A



BNC to BNC

DSX-3 patch or adapter cord.....Part # TC-500



BNC to BNC RECEIVE/TRANSMIT

DSX-3 patch or adapter cord. RG59 cable receive Red.....Part # TC-500RX

DSX-3 patch or adapter cord. RG59 cable transmit Blue.....Part # TC-500TX



440 to LCP

440 to LCP, 735a cable
.....Part # TC-445



BNC to 440A

DSX-3 patch or adapter cord.....Part # TC-540

DATA



15pin Female to Y 310

310 Y (TX and RX) to 15 pin (Female) connector.
.....Part # TC-15F310



15pin Female to Y Bantam

Ban Y (TX and RX) to 15 pin (Female) connector.....Part # TC-15F200



15pin Male to Y Bantam

Ban Y (TX and RX) to 15 pin (Male) connector.
.....Part # TC-15M200



15pin Male to Y 310

310 Y (TX and RX) to 15 pin (Male) connector.
.....Part # TC-15M310



25pin Male to 9pin Female

Standard laptop cable. 25 pin Male to 9 pin Female.....Part # TC-25M9F



9pin Male to 9pin Female

Standard laptop cable. 9 pin Male to 9 pin Female. Wired straight through. Also available in cross wire.....Part # TC-9M9F/10

DATA



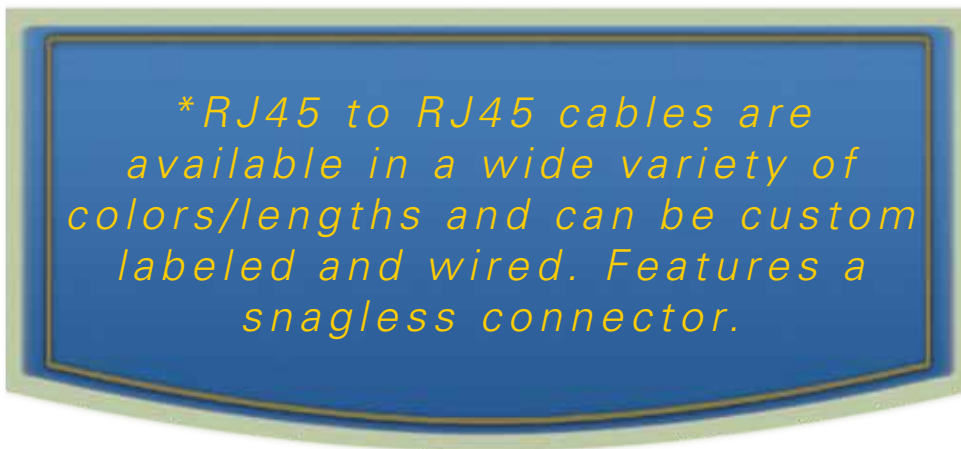
RJ45 to RJ45 Blue

General purpose patch and test cord.
.....Part # TC-140



9pin (Male) to RJ48 T1

9 pin D to RJ48 modular T1 plug. Also available with female 9 pin.....Part # TC-9MRJ45



9 Female Gender Changer

Gender Changer, 9(F)-9(F) Slim.
.....Part # TC-GCPC9F



9 Male Gender Changer

Gender Changer, 9(M)-9(M) Slim.
.....Part # TC-GC9M



25 Female Gender Changer

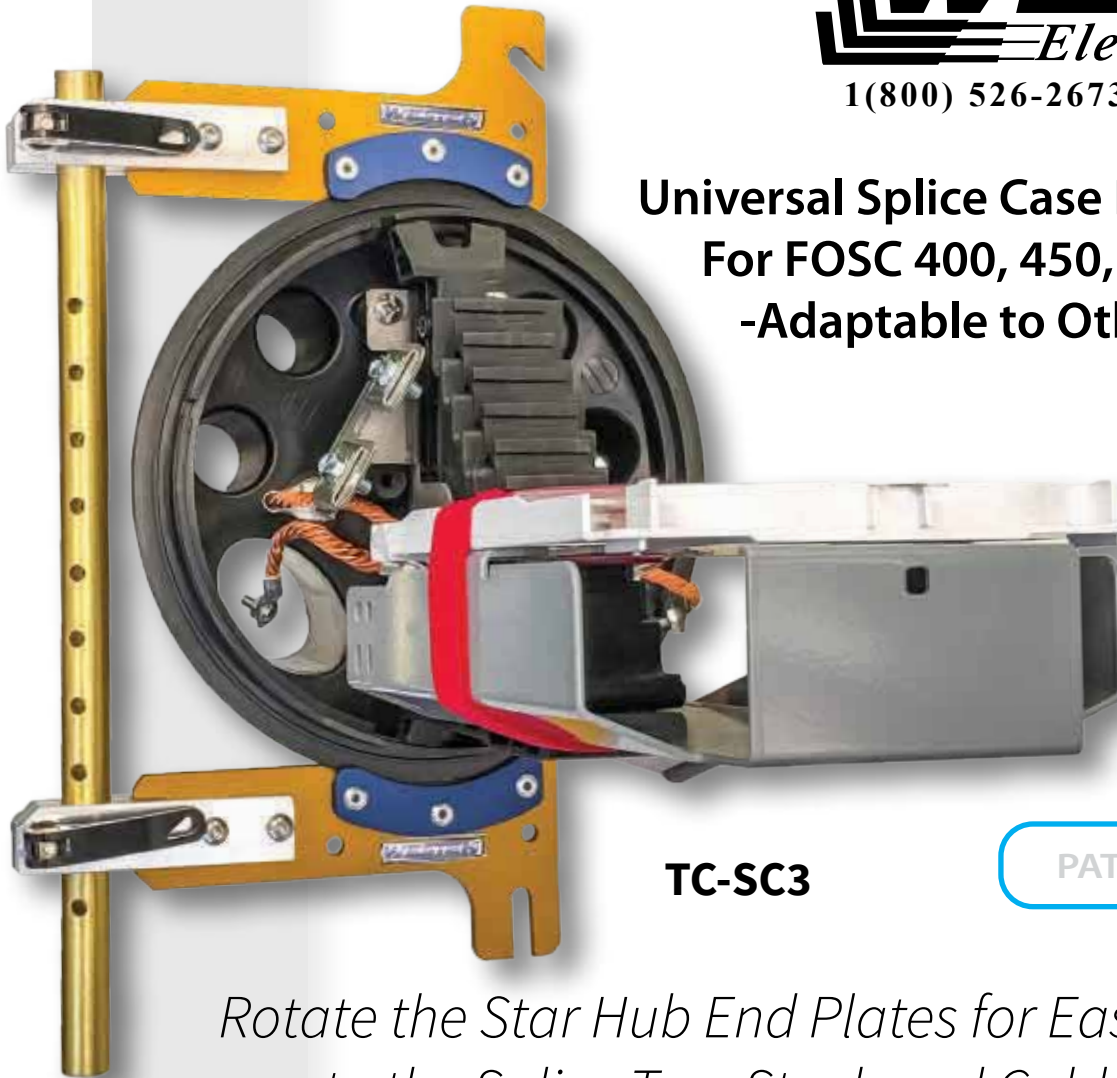
Gender Changer, 25(F)-25(F) Slim.
.....Part # TC-GCPC25F



25 Male Gender Changer

Gender Changer, 25(M)-25(M) Slim.
.....Part # TC-GCPC25M

Universal Splice Case Bracket System For FOSC 400, 450, and Coyote -Adaptable to Other Cases-



TC-SC3

PATENT PENDING

*Rotate the Star Hub End Plates for Easier Access
to the Splice Tray Stack and Cable Ports*



Universal



400

Clamp Mount



Table Mount

COPPER



RJ45 to Y Bantam DS1 RJ48C Wired

Bantam "Y" (Transmit and Receive) to RJ45 modular plug. (Transmit and Receive) from network interface unit DS1/T1. Wired 1,2,4,5.....Part # TC-TR248C



RJ45 to Y Bantam DSO RJ48S Wired

Bantam "Y" (Transmit and Receive) to RJ45 modular plug. (Transmit and Receive) from network interface unit DSO. Wired 1,2,7,8.....Part # TC-TR248S



RJ45 to Y 310 DS1 RJ48C Wired

310 "Y" (Transmit and Receive) to RJ45 modular plug. (Transmit and Receive) from network interface unit DS1/T1. Wired 1,2,4,5.....Part # TC-TR348C



RJ48 to Y 310 DSO RJ48S Wired

310 "Y" (Transmit and Receive) to RJ45 modular plug. (Transmit and Receive) from network interface unit DSO. Wired 1,2,7,8.....Part # TC-TR348S



Bantam to 310

3 Conductor bantam plug to 3 conductor 310 plug. Bantam DSX bay to 310, or test equipment patch cord.Part # TC-230



Bantam to 463A

3 Conductor single bantam plug to 463A (4B) type interface. Standard looking out. Also available in looking in.....Part # TC-5P200

COPPER



Bantam to Alligator Clips

3 Conductor single bantam plug to alligator clips (2).
Test equipment access on 66 block.....Part # TC-260



Bantam to Bantam

3 Conductor single bantam plug on both ends.
Bantam DSX bay or test equipment..Part # TC-200



Bantam to BNC

Conversion test and patch.....Part # TC-220



Bantam to Female 310

3 Conductor male bantam plug to 3 conductor female 310 receptacle. Extension cord (1 ft), test equipment patch cord.Part # TC-203S



Bantam to Mini Grabbers

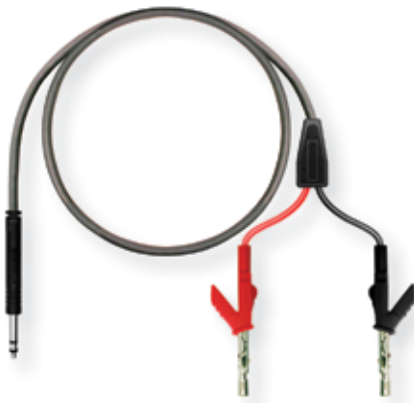
3 Conductor Bantam to Mini-Grabber clips (2). Test equipment to the various access points, bare cablesPart # TC-240



Bantam to RJ45

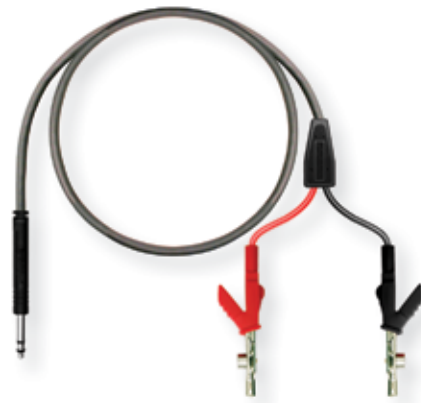
3 Conductor single bantam to RJ45 modular 8 position 2-wire 3, 4.....Part # TC-248

COPPER



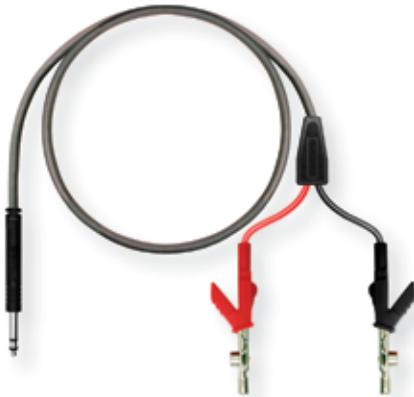
Bantam to Y Heavy Test Clip

3 Conductor single bantam plug to heavy test clips. Test equipment access on 66 block. Single pin.Part # TC-260LTP



Bantam to Y Heavy Test Clip

3 Conductor single bantam plug to heavy test clips. Test equipment access on 66 block. Bed of Nails.....Part # TC-260LTB



Bantam to Y Heavy Test Clip

3 Conductor single bantam plug to heavy test clips. Test equipment access on 66 block. Bed of Nails and Single Pin.....Part # TC-260LTBP



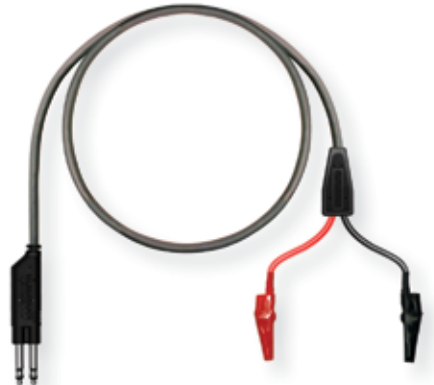
Bantam to Y Wire Wrap

3 Conductor single bantam plug to wire wrap terminals (Female). Test equipment to access terminal block pins.Part # TC-272



Dual Bantam to 463A

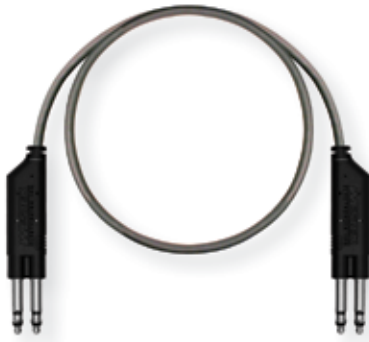
3 Conductor dual bantam plug to 463A (4B) type interface. T1 repeater powering unit, test equipment access at coil. (Tip to long pins, Ring to short pins).Part # TC-5P250



Dual Bantam to Alligator Clips

3 Conductor dual bantam plug to 2 red/black alligator clips. Special test applications. Tips only.Part # TC-256

COPPER



Dual Bantam to Dual Bantam

3 Conductor dual bantam plug on both ends. Dual bantam DSX bay to patch circuits....Part # TC-250



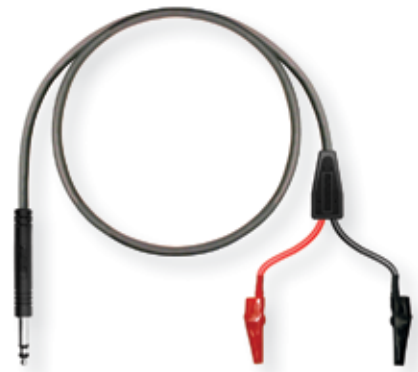
310 TO 310

3 Conductor single 310 on both ends.....Part # TC-310



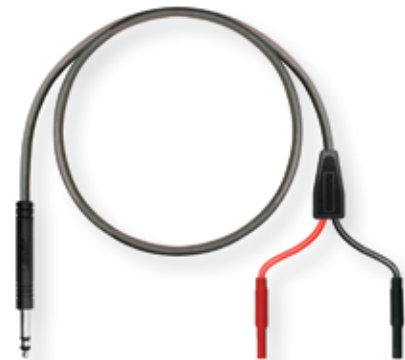
310 to 463A

3 Conductor single 310 plug to 463A (4B) type protector, interface. Standard looking out. Also available in looking in.....Part # TC-5P310



310 to Alligator Clips

3 Conductor single 310 to mini-grabber clips (2). Test equipment to various access points, bare cables.Part # TC-360



310 to Wire Wraps

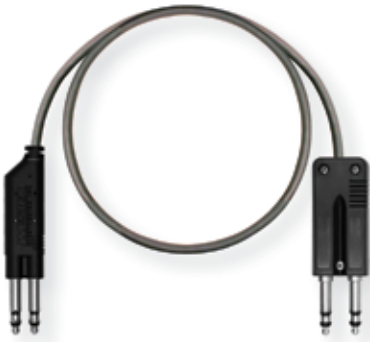
3 Conductor single 310 to wire wrap terminals (female). Test equipment to access terminal block pins.....Part # TC-372



Dual 310 to Dual 310

3 Conductor dual 310 to plugs on both ends. Dual 310 DSX bay patch circuits.....Part # TC-350

COPPER



Dual 310 to Dual Bantam

3 Conductor dual 310 plug to dual bantam. Dual 310 DSX bay patch circuits.....Part # TC-290



RJ45 to 310

3 Conductor single 310 plug to modular RJ45 8 position, 2 wire, pins 4, 5.....Part # TC-348



453A to Alligator Clips

Used to short or to ground the tip and/or ring plugs to recessed terminals on 300 series connectors (except 310) Equivalent to P2EF Standard 1'4"Part # TC-P2EF



463A to Alligator Clips

463A (4B) type protector to alligator clips. Access at coils.....Part # TC-5P600



526A to Alligator Clips

Used to piggyback test points on protector to monitor without pulling protector (coil). Standard 1'4"Part # TC-P2FL



L5 to Alligator Clips

Used to short the tip and ring or to ground the tip and/or ring plugs to recessed terminals on 310 series connectors. Equivalent to P2FM. Standard length 1'4".....Part # TC-P2FM

COPPER



L8 Porta to Alligator Clips

Porta (replaces Protector) Test equipment access. Tested in the field, short for loop back testing Red to look out to field.....Part # TC-L8600



L8 Porta to Bantam

Porta (replaces Protector) to 3 conductor single bantam. Test equipment porta to bantam access. Standard looking out also available in looking inPart # TC-L8200



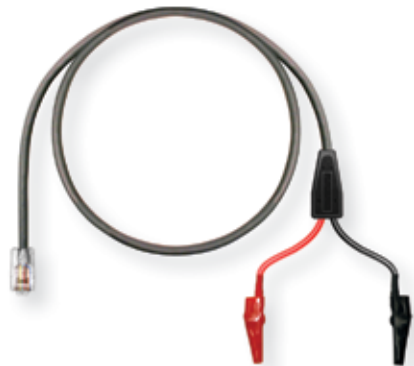
LX Porta to Alligator Clips

Porta LX access. Plugs into test field. Test equipment access.....Part # TC-P2LX



299 to Alligator Clips

Plugs into test field. Test equipment accessPart # TC-P299EF



RJ45 to Alligator Clips

RJ45 modular plug to red/black alligator clips (2). Special test applications. Pins 4, 5Part # TC-2PL1



SLC-5 to Alligator Clips

Plugs into faceplate jacks to provide access to the tip (T) and ring of both the odd and even channels. Designed for fields and Central Office use. Standard length 1'4".....Part # TC-SLC5



SLC-96 to Alligator Clips

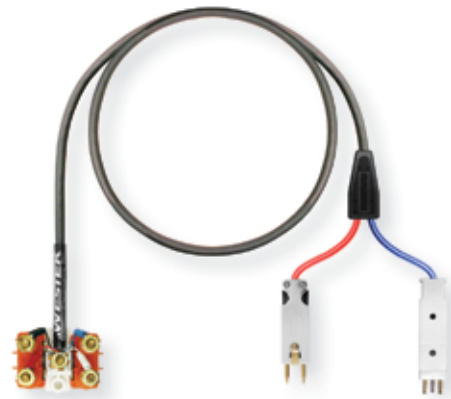
Provides quick and easy access to odd and even test points of all central office and field SLC-96 subscriber channel cords. Guarantees accurate test results. Insures against improper test procedures that may lead to equipment damage and unnecessary maintenance. Standard length 1'4".....Part # TC-SLC96

COPPER



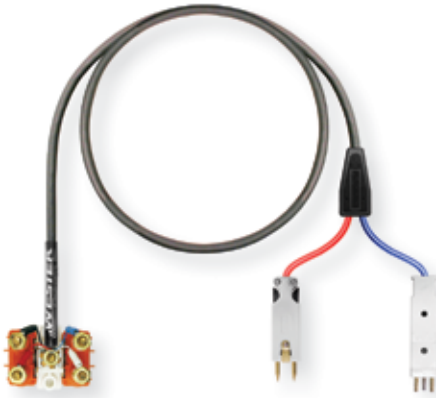
463A to Castle

16ft 4 Conductor slate cord with a 463A plug on one end and a 125EBW-2 protector on the other end. Used in SLC applications outside plant.
Part # TC-W4DG



Castle to 463A and 526A

16ft 4 Conductor slate cord with a 463A plug and 526A plug on one end and a 125EBW-2 protector on the other end. Used in SLC applications outside plant.
Part # TC-6W3E



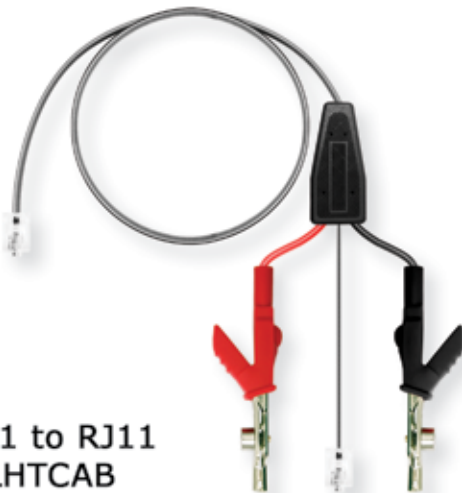
Castle to 463A and 526A Special Wiring

16ft 4 Conductor slate cord with a 463A plug and 526A plug on one end and a 125EBW-2 protector on the other end. Used in SLC applications outside plant.
Part # TC-6W3DS



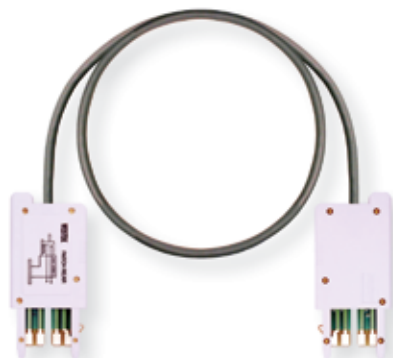
Molded RJ45 to Heavy Test Clips and Molded RJ11

Save valuable seconds and get accurate results fast! Wetek's XL 6000 test cord plugs directly into OPS, ISDN, and Central Office test sets. With the XL 6000, technicians can easily access cable pairs through modular wall jacks, panel jacks, or linesmen clips.Part # TC-6003



RJ11 to RJ11 to LHTCAB

Wetek's XL 6000 test cord plugs directly into OPS, ISDN, and Central Office test sets. With the XL 6000, technicians can easily access cable pairs through modular wall jacks, panel jacks, or linesmen clips.
Part # TC-6000



800 Duplex to 800 Duplex

3 Conductor 800 duplex plug on both ends. Patch in/out jacks at 800 DSX.
Part # TC-850

COPPER



800 Plug to 800 Plug Simplex

3 Conductor 800 simplex plug on both ends.
Part # TC-800



Bantam to 800 Plug

3 Conductor single bantam plug to 3 conductor 800 simplex DSX plug. Test equipment (bantam) to 800 DSX access.....Part # TC-820



800 Duplex to Y-Bantam

800 Duplex plug to 3 conductor Y-Bantam plugs
 Far Connect, Near Disconnect
Part # TC-823B



800 Duplex to Y-Bantam

800 Duplex Orange to 9 Y-Bantam 12"
 Cord Monitors
Part # TC-8230



800 Duplex White to Y Bantam

800 Duplex White to Y-Bantam 12" Cord
 Near Connect, Far Disconnect
Part # TC-823W



*800 Duplex to Y-310 Available

800 Duplex Blue to Y-310.....Part # TC-833B
 800 Duplex Orange to Y-310.....Part # TC-833O
 800 Duplex White to Y-310.....Part # TC-833W

***800 Looping Plugs on page 54**

FIBER - JUMPERS / PATCH



LC-LC-MM-SX

Link between bulkhead adapters, links terminal equipment, and links from terminal equipment to bulkhead adapters. Available in Single Mode or Multimode. Simplex or multi ended with a variety of connectors.....Part # FC 77201



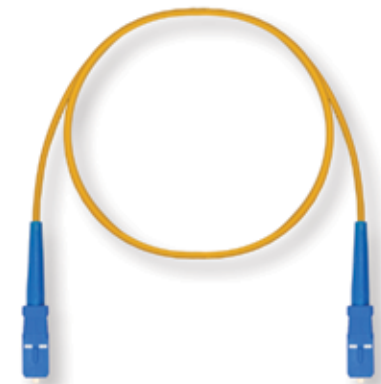
LC-LC-SM-SX

Link between bulkhead adapters, links terminal equipment, and links from terminal equipment to bulkhead adapters. Available in Single Mode or Multimode. Simplex or multi ended with a variety of connectors.....Part # FW 23236



BICONIC-BICONIC-SM-SX

Link between bulkhead adapters, links terminal equipment, and links from terminal equipment to bulkhead adapters. Available in Single Mode or Multimode. Simplex or multi ended with a variety of connectors.....Part # FC 5101



SC-SC-SM-SX

Link between bulkhead adapters, links terminal equipment, and links from terminal equipment to bulkhead adapters. Available in Single Mode or Multimode. Simplex or multi ended with a variety of connectors.....Part # FC 33031



FC-FC-SM-SX

Link between bulkhead adapters, links terminal equipment, and links from terminal equipment to bulkhead adapters. Available in Single Mode or Multimode. Simplex or multi ended with a variety of connectors.....Part # FC 11101



ST-ST-SM-SX

Link between bulkhead adapters, links terminal equipment, and links from terminal equipment to bulkhead adapters. Available in Single Mode or Multimode. Simplex or multi ended with a variety of connectors.....Part # FC 22101

FIBER - JUMPERS / PATCH



SC-SC-SM-DX

Link between bulkhead adapters, links terminal equipment, and links from terminal equipment to bulkhead adapters. Available in Single Mode or Multimode. Dual or multi ended with a variety of connectors.....Part # FW 23023



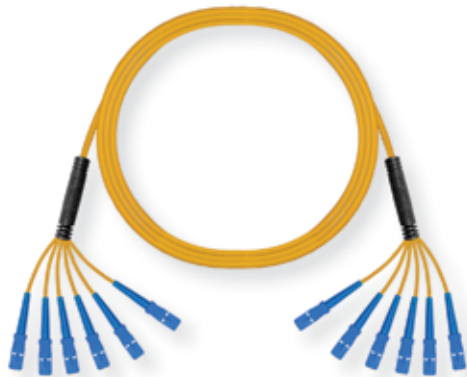
SC-SC-SM Quad

Link between bulkhead adapters, links terminal equipment, and links from terminal equipment to bulkhead adapters. Available in Single Mode or Multimode. Simplex or multi ended with a variety of connectors.....Part # FW 23086



SC-SC-SM 24fbr

Link between bulkhead adapters, links terminal equipment, and links from terminal equipment to bulkhead adapters. Available in Single Mode or Multimode. Simplex or multi ended with a variety of connectors.....Part # FW 23107



SC-SC-SM 12fbr

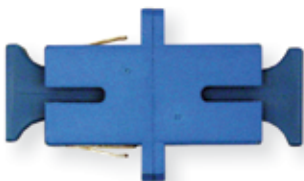
Link between bulkhead adapters, links terminal equipment, and links from terminal equipment to bulkhead adapters. Available in Single Mode or Multimode. Simplex or multi ended with a variety of connectors.....Part # FW 23110



SC-SC-SM 48fbr

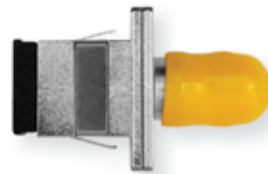
Link between bulkhead adapters, links terminal equipment, and links from terminal equipment to bulkhead adapters. Available in Single Mode or Multimode. Simplex or multi ended with a variety of connectors.....Part # FW 23194

FIBER - ADAPTERS



SC to SC Fiber Adapter

Ad, Fiber, SC-SC.....Part # FC-15316



SC to ST Fiber Adapter

Ad, Fiber, ST-SC.....Part # FC-15313



FC to FC Fiber Adapter

Ad, Fiber, FC-FC.....Part # FC-15319

FIBER - ATTENUATORS



ST(M) - ST(F) ATNR

- Part # FC 22ATT5dB
- Part # FC 22ATT10dB
- Part # FC 22ATT15dB
- Part # FC 22ATT20dB
- Part # FC 22ATT25dB



FC(M) - FC(F) ATNR

- Part # FC 1ATT5dB
- Part # FC 1ATT10dB
- Part # FC 1ATT15dB
- Part # FC 1ATT20dB
- Part # FC 1ATT25dB



LC(M) - LC(F) ATNR

- Part # FC 4ATT5dB
- Part # FC 4ATT10dB
- Part # FC 4ATT15dB
- Part # FC 4ATT20dB
- Part # FC 4ATT25dB



SC(M) - SC(F) ATNR

- Part # FC 3ATT5dB
- Part # FC 3ATT10dB
- Part # FC 3ATT15dB
- Part # FC 3ATT20dB
- Part # FC 3ATT25dB

FEATURE HIGHLIGHTS

- Wavelength Insensitive
- Modal Noise Suppression
- Low Polarization Dependent Loss
- High Laser Power Endurance
- Compact Design Fits Typical Connection
- Available in SC, FC, ST, LC

APPLICATIONS

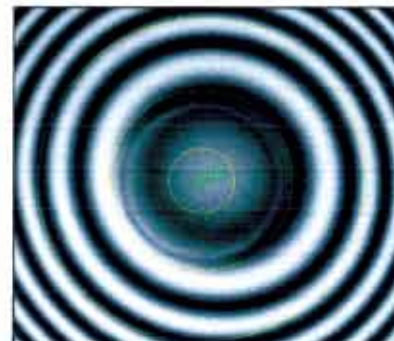
- Telecommunication Systems
- Cable Television Networks
- Test Equipment

SPECIFICATIONS

Parameter	Condition	Value
• Attenuation(dB)	1~30dB	1dB Incremental
• Operating wavelength(nm)	-	1310nm / 1550nm
• Return loss(dB)	PC	-50
	APC	-60
• Tolerance on attenuation(dB)	1 ~ 10dB	+/- 0.5
	11 ~ 30dB	+/- 1.0
• Polarization dependent loss(dB)	-	< 0.5
• Connecting Type	SC, FC, LC, ST	-
• Operating temperature	-40 ~ +75 c	-

Sample ID: 9	PASS		
Sample Name & Type: LC-LC 3M SX 2M PC Default	Westek Optical Research Company		
Measurement Time & Date: 12:55:59 PM 05/12/02	20-1 Gene Interferometer		
Fitting Regions Used: D=250um, E=140um, F=50um, A=1000um	XPL No:		
Measurement Parameter	Pass/Fail Limits Minimum Maximum	Measured Value	Passed or Failed
Radius of Curvature	7.00 25.00	10.14 um	Pass
Fiber Height (Spherical Fit)	100.0 100.0	-75.8 um	Pass
Fiber Height (Planar Fit)	-10.0 200.0	103.1 um	Pass
Apex Offset	0.00 50.00	11.28 um	Pass
	-0.200 0.200	0.064 deg	
		deg	
		deg	
Fiber Roughness (Rq)	0 50	4 um	Pass
Fiber Roughness (Ra)	0 50	3 um	Pass
Ferrule Roughness (Rq)	0 50	15 um	Pass
Ferrule Roughness (Ra)	0 50	13 um	Pass
Diameter	123.0 135.0	125.5 um	Pass
Comments			

Quality Control Report
(available upon request)



Insertion Loss	0.330 dB	-0.07 dB
Backreflection	1330 nm	-59 dB
	1550 nm	-59 dB
Sample ID:	9	
	12:55:59 PM	5/12/02
	PASS	

HOW TO ORDER COMBI-CORDS

*Sample Combi-Cord (C3) Shown Below



Combi-Cord Benefits

- Ultra-durable nylon braided jacket guarantees ruggedness and flexibility.
- Junction is constructed using insulated piercing lugs secured by a lock nut with a solder weld.
- Highest quality components made of state of the art materials insure long life and dependability.
- Red/Black nylon braided jacket protects insulated tinsel conductor.
- Combi Clip keeps plugs that are not in use up and out of the way.



Steps to ordering Combi-Cords

1

Choose Buttsheet End Connection

2

Choose Component Ends
(Up to Five Total)

COMBI-CORD COMPONENTS

1

Choose Buttset End Connection

B1....Hardware (w/Strain Relief)



B3....Hardwire (Round Lugs)



B4....Modular Type, 4 Conductor, RJ22



B6....Modular Type, 6 Conductor, RJ11



B8....Modular Type, 8 Conductor, RJ45 / RJ48



TS22...For Fluke/Harris test sets



TS44/TS52... For Fluke/Harris test sets



B2.... Quick Disconnect Option (471A QD or WECO Type 471A QD)



2

Choose Components (Up to Five Total)

LMG....Mini Grabbers (one pair: red /black)



LNAN....Banana Plug 4mm



LOE....Northern Telecom Original Equipment



LSLC5....SLC-5 Plug



Continued...

COMBI-CORD COMPONENTS



Choose Components (Up to Five Total)

L1....Alligator Clips (Mueller #60)



L110....AT&T 110 Connector Plug



L110D....110 D Test Connector



L2....453A or P2EF equivalent (AT&T 303 & 309-NT 377)



L284....Amphenol 284-1 Plug for 66 Block



L299...Plugs into NT 399 Block



L3....526A (Plugs into 4C Type Protector)



310...310 Plug



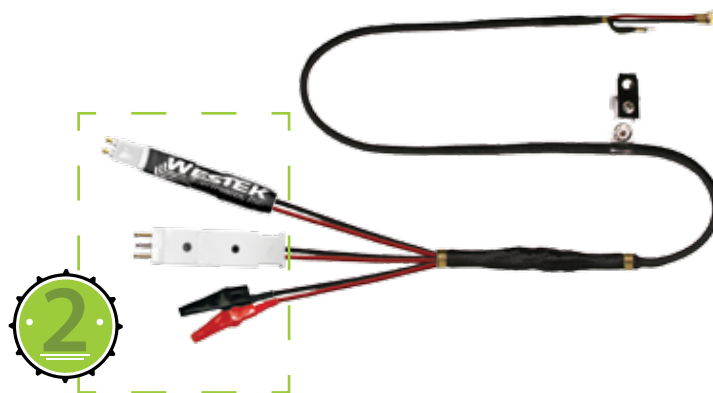
L3M...3M Binding Post Clip



L4....463A (Replaces 5 Pin Protector, wired to long pins)



Continued...

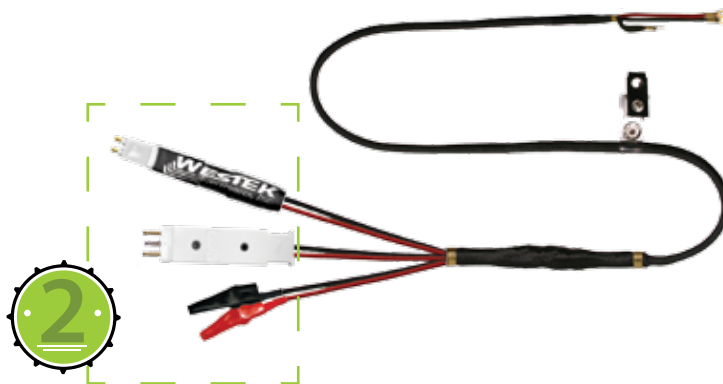


COMBI-CORD COMPONENTS










Choose Components (Up to Five Total)	
L4WO....L4 (without ground pin, wired to long pins, looks in and out)	
L5....P2FM Equivalent (AT&T 310 and 311)	
L6....Large Chuck ends (adapter 360 Tool) ; (one pair: red /black)	
L7.... Chuck Ends (over wire wrap pins) ; (one pair: red /black)	
L8....Porta (replaces protector)	
L9....Porta (plugs into protector)	
L96....SLC-96 Plug (equivalent to mini-plug)	
LDBAN....Dual Bantam Plug	
LHTCAB...Heavy Test Clips, Angle Nose, Bed of nails ; (one pair: red /black)	
LHTCAP....Heavy Test Clip, Angle Nose, Single Pin ; (one pair: red /black)	

Continued...



COMBI-CORD COMPONENTS



Choose Components (Up to Five Total)	
LMOD4Modular type plug, 4 conductor, RJ22	
LMOD6Modular Type Plug, 6 conductor, RJ11	
LMOD8Modular Type, 8 Conductor, RJ45 / RJ48	
LOMiniature alligator clips (Mueller #30) ; (one pair: red /black)	
LSStep switch space lug	
LXPorta (Plugs into test field)	
LBIXBix connector (QTBIX17-NT)	



** To convert buttset to quick disconnect see page 56*

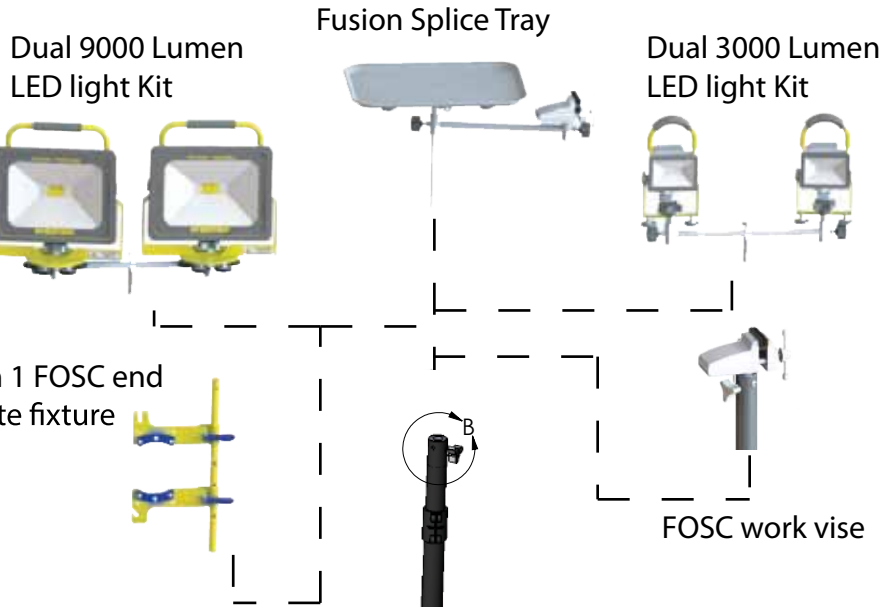
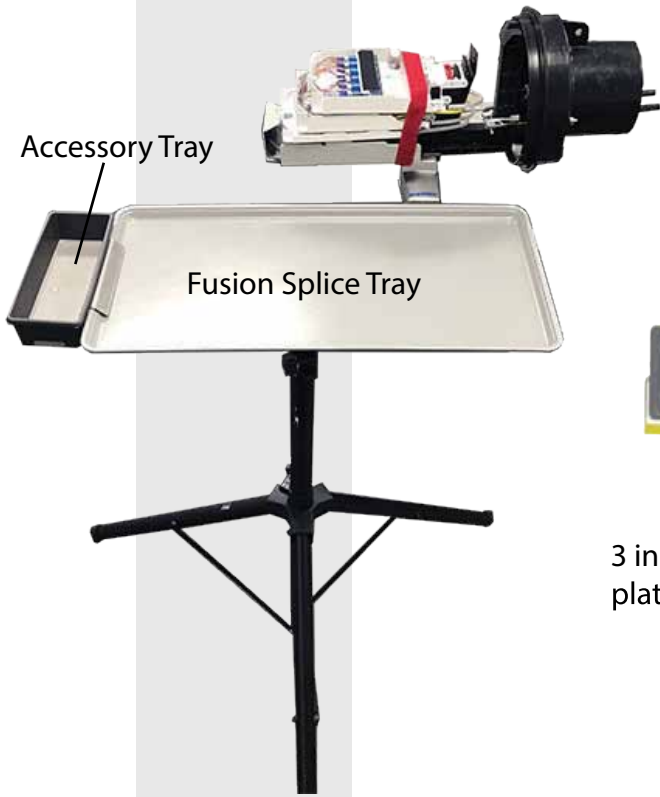
Westek Exclusive Patent Pending Adaptable Fiber Workstation



1(800) 526-2673 www.westek.com

Westek Cable and Telecom Solutions

PATENT PENDING

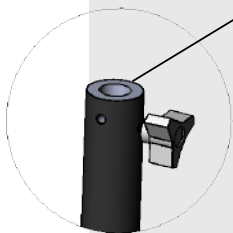


Features:

- Min height 40 in
- Max Height 71.0 in
- Load capacity: up to 132 lbs
- Retractable stabilizer Spike
- Portable and Light weight

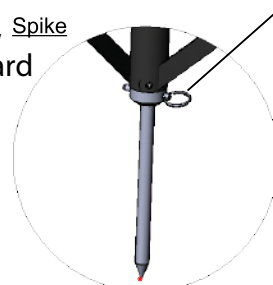


Table Adapter



DETAIL B

Standard 3/4in Receiver accepts Westek Fiber trays, Spike FOSC adapters, and standard telco accessories.



DETAIL A

Stabilizing spike penetrates soil and gravel to reduce tripod movement when used as a work platform. Remove pin and flip spike 180deg to store.

FILTERS / PLUGS / JACKS

Bantam Terminating Plug with Res 10

100 ohm, 3 conductor bantam terminating plug.....Part # TC-TP200



Bantam Terminating Plug with Res 60

600 ohm, 3 conductor bantam terminating plug.....Part # TC-TP206



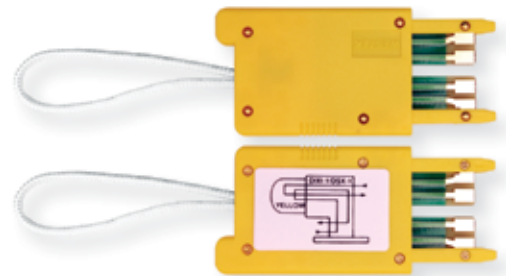
Dual Bantam Looping Plug

3 conductor dual bantam looping plug.....Part # TC-LP250



800 Duplex Looping Plug

Loops in both directions.....Part # TC-LP800



Bantam to 310 Adapter Blue

3 Conductor adapter. Converts bantam to 310. Nickel Plated Blue.....Part # TC-AD310B



Bantam to 310 Adapter Red

3 Conductor adapter. Converts bantam to 310. Nickel Plated Red.....Part # TC-AD310R



P2EF Shorting Tool

Used to short or ground the tip and or ring plugs to recessed terminals on 300 series connectors (except 310) Equivalent to P2EF standard 1' 4".....Part # TC-P2EFST



P2FM Shorting Tool

Looped plug-in (P2FM equivalent) used in recess test terminal for shorting purposes. (For AT&T 310)Part # TC-P2FMST



Porta Shorting Tool

Looped plug-in used in recess test terminal for shorting purposes (for 503, 505, 556P, porta connector blocks).Part # TC-P2LXST

ISDN FILTERS

440A ISDN Filter

The 440A ISDN Terminating Resistor Filter Adapter provides the standard 100 ohm circuit termination used on Integrated Services Digital Network (ISDN) Basic Rate Interface (BRI) circuits. The circuit consists of a 100 ohm resistor and DC-blocking capacitor in series across the first (4,5) and third (3,6) circuit pairs. The 440A Filter has an 8 position modular plug at one end and an 8 position modular jack at the other end. The modular plug is attached to short length of cord for easier installation. The adapter is typically installed between the information outlet and the ISDN terminal and can be used for both point-to-point and passive bus wiring arrangements.....Part # TC-ISDN



RF FILTERS

Z100 Filter

Low pass RF Filter, blocks frequencies from 5KHz - 200MHz.....Part # TC-Z100B1

HEADSET ADAPTERS

Piggyback Adapter 8 Position

PA 054345 000 400B2 piggyback adapter contains one 8 position 6 conductor plug; one 8 position 8 conductor jack; and one 6 position 2 conductor jack. It is used to provide auxiliary power to telephones.....Part # TC-400B2



Piggyback Adapter 6 Position

PA 05437 000 267F2 piggyback adapter contains one 6 position 4-conductor modular plug and one 6 position 2-conductor jack and one 6 position 4-conductor jack. These adapters are used to connect two telephones to a single modular jack and for connecting ancillary equipment.....Part # TC-267F2



Headset to Headset Plug

TC-W425 (replaces W.E. 425A) 3 conductor (tip, ring, sleeve) electrically independent self-aligning plugs, on .625 inch (15.875mm) centers. Mates with all standard 3 conductor jacks. Shell notched for polarity. Standard shell color black.Part # TC-W425N



W425 Plug End

TC-W425 (replaces W.E. 425A) 3 conductor (tip, ring, sleeve) electrically independent self-aligning plugs, on .625 inch (15.875mm) centers. Mates with all standard 3 conductor jacks. Shell notched for polarity. Standard shell color black.Part # TC-W425



W478 Plug

TC-W478 adapts modular handset or headsets to plug into standard PBX dual jacks (223A, 226A, etc.) 4 conductor 616P modular jack mounted in rear of shell is wired to PJ327 plugs mounted in shell on .625 inch (15.875mm) centers. Standard shell colors beige or black..Part # TC-W478

TOOLS

Terminal Lug Cap Puller

Terminal Lug Cap Puller.
Terminal Lug Cap Puller.....Part # TC-TLCP



Tel-Line Tester Porta

Porta Tel-Line Tester
Tel-Line Tester Porta.....Part # TC-TLTS-1P



Headset Adapter

Adapter plug allows use of standard PBX/ACD headset with modular telephones. PBX headsets equipped with the standard PJ327 dual brass plug may now plug into telephone consoles with 4X4 jack.
Headset Adapter.....Part # TC-PTL6BG



Banjo (Modular Line Tester)

Looped plug-in (P2FM equivalent) used in recess test terminal for shorting purposes. (for AT&T 310)
Banjo (Modular Line Tester).....Part # TC-BJ100Y



Lugs to 346A

16" cord, lugs to 346A plug. Mates with the 471A Jack (Quick disconnect WECO type).
Lugs to 346A.....Part # TC-H2C



Lugs to 346A to HSC TS44

16" cord, TS44 lugs to 346A plug. For Buttset
TS44 Lugs to 346A.....Part # TC-161753



PREMISE INSTALLATION KIT

Quick Access to 66 and 110 Block Connectors

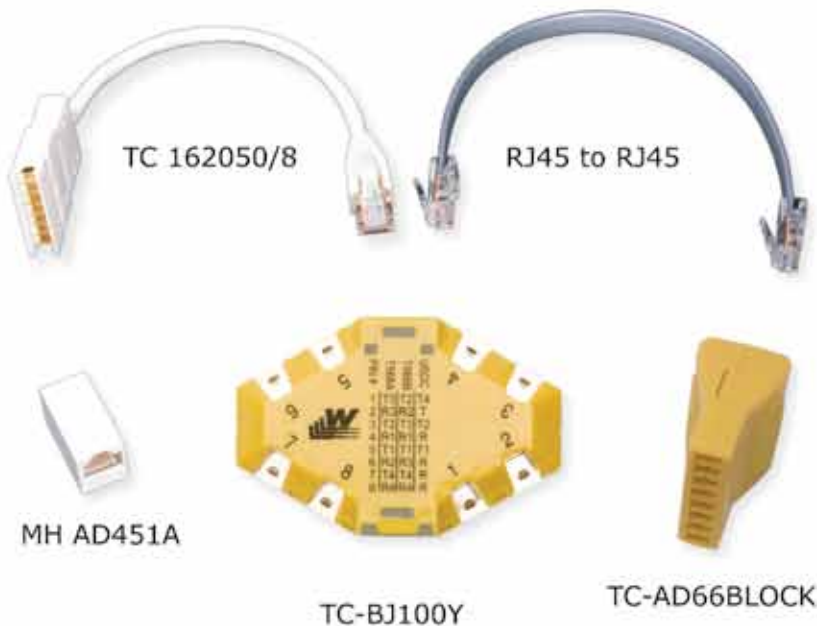


Westek's Premise Installation Kit allows easy access to multiple terminal applications. Now, you can access 66 Block, 110 Block and RJ45/48 8 position modular ports all with one simple kit. The Premise Installation Kit comes with a convenient carrying case and has a belt loop to keep every part within arms reach for quick and easy access.

Premise Installation Kit
Part # KT 290533



KT 290533 Kit includes:



PRODUCT HIGHLIGHTS

Converts 66 & 110 block connectors to RJ45 for quick, easy access to pairs.

Provides fast access to each wire allowing Butt Set or Test Set clips to access cable pairs

Convenient carrying case with belt loop so your tools are always within easy reach

Test up to 4 pairs at a time with Westek's Banjo

Eliminates touching or moving other connectors preventing service disruption

“One Tech, One Ticket”

The OSP Combi-Cord accesses all necessary plug-ins to allow easy testing of POTS, ADSL and VDSL at the SAI, RT, NID or RJ11 jack. It works with all major test sets and tone generators and is warranted for two years. With the right OSP time saving tools from Westek, one technician can tackle one ticket. The new Combi-Cords are your tool to excel in productivity.



The patented Tel-Line Tester Pro automatically splits the Central Office from the OSP field! Access cable pairs by plugging into any 5 pin cable block located at the building entrance. (SLC Remote, CEV, or Central Office)



KT-291052
TLTS Pro Kit



TC-OSPEFHQ
Combicord

TC-OSPACGN
Combicord



OSP Product Training!

Westek is here to help improve OSP ticket efficiency! In the face of the ever increasing data load that is being carried by legacy equipment, Westek has been working closely with technicians to design testing cords and procedures that will save time and increase efficiency.

This has led to the development of Westek's new OSP Approved Product Training series led by our field experienced trainers. This is the latest edition to our popular Tele-communications Training Program. Call to schedule your garages for participation in Westek's OSP Product Training Program.

Please call for your appointment 800.526.2673



Just Flip It.

The OSP Buttset Replacement Cord provides our patented water proof line cord connection with strain relief, and snagless RJ11 jack.

TC-162202

The Banjo Pro features eight conductor data testing while plugging in the black RJ45. "Just Flip It", for POTS testing of two, four, and six conductor scenarios with the red RJ11 plugged in.

TC-BJ100-PRO

Quality Assurance

Westek Electronics, Inc.



Is certified through Lloyd's of London Register Quality Assurance
and conforms to its Quality Management System Standards:

ISO 9001:2008 & TL 9000

This Quality Management System is applicable to the following:

Development and Toll Manufacturing of Test Cords
and Cables for the Telecommunications Industry.

Certificate is available upon request.
Call us at: 1 (800) 526-2673





WESTEK
Electronics, Inc.
www.westek.com