



CenturyLink MC Guide



WESTEK ELECTRONICS, INC., IS NOW TL9000 5.0 CERTIFIED

Westek is proud to announce the successful passing of our LRQA (Lloyd's Register Quality Assurance) Surveillance audit and "upgrade" to the TL9000 5.0 Manufacturing Standard! Westek is the 4th company over all in the USA to be standardized to the upgraded ISO 5.0 Manufacturing Standard.

"We could not be more proud of our team achieving this level of ISO certification. Our growth and continual improvement is a reflection of the well trained and dedicated staff." States, Michael Hushaw, Vice President Operations.

Westek Electronics, Inc. was the First Telecommunication Cable Manufacturer in the world to be certified to the LRQA (Lloyd's Register Quality Assurance) Re-Certification audit and "upgrade" to the ISO 9001:2008 standard back in August 2009.

Westek Electronics, Inc. is located in Santa Cruz County, at 314 Westridge Dr., Watsonville, CA 95076. For more information on Westek Electronics, Inc. products and services go to: www.westek.com or call 800-526-CORD.

About Westek: Westek Electronics, Inc. has been a leader in Telecommunications for over 25 years. Westek Electronics, Inc. also specializes in the Test & Measurement, Medical and Military/GSA industries. Westek Electronics Inc., holds dual certification, as audited by LRQA (Lloyds Registry Quality Assurance), in regard to ISO 9001:2000 since 1999 (now 9001:2008) and TL9000-H since 2003. Westek Electronics, Inc. was the 6th company in the United States to be certified to revision 4.0 in TL 9000.





800.526.2673 www.westek.com

TL9000



Bicsi

Test right the first time with Westek's patented tools that will expedite job tickets.

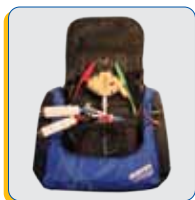

NIU Kit



Banjo Pro

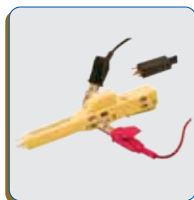

Tel-Line Tester Pro

The OSP product line reduces truck rolls, saves time and promotes productivity by having all of the necessary testing tools needed on the job.

Combi-Cords

TC-OSPEFHJ
MC# 1164949

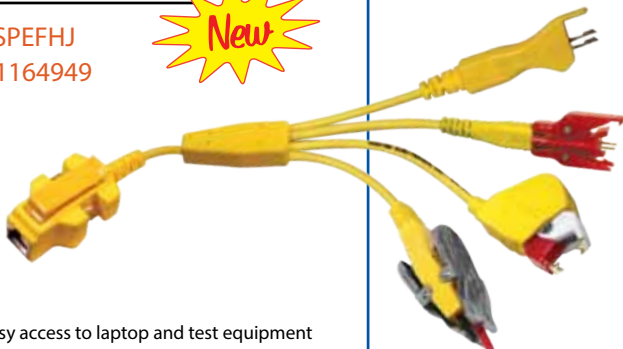

Quick easy access to laptop and test equipment
Weather resistant to withstand outside elements

Connectors:
Binding Post Clip, Self Strip Clip, 3M, RJ11

www.westek.com/osp
or call 1.800.526.2673 to speak
with your regional telecom
sales representative today!

Individual Parts

P/N TC-CLAMP11	Description	Function	MatCode
	11in clamp, FOSC V2 w/tube adapter	creates a stable work platform. works with Westek FOSC brackets, vise, fiber work tray, and fixturing brackets.	1351272
	18in clamp, FOSC V2 w/tube adapter	creates a stable work platform. works with Westek FOSC brackets, vise, fiber work tray, and fixturing brackets.	1351273
	Fiber Splicing work tray, Large 24in x 12 with Adapter post.	Adapter posts Male thread end mounts to Westek fiber work tray and 710 punchdown. Mates with Westek Table top Mount, FOSC clamps, and brackets.	1351274
	Wall/ Table mount FOSC post reciever	Designed to be permanently mounted to the fiber work station table in the trailer and wall mounted in MDU closets. creates a stable work platform. Works with Westek FOSC brackets, vise, fiber work tray, and fixturing brackets.	1351275
	Work Station Tripod with retractable spike. "PATENT Pending"	Provides a secure platform to mount Westek fiber splice tray, LED flood lights, 710 punch down and other accessories. Retractable spike inserts into soil, snow, and gravel for additional stability.	1351276
	Clip on tray for fiber cleaning products.	Securely Mounts to Westek fiber splice trays. Holds Fiber cleaning and prep products for easy access while fusion splicing.	1351277

Kits

KT LEDFLDHC	Description	Function	
	<p>Patent Pending 1500 LED Flood with spring clamp and bracket adapters.</p>	<p>Spring clamp attached to safety rails, ladder rungs, and 2x4's. Bracket adapters made with Westek Clamp, FOSC Tube, Table mount, and brackets.</p>	<p>1351278</p>

KT LEDDLDA	Description	Function	
	<p>Kit , 4500 Lumen LED flood with aerial strand mount</p>	<p>8-14 hr runtime. 8 hr charge time. Light weight heavy duty Lexan type non yellowing lens (unbreakable). Heavy duty frame with (6x) 112lb neodymium magnets. Provides secure mounting to aerial strand and utility pole.</p>	<p>1351279</p>

KT CL2T2MTT	Description	Function	
	<p>Deluxe Fiber Splicing work station, Large Tray 24in x 12 with 11 & 18in FOSC clamp and rolling travel case.</p>	<p>Fully adjustable workstation includes FOSC Splice table, FOSC clamp, Universal endplate fixture, Wall mount adapter, adapter posts, ixturing brackets, and Rolling travel case.</p>	<p>1351280</p>

KT CL2T2A	Description	Function	
	<p>Fiber Splicing work station, Large Tray 24in x 12 with 11 & 18in FOSC clamp.</p>	<p>Fully adjustable workstation includes FOSC Splice table, FOSC clamp, Universal endplate fixture, Wall mount adapter, adapter posts, and fixturing brackets.</p>	<p>1351281</p>

Kits

KT CLCAP	Description	Function	
 <p>(KT CL2T2MT)</p> <p>(KT CL2DLEDST)</p>	<p>Delux Combo Fiber Splicing work station, Large Tray 24in x 12 with 11 & 18in FOSC clamp, 11 and 18in clamp with dual light bracket and (2x) 1500 lumen LED flood lights.</p>	<p>Fully adjustable workstation includes FOSC Splice table, FOSC clamp, Universal endplate fixture, Wall mount adapter, adapter posts, and fixturing brackets. Dual LED Flood light kit includes 11 & 18in clamp, dual Light bracket, (2) 1500 lumen LED flood lights, 90 deg adapter, and rolling travel case.</p>	<p>1351282</p>

KT CLAMP 11	Description	Function	
	<p>11 inch clamp, FOSC V2 with FOSC adapter tube and vise</p>	<p>Creates a stable work platform. Works with Westek FOSC brackets, vise, fiber work tray, and fixturing brackets</p>	<p>135664</p>
<p>KT CLAMP 18</p>	<p>Description</p>	<p>Function</p>	
	<p>18 inch clamp, FOSC V2 with FOSC adapter tube and vise</p>	<p>Creates a stable work platform. Works with Westek FOSC brackets, vise, fiber work tray, and fixturing brackets</p>	<p>1356641</p>
<p>KT SC3</p>	<p>Description</p>	<p>Function</p>	
	<p>FOSC universal end plate fixture</p>	<p>3-in-1 FOSC splice case tray mounting brackets for multiple manufacturers fiber splice cases. 3-in-1 supports TYCE (Comm-scope) and PLP (COY-OTE). Color coded for identification. Includes post adapter</p>	<p>1356642</p>

NEW

CenturyLink Fiber Multi-Tool Solution

Male Loopback, Female Loopback, Plug-in Connector Coupler & Parking Lot

Four Fiber Tools in One Pat. Pend. LC or SC

1. Dual LC or SC Male Plug for Loopback Electronics Testing
2. Dual LC or SC Female Plug for Loopback Cable Testing
3. Dual LC or SC Female Loopback
4. Park your exposed cable fiber plug ends, keeping them clean and damage free

Slide all three components together to create a dustproof, crushproof and moisture resistant case

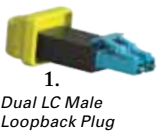

1.
Dual LC Male Loopback Plug

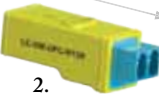

2.
Dual LC Fiber Coupler



3. Dual LC Female Loopback Plug
4. Also Park your exposed Fiber ends keeping them clean and damage free



1.
Dual SC Male Loopback Plug



2.
Dual SC Fiber Coupler

3. Dual SC Female Loopback Plug
4. Also Park your exposed Fiber ends keeping them clean and damage free



LC



Duplex LC Singlemode UPC 9/125
FC LB7102
MAT CODE 1336709

Duplex LC Multimode UPC 62.5/125
FC LB7202
MAT CODE 1336710

Duplex LC LO Multimode 50/125
FC LB7502
MAT CODE 1336711

Duplex LC Singlemode APC 9/125
FC LB7102A
MAT CODE 1336712

SC



Duplex SC Singlemode UPC 9/125
FC LB3102
MAT CODE 1336713

Duplex SC Multimode UPC 62.5/125
FC LB3202
MAT CODE 1336714

Duplex SC LO Multimode UPC 50/125
FC LB3502
MAT CODE 1336715

Duplex SC Singlemode APC 9/125
FC LB3102A
MAT CODE 1336716



Partner For Fiber Success

WESTEK'S ALL NEW FIBER TOOL

For Fiber Optic LC Plug Insertion and Removal

Westek's Fiber Tool installs and removes LC connectors. This elegant device simply fits into a shirt pocket or tool pouch and is ergonomically designed to fit the hands of today's technician while at the same time mitigates any potential for repetitive motion or significant squeeze issues/injuries. Supports most Fiber optic connectors and exceeds the stringent requirements dictated by Telcordia Technologies, ANSI, OSHA, FDA, NTA and the ICE.



Fiber Tool - FP 360023 *
MAT CODE 1183426

- Integrated flashlight feature enables tech to see in low-lit areas
- Extremely well balanced with ergonomic pads that provide the minimum pressure necessary to capture/place the connector
- Eliminates from touching or moving other connectors preventing service disruption
- Patented locking ratchet design to hold plugs securely
- Designed to fit comfortably in either hand
- One Year Warranty



MQ1000 • Rev. 3 • 01/2010

TL9000

Bicsi'

WWW.WESTEK.COM
ORDER ONLINE NOW

WESTEK
Electronics, Inc.

ph: 800-526-CORD fax: 800-526-FAXX Expect the Best.

TO SEE OUR COMPLETE LINE OF TIME SAVING
TECH TOOLS ALONG WITH ONLINE ORDERING
PLEASE VISIT US AT: WWW.WESTEK.COM

Linesman Technician Copper Test and Repair test kit

- Test and trouble shoot Copper lines
- Install Twisted Pair lines
- Rugged test cables and connectors
- Patented designs
- Other kits available for pair bond testing and fiberoptics.
- Increase productivity quality and pair access by having all the tools

Material Code 1359432



P/N: KT LINE1BL

P/N	Description
CB 05191 LGO	Carry Case
TC-BJ100-PRO	Banjo Pro with RJ11 an RJ45 Y Cable
TC-SD100	Screw Driver 2 in 1
TC-TLTS 1A	Tel-line tester
TC-162241	L4 to to L4 cradle
TC-OSPE	RJ11 female Clip Access to Binding post clip
TC-OSPH	RJ11 female Clip Access to Self Strip clip
TC-RJ45LSRYEL/1	RJ45 L-Plug to RJ45 L-Plug



- **Network Interface Device "NID"**
- **Serving Area Interface "SAI" box**
- **Test and trouble shoot Copper lines**
- **Rugged test cables and connectors**
- **Patented designs**
- **Increase productivity quality**
- **Inquire about other specialty connectors**



e. Binding post
TC-OSPE

Material Code 1359433



h. Self strip
TC-OSPH

Material Code 1359434



j. 2827 clip
TC-OSPJ

Material Code 1359435



s. RLS50
TC-OSPS

Material Code 1359436

Ph: 800.526.2673

Fax: 800.526.3299

www.westek.com

Central Office Tech Fiber Kit

Ph: 800.526.2673 Fax: 800.526.3299

WWW.WESTEK.COM

KIT PN:
KT COTFK



LC
Single Mode UPC
MAT CODE:
1336709



SC
Single Mode UPC
MAT CODE:
1336713



Rugged LC/SC Fiber Loopback Plugs
With Coupler and Parking Lot in
Heavy Duty Unbreakable Waterproof
Case with Lanyard

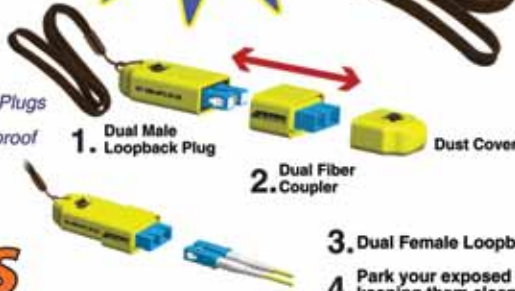

1. Dual Male Loopback Plug

2. Dual Fiber Coupler

Dust Cover

3. Dual Female Loopback Plug

4. Park your exposed fiber ends
keeping them clean and damage free

3 Tools In One Kit!

PATENTED

Fiber Install & Removal Tool with Built in Flashlight



FOR FIBER OPTIC SC/LC PLUG
INSERTION AND REMOVAL



KIT BAG INCLUDED
FOR EASY TRANSPORT



Your World. Connected.

OSP Construction Fiber Kit

Ph: 800.526.2673 Fax: 800.526.3299

WWW.WESTEK.COM



KIT PN:
KT CONTFK



SC
Single Mode UPC
MAT CODE: 1336713



SC
Single Mode APC
MAT CODE: 1336716



SC Fiber Loopback Plugs

Rugged SC Fiber Loopback Plugs
With Coupler and Parking Lot in
Heavy Duty Unbreakable Waterproof Case
with Lanyard

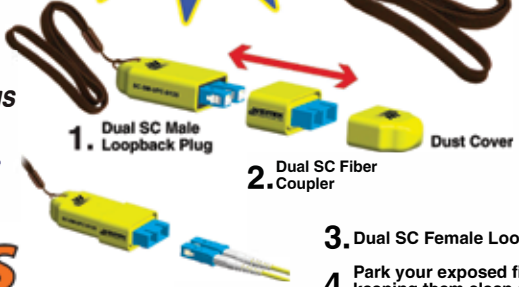

3 Tools In One Kit!

1. Dual SC Male Loopback Plug
2. Dual SC Fiber Coupler
3. Dual SC Female Loopback Plug
4. Park your exposed fiber ends keeping them clean and damage free

PATENTED

Fiber Install & Removal Tool with Built in Flashlight



FOR FIBER OPTIC SC/LC PLUG
INSERTION AND REMOVAL



KIT BAG INCLUDED
FOR EASY TRANSPORT

Ph: 800.526.2673

Fax: 800.526.3299

www.westek.com

PREMISE INSTALLATION KIT

Patented

Quick Access to 66 and 110 block connections, RJ11, RJ45

Westek's Premise Installation Kit allows easy access to multiple terminal applications. This kit contains the components and tools to access multiple terminal applications. Access to 66 Block 110 Block, RJ11, and RJ45.

This kit contains the most essential tools for telecommunications professionals making it ideal for maintaining and troubleshooting your network. The Premise Install kit features Westek's patented solutions that increase tech productivity, eliminate breakage and ensure more accurate testing.



Kit Bag



TC-CPLR45



TC-AD66Block

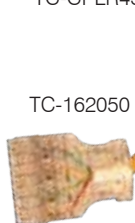

TC-162050



TC-BJ100PRO

Just Flip It.

- **Data Testing**
 Plug in **Black RJ45**
 for 8 conductor testing
- **POTS Testing**
"Just Flip it."
 Plug in **RED RJ11**
 for 2,4,6 conductor testing

To succeed in this information and communication driven world, you need reliable products and world class support. Westek is committed to providing quality products, on time delivery and unbeatable customer support. Thank you for being a valued customer. [800.526.2673](tel:800.526.2673)





WESTEK
Electronics, Inc.

Providing Excellence in Connectivity
for 30 years strong.

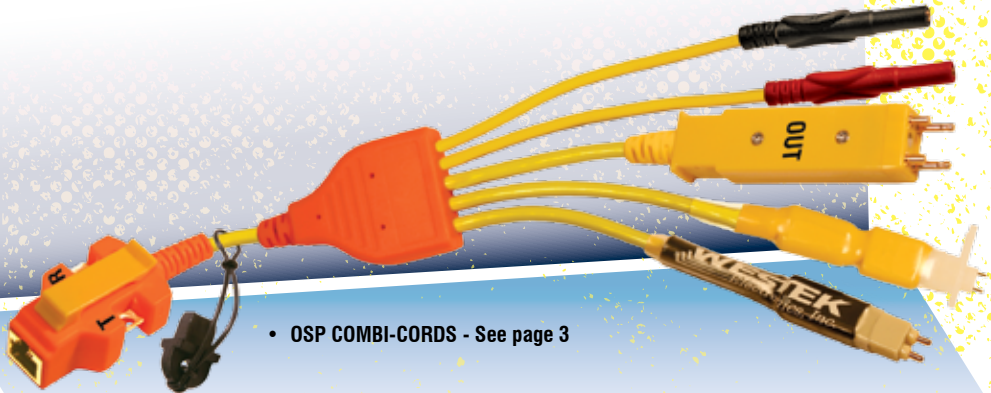

• OSP COMBI-CORDS - See page 3



Table of Contents

OSP Products.....	3-11
OSP Combi-Cords.....	3-5
Cord Kits.....	12-19
Bantam Cords.....	20-24
310 Cords	25-27
Porta Cords	28-29
463A Cords.....	30-32
Coax Cords (DSX3).....	33-41
800 DSX Cords.....	42-43
AT&T Replacement Cords.....	43-48
Modular Cords.....	49-53
Data Communication Cords.....	54-56
JDSU Far End Device Kit.....	58-59
Combi-Cords.....	60-69
Looping Plugs, Terminators & Adapters ...	70-72
T-Berd Test Cords.....	73
Testers.....	74-75
Miscellaneous.....	76
Tools.....	77
Pair Bonding.....	78-79

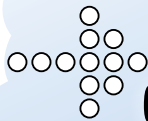

One Tech, One Ticket.

Reduce Repeat Repairs

The OSP product line reduces truck rolls, saves time and promotes productivity by having all of the necessary tools needed on the job.

Test right the first time! With the OSP time saving tools from Westek, one technician can tackle one ticket.



NIU Cord Kit
MC# 1165007



Laptop Kit
MC# 1164933



Tel-Line Tester Pro
MC# 1165025



Combi-Cord
TC-OSPEFHQ
MC# 1185167

WESTEK
Electronics, Inc.

OSP Combi-Cords

WESTEK CABLE AND TEST SOLUTIONS

OVERVIEW

Westek's OSP Combi-Cord is a multiended test cord that allows technicians to access various types of terminal and connector blocks with one cable. OSP Combi-Cords provide technicians with all the necessary plug-ins on a one foot cable.

FEATURES AND BENEFITS



- More productive circuit testing by having four different test plugs on one test cord.
- Easy testing of POTS, ADSL and VDSL.
- Works with all major test sets and tone generators.
- Test clips for easy butt set access.
- 7" Lanyard for weight relief.
- Reduced truck rolls by having four different test plugs on a single cord.
- No more loosing of multiple test accesscords.
- Cost savings by replacing four test cords with one multi connector test cord.
- Manufactured to the highest industry standards.
- Belt clip for easy transportation.
- Protective dust covers for RJ11, 5 pin L4 (463A) and L3 (526) connectors.
- RJ-11 looping plug available.
- Molded in bright yellow to prevent misplacement.
- Designed to fit most tool pouches.
- 2 year warranty.

SPECIFICATIONS

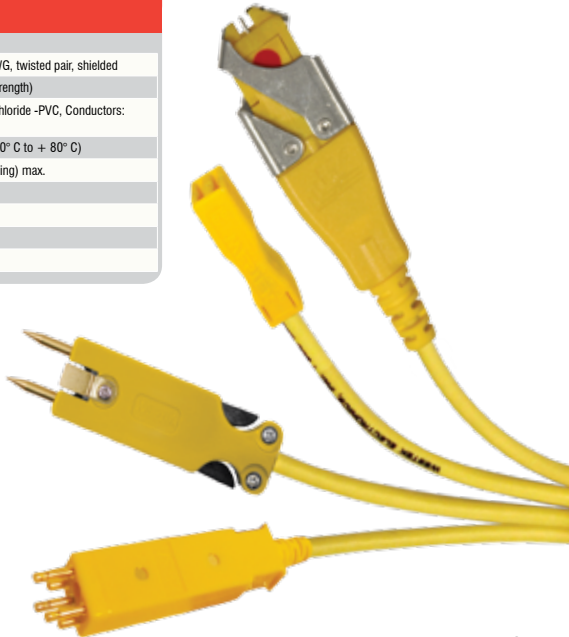

Cable	2 Conductor, 24AWG, twisted pair, shielded
Voltage	500V (Dielectric Strength)
Insulation	Jacket: Polyvinyl Chloride -PVC, Conductors: Polypropylene
Operating Temperature	-4° F to 176° F (-20° C to + 80° C)
Humidity	90% (non-condensing) max.
Length	12 inches (31 cm)
Weight	5 oz (150 g)
RJ11 Looping Tool	PN: TC-LE11LOOP



OSP Combi-Cords

	MC #	Description	Part #
	1185167	<p>Combi-Cord Isolated Self Strip Binding Post Binding Post Clip Dat-Term Clip RJ11LE</p>	TC-OSPEFHQ
	1164807	<p>Combi-Cord Isolated Self Strip Binding Post Binding Post Clip Dat-Term Clip 66 Block</p>	TC-OSPCEFH

OSP Combi-Cords

	MC #	Description	Part #
	1164945	<p>Combi-Cord</p> <p>Isolated Self Strip Binding Post</p> <p>Binding Post Clip</p> <p>Dat-Term Clip</p> <p>110 Block</p>	TC-OSPAEFH
	1164949	<p>Combi-Cord</p> <p>Isolated Self Strip Binding Post</p> <p>Binding Post Clip</p> <p>3M</p> <p>Dat Term</p>	TC-OSPEFHJ

Notes Page / Ordering Check List



NEW FROM WESTEK



Patent Pending



OSP / CO Hybrid Combi-Cord

Introducing the newest solution for the OSP/CO
TC-HYBNRU

MC# 1329327

Many OSP techs have the necessity to test at unmanned COs. The new Outside Plant Combi-Cord is designed to give these technicians what they need to service the CO during unmanned hours/days. The response from the field was to make a cord with CO components for quick access, with Westek's proven OSP cord durability. With this valuable insight we designed the Hybrid cord for reliable utility when it,s needed most.

Put testing excellence in your hands.
Inquire with your Westek Regional Service Manager.
800.526.2673

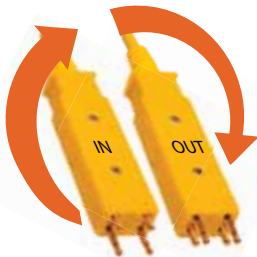

Look in to CO with the 5 pin 463A
Turn 180 degrees to look out to the field

TC-HYBNRU
Clip Access/RJ11
L7 Chuck Ends
5 Pin 463A
P2FM
P2EF

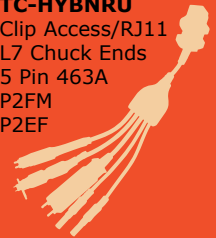

TEL-LINE TESTER™ KIT

OSP Troubleshooting Kit Now Cable Maintenance Technicians Can Troubleshoot Cable Pairs Fast!

Important time saving tool kit for cable maintenance. Now troubleshoot cable pairs in seconds and eliminate repeat repairs. Look into the central office or out to the field in seconds!

The Tel-Line Tester™ automatically splits the central office from the field! Access cable pairs by plugging into any five pin connector block located at the building entrance (SLC remote, CEV, or Central Office).

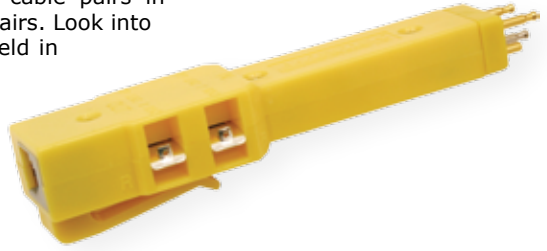

To troubleshoot the switch, simply clip a buttset or voltmeter to the metal tabs marked "Tip" and "Ring In" and look to the switch. Move the clips to the tabs marked "Tip" and "Ring Out" and look to the field. To restore temporary service to the customer while troubleshooting, simply plug in the OSP kit's modular looping tool. The Westek Tel-Line Tester™ facilitates Bell System Practice (BSP). Connect a Craft access terminal or Trans Test Access Network to close out the trouble and pull up the next job ticket.

Product Highlights

Access 5 pin location at building entrance, CEV, SLC remote, and Central Office

Isolate Central Office from field

No need to disconnect pairs

Built tough and durable

Full two year warranty



800.526.2673 www.westek.com

TL9000



Bicsi

KT-291052

Tel-Line Tester Pro™

Allows you to troubleshoot cable pairs in seconds

PATENTED

Light your way to a solution



-Three Step Testing-



STEP 1: REMOVE PROTECTOR

Access using 5 Pin Protector at building entrance, CEV, SLC remote and Central Office with protection. Removes the need to physically cut into the line to isolate the pair.

STEP 2: TEST PROTECTOR

Insert protector into Tel-Line Tester Pro. Press "Test" Button. Test light LED glows **Green** if protector is good, and **Red** if the protector is bad. A white LED flashlight is located at the tip for locating target.

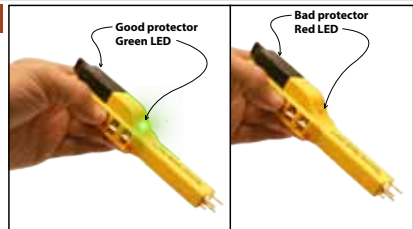

STEP 3: TROUBLESHOOT

Clip a buttset or voltmeter to the metal tabs marked "Tip" and "Ring in" and look to the switch. Move the clips to the tabs marked "Tip" and "Ring out" and look to the field. To restore temporary service to the customer while troubleshooting, simply plug in the OSP kit's modular looping tool.

Tel-Line Tester Pro Kit

MC # 1165025

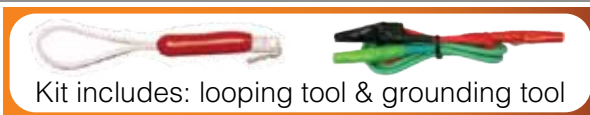

Kit includes: looping tool & grounding tool

Ph: 800.526.2673

www.westek.com

Fax: 800.526.3299

RFL Test Set Replacement Cord Kit

KT Banana
MC# 1165006

RFL test set replacement cord kit
(includes all three pictured cords)



TC-3300BPGN (5')
R/A Banana Grn to LHTCABP Grn
MC# 1164963

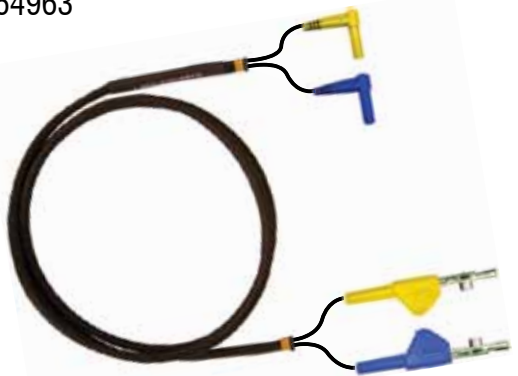

TC-3300BPYB (5')
2 R/A Bananas Yel/Blu to 2
LHTCABP Yel/Blu
MC# 1164965

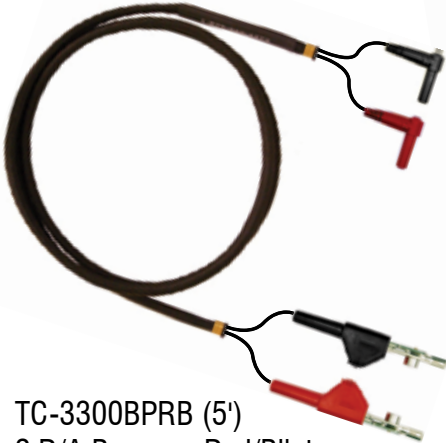

TC-3300BPRB (5')
2 R/A Bananas Red/Blk to
2 LHTCABP Red/Blk
MC# 1164964





800.526.2673 www.westek.com



Buttset Replacement Cord



TC-162202 [TS44]
MC# 1164988



Buttset not included



TS22



TS44

Patented Waterproof
Line-Cord Connection
With Strain Relief



Patented Snagless
Modular RJ11 L-Plug

Built in RJ-11 allows the
user to plug directly into
wall jacks, or the
residential Network
Interface

Ph: 800.526.2673

www.westek.com

Fax: 800.526.3299

2099 "Q:" OSP



MC # 1164931

Part # KT 290374

Kit Contents	Part Number	MC
RJ48 to Bantam Y 8'	TC-TR248C	1066863
Bantam to 310 Red 8'	TC-230RX	1047145
Bantam to 310 Blue 8'	TC-230TX	1047146
RJ45- RJ45 CAT5e Blue 10ft	TC-140	1164975
463A to Alligator Clips(2) 3ft	TC-W2GL	1164992
Bantam to Alligator Clips(2) 8'	TC-260	2188227
463A to Bantam Looking O ut 8'	TC-5P600	1049744
Tel-Line Tester™	TC-TLTS1A	1049936
Cord Bag	TC-PO1	1164937

NIU Cord Kit



MC # 1165007

Part # KT 291064

Kit Contents	Part Number	MC
Kit Bag CB	CB 05190000	1164977
Banjo - Yellow with RJ45 Lan Cord	TC-BJ100Y	1164719
(4) Round Lugs Y 463A Looking In	TC-162140	1229880
Protect Cradle-(2) Alligator Clips, Red&Black	D1-250151	1164961
Protect Cradle-(2) Alligator Clips, Green&Yellow	D1-250154	1164960

Ph: 800.526.2673

Fax: 800.526.3299

www.westek.com

Field Technician Central Office Bridge Kit



MC # 1164768

Part # KT 290461

Kit Contents	Part Number	PID
Tel-Line Tester™	TC-TLTS 1A	1164980
Tel-Line Tester™ w/Ground Connect	TC-TLTS G	1164979
L4 Female-Molded RJ-11 Adapter	TC-TLTS 4A	1183423
L4(463A) Frogging Cord 8'	TC-5PFROG	1164671
Looping Tool, RJ-11	TC-TLTS-12	1165024
Cord bag	CB 05190 000	1164977
Ground Start Cord	TC-TLTS14	N/A
Shorting Plug 463A Red	TC-161768	1164976
Shorting Plug 463A Black	TC-161771	1165008
463 (ring) Resistance Bridge	TC-161774	1164967
463 (tip) Resistance Bridge	TC-161777	1183422
Wrist Strap (anti-static)	TC-WS100	1164711

209 "Q:" OSP



MC # 1164930

Part # KT 290377

Kit Contents	Part Number	PID
RJ48 to 310 Y 8'	TC-TR348C	1164664
Bantam to 310 Red 8'	TC-230RX	1047145
Bantam to 310 Blue 8'	TC-230TX	1047146
RJ45- RJ 45 CAT5e Blue 10ft	TC-140	1164975
463A to Alligator Clips(2) 3ft	TC-W2GL	1164992
Bantam to Alligator Clips(2) 8'	TC-260	1164983
463A to Bantam Looking Out 8'	TC-5P600	1050035
Tel-Line Tester™	TC-TLTS1A	1164980
Cord Bag	TC-PO1	1164937

Ph: 800.526.2673

Fax: 800.526.3299

www.westek.com

DSX3 Coax Test Kit



MC # 1119722

Part # KT 290041

Kit Contents	Part Number	MC
1 - BNC to BNC 8' Red Cord	TC-500RX	1164764
1 - BNC to BNC 8' Blue Cord	TC-500TX	1164765
4 - 440A to BNC Adapter	TC-AD440	1119368
4 - 358A to BNC Adapter	TC-AD358	1109726
1 - Cord Bag	CB 05190	1164977

Universal Laptop Test Kit



MC # 1164933

Part # KT 290152

Kit Contents	Part Number	PID
1 - 25 pin Male to 9 pin Female, 10' Cord - special wiring	TC-25M9F/10	1164645
1 - 9 pin Male to 9 pin Female, 10' Cord - straight wiring	TC-9M9F/10	1164706
1 - DB9 Female to Female, Gender Changer	TC-GCPC9F	1164702
1 - DB9 Male to Male, Gender Changer	TC-GC9M	1164703
1 - DB25 Male to Male, Gender Changer	TC-GCPC25M	1164651
1 - DB25 Female to Female, Gender Changer	TC-GCPC25F	1164650
1 - 25 pin Male to 25 pin Female, Low Profile Null Modem	TC-NM100LP	1164646
1 - 9 pin Male to 9 pin Female, Low Profile Null Modem	TC-NM900LP	1164646
1 - RJ48C Shorting Tool	TC-LPRJ48C	1164947
1 - RJ48 Ethernet Looping Plug	TC-LPRJ48E	1164646
1 - Westek Screwdriver	TC-SD100	N/A
1 - Westek Flashlight	TC-FL100	N/A
1 - ESD Wrist Strap	TC-WS100	1164711
1 - Cord Bag	CB 05190 000	1164977

Ph: 800.526.2673

Fax: 800.526.3299

www.westek.com

T-BERD 209 Cord Kit



MC # 1164934

Part # KT 290026

Kit Contents	Part Number	PID
1 - 310 to 463A, Alligator Clips and holstered Bantam 15' Blue Cord	TC-323 TX	1164771
1 - 310 to 463A, Alligator Clips and holstered Bantam 15' Red Cord	TC-323 RX	1164770
1 - 15 pin Female to "Y" 310, 2' Cord	TC-15F310/2	1164641
1 - Dual Bantam to Female 310, 1' Blue Cord	TC-227ATX/1	1183412
1 - Dual Bantam to Female 310, 1' Red Cord	TC-227ARX/1	1183413
1 - Westek Screwdriver	TC-SD100	N/A
1 - Westek Flashlight	TC-FL100	N/A
1 - RJ48 to RJ48, 10' Royal Blue Cord	TC-140	1164975
1 - 310 to Bantam Adapter Blue	TC-AD310B	1164707
1 - 310 to Bantam Adapter Red	TC-AD310R	1104787
1 - Cord Bag with Westek Logo	TC-P01	N/A

T-BERD 2209 Cord Kit



MC # 1164978

Part # KT-290038





Kit Contents	Part Number	PID
Combi-Cord, Male Bantam Plug to 2 Alligator Clips, Holstered Bantam and Shielded 463A	TCC-232TX TCC-232RX	1164813 1164812
100ohm Bantam Terminating Plug (Quantity 2)	TC-TP200	1164721
Tel-Line Tester™	TC-TLTS1A	1164980
TAD3 Female Bantam to Male 310 Adapter (one each,Red/Blue)	TC-AD310B TC-AD310R	1164707 1164787
RJ48 to RJ48 10' (Quantity 2)	TC-140	1164975
440A to 440A 8' (one each,Red/Blue)	TC-440 ATX TC-440ARX	1164670 1164669
Bantam "Y" to RJ45 Female	TC-16118	1164969
Bantam "Y" to RJ48C/DS1 8'	TC-TR248C	1066863
RJ48 Looping Plug for T1	TC-LPRJ48C	1164974
BNC to BNC Coupler	TC-BNCCPLR	2438960

Ph: 800.526.2673



Fax: 800.526.3299

www.westek.com





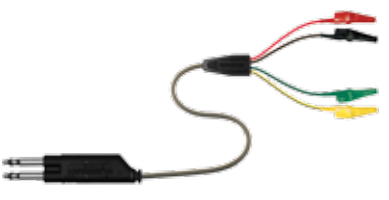
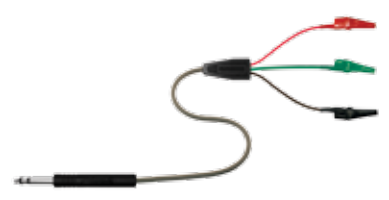

Bantam Cords

	MC #	Description	Part #
		Bantam to Bantam	
	1164739	2' Cord	TC-200/2
	1164742	4' Cord	TC-200/4
	1164744	6' Cord	TC-200/6
	1030570	8' Cord	TC-200
	1047140	10' Cord	TC-200/10
	1109711	12' Cord	TC-200/12
	1164736	18' Cord	TC-200/18
	1164737	20' Cord	TC-200/20
	1164738	25' Cord	TC-200/25
	1073508	30' Cord	TC-200/30
	1164740	35' Cord	TC-200/35
	1164741	45' Cord	TC-200/45
	1183525	50' Cord	TC-200/50
	1164743	60' Cord	TC-200/60
		Bantam to 310	
	1164728	6' Cord	TC-230/6
	1030569	8' Cord	TC-230/8
	1164725	10' Cord	TC-230/10
	1164726	12' Cord	TC-230/12
	1109703	20' Cord	TC-230/20
	1108042	30' Cord	TC-230/30
	1108043	40' Cord	TC-230/40
	1165013	50' Cord	TC-230/50
		Bantam to 5 pin Protector	
	1164732	Bridging	TC-5P200B
	1164684	Non-Bridging	TC-5P200NB
		CORD DUAL BANTAM WITH 463A (non-Bridging)	
	1164920		TC-5P250
	1164917		TC-5P250/4.6
	1165017		TC-5P250/16
	1164624		TC-5P250/20
1190547		TC-5P250/35	

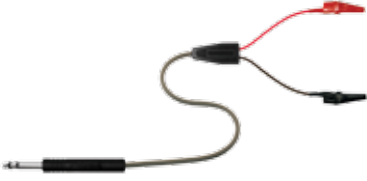





Bantam Cords

	MC #	Description	Part #
	1044886 1183383 1109709 1164921 1164922 1109710 1164923 1113690 1164627	Dual Bantam to Dual Bantam 3 Conductor 8' Cord 10' Cord 12' Cord 18' Cord 20' Cord 40' Cord 45' Cord 50' Cord 100' Cord	TC-250/8 TC-250/10 TC-250/12 TC-250/18 TC-250/20 TC-250/40 TC-250/45 TC-250/50 TC-250/100
	1164746 1109717 1109715	Bantam to Bantam 8' Red Cord 10' Red Cord 20' Red Cord	TC-200RX/8 TC-200RX/10 TC-200RX/20
	1164745 1109716 1109714 1164625 1108041 1165111	Bantam to Bantam 8' Blue Cord 10' Blue Cord 20' Blue Cord 24' Blue Cord 30' Blue Cord 50' Blue Cord	TC-200TX/8 TC-200TX/10 TC-200TX/20 TC-200TX/24 TC-200TX/30 TC-200TX/50
	1164919	Dual Bantam to 4 Alligator Clips 8' Cord	TC-256(4)
	1188912	Bantam to 3 Alligator Clips 8' Cord	TC-260(3)

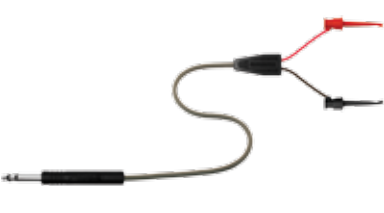
Bantam Cords

	MC #	Description	Part #
	1030494	Bantam to Alligator Clips, 8' Cord	TC-260
	1164733	Bantam to Alligator Clips, 10' Cord	TC-260/10
	1188911	Bantam to Alligator Clips, 12' Cord	TC-260/12
	1109712	Bantam to 66 Block 8' Cord	TC-266
	1079177	Bantam to Wire Wraps 8' Cord	TC-272/8
	1251519 1183386 1251520 1183387	Dual Bantam to Dual 310 8' Cord 10' Cord 12' Cord 20' Cord	TC-290 TC-290/10 TC-290/12 TC-290/20
	1044155	Bantam to Female 310 1' Cord	TC-203S
	1251522	Female Bantam to 310 Male 1' Cord	TC-300F

Bantam Cords



	MC #	Description	Part #
	1102648 1164748	Bantam to Minigrabbers	TC-240/6 TC-240/8
	1183382	Right Angle Bantam to Right Angle Bantam 8' Cord	TC-200(RA)
	1183412	Dual Bantam to Female 310 1' Blue Cord	TC-227ATX/1
	1183413	Dual Bantam to Female 310 1' Red Cord	TC-227ARX/1
	1120066	Dual Bantam to Alligator Clips 2' Cord	TC-256/2
	1164720	Female Bantam to Female Bantam 8' Cord	TC-020
	1112310	RJ45 to Dual Bantam 8' Cord	TC-259

Ph: 800.526.2673

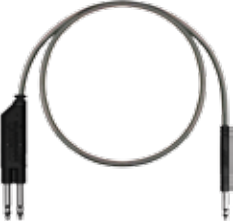

Fax: 800.526.3299

www.westek.com



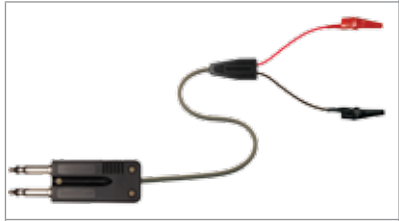
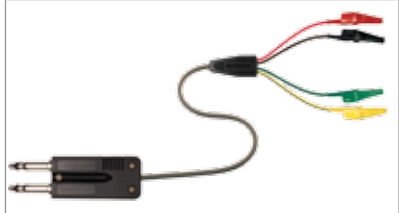
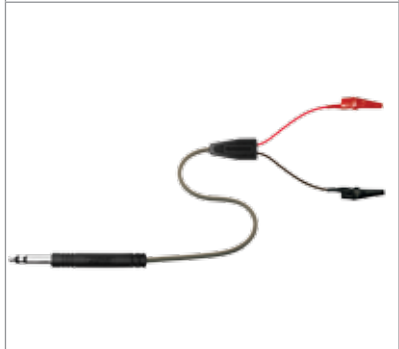
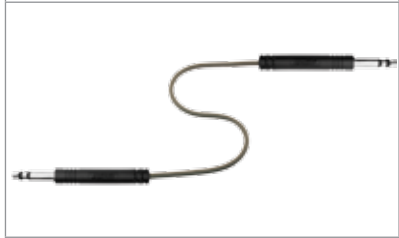

Bantam Cords

	MC #	Description	Part #
	1164747	BANTAM TO BNC	TC-220
	1183384	Dual Bantam to BNC	TC-252
	1183385	Dual Bantam to Single Bantam	TC-253
	1346084	NT Plug to (4) Alligator Clips	TC-153747



310 Cords

	MC #	Description	Part #
	1164915 1328113	Dual 310 to Alligator Clips 8' Cord 16' Cord	TC-356 TC-356/16
	1251523	Dual 310 to 4 Alligator Clips 8' Cord	TC-356(4)
	1030495 1164658 1164657	310 to Alligator Clips 8' Cord 310 to Alligator Clips 10' Cord 310 to Alligator Clips 20' Cord	TC-360/8 TC-360/10 TC-360/20
	1164666 1164667 1051478 1164656	310 to 310 1' Cord 6' Cord 8' Cord 10' Cord	TC-310/1 TC-310/6 TC-310/8 TC-310/10
	1183395	Dual 310 to Dual 310 8' Cord	TC-350





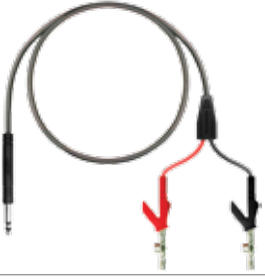
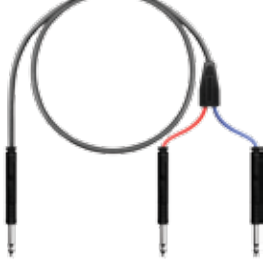

310 Cords

	MC #	Description	Part #
	1164664 1164655	Dual 310 to RJ45, wired 1245	TC-TR348C (8') TC-TR348C (10')
	1164665	Dual 310 to RJ45, wired 1248	TC-TR348S
	1183396	Dual 310 to Single 310	TC-352
	1164914	Dual 310 to 5-pin Protector	TC-5P350NB

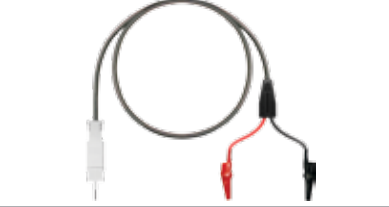

310 Cords

	MC #	Description	Part #
	1164663	310 to 360 Tools 8' Cord	TC-372
	1164662	310 to RJ45 8' Cord	TC-348
	1064179	310 to Minigrabbers 8' Cord	TC-340
	1164661	Cord 310 to LHTCABP 8' Bed of Nails	TC-360- HTCABP/8FT
	1183394	310 to Pin Plugs 8'	TC-380



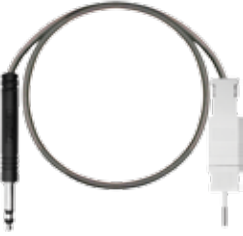

Porta Cords

	MC #	Description	Part #
	1183400	Porta to Porta Frogging 8' Cord	TC-L8FROG
	1247301	Porta to Porta Frogging 16' Cord	TC-L8FROG/16
	1164955	Porta Good Shoe/ Bad Shoe w/ Protection 8' Cord	TC-W111-P-L8/8
	1164954	Porta Good Shoe/ Bad Shoe w/ Protection 25' Cord	TC-W111-P-L8/25
	1164750	Porta to Bantam 8' Cord	TC-L8200
	1164916	Porta to Dual Bantam 16' Cord	TC-L8250/16
	1164936	Cord L8-Y to Alligator Clips 8F	TC-L8600
	1183398	Porta to Porta Looping 8' Cord	TC-L8LOOP/8
	1183399	Porta to Porta Looping 8' Cord	TC-L8LOOP/16



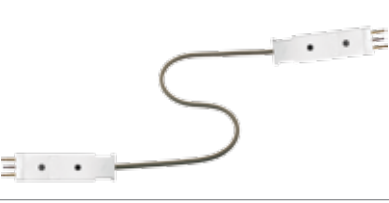

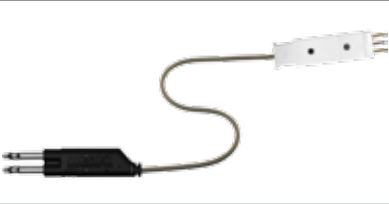

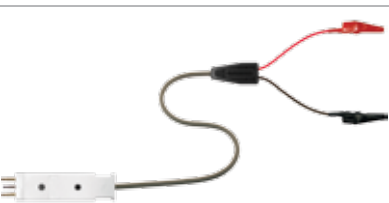

Porta Cords

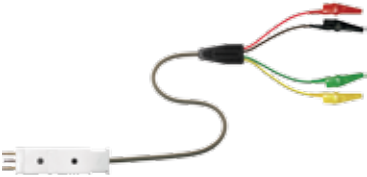
	MC #	Description	Part #
	1164953	Cord Porta Dual Push Pins to Alligator	TC-P2LX
	1164956	Cord Porta Shorting Tool	TC-P2LXST
	1183389	Single Porta to (2) Single Bantam	TC-L8TR200
	1183390	Single Porta to Single Bantam Looking Out	TC-L8310NB/16

463A Cords

	MC #	Description	Part #
	1164671	463A to 463A Frogging 8' Cord	TC-5PFR0G
	1164672	463A to 463A Looping 8' Cord	TC-5PLOOP
	1164732	463A to Bantam Looking In 8' Cord	TC-5P200B
	1164621	463A to Bantam Looking Out 8' Cord	TC-5P200
	1164920	463A to Dual Bantam 8' Cord	TC-5P250
	1164680	463A to 310 Looking In 8' Cord	TC-5P310B
	1164679	463A to 310 Looking Out 8' Cord	TC-5P310
	1239854	2' Cord	TC-5P600/2
	1239855	6' Cord	TC-5P600/6
	1049744	8' Cord	TC-5P600/8
	1050035	16' Cord	TC-5P600/16
			463A to Alligator Clips

463A Cords





	MC #	Description	Part #
	1183438	463A to 4 Alligator Clips 16' Cord	TC-5P600(4)
	1346193	463A to 4 Alligator Clips 3' Cord	TC-5P600(4)/3
	1164753	463A to "Y" Bantam 8' Cord	TC-5PTR200
	1164994	463A Good Shoe/ Bad Shoe w/ Protection 8' Cord	TC-W111-1P/8
	1164993	463A Good Shoe/ Bad Shoe w/ Protection 25' Cord	TC-W111-1P/25
	1164967	463A (ring) Resistance Bridge 8' Red Cord	TC-161774
	1183422	463A (tip) Resistance Bridge 8' Red Cord	TC-161777
	1164677	RJ11 K-Plug to 463A 10' Cord	TC-46311K

Ph: 800.526.2673









Fax: 800.526.3299

www.westek.com

463A Cords

	MC #	Description	Part #
	1164674	Cord 463A NE Wired to Short Pins Looking In Blue	D1250118TX 10
	1164673	Cord 463A NE Wired to Short Pins Looking In Red	D1250118RX 10
	1183422	Cord Resistance Bridge Strap Tip 463A	TC-161777
	1164678	Cord 463A-310-8' No Ground Pin	TC-5P310NP
	1164682	Cord 463A-RJ45-8' Looking In	TC-16326/8

Coax Cords







	MC #	Description	Part #
	1164669	440A to 440A 8' Red Cord	TC-440ARX
	1164670	440A to 440A 8' Blue Cord	TC-440ATX
	1236739	440A to 440A 12' Blue Cord	TC-440ATX/12
	1109725	358A to 440A 8' Cord	TC-458A
	1164829	358A to 440A 10' Cord	TC-458A/10
	1109707 1125409 1183443	440A to 440A 1' Cord 8' Cord 10' Cord	TC-440A/1 TC-440A TC-440A/10
	1183392	310 to BNC	TC-320
	1164828 1164827 1109724	DSX3 358 to 358	TC-358/1 TC-358/10 TC-358A

Ph: 800.526.2673

Fax: 800.526.3299

www.westek.com

Coax Cords

	MC #	Description	Part #
	1109725	358A to 440A 8' Cord	TC-458A
	1164829	358A to 440A 10' Cord	TC-458A/10
	1109707	BNC to 440A 1' Cord	TC-440A-1
	1183443	BNC to 440A 10' Cord	TC-440A-10
	1128130	BNC to BNC	BNC to BNC
	1164764	6' Red Cord 8' Red Cord	TC-500RX/6 TC-500RX
	1341074	BNC to BNC Receive (RG59) 25' Red Cord	TC-500RX/25
	1128160	BNC to BNC	BNC to BNC
	1164765	6' Blue Cord 8' Blue Cord	TC-500TX/6 TC-500TX
	1341075	BNC to BNC Transmit (RG59) 25' Blue Cord	TC-500TX/25
	1164830	BNC to BNC 8' Cord	TC-500
	1183506	Cord D440D-DLCC LK TBS W/ TR	TC-D652T/5
	1183507	5' Cord	TC-D652T/8
	1164814	8' Cord	TC-D652T/10
	1183505	10' Cord	TC-D652T/12
	1251529	12' Cord	TC-D652T/15
	1164815	15' Cord	TC-D652T/20
	1183428	20' Cord	TC-D652T/30
	1183427	30' Cord	TC-D652T/40
		40' Cord	

Coax Cords



	MC #	Description	Part #
DTNC-DTNC	1164908	3' Cord	TC-DTNCT/3
	1164909	4' Cord	TC-DTNCT/4
	1164910	5' Cord	TC-DTNCT/5
	1164911	6' Cord	TC-DTNCT/6
	1183523	7' Cord	TC-DTNCT/7
	1164912	8' Cord	TC-DTNCT/8
	1183524	9' Cord	TC-DTNCT/9
	1164901	10' Cord	TC-DTNCT/10
	1164902	12' Cord	TC-DTNCT/12
	1164903	14' Cord	TC-DTNCT/14
	1164904	16' Cord	TC-DTNCT/16
	1183509	18' Cord	TC-DTNCT/18
	1164905	20' Cord	TC-DTNCT/20
	1183510	22' Cord	TC-DTNCT/22
	1183511	24' Cord	TC-DTNCT/24
	1164906	26' Cord	TC-DTNCT/26
	1183512	28' Cord	TC-DTNCT/28
	1164907	30' Cord	TC-DTNCT/30
	1183513	32' Cord	TC-DTNCT/32
	1183514	34' Cord	TC-DTNCT/34
	1183515	36' Cord	TC-DTNCT/36
	1183516	38' Cord	TC-DTNCT/38
	1183517	40' Cord	TC-DTNCT/40
1183518	42' Cord	TC-DTNCT/42	
1183519	44' Cord	TC-DTNCT/44	
1183520	46' Cord	TC-DTNCT/46	
1183521	48' Cord	TC-DTNCT/48	
1183522	50' Cord	TC-DTNCT/50	

Ph: 800.526.2673





Fax: 800.526.3299

www.westek.com



Coax Cords

	MC #	Description	Part #
	1164899	LCC to LCC with Tracer	TC-LCCT/8
	1164894		TC-LCCT/10
	1164895		TC-LCCT/12
	1164896		TC-LCCT/14
	1164938		TC-LCCT/16
	1164897		TC-LCCT/18
	1251532		TC-LCCT/20
	1183410		TC-LCCT/22
	1164898		TC-LCCT/24
			1183444
1164836		2' Cord	TC-D500T/2
1164840		3' Cord	TC-D500T/3
1109699		4' Cord	TC-D500T/4
1164850		5' Cord	TC-D500T/5
1109720		6' Cord	TC-D500T/6
1164852		7' Cord	TC-D500T/7
1109700		8' Cord	TC-D500T/8
1165002		9' Cord	TC-D500T/9
1105167		10' Cord	TC-D500T/10
1109721		12' Cord	TC-D500T/12
1164835		14' Cord	TC-D500T/14
1105168		16' Cord	TC-D500T/16
1109722		18' Cord	TC-D500T/18
1103956		20' Cord	TC-D500T/20
1164837		22' Cord	TC-D500T/22
1164838		24' Cord	TC-D500T/24
1164839		28' Cord	TC-D500T/28
1164841		30' Cord	TC-D500T/30
1105170		32' Cord	TC-D500T/32
1164842		34' Cord	TC-D500T/34
1164843		36' Cord	TC-D500T/36
1164844		38' Cord	TC-D500T/38
1164845		40' Cord	TC-D500T/40
1164846		42' Cord	TC-D500T/42
1164847		44' Cord	TC-D500T/44
1164848		46' Cord	TC-D500T/46
1164849		48' Cord	TC-D500T/48
1164851		50' Cord	TC-D500T/50
1183439		52' Cord	TC-D500T/52



Coax Cords

	MC #	Description	Part #
	1164900 1125455 1164951 1183534	LCP to LCP 1' Cord 8' Cord 20' Cord 45' Cord	TC-LCP/1 TC-LCP TC-LCP/20 TC-LCP/45
	1123482 1164668 1164981 1252232	LCP to 440A 8' Cord 12' Cord 20' Cord 30' Cord	TC-445 TC-445/12 TC-445/20 TC-445/30
	1127732 1164830	BNC to BNC 6' Cord 8' Cord	TC-500/6 TC-500
	1251526 1109701	BNC to BNC with Tracer 8' Cord 10' Cord	TC-500T TC-500T/10
	1165016	BNC to 358A 10' Cord	TC-558/10

Coax Cords

	MC #	Description	Part #
		BNC to LCP	
	1128131	4' Cord	TC-5324
	1127731	6' Cord	TC-532/6
	1126563	8' Cord	TC-532/8
	1164766	10' Cord	TC-532/10
	1164982	20' Cord	TC-532/20
		Dual LCC to Dual LCC with Tracer	
	1164876	2' Cord	TC-DLCCT/2
	1164882	3' Cord	TC-DLCCT/3
	1164887	4' Cord	TC-DLCCT/4
	1164892	5' Cord	TC-DLCCT/5
	1164869	6' Cord	TC-DLCCT/6
	1164893	7' Cord	TC-DLCCT/7
	1164870	8' Cord	TC-DLCCT/8
	1164871	10' Cord	TC-DLCCT/10
	1164872	12' Cord	TC-DLCCT/12
	1164873	14' Cord	TC-DLCCT/14
	1164874	16' Cord	TC-DLCCT/16
	1164875	18' Cord	TC-DLCCT/18
	1164877	20' Cord	TC-DLCCT/20
	1164928	22' Cord	TC-DLCCT/22
	1164878	24' Cord	TC-DLCCT/24
	1164879	25' Cord	TC-DLCCT/25
	1164880	26' Cord	TC-DLCCT/26
	1164881	28' Cord	TC-DLCCT/28
	1164883	32' Cord	TC-DLCCT/32
	1164884	34' Cord	TC-DLCCT/34
	1164885	36' Cord	TC-DLCCT/36
	1164886	38' Cord	TC-DLCCT/38
	1164888	40' Cord	TC-DLCCT/40
	1164889	42' Cord	TC-DLCCT/42
	1164890	44' Cord	TC-DLCCT/44
	1251531	46' Cord	TC-DLCCT/46
	1164891	48' Cord	TC-DLCCT/48
1183508	50' Cord	TC-DLCCT/50	

Coax Cords



	MC #	Description	Part #
	1164856 1164860 1164927 1164864 1164866 1164867 1164868 1105171 1164853 1164854 1164926 1164855 1164857 1183411 1164858 1164859 1183477 1164861 1183478 1183479 1164862 1183480 1164863 1183481 1183482 1183483 1183484 1164865	Dual BNC to Dual LCC with Tracer 2' Cord 3' Cord 4' Cord 5' Cord 6' Cord 7' Cord 8' Cord 10' Cord 12' Cord 14' Cord 16' Cord 18' Cord 20' Cord 22' Cord 24' Cord 26' Cord 28' Cord 30' Cord 32' Cord 34' Cord 36' Cord 38' Cord 40' Cord 42' Cord 44' Cord 46' Cord 48' Cord 50' Cord	TC-D531T/2 TC-D531T/3 TC-D531T/4 TC-D531T/5 TC-D531T/6 TC-D531T/7 TC-D531T/8 TC-D531T/10 TC-D531T/12 TC-D531T/14 TC-D531T/16 TC-D531T/18 TC-D531T/20 TC-D531T/22 TC-D531T/24 TC-D531T/26 TC-D531T/28 TC-D531T/30 TC-D531T/32 TC-D531T/34 TC-D531T/36 TC-D531T/38 TC-D531T/40 TC-D531T/42 TC-D531T/44 TC-D531T/46 TC-D531T/48 TC-D531T/50
	1096311 1096313 1096314 1164831 1164832 1164833 1164834 1183407 1196010 1183408 1183409 1183470 1183471 1183472	Dual 440 to Dual 440 with Tracer 4' Cord 6' Cord 8' Cord 10' Cord 12' Cord 14' Cord 16' Cord 18' Cord 20' Cord 22' Cord 24' Cord 26' Cord 28' Cord 30' Cord	TC-D452T/4 TC-D452T/6 TC-D452T/8 TC-D452T/10 TC-D452T/12 TC-D452T/14 TC-D452T/16 TC-D452T/18 TC-D452T/20 TC-D452T/22 TC-D452T/24 TC-D452T/26 TC-D452T/28 TC-D452T/30

Ph: 800.526.2673

Fax: 800.526.3299

www.westek.com





Coax Cords

	MC #	Description	Part #
	1183473 1183429 1183434 1113118 1183475 1183433 1183432 1183431 1183476	Dual 440 to Dual 440 with Tracer 32' Cord 36' Cord 38' Cord 40' Cord 42' Cord 45' Cord 48' Cord 50' Cord 52' Cord	TC-D452T/32 TC-D452T/36 TC-D452T/38 TC-D452T/40 TC-D452T/42 TC-D452T/45 TC-D452T/48 TC-D452T/50 TC-D452T/52
	1183492 1183497 1164824 1164825 1183503 1183485 1183504 1183528 1183485 1164821 1183486 1183487 1183488 1183489 1183490 1183491 1183493 1164822 1183494 1183495 1183496 1183498 1183499 1183500 1183501 1183502 1164823	DTNC-DBNC W/ TRACER 3' Cord 4' Cord 5' Cord 6' Cord 7' Cord 8' Cord 9' Cord 12' Cord 14' Cord 16' Cord 18' Cord 20' Cord 22' Cord 24' Cord 26' Cord 28' Cord 30' Cord 32' Cord 34' Cord 36' Cord 38' Cord 40' Cord 42' Cord 44' Cord 46' Cord 48' Cord 50' Cord	TC-D543T/3 TC-D543T/4 TC-D543T/5 TC-D543T/6 TC-D543T/7 TC-D543T/8 TC-D543T/9 TC-D543T/12 TC-D543T/14 TC-D543T/16 TC-D543T/18 TC-D543T/20 TC-D543T/22 TC-D543T/24 TC-D543T/26 TC-D543T/28 TC-D543T/30 TC-D543T/32 TC-D543T/34 TC-D543T/36 TC-D543T/38 TC-D543T/40 TC-D543T/42 TC-D543T/44 TC-D543T/46 TC-D543T/48 TC-D543T/50

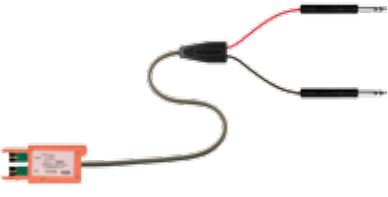
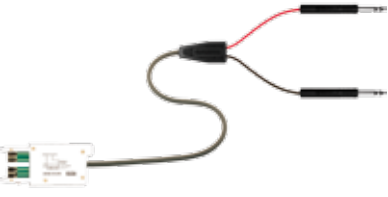

Coax Cords

	MC #	Description	Part #
		Dual TNC to Dual LCC W/TRCR	
	1183459	4' Cord	D3-26002/4
	1183465	5' Cord	D3-26002/5
	1183467	6' Cord	D3-26002/6
	1183468	7' Cord	D3-26002/7
	1183469	8' Cord	D3-26002/8
	1183445	10' Cord	D3-26002/10
	1183446	12' Cord	D3-26002/12
	1183447	14' Cord	D3-26002/14
	1183448	16' Cord	D3-26002/16
	1183449	18' Cord	D3-26002/18
	1183450	20' Cord	D3-26002/20
	1183451	22' Cord	D3-26002/22
	1183452	24' Cord	D3-26002/24
	1183453	26' Cord	D3-26002/26
	1183454	28' Cord	D3-26002/28
	1183455	30' Cord	D3-26002/30
	1183456	32' Cord	D3-26002/32
	1183457	34' Cord	D3-26002/34
	1251513	36' Cord	D3-26002/36
1183458	38' Cord	D3-26002/38	
1183460	40' Cord	D3-26002/40	
1183461	42' Cord	D3-26002/42	
1183462	44' Cord	D3-26002/44	
1183458	46' Cord	D3-26002/46	
1183464	48' Cord	D3-26002/48	
1183466	50' Cord	D3-26002/50	





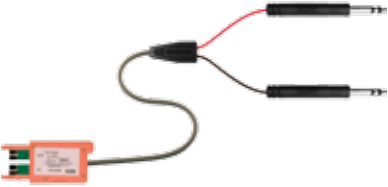
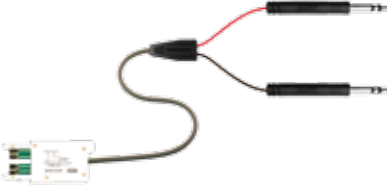
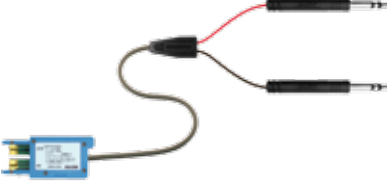

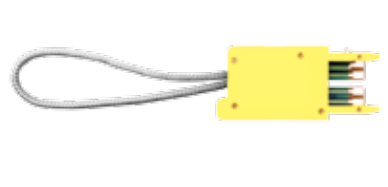
800 DSX Cords

	MC #	Description	Part #
	1164694	800 Simplex to 800 Simplex 6' Cord	TC-800/6
	1109705	800 Simplex to 800 Simplex 12' Cord	TC-800/12
	1247301	800 Duplex to 800 Duplex 6' Cord	TC-850/6
	1164687	800 Duplex to 800 Duplex 12' Cord	TC-850/12
	1109706	800 Simplex to Bantam	TC-820/6
	1164695	6' Cord	TC-820/12
	1183537	12' Cord	TC-820/20
	1183538	20' Cord	TC-820/30
	1164691	800 Duplex Orange to Y Bantam 12' Cord Monitors	TC-8230
	1164692	800 Duplex White to Y Bantam 12' Cord Near Connect Far Disconnect	TC-823W
	1164690	800 Duplex Blue to Y Bantam 12' Cord Far Connect Near Disconnect	TC-823B





800 DSX Cords

	MC #	Description	Part #
	1183401	800 Duplex Orange to Y 310 12' Cord Monitors	TC-8330
	1164686	800 Duplex White to Y 310 12' Cord Near Connect Far Disconnect	TC-833W
	1183402	800 Duplex Blue to Y 310 12' Cord Far Connect Near Disconnect	TC-833B
	1164693	800 Simplex to 310 12' Cord	TC-830/12
	1123404	800 Duplex Yellow Looping Plug	TC-LP800

AT&T Replacement Cords

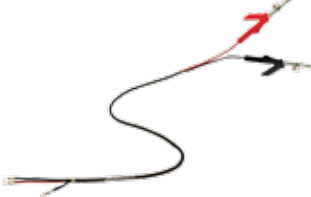
	MC #	Description	Part #
	1044679	453A to Alligator Clips 16" Red/Black Cord	TC-P2EF
	1044440	L5 to Alligator Clips 16" Red/Black Cord	TC-P2FM
	1031293	526A to Alligator Clips 16" Red/Black Cord	TC-P2FL
	1164975	RJ48 to RJ48 10' Royal Blue Cord	TC-140
	1251521	310 to 360 Tools 6' Cord	TC-2W17A
	1164654	471A to Alligator Clips 4' 5" Cord	TC-2W37A

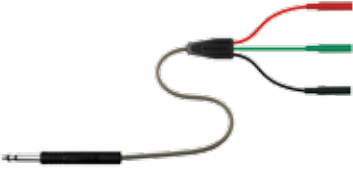
AT&T Replacement Cords





	MC #	Description	Part #
	1049337	Minigrabber to Minigrabber 6' Cord	TC-700
	1164653	Hardwire Lugs to Heavy Test Clip 5' Cord	TC-H2B
	1107181	Hardwire Lugs to Quick Disconnect 346A 16" Cord	TC-H2C
	1251524	310 to 360 Tools 6' Cord	TC-3W4A
	1164968	RJ11 to Alligator Clips 5' Cord	TC-611/5
	1164950	Alligator Clips to Pair of TC-607/16IN	TC-607/16IN

Ph: 800.526.2673



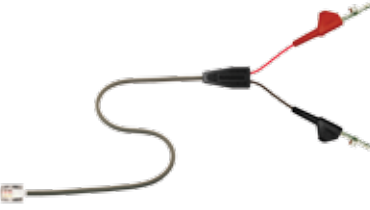



Fax: 800.526.3299

www.westek.com

AT&T Replacement Cords

	MC #	Description	Part #
	1044869	Castle to 526A and 463A 16" Cord	TC-6W3E
	1164983	Throwmaster Cord Wired 4' and 5' to RJ11 to Heavy Test Clip with bed of nails and pin	TC-16061/5
	1030420	SLC5 to Alligator Clips 16" Cord	TC-SLC5
	1024772	Quick Disconnect 471A to 310 4' Cord	TC-SC371
	1164984	SLC 96 to Alligator Clips 16" Cord	TC-SLC96

AT&T Replacement Cords



	MC #	Description	Part #
	1164991	5 amp Clip to Hardwire Lugs 6' Cord	TC-W1AH
	1045125	20 amp Clip to 20 amp Clip Coiled Cord 25' stretched	TC-W1BU
	1164992	463A to Alligator clips with Red & White #26 Boots 4.5' Cord	TC-W2GL
	1034081	463A without ground pin to Alligator Clips 16" Cord	TC-W463EF
	1164996	463A to 327 Plug 16' Gray Cord	TC-W4CJ
	1164950	Alligator Clips to Pair of TC-607/16IN	TC-607/16IN

Ph: 800.526.2673

Fax: 800.526.3299

www.westek.com

AT&T Replacement Cords

	MC #	Description	Part #
	1164995	Dual Bantam (2 Conductor) to 463A 16' Cord	TC-W4CT
	1034286	463A to 125BW 16' Cord	TC-W4DG
	1183404	471A Plug to Bantam	TC-SC370

300 Series Module Cleaner/Tester

Adapter Installation and Removal Tool







MC# 1165027
TC-AD300



PRODUCT HIGHLIGHTS

- The 300 Cleaner/Tester adapter plugs into any standard wall mounted test and clean unit found in the Center Office.
- Potentially re-use modules and save money by testing 300 style protector modules.

Modular Cords







	MC #	Description	Part #
	1164975	RJ48 to RJ48 10' Royal Blue Cord	TC-140
	1164817	15 pin Male to RJ48 8' Cord	TC-15MRJ48
	1066863 1164754	RJ48 to Y Bantam wired 1245 8' Cord 10' Cord	TC-TR248C TC-TR248C/10
	1112309	RJ48 to Y Bantam wired 1278 8' Cord	TC-TR248S
	1164971	RJ48 to Alligator Clips 8' Cord	TC-2PL1
	1120196	Bantam to Modular RJ48 8' Cord	TC-248

Ph: 800.526.2673

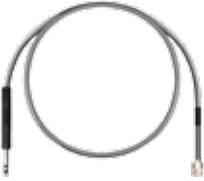
Fax: 800.526.3299

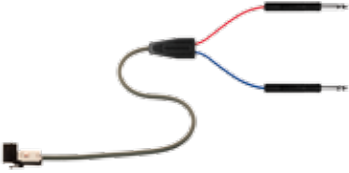
www.westek.com



Modular Cords

	MC #	Description	Part #
	1183379	Bantam to Modular RJ22	TC-222
	1164749	Bantam to Modular RJ11	TC-211
	1164969	Female RJ45 to Y Bantam 8" Cord	TC 16118
	1164973	Cord RJ45-Y 6ft Standard Version 8 Pin to 2 Clip Leads	D1 250106/6
	1164697	Cord 8 Pin Modular to 2 Clip Leads	D1 250106/8
	1164924	RJ48 to Single Bantam Wired 7,8	TC-248S

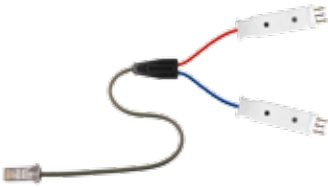
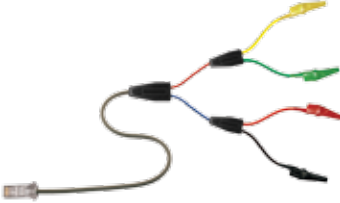
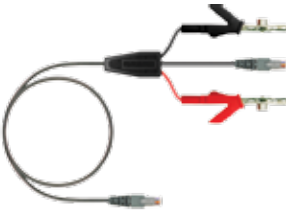
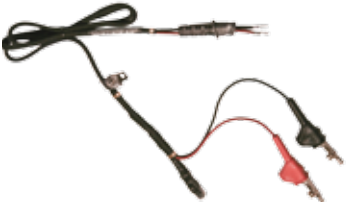
Modular Cords

	MC #	Description	Part #
	1164943	RJ48 to Y 463A TX & RX 16' Cord	TC-L4RJ48
	1164944	RJ48 to Porta TX and Porta RX	TC-L8RJ48
	1164942	RJ48 to Y 4 Alligators 16' Cord	TC-L1RJ48
	1165020	RJ45 to Heavy Test Clip w/ RJ11 to plug direct to wall jacks, or residential Network Interface	TC-6003
	1164988	Hardwires to TS-44+ TS-52 Buttset w/ RJ11 to plug direct to wall jacks, or residential Network Interface	TC-162202



Modular Cords

	MC #	Description	Part #
	1247702	Right Angle RJ45 to RJ45 3'	TC-153433/3
	1164757	BMOD6-C2-L1-L4/10 Look In	TC-MD6214/10IN
	1219724 1219725	New Patented Replacement Cables for Six Position Banjo 3" Cord 6" Cord	KT-5PKRJ11LE/3 KT-5PKRJ11LE/6



Right Angle
RJ45
TC-153433/3
see above

Modular Cords

	MC #	Description	Part #
	1269687	Sidekick Replacement Cord for Greenlee Sidekick 3 Round Lugs to (2) LHTCAB and #27 Clip	D1 250559/5
	1164718	POTS testing Data testing	TC-BJ100-Pro

Banjo Pro

Three tools in one.

Patent Pending



Save money, time, and space with the three in one convenience of Westek's **Banjo Pro!** Featuring our **Unbreakable Banjo Pro Cable**

- Data Testing - Plug in **Black RJ45** for 8 conductor testing





- POTS Testing - Plug in **Red RJ11** and "Just Flip It" for 2, 4 and 6 conductor testing

Ph: 800.526.2673



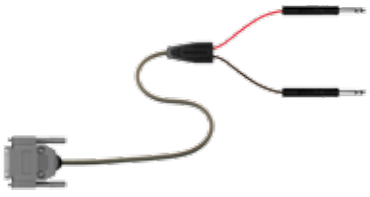

Fax: 800.526.3299

www.westek.com

Data Cords

	MC #	Description	Part #
	1164645 1164639 1183440	25 pin Male to 9 pin Female	TC-25M9F/10 TC-25M9F/50 TC-25M9F/70
	1164816	15 pin Male to 15 pin Female 10' Cord	TC-15M15F/10
	1183418	15 pin Male to 15 pin Male 10' Cord	TC-15M15M
	1164752	15 pin Male to Y Bantam 10' Cord	TC-PC15M200
	1164704 1164941	9 Pin Female to 9 Pin Female 10' Cord 25' Cord	TC-9F9F/10 TC-9F9F/25

Data Cords



	MC #	Description	Part #
	1164940	Cord M 25A 87 50FT (25 pin Male to 25 pin Female 50')	TC-25M25F/50
	1164939	Cord M 25A 87 25FT (25 pin Male to 25 pin Female 25')	TC-25M25F/25
	1164818	Cord M 25A 87 10FT (25 pin Male to 25 pin Female 10')	TC-25M25F/10
	1185098	Cord M 25A 87 24FT (25 pin Male to 25 pin Male 24')	TC-25M25M/24
	1164644	Cord M 25A 87 10FT (25 pin Male to 25 pin Male 10')	TC-25M25M/10
	1164820	Cord 9 Pin female DIN Plug to 8 Pin female DIN plug 10 FT cord	D1250346-10
	1128132 1164706 1123167 1123166 1128133 1164700 1164701 1251582	9 pin Male to 9 pin Female 6' Cord 10' Cord 15' Cord 25' Cord 30' Cord 40' Cord 50' Cord 100' Cord	TC-9M9F/6 TC-9M9F/10 TC-9M9F/15 TC-9M9F/25 TC-9M9F/30 TC-9M9F/40 TC-9M9F/50 TC-9M9F/100
	1164819	8' Cord	TC-9MRJ48

Ph: 800.526.2673

Fax: 800.526.3299

www.westek.com

Data Cords

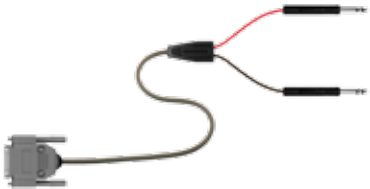
	MC #	Description	Part #
	1164705	9 Pin Male to 15 Pin Male	TC-9M15M\6
	1164643	25 Pin Male to 15 Pin Male	TC-25M15M\6
	1164641	310 Y to 15 pin Female 2' Cord	TC-15F310/2
	1164751	Bantam Y to 15 pin Female 8' Cord	TC-15F200

Can't Find The Cable You're Looking For?



▶ Contact Us!

Westek cable specialists are available Monday through Friday, from 7:00a.m. to 4:00p.m. Pacific Standard Time to assist you with higher quality cables, cost reduction, and engineering support!

800.526.2673

Ph: 800.526.2673

www.westek.com

Fax: 800.526.3299

JDSU Far End Device Kit

For the complete kit (4 cords)

MC#1164935

KT-290558



MC# 1164989

TC 162269

463A to Protector Cradle to
RJ45 L Plug



MC# 1164972

TC 162326

RJ45 L Plug to Red and Black
Wire Wraps, and Ground Alligator
Clip



MC# 1164990
TC 162268
RJ45 L Plug to Y (3) Alligator
Clips



MAT 1164708
TC-600/12
Alligator Clip to Alligator Clip (12')

Combi-Cord Sample Order

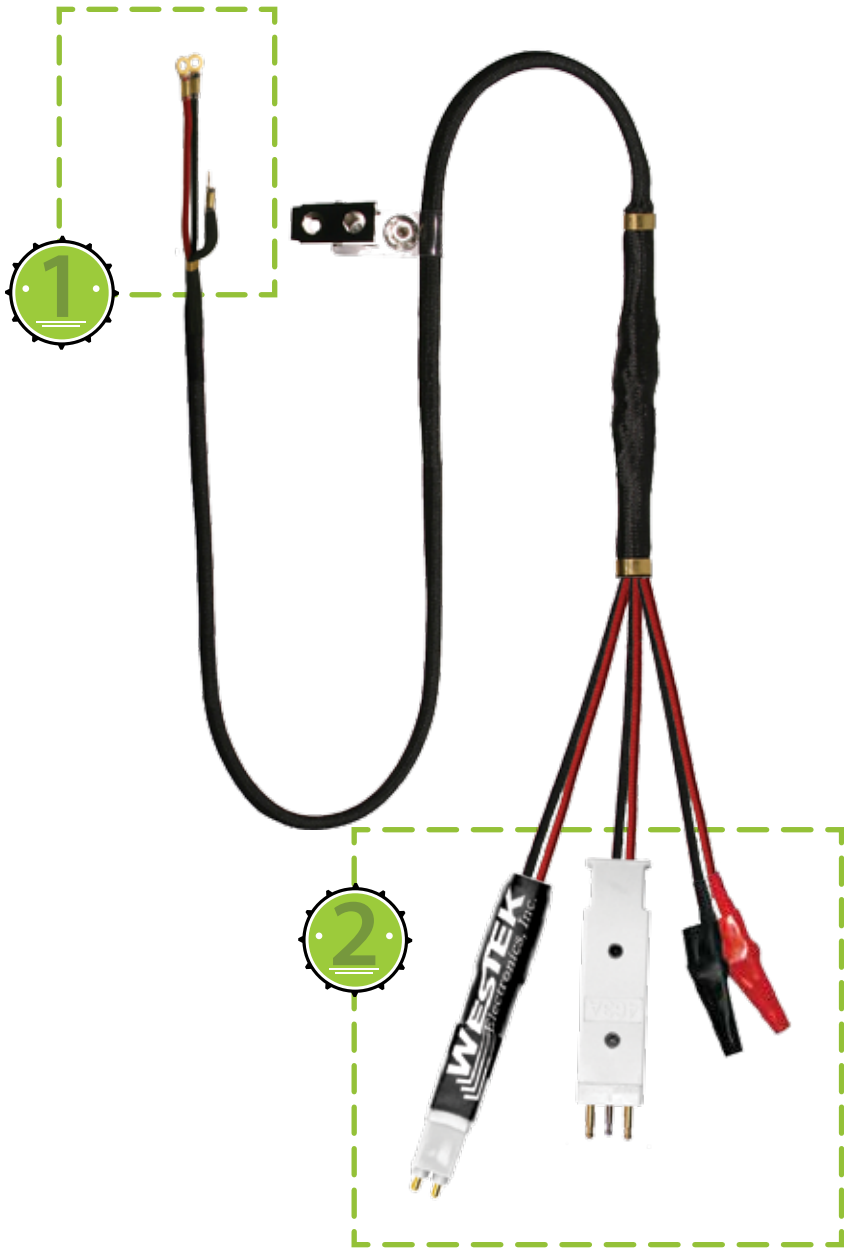



Steps to ordering Combi-Cords:

1

Choose Buttset End Connection

2

Choose Components

(Up to 5 Total)

Combi-Cord Benefits

- Ultra-durable nylon braided jacket guarantees ruggedness and flexibility.
- Junction is constructed using insulated piercing lugs secured by a lock nut with a solder weld.
- Highest quality components made of state of the art materials insure long life and dependability.
- Red/Black nylon braided jacket protects insulated tinsel conductor.
- Combi Clip keeps plugs that are not in use and out of the way.

Ph: 800.526.2673

Fax: 800.526.3299

www.westek.com

Combi-Cord Ends



Choose Buttset End Connection

B1....Hardware (w/Strain Relief)



B3....Hardwire (Round Lugs)



B4....Modular Type, 4 Conductor, RJ22



B6....Modular Type, 6 Conductor, RJ11



B8....Modular Type, 8 Conductor, RJ45 / RJ48



TS22...For Fluke/Harris test sets



TS44/TS52.... For Fluke/Harris test sets



B2.... Quick Disconnect Option (471A QD or WECO Type 471A QD)





Combi-Cord Ends

Choose Components (Up to 5 Total)

LMOD4....Modular Type Plug, 4 Conductor, RJ22



LMOD6....Modular Type Plug, 6 conductor, RJ11



LMOD8....Modular Type, 8 Conductor, RJ45 / RJ48



LO....Miniature alligator clips (Mueller #30); (one pair: red/black)



LS....Step switch space lug



LX....Porta (Plugs into test field)



LBIX....Bix connector (QTBIX17-NT)



LMG....Mini Grabbers (one pair: red/black)



LNAN....Banana Plug



LOE....Northern Telecom Original Equipment



LSLC5....SLC-5 Plug



Ph: 800.526.2673

www.westek.com

Fax: 800.526.3299



Choose Components continued...

310...310 Plug



L3M...3M Binding Post Clip



L4....463A (Replaces 5 Pin Protector)



L4W0....L4 (without ground pin, looks in and out)



L5....P2FM Equivalent (AT&T 310 and 311)



L6....Large Chuck ends (adapter 360 Tool) ; (one pair: red /black)



L7.... Chuck Ends (over wire wrap pins) ; (one pair: red /black)



L8....Porta (replaces protector)



L9....Porta (plugs into protector)



L96....SLC-96 Plug (equivalent to mini-plug)



LDBAN....Dual Bantam Plug



Combi-Cord Ends

L1....Alligator Clips (Mueller #60)



L110....AT&T 110 Connector Plug



L110D....110 D Test Connector



L2....453A or P2EF equivalent (AT&T 303 & 309-NT 377)



L284....Amphenol 284-1 Plug for 66 Block



L299...Plugs into NT 399 Block



L3....526A (Plugs into 4C Type Protector)



LHTCAB...Heavy Test Clips, Angle Nose, Bed of nails ; (one pair: red /black)



LHTCAP....Heavy Test Clip, Angle Nose, Single Pin ; (one pair: red /black)



Ph: 800.526.2673

www.westek.com

Fax: 800.526.3299

Pre-Built Combi-Cords

Components

For Combi-Cord components description:
Reference pictures on previous pages 62-65

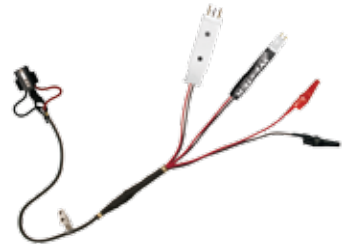

MC #	Description	Part #
1164762	BMOD8 C3 LHTCAPB L4 RJ11 Looking In	TC-161762
1183425	B1 C3 LSLC5 LHTCAB LSLC96	TC-16YQZ
1164962	Quick Disconnect a/ Alligator Clip, B2 C2 L1 L4 463A	TC-2214
1164717	B2 C5 L1 L2 L4 L5 L7	TC-2512457
1164714	B2 C3 L1 L3 L7	TC-23137
1164760	BMOD8 C3 L1 L2 L7	TC-83127
1164761	BMOD8 C3 L1 L4 L7	TC-83147
1164758	BMOD6 C3 L1 L4 L7 Looking In	TC-63147/IN
1164682	463A-RJ45-8ft Looking In	TC-16326
1164716	B2 C5 L1 L2 L3 L5 L7	TC-2512357
1164783	B2, C3, L1, L2, L4	TC-23124
1251516	B2, C3, L1, L2, LX	TC-2312X
1034206	B2, C4, L1, L2, L3, L7	TC-241237
1164780	B2, C2, L1, L2	TC-2212
1164781	B2, C2, L1, L5	TC-2215
1164782	B2, C3, L1, L2, L3	TC-23123
1164785	B2, B3, L1, L2, L6	TC-23126
1033622	B2, B3, L1, L2, L7	TC-23127
1164786	B2, C3, L1, L5, L6	TC-23156
1183376	B2, C3, L1, L5, LX	TC-2315X
1164789	B2, C4, L1, L2, L4, L7	TC-241247
1164790	B2, C4, L1, L2, L5, L7	TC-241257
1164775	B1, C3, L1, L2, L6	TC-13126
1347503	B2, C4, L1, L2, L4, L8	TC-241248
1164713	B1, C5, L1, L2, L3, L4, L7	TC-1512347
1183425	B1, C3, LHTCAB, SLC5, SLC96	TC-13QYZ
1183527	BMOD6, C3, L1, L2, L7	TC-63127
1164715	B1,C4,L1,L2,L7, LHTCABP	TC-14127R
1164759	BMOD8, C2, L1, L7	TC-8217

Pre-Built Combi-Cords *cont.*

MC #	Description	Part #
1164715	B2, C4, L1, L2,L7, LHTCABP	TC-24127R
1164763	BMOD8,C4,L1, L2,L4, L7	TC-841427
1164784	B2,C3,L1,L2,L5	TC-23125
1164629	B2,C3,L1,L5,L7	TC-23157
1164633	B2,C4,L1,L2,L3,L5LC5	TC -24123Y
1164630	B2,C4,L1,L4,L5,L7	TC-241457
1164632	B2,C5,L1,L2,L4,L5,L6	TC-2512456
1164797	B2, C6, L1 ,L2, L3, L4, L5, L7	TC-26123457
1164638	BMOD4, C4, L1, L2, L4, L7	TC-441247
1164622	BMOD6, C2, L1, L4	TC-6214
1183526	BMOD6, C3, L1, L2, L4	TC-63124
1164804	BMOD6, C3, L1, L4, L8	TC-63148
1164636	BMOD6, C5, L1, L2, L4, L5, L7	TC-6512457/IN
1164805	MOD8, C2, L1, L4 Looking In	TC-8214/IN
1050038	B2, C1, L7	TC-217
1164756	BMOD6, B2, C1, L7	TC-6217
1051320	BL1 C1 L7	TC BL117
1164811	B1 C1 L3M	TC 11F
1164773	B1 C1 LBAN	TC 11K
1103954	B1 C2 L1 L7	TC 1217
1164774	B1 C2 L1 L7	TC 1217
1034071	B1 C3 L1 L2 L7	TC 13127
1164628	B1 C3 L1 L4 L7	TC 13147
1164776	B1 C3 L1 L4 (Look In) L7	TC 13147 Look In
1185170	B1 C3 L1 L7 L8	TC 13178
1164777	B1 C3 L1 L7 L8-Look In	TC 13178 Look In
1117262	B1 C3 L2 L5 LHTCABP	TC 1325R
1117309	B1 C3 L2 L284 LMOD4	TC 132CMOD4
1103952	B1 C4 L1 L2 L4 L7	TC 141247
1113195	B1 C4L1L2 L5 L7	TC 141257
1164712	B1 C4 L1 L2 L7 LHTCABP	TC 14127R
1103958	B1,C4,L7,L2,L1,LMG	TC 14127T
1164779	B1 C4 L1 L7 L4 (Look In) L8 (Look In)	TC 141478/IN
1164778	B1 C4 L1 L5 L7 LX	TC 14157X

Ph: 800.526.2673

Fax: 800.526.3299

www.westek.com

Pre-Built Combi-Cords *cont.*

MC #	Description	Part #
1164983	Throwmaster Talk Cord RJ11(4,5)-LHTCABP's 5FT	TC 16061/5
1119611	B1-TS44 C3 L1 L2 L7 4FT 6IN	TC 161744
1164769	(2)Lugs TS44-346A	TC 161753
1164988	TS44 TO LHTCABP RJ11 L PLUG E	TC 162202
1048134	B2 C1 L1	TC 211
1049413	B2 C1 LHTCABP	TC 21R
1164787	B2 C3 L1 L7 L4W0	TC 2317J
1164767	B2 C3 L1 L7 LX	TC 2317X
1164634	B2 C3 L1 L8 LX	TC 2318X
1164788	B2 C4 L1 L2 L3 L4	TC 241234
1109728	B2 C4 L1 L2 L4 L7	TC 241247
1183435	B2 C4 L1 L2 L6 L7	TC 241267
1109704	B2 C4 L1 L2 L7 LMOD4	TC 24127MOD4
1106301	B2 C4 L1 L2 L7 LMG	TC 24127T
1237453	B2 C4 L1 L2 L7 L96	TC 24127Z
1205428	B2 C4 L1 L2 L3M LSLC5	TC 2412FY
1183532	B2 C4 L1 L2 L4W/0 LSLC5	TC 2412JY
1183531	B2 C4 L1 L3 SLC96 SLC5	TC 2413YZ
1205429	B2 C4 L1 L5 L6 L7	TC 241567
1183529	B2 C4 L1 L110D L4W/0 L7	TC 2417BJ
1164631	B2 C4 L2 L4 L5 L7	TC 242457
1164716	B2 C5 L1 L2 L3 L5 L7	TC 2512357
1164791	B2 C5 L1 L2 L3 L7 LSLC5	TC 251237Y
1164792	B2 C5 L1 L2 L4 L8 LX	TC 251248X
1164794	B2 C5 L1 L2 L5 L7 LX	TC 251257X
1164793	B2 C5 L1 L2 L4WITH 0 L7 LSLC5	TC 25127JY
1164795	B2 C5 L1 L7 L4WITH 0 L110D LSLC5	TC 2517BJY
1164798	B2 C6 L1 L2 L4 L7 L8 LX	TC 2612478X
1165012	B2 C7 L1 L2 L3 L5 L7 LMG LSLC5	TC 2712357TY
1167863	B3 C4 L7 L284 LHTCAB MOD6	TC 347CQMOD6
1087756	B4 C1 L7	TC 417
1183526	BMOD6 C3 L1 L5 L7	TC 63157
1164801	B6 C4 L1 L7 L4 (LOOK IN) L8 (LOOK IN)	TC 641478/IN
1164623	BMOD8 C1 L4 LOOKING IN	TC 814/IN

Pre-Built Combi-Cords *cont.*

MC #	Description	Part #
1164810	BMOD8 C1 L7	TC 817
1106609	BMOD8 C2 L1 L7 7FT	TC 8217/7
1265322	BMOD8-C3-L1-L2-L4IN	TC 83124IN
1183436	BOOD8 C4 L1 L2 L4 L7 6FT	TC 841247/6
1221544	BBAN-C4-L1-L7-LBAN-LMG	TC K417KT
1102897	BLHTCAB C4 L2 L4 L7 L284	TC Q4247C
1164772	B1 (TS44) C4 L1 L2 L5 L7	TC TS441257
1343577	TS44, C4, L2, L4, L7, LHTCAB	TC TS44247Q
1164809	TS44(B1) C3 L1 L7 LX	TC TS44317X
1239845	TS44-C3-L2-L7-LHTCAB	TC TS44327Q
1116177	TS44 C4 L1 L2 L5 L7	TC TS4441257
1164808	TS44 B1 C4 L1 L4 LOOK IN L7 L8 Look In	TC TS4441478/IN
1165844	TS44- L3 LHTCAB LSLC5 & LSLC96	TC TS4443QYZ
1188919	TS44 C5 L3 L4 LHTCAB LSLC5 LSLC96	TC TS44534QYZ
1329592	TS44, C4, L284, L3M, LHTCAB, LMOD6	TC TS44CFQMOD6
1345226	B2 C3 L1 L2 L4W0	TC 23124W0
1329707	B2 C5 L1 L2 L4W0 LHTCAB LMG	TC 25124WOTQ
1183536	B8 TO 463A/L1 Looking In 10FT	TC-8214IN/10

Components

*For Combi-Cord
components description:*
Reference pictures on
previous pages 62-65

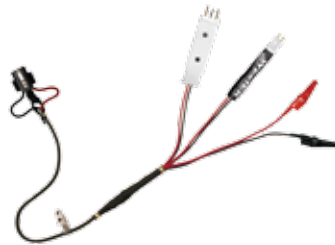

Looping Plugs, Terminators & Adapters

	MC #	Description	Part #
	1123352	P2EF Shorting Tool	TC-P2EFST
	1164974	RJ48 T1 Shorting Plug	TC-LPRJ48C
	1044887	Dual Bantam Looping Plug	TC-LP250
	1238478	Dual 310 Looping Plug	TC-LP350
	1164976	463A Shorting Tool Red	TC-161768
	1165008	463A Shorting Tool Black	TC-161771
	1164722 1164723 1183403	Bantam Terminating Plug 135 Ohms 600 Ohms 900 Ohms	TC-TP201 TC-TP206 TC-TP209
	1164957	Female 463A to Porta 1' Cord	TC-AD303

Looping Plugs, Terminators & Adapters





	MC #	Description	Part #
	1123404	800 Duplex Yellow Looping Plug	TC-LP800
	1164707	310 to Bantam Adapter Blue	TC-AD310B
	1104787	310 to Bantam Adapter Red	TC-AD310R
	1188914	Female 463A to 463A 30" Cord	TC-L4PEXT/30
	1119368	440A to BNC Adapter	TC-AD440
	1109726	358A to BNC Adapter	TC-AD358
	1106614	BNC Coupler	TC-BNCCPLR
	1164702	9 pin Female to 9 pin Female Low Profile Gender Changer	TC-GCPC9F
	1164703	9 pin Male to 9 pin Male Low Profile Gender Changer	TC-GC9M

Ph: 800.526.2673



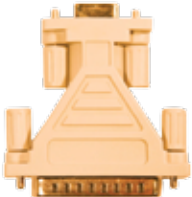
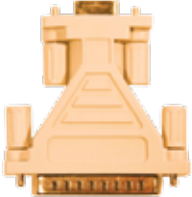

Fax: 800.526.3299

www.westek.com





Looping Plugs, Terminators & Adapters

	MC #	Description	Part #
	1164699	9 pin Male to 9 pin Female Low Profile Null Modem	TC-NM900LP
	1164650	25 pin Female to 25 pin Female Low Profile Gender Changer	TC-GCPC25F
	1164651	25 pin Male to 25 pin Male Low Profile Gender Changer	TC-GCPC25M
	1164646	25 pin Male to 25 pin Female Low Profile Null Modem	TC-NM100LP
	1164620	DB25M to DB9F	TC-AD25M9F
	1164619	DB9M to DB25F	TC-AD9M25F

T-Berd Test Cords

	MC #	Description	Part #
	1164771	310 to 463A, Alligator Clips and holstered Bantam 15' Blue Cord	TCC-323 TX
	1164770	310 to 463A, Alligator Clips and holstered Bantam 15' Red Cord	TCC-323 RX
	1164813	Bantam to 463A, Alligator Clips and holstered Bantam 15' Blue Cord	TCC-232 TX
	1164812	Bantam to 463A, Alligator Clips and holstered Bantam 15' Red Cord	TCC-232 RX
	1183441	14 Pin Bayonet Lkplg- 15(m) 10' Cord	DC-260047/10



Testers

	MC #	Description	Part #
	1165025	TEST SET TEL-LINE TESTER PRO™ KIT INCLUDES LOOPING TOOL AND GROUNDING TOOL	KT-291052
	1109708	Tel-Line Tester™ Kit	TC-TLTS-2
	1030516	Tel-Line Tester™ Kit with Bag	TC-TLTS2C
	1164979	CORD TEL-LINE TESTER™	TC-TLTS-G



Testers

	MC #	Description	Part #
	1185004	Accessory Kit for Tel-Line Tester™	KT 290407
	1164980	Tel-Line Tester™ only	TC-TLTS 1A
	1165026	Porta Tel-Line Tester™	TC-TLTS 1P
	1165027	300 Series Cleaner Adapter	TC-AD300
	1164719	Banjo Yellow w RJ45 Lan Cord	TC-BJ100Y

Miscellaneous

	MC #	Description	Part #
	1164977	Small Cord Bag Blue	CB 05190000
	1164937	Large Kit Bag Black	TC-P01
	1183377	ISDN AT&T POWER SUPPLY BRACKET 19IN	TC-ISDN

Tools

	MC #	Description	Part #
	1183423	CORD TESTER ADAPTER CABLE PROTECTOR CRADLE TO MOLDED RJ11	TC-TLTS 4A
	1164711	CORD ANTI STATIC WRIST STRAP 3 WAY 0 OHM GROUND STRAP	TC-WS100
	1183426	FIBER TOOL	FP 360023

CenturyLink Outside Plant



Test right the first time with Westek's pair bonding test cords.



RJ45 to (4) Alligators

Part# TC-153344

MC# 1225210

Pair Bond Testing



RJ45 to (4) L7

Part# TC-153341

MC# 1225209

Pair Bond Testing

★ PAIR BONDING ★



RJ45 to (5) LHTCAB
Part# TC-152896
MC# 1226519
Pair Bond Testing



RJ45 to (2)
463A (L4)

Part# TC-153340
MC# 1225208

Pair Bond Testing

Ph: 800.526.2673

www.westek.com

Fax: 800.526.3299

TEST SET TEL-LINE TESTER PRO KIT™

Troubleshoot Cable Pairs Fast and with Protection.



KT-291052
MC# 1165025

INCLUDED IN THE KIT:



Looping Tool

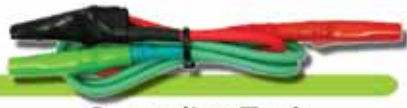

Grounding Tool

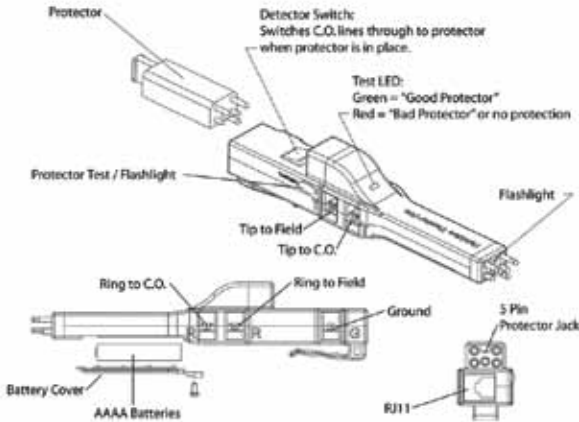

PRODUCT HIGHLIGHTS

- Access 5 pin location at building entrance, CEV, SLC remote, and Central Office with protection
- Isolate Central Office from field
- No need to disconnect pairs
- Test Protector Modules
- Flashlight

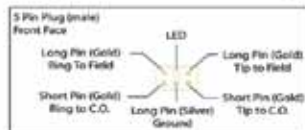
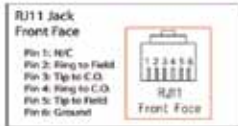

THE FASTEST ROUTE FROM DESIGN TO PRODUCTION

Westek's engineering team can put a working model in your hands!

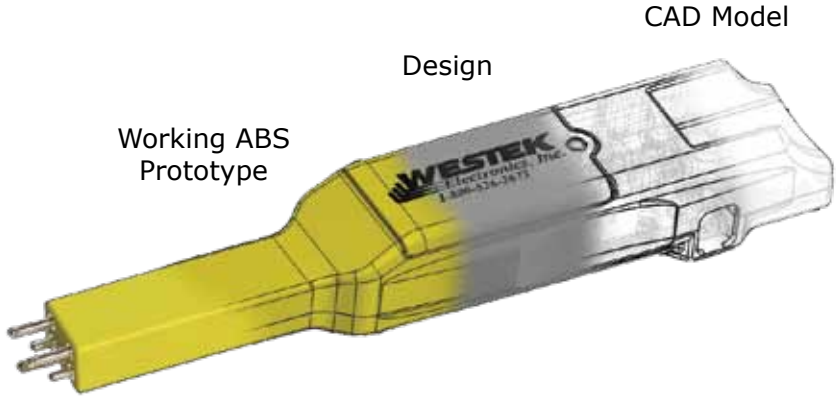

Nothing communicates design ideas faster than a three-dimensional part or model.

Westek can bring your CAD files and design ideas to life. Test form, fit and function using as many design iterations as you need with functional ABS parts to beat your competitors to the marketplace.

Unlike appearances prototypes produced in weak materials, our 3D printer will generate durable, working models in ABS (acrylonitrile butadiene styrene) plastic. ABS 3D models can withstand rigorous functional testing. ABS is the material of choice by leading manufacturers and is a major reason why our prototypes resemble a finished product.



Ph: 800.526.2673

www.westek.com

Fax: 800.526.3299



One service call, one test cord.
The OSP Combi-Cord

The **OSP Combi-Cord** reduces truck rolls, saves time and promotes productivity by having all of the necessary plug-in's on a one foot cord. Our cords are manufactured to the highest industry standard, proving themselves to be ultra durable. **The OSP Combi-Cords are listed on page 4-5 and available to Century Link technicians.**



Westek's OSP Combi-Cord features a 2 year warranty and excellent Westek Customer Service.

sales@westek.com
185 Westridge Drive
Watsonville CA 95076
Ph: 800.526.2673
Fax: 800.526.3299

QUALITY

- Westek's ISO, TL & UL Quality Assurance include risk management, experimental design, verification, validation, statistical techniques, gauge repeatability, reproducibility, and process capabilities.
- Westek's quality system is a continuous process from incoming material inspection, documentation of every manufacturing process, component identification for complete traceability, and 100% final inspection of all orders, regardless of size.
- Westek's product failure rate is less than 0.1 percent!
- Westek's certifications:
 - ISO 9001:2008 Certified**
 - TL 9000**
 - UL Listed & Approved**
 - BICSI member**
 - IPC-620A**
 - ITAR Compliant**

