

# 30 years of Excellence in Connectivity!



**WESTEK** Above the Ground, On the Ground, Under the Ground  
*Electronics, Inc.* **Large Universal Portable Worklight**



**Magnetically Attach:**

Splice Case Support Rack Brackets  
 Side of Vehicle or any metal surface

**Mechanically Clamp:**

Aerial Support Cables and wires  
 \* Safety Lanyard Provided



**Features:**

- 4000 Lumens
- 4x12 Led Bars
- withstands 100mph winds
- Charge 110/120
- Supports 100-200-300-5-10lbs payload
- Continuous lighting power on 110v
- Charging time 3-10hrs
- Heavy resistant IP65 certified
- Heavy Duty Construction

PID# ATT.200003526

PN:TC-LEDFLDLARGE



D Cable Latching Clamp (2) for Aerial Mounts for Pole Work

1(800) 526-2673 www.westek.com

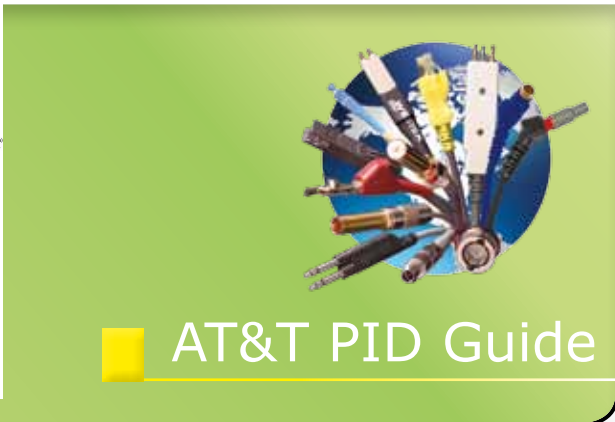

## AT&T PID Guide



## WESTEK ELECTRONICS EXPANDED TO NEW LOCATION

Westek has moved! This dynamic operational change is designed to assure continued commitment to optimum customer service and custom cable manufacturing excellence. From our new building headquartered in Watsonville, California, we will provide you with the highest level of service no matter how large the scope of your project may be.

Westek is the 4th company over all in the USA to be standardized to the upgraded ISO 5.0 Manufacturing Standard. "We could not be more proud of our team achieving this level of ISO certification. Our growth and continual improvement is a reflection of the well trained and dedicated staff." States, Michael Hushaw, Vice President Operations.

Westek Electronics, Inc. was the First Telecommunication Cable Manufacturer in the world to be certified to the LRQA (Lloyd's Register Quality Assurance) Re-Certification audit and "upgrade" to the ISO 9001:2008 standard back in August 2009.

Westek Electronics, Inc. is located in Santa Cruz County, at 185 Westridge Dr., Watsonville, CA 95076. For more information on Westek Electronics, Inc. products and services go to: [www.westek.com](http://www.westek.com) or call 800-526-CORD.

About Westek: Westek Electronics, Inc. has been a leader in Telecommunications for over 30 years. Westek Electronics, Inc. also specializes in the Test & Measurement, Medical and Military/GSA industries. Westek Electronics Inc., holds dual certification, as now audited by DEKRA, in regard to ISO 9001:2008 and TL9000-H since 2014. Westek Electronics, Inc. was the 6th company in the United States to be certified to revision 4.0 in TL 9000.

**NEW**

# AT&T Fiber Multi-Tool Solution

Male Loopback, Female Loopback, Plug-in Connector Coupler & Parking Lot

## Four Fiber Tools in One Pat. Pend. LC or SC

1. Dual LC or SC Male Plug for Loopback Electronics Testing
2. Dual LC or SC Female Plug for Loopback Cable Testing
3. Dual LC or SC Female Loopback
4. Park your exposed cable fiber plug ends, keeping them clean and damage free

*Slide all three components together to create a dustproof, crushproof and moisture resistant case*



☒ Dual LC Male Loopback Plug

☒ Dual LC Fiber Coupler

☒ Dual LC Female Loopback Plug

☒ Also Park your exposed Fiber ends keeping them clean and damage free

☒ Dual SC Male Loopback Plug

☒ Dual SC Fiber Coupler

3. Dual SC Female Loopback Plug

4. Also Park your exposed Fiber ends keeping them clean and damage free

### LC



Duplex LC Singlemode UPC 9/125  
FC LB7102  
ATT.100090125  
CEQ.15358

Duplex LC Multimode UPC 62.5/125  
FC LB7202  
ATT.100090126  
CEQ.15359

Duplex LC LO Multimode 50/125  
FC LB7502  
ATT.100090127  
CEQ.15360

Duplex LC Singlemode APC 9/125  
FC LB7102A  
ATT.100090131  
CEQ.15364

### SC



Duplex SC Singlemode UPC 9/125  
FC LB3102  
ATT.100090128  
CEQ.15361

Duplex SC Multimode UPC 62.5/125  
FC LB3202  
ATT.100090129  
CEQ.15362

Duplex SC LO Multimode UPC 50/125  
FC LB3502  
ATT.100090130  
CEQ.15363

Duplex SC Singlemode APC 9/125  
FC LB3102A  
ATT.100090132  
CEQ.15365



# Central Office Tech Fiber Kit

Ph: 800.526.2673 Fax: 800.526.3299

WWW.WESTEK.COM

KIT PN: KT COTFK

PID#ATT.200001367



**LC**  
Single Mode UPC  
PID NUMBER:  
ATT.100090125



**SC**  
Single Mode UPC  
PID NUMBER:  
ATT.100090128



Rugged LC/SC Fiber Loopback Plugs  
With Coupler and Parking Lot in  
Heavy Duty Unbreakable Waterproof  
Case with Lanyard

1. Dual Male Loopback Plug
2. Dual Fiber Coupler
3. Dual Female Loopback Plug
4. Park your exposed fiber ends keeping them clean and damage free

**PATENTED**

## 3 Tools In One Kit!

### Fiber Install & Removal Tool with Built in Flashlight



FOR FIBER OPTIC SC/LC PLUG  
INSERTION AND REMOVAL



KIT BAG INCLUDED  
FOR EASY TRANSPORT



**WESTEK**  
Electronics, Inc.

Your World. Connected.



# OSP Construction Fiber Kit



**SC**

Single Mode UPC  
PID NUMBER:  
ATT.100090128



**SC**

Single Mode APC  
PID NUMBER:  
ATT.100090132

**Order Number  
ATT.200000933**

## SC Fiber Loopback Plugs

Rugged SC Fiber Loopback Plugs  
With Coupler and Parking Lot in  
Heavy Duty Unbreakable Waterproof Case  
with Lanyard



1. Dual SC Male Loopback Plug

2. Dual SC Fiber Coupler

Dust Cover



3. Dual SC Female Loopback Plug

4. Park your exposed fiber ends  
keeping them clean and damage free

# 3 Tools In One Kit!

**PATENTED**

## Fiber Install & Removal Tool with Built in Flashlight



FOR FIBER OPTIC SC/LC PLUG  
INSERTION AND REMOVAL

PID NUMBER:  
ATT.100007441



KIT BAG INCLUDED  
FOR EASY TRANSPORT

[WWW.WESTEK.COM](http://WWW.WESTEK.COM)

Ph: 1-800-526-2673

[www.westek.com](http://www.westek.com)

Fax: 1-800-526-3299



# Portable Splice Case and Tray Mounting Support Tool

Creates a Universal Workstation Inside the Trailer or Out in the Field



## Order Number ATT.200000931

Tool Clamp Fiber Splice Case 18"  
(as shown below)

*\*Carrying Case Included*

Westek's clamping system is designed to position and hold fiber splice case enclosure housings during servicing.



The universal vice can be fitted into the clamp receiver and tightened to allow the splice tray to be positioned at the preferred angle. Includes, locking 18" C-clamp with female receiver, universal vice, universal mounting tube.

**Patent Pending**

800.526.2673

Pole Adapts to Existing Splice Case Brackets

[WWW.WESTEK.COM](http://WWW.WESTEK.COM)



Your World. Connected.



# Portable Splice Case and Tray Mounting Support Tool

Creates a Universal Workstation Inside the Trailer or Out in the Field



## Order Number ATT.200000932

Tool Clamp Fiber Splice Case 11"  
(as shown below)

*\*Carrying Case Included*

Westek's clamping system is designed to position and hold fiber splice case enclosure housings during servicing.

**Patent Pending**

800.526.2673

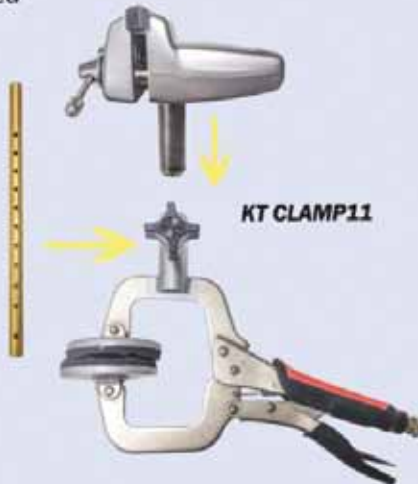

Pole Adapts to Existing Splice Case Brackets

The universal vice can be fitted into the clamp receiver and tightened to allow the splice tray to be positioned at the preferred angle. Includes, locking 11" C-clamp with female receiver, universal vice, universal mounting tube.

WWW.WESTEK.COM

Ph: 1-800-526-2673

www.westek.com

Fax: 1-800-526-3299

# Partner For Fiber Success

## WESTEK'S ALL NEW FIBER TOOL

For Fiber Optic LC Plug Insertion and Removal

Westek's Fiber Tool installs and removes LC connectors. This elegant device simply fits into a shirt pocket or tool pouch and is ergonomically designed to fit the hands of today's technician while at the same time mitigates any potential for repetitive motion or significant squeeze issues/injuries. Supports most Fiber optic connectors and exceeds the stringent requirements dictated by Telcordia Technologies, ANSI, OSHA, FDA, NTA and the IEC.



Fiber Tool - FP 360023 \*

ATT.10007441

- Integrated flashlight feature enables tech to see in low-lit areas
- Extremely well balanced with ergonomic pads that provide the minimum pressure necessary to capture/place the connector
- Eliminates from touching or moving other connectors preventing service disruption
- Patented locking ratchet design to hold plugs securely.
- Designed to fit comfortably in either hand
- One Year Warranty



TL9000

Bicsi

WWW.WESTEK.COM

ORDER ONLINE NOW

**WESTEK**  
Electronics, Inc.

ph: 800-526-CORD fax: 800-526-FAXX Expect the Best.

TO SEE OUR COMPLETE LINE OF TIME SAVING  
TECH TOOLS ALONG WITH ONLINE ORDERING  
PLEASE VISIT US AT: [WWW.WESTEK.COM](http://WWW.WESTEK.COM)

**WESTEK**  
Electronics, Inc.

Your World. Connected.



"Streamlining Technician Productivity"  
**OSP Pair Bonding Pidded**  
**Test Cords**

Patented  
 Unbreakable RJ45



**PIN TC-PB2F**  
**ATT.200001475**

**Dat Term**

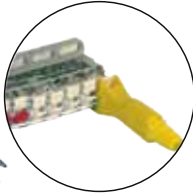

**PIN TC-PB2A**  
**ATT.200001473**

**110**

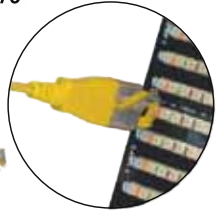

**PIN TC-PB2G**  
**ATT.200001472**

**526**

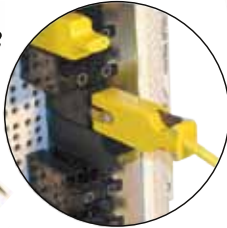

**PIN TC-PB2H**  
**ATT.200001471**

**Self Strip**



**PIN TC-PB2J**  
**ATT.200001394**

**2827**



**PIN TC-PB2E**  
**ATT.200001474**

**Binding Post**



# Portable 1500 Lumen LED Flood Light

WESTEK Cable and Telecom Solutions

Patent Pending

## Overview

Westek's new patent pending portable 1500 lumen LED flood light provides superior lighting, runtime, and mounting options to meet the needs of todays technicians.

## Features and Benefits

- Super Bright 1500 Lumen COB LED
- Rugged IP65 outdoor rated
- Patent pending magnetic base with ultra strong, non marring, 112lb holding power neodymium magnets (x3) withstands 100mph+ winds
- Integrated Lashing "Bug" clamp for aerial strand mounting
- Rechargeable Li-ion batteries with twice the capacity of off the shelf lights
- 360° adjustable stand for unlimited lighting positions
- Portable & light weight
- Adaptable bracket stand for customizable mounting.
- 1 year limited warranty

### Specifications:

- Light Source: COB LED
- Lumens: 1500 Lumens
- 2-Mode: High-Low
- IP Rating: IP65
- Power: 15W
- LED Lifespan: 100,000 Hours
- Powered by Li-ion Batteries
- Runtime: 8-9 hrs High  
10-15 hrs Low
- Charge time: 5-7hrs
- Size: 10 x 6.5 x 6 in.



P/N TC-LEDFLDSMALL  
PID#ATT.200003527



Aerial Strand  
Mounting

# Portable 4500 Lumen LED Flood Light

WESTEK Cable and Telecom Solutions

## Overview

Westek's new patent pending portable 4500 Lumen LED flood light provides superior lighting, runtime, and mounting options to meet the needs of today's technicians.

## Features and Benefits

- Super Bright 4500 Lumen COB LED
- Rugged IP65 outdoor rated
- Patent pending magnetic base with ultra strong, non marring, 112lb holding power neodymium magnets (x6)
- Integrated Lashing "Bug" clamp for aerial strand mounting
- Rechargeable Li-ion batteries with twice the capacity of off the shelf lights.
- 360° adjustable stand for unlimited lighting positions
- Adaptable bracket stand with strap for customizable mounting
- Portable & light weight
- 1 year limited warranty

### Specifications:

- Light Source: LED (COB)
- Lumens: 4500 Lumens
- IP Rating: IP65
- Power: 50W
- LED Lifespan: 50,000 Hours
- Powered by Li-ion Battery pack
- Runtime: 6-8 hrs High  
9-14 Low
- Charge time: 5-7hrs
- Size: 16.5 x 13 x 6 in.



P/N TC-LEDFLDLARGE  
PID#ATT.200003526

Aerial Strand  
Mounting

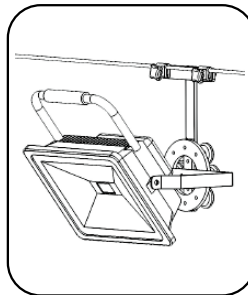

Utility Pole  
Mounting

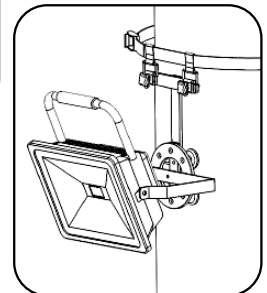

Ph: 1-800-526-2673

[www.westek.com](http://www.westek.com)

Fax: 1-800-526-3299

# Workstation

	<b>PID #</b>	<b>Description</b>	<b>Part #</b>
	ATT.200003449	Vise Kit Table Mount Westek Workstation	KT TTVISE
	ATT.200003460	Fixture End Plate Universal with Post Adapter Westek Workstation	KT SC3
	ATT.200003466	Tray Kit No 1 Westek Workstation	KT TRAY1
	ATT.200003444	Tray Kit No 2 Westek Workstation	KT TRAY2
	ATT.200003458	Tray Kit Wall Mount No 1 Westek Workstation	KT TRAYMT
	ATT.200003454	Tray Kit Wall Mount No 2 Westek Workstation	KT TRAY2MT

# Workstation

	<b>PID #</b>	<b>Description</b>	<b>Part #</b>
	ATT.200003448	Tray Kit No 1 Bucket 18 Inch Westek Workstation	KT CL18TB
	ATT.200003467	Tray Kit No 2 Bucket 18 Inch Westek Workstation	KT CL18T2B
	ATT.200003459	Tray Kit No 1 Bucket 11 Inch Westek Workstation	KT CL11TB
	ATT.200003451	Tray Kit No 2 Bucket 11 Inch Westek Workstation	KT CL112TB
	ATT.200003464	Workstation Westek 11 Inch Kit 1	KT CL11TMT
	ATT.200003468	Workstation Westek 18 Inch Kit 2	KT CL18TMT

# Workstation

	PID #	Description	Part #
	ATT.200003445	Workstation Westek 11 Inch Kit 3	KT CL11T2MT
	ATT.200003463	Workstation Westek 18 Inch Kit 4	KT CL18T- 2MT4
	ATT.200003470	Tube Extension 12 Inch Westek Workstation	TC-053301
	ATT.200003471	Tube Extension 90 Degree 9 Inch Westek Workstation	TC-053302
	ATT.200003447	Tube Extension 90 Degree 3 Inch Westek Workstation	TC-053308
	ATT.200003450	Post Adapter Long Westek Workstation	TC-053310
	ATT.200003456	Post Adapter Short Westek Workstation	TC-053309
	ATT.200003462	Post Adapter Tripod Westek Workstation	TC-053316
	ATT.200003465	Pad Clamp Westek Workstation	MH 053315
	ATT.200003441	Tripod Westek Workstation	TC-TRIPOD

# Workstation

	<b>PID #</b>	<b>Description</b>	<b>Part #</b>
	ATT.200003461	Clamp 11 Inch Westek Workstation	TC-CLAMP11
	ATT.200003455	Clamp 18 Inch Westek Workstation	TC-CLAMP18
	ATT.200003443	Tray Small Westek Workstation	TC-TRAY
	ATT.200003457	Tray Large Westek Workstation	TC-TRAY2
	ATT.200003469	Tray Clip On For Westek Workstation Trays	TC-053307
	ATT.200003446	Mount Wall and Table Post Receiver Westek Workstation	TC-TTMOUNT
	ATT.200003452	Vice Westek Workstation	TC-VISE
	ATT.200003442	Tube Adapter Westek Workstation	TC-TUBE
	ATT.200003453	Fixture End Plate Universal Without Post Adapter Westek Workstation	TC-SC3

# Workstation

	PID #	Description	Part #
	ATT.200003527	Light LED Small Portable 1500 Lumen	TC-LEDFLD SMALL
	ATT.200003526	Light LED Large Portable 4500 Lumen	TC-LEDFLD LARGE
	ATT.200003523	Light Kit No 1 LED Westek	KT LEDFLDHC
	ATT.200003522	Light Kit No 2 LED Westek	KT LEDDLDA
	ATT.200003534	Light Kit Dual Small LED with 11 Inch Clamp Westek	KT CL11D LEDS
	ATT.200003524	Light Kit Dual Small LED with 18 Inch Clamp Westek	KT CL18D LEDS



# Workstation

	PID #	Description	Part #
	ATT.200003530	Light Kit Dual Large LED with 11 Inch Clamp Westek	KT CL11D LEDL
	ATT.200003529	Light Kit Dual Large LED with 18 Inch Clamp Westek	KT CL18D LEDL
	ATT.200003532	Handclamp for Westek LED Lights	TC-HAND CLAMP
	ATT.200003525	Adapter Light Kit for Westek LED Lights	KT LEDADPT
	ATT.200003531	Bracket Dual for Westek LED Lights	KT LEDADPT2
	ATT.200003528	Bag Accessory Westek Workstation and/or LED Lights	CB 05192 CLP
	ATT.200003533	Case Travel Westek Workstation	CB TRAVEL
	ATT.200000932	Clamp Kit 11 Inch Westek Workstation	KT CLAMP11
	ATT.200000931	Clamp Kit 18 Inch Westek Workstation	KT CLAMP18

Ph: 1-800-526-2673

Fax: 1-800-526-3299

www.westek.com

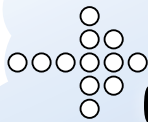

# One Tech, One Ticket.

Reduce Repeat Repairs

The OSP product line reduces truck rolls, saves time and promotes productivity by having all of the necessary tools needed on the job.

Test right the first time! With the OSP time saving tools from Westek, one technician can tackle one ticket.



NIU Cord Kit  
KT 291064  
PID# ATT.100039786

Laptop Kit  
KT 290152  
PID# ATT.100067415



Tel-Line Tester Pro  
TC-TLTS-PRO  
PID# ATT.100011483

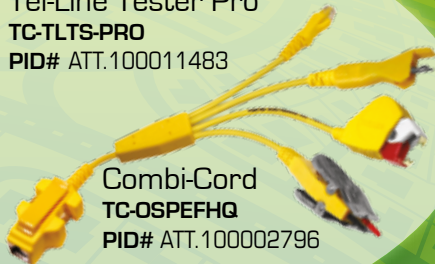

Combi-Cord  
TC-OSPEFHQ  
PID# ATT.100002796

**WESTEK**  
Electronics, Inc.

# KT DEG1000

PID# ATT.100089683



## OVERVIEW

Westek offers premium test and patch cord kits encompassing the right tools needed to perform a specific job. Westek's DEG Kit is a time-saving solution that allows Digital Electronics Group technicians to configure multiple combinations of 25 pin and 9 pin style cables in one portable easy-to-use kit. Our kit allows your laptop to quickly and easily interface with T1, Ethernet, Modems, Routers, "D-Slam" units, and Comports.

This kit contains the most essential tools for telecommunications professionals making it ideal for maintaining and troubleshooting your network. The DEG kit features Westek's patented solutions that increase tech productivity, eliminate breakage and insure more accurate testing. The DEG Kit is both highly efficient and complete because it was designed with input from telco professionals.

## KT DEG1000

PID# ATT.100089683

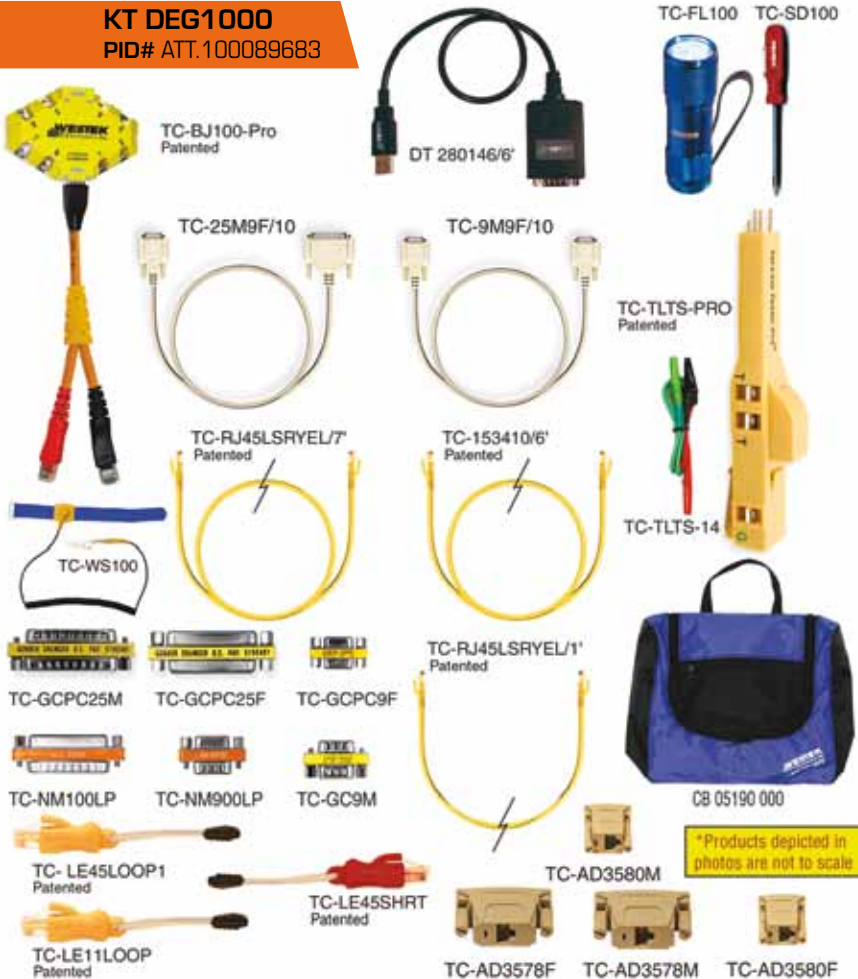



\*Products depicted in photos are not to scale

Ph: 1-800-526-2673

Fax: 1-800-526-3299

www.westek.com

# OSP Combi-Cords

	PID #	Description	Part #
 <p><b>New</b></p> <p>See page 33 for details</p>	ATT.100089797	<b>Combi-Cord</b> Clip Access/RJ11 Chuck Ends 5 Pin 463A P2FM P2EF	TC-HYBNRU
	ATT.100002796	<b>Combi-Cord</b> Clip Access/RJ11 Self Strip Clip Binding Post Clip Dat Term RJ11LE	TC-OSPEFHQ
	ATT.100034634	<b>Combi-Cord</b> Clip Access/RJ11 110 Block 66 Block L3 (526) 5 Pin	TC-OSPACGN

# OSP Combi-Cords

## WESTEK CABLE AND TEST SOLUTIONS

### OVERVIEW

Westek's OSP Combi-Cord is a multiended test cord that allows technicians to access various types of terminal and connector blocks with one cable. OSP Combi-Cords provide technicians with all the necessary plug-ins on a one foot cable.

### FEATURES AND BENEFITS

- More productive circuit testing by having four different test plugs on one test cord.
- Easy testing of POTS, ADSL and VDSL.
- Works with all major test sets and tone generators.
- Test clips for easy butt set access.
- 7" Lanyard for weight relief.
- Reduced truck rolls by having four different test plugs on a single cord.
- No more loss of multiple test access cords.
- Cost savings by replacing four test cords with one multi connector test cord.
- Manufactured to the highest industry standards.
- Belt clip for easy transportation.
- Protective dust covers for RJ11, 5 pin L4 (463A) and L3 (526) connectors.
- RJ-11 looping plug available.
- Molded in bright yellow to prevent misplacement.
- Designed to fit most tool pouches.
- 2 year warranty.

### SPECIFICATIONS

Cable	2 Conductor, 24AWG, twisted pair, shielded
Voltage	500V (Dielectric Strength)
Insulation	Jacket: Polyvinyl Chloride -PVC, Conductors: Polypropylene
Operating Temperature	-4° F to 176° F (-20° C to + 80° C)
Humidity	90% (non-condensing) max.
Length	12 inches (31 cm)
Weight	5 oz (150 g)
RJ11 Looping Tool	PN: TC-LE11LOOP



Ph: 1-800-526-2673

[www.westek.com](http://www.westek.com)

Fax: 1-800-526-3299

# TEL-LINE TESTER™ KIT

## OSP Troubleshooting Kit

Now Cable Maintenance Technicians Can Troubleshoot Cable Pairs Fast!

Important time saving tool kit for cable maintenance. Now troubleshoot cable pairs in seconds and eliminate repeat repairs. Look into the central office or out to the field in seconds!

The Tel-Line Tester™ automatically splits the central office from the field! Access cable pairs by plugging into any five pin connector block located at the building entrance (SLC remote, CEV, or Central Office).

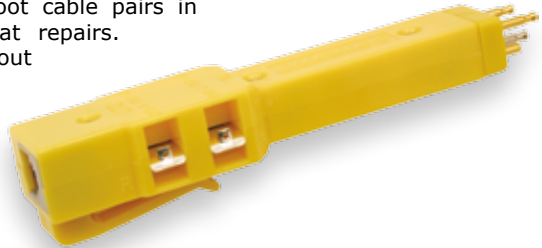

To troubleshoot the switch, simply clip a buttset or voltmeter to the metal tabs marked "Tip" and "Ring In" and look to the switch. Move the clips to the tabs marked "Tip" and "Ring Out" and look to the field. To restore temporary service to the customer while troubleshooting, simply plug in the OSP kit's modular looping tool. The Westek Tel-Line Tester™ facilitates Bell System Practice (BSP). Connect a Craft access terminal or Trans Test Access Network to close out the trouble and pull up the next job ticket.

### Tel-Line Tester™ Kit - TC-TLTS-2

Includes:  
Looping plug,  
Craft Access  
wall cord.



**PID#** ATT.100400650

### Tel-Line Tester™ - TC-TLTS 1A



Tester unit only

**PID#** ATT.100066060

### Product Highlights

Access 5 pin location at building entrance, CEV, SLC remote, and Central Office

Isolate Central Office from field

No need to disconnect pairs

Built tough and durable

Full two year warranty

# TEL-LINE TESTER PRO™ KIT

PID# ATT.100011765

KT-291052

## Tel-Line Tester Pro™

Allows you to troubleshoot cable pairs in seconds

**PATENTED**

Light your way to a solution



**-Three Step Testing-**



### STEP 1: REMOVE PROTECTOR

Access using 5 Pin Protector at building entrance, CEV, SLC remote and Central Office with protection.

Removes the need to physically cut into the line to isolate the pair.

### STEP 2: TEST PROTECTOR

Insert protector into Tel-Line Tester Pro. Press "Test" Button. Test light LED glows **Green** if protector is good, and **Red** if the protector is bad.

A white LED flashlight is located at the tip for locating target.



### STEP 3: TROUBLESHOOT

Clip a buttset or voltmeter to the metal tabs marked "Tip" and "Ring in" and look to the switch. Move the clips to the tabs marked "Tip" and "Ring out" and look to the field. To restore temporary service to the customer while troubleshooting, simply plug in the OSP kit's modular looping tool.

## Tel-Line Tester Pro Kit



Kit includes: looping tool & grounding tool

Ph: 1-800-526-2673

www.westek.com

Fax: 1-800-526-3299

## Banana Kit

### KT BananaKit

**PID#** ATT.100420160

RFL test set replacement cord kit  
(includes all three pictured cords)



TC-3300BPGN (5')  
R/A Banana Grn to LHTCABP Grn  
**PID#** ATT.100420130

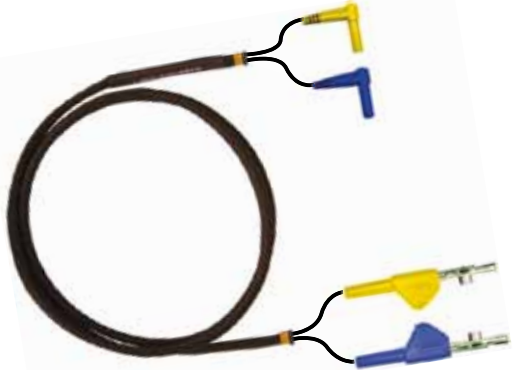

TC-3300BPYB (5')  
2 R/A Bananas Yel/Blu to 2  
LHTCABP Yel/Blu  
**PID#** ATT.100420150

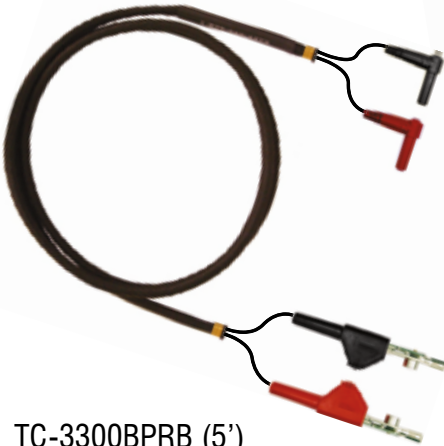

TC-3300BPRB (5')  
2 R/A Bananas Red/Blk to  
2 LHTCABP Red/Blk  
**PID#** ATT.100420140





## Buttset Replacement Cord

1. TC 162209 [TS22]  
ATT.100050955  
For TS22

2. TC 162202 [TS44]  
ATT.100011861  
For TS44 or 52



Ph: 1-800-526-2673

[www.westek.com](http://www.westek.com)

Fax: 1-800-526-3299

## NIU Cord Kit

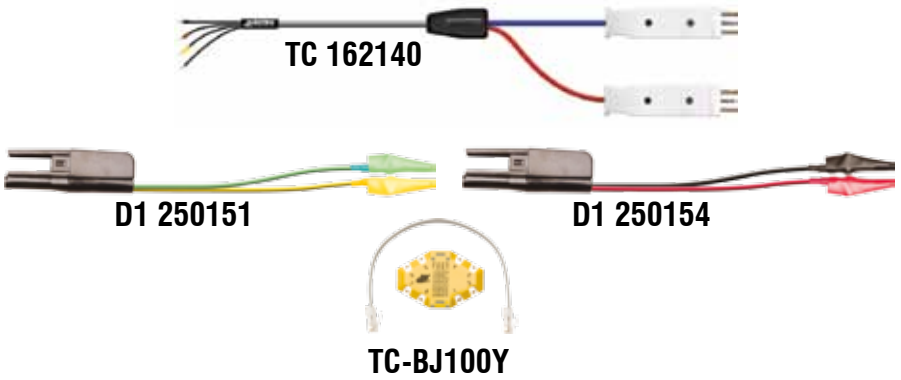

**PID#**  
ATT.100039786

**Part # KT 291064**

### Kit Contents

### Part Number

### PID

Kit Bag CB	CB 05190000	ATT.100017064
Banjo - Yellow with RJ45 Lan Cord	TC-BJ100Y	ATT.1000172647
(4) Round Lugs Y 463A Looking In	TC 162140	ATT.1000168079
Protect Cradle-(2) Alligator Clips, Red&Black	D1 250151	ATT.1000172648
Protect Cradle-(2) Alligator Clips, Green&Yellow	D1 250154	ATT.1000172649

**T-BERD 2209 Tech Kit**



<b>Kit Contents</b>	<b>Part Number</b>	<b>PID</b>
1 - Bantam to 463A, Alligator Clips and holstered Bantam 15' Blue Cord	TCC-232 TX	N/A
1 - Bantam to 463A, Alligator Clips and holstered Bantam 15' Red Cord	TCC-232 RX	N/A
2 - Bantam Terminating Plug, 100 Ohms	TC-TP200	ATT.100000569
2 - Tel-Line Tester	TC-TLTS 1A	ATT.100066060
1 - 440A to 440A, 8' Blue Cord	TC-440A/TX	ATT.100067369
1 - 440A to 440A, 8' Red Cord	TC-440A/RX	ATT.100067421
1 - Female RJ45 to Red & Blue Bantam, 8' Cord	TC 16118	N/A
1 - RJ48 to Y Bantam wired 1245, 8' Cord	TC-TR248C	ATT.100067460
1 - BNC Coupler	TC-BNCCPLR	ATT.100067506
1 - RJ48 T1 Shorting Plug	TC-LPRJ48C	ATT.100067495
1 - 3' AC Power Cord	TC-PC01/3	N/A
1 - RJ48 to RJ48, 10' Royal Blue Cord	TC-140	ATT.100067318
1 - 310 to Bantam Adapter Blue	TC-AD310B	ATT.100000585
1 - 310 to Bantam Adapter Red	TC-AD310R	ATT.100067384
1 - Cord Bag with Westek Logo	TC-P01	ATT.100068131

**PID # ATT.100001173**

**Part # KT 290041**  
**Part # KT 290041A**

### **DSX3 Coax Test Kit**



<b>Kit Contents</b>	<b>Part Number</b>	<b>PID</b>
1 - BNC to BNC 8' Red Cord	TC-500RX	ATT.100068895
1 - BNC to BNC 8' Blue Cord	TC-500TX	ATT.100068896
4 - 440A to BNC Adapter	TC-AD440	ATT.100011777
4 - 358A to BNC Adapter	TC-AD358	ATT.100011779
1 - Cord Bag	CB 05190 000	ATT.100017064
1 - Bantam to Bantam 8' Blue Cord	TC-200TX	
1 - Bantam to Bantam 8' Red Cord	TC-200RX	

**DARRT Cord Kit**



<b>Kit Contents</b>	<b>Part Number</b>	<b>PID</b>
1 - 310 "Y" to 15 pin Female, 2' Cord	TC-15F310/2	239 013 303
1 - 310 to 463A, Alligator Clips and holstered Bantam 15' Blue Cord	TCC-323TX	ATT.100067423
1 - 310 to 463A, Alligator Clips and holstered Bantam 15' Red Cord	TCC-323RX	ATT.100017276
1 - Female 310 to Heavy Test Clips with bed of nails 10' Blue Cord	TC-360FLTBTX/10	N/A
1 - Female 310 to Heavy Test Clips with bed of nails 10' Red Cord	TC-360FLTBRX/10	N/A
1 - 310 to Bantam Adapter Blue	TC-AD310B	ATT.100000585
1 - 310 to Bantam Adapter Red	TC-AD310R	ATT.100067384
1 - Bantam to Bantam, 25' Blue Cord	TC-200TX/25	N/A
1 - Bantam to Bantam, 25' Red Cord	TC-200RX/25	N/A
2 - RJ45 coupler	TC-CPLR45	N/A
1 - RJ45 to 9 pin Male Adapter - OC48 wiring	TC 16382	ATT.100038289
1 - RJ45 to 25 pin Male Adapter - DARRT Null Modem	TC 16394	N/A
1 - RJ45 to 25 pin Male Adapter - FMT 150 wiring	TC 16388	N/A
1 - RJ45 to 9 pin Female Adapter, special wiring	TC 16400	N/A
1 - RJ45 to 25 pin Male Adapter, Fujitsu	TC 16391	ATT.100038290
2 - RJ45 to RJ45, 50' Cord	TC-RJ48/50	N/A
1 - Large Cord Bag	CB 22000 000	N/A

**DSX 1 Deluxe Test Kit**



Kit Contents	Part Number	PID
2 - Bantam to Bantam, 8' Blue Cord	TC-200TX	N/A
2 - Bantam to Bantam, 8' Red Cord	TC-200RX	N/A
2 - Bantam to 310, 8' Blue Cord	TC-230TX	ATT.100074249
2 - Bantam to 310, 8' Red Cord	TC-230RX	ATT.100074250
1 - Bantam to Alligators, 8' Blue Cord	TC-260TX	N/A
1 - Bantam to Alligators, 8' Red Cord	TC-260RX	N/A
1 - 310 to Bantam Adapter Blue	TC-AD310B	ATT.100000585
1 - 310 to Bantam Adapter Red	TC-AD310R	ATT.100067384
1 - Dual Bantam Looping Plug, 3 Conductor	TC-LP250	ATT.100000583
2 - Bantam Terminating Plug, 135 Ohms	TC-TP201	ATT.100067454
1 - 310 to RJ11, 8' Cord	TC-311	N/A
1 - Dual Bantam to RJ45, 8' Cord	TC-259	N/A
2 - 66 Block Adapter	TC-AD66	N/A
1 - 3' AC Power Cord	TC-PC01/3	N/A
1 - Westek Screwdriver	TC-SD100	N/A
1 - Westek Flashlight	TC-FL100	N/A
1 - Pliers Plus	TC-PL100	N/A
1 - Cord Bag with Westek Logo	TC-P01	ATT.100068131

**High Capacity Provisioning Kit**



<b>Kit Contents</b>	<b>Part Number</b>	<b>PID</b>
1 - RJ45 to 9 pin Male Adapter - OC48 wiring	TC 16382	ATT.100038289
1 - RJ45 to 15 pin Male Adapter	TC 16409	N/A
1 - RJ45 to 25 pin Male Adapter, Fujitsu	TC 16391	ATT.100038290
1 - 25 pin Male to 25 pin Female, Low Profile Null Modem	TC-NM100LP	201 013 257
1 - 9 pin Male to 9 pin Female, Low Profile Null Modem	TC-NM900LP	202 013 256
1 - RJ45 to RJ45, 30' Cord	TC-RJ48/30	N/A
1 - RJ45 Coupler	TC-CPLR45	N/A
1 - RJ45 to 9 pin Female, no wiring	TC-AD9FRJ45	N/A
1 - Cord Bag	CB 05190 000	ATT.100017064

### Universal Laptop Test Kit



Kit Contents	Part Number	PID
1 - 25 pin Male to 9 pin Female, 10' Cord - special wiring	TC-25M9F/10	245 013 305
1 - 9 pin Male to 9 pin Female, 10' Cord - straight wiring	TC-9M9F/10	ATT.100080925
1 - DB9 Female to Female, Gender Changer	TC-GCPC9F	ATT.100076986
1 - DB9 Male to Male, Gender Changer	TC-GC9M	206 013 252
1 - DB25 Male to Male, Gender Changer	TC-GCPC25M	203 013 255
1 - DB25 Female to Female, Gender Changer	TC-GCPC25F	204 013 254
1 - 25 pin Male to 25 pin Female, Low Profile Null Modem	TC-NM100LP	201 013 257
1 - 9 pin Male to 9 pin Female, Low Profile Null Modem	TC-NM900LP	202 013 256
1 - RJ48C Shorting Tool	TC-LPRJ48C	ATT.100067495
1 - RJ48 Ethernet Looping Plug	TC-LPRJ48E	ATT.100067496
1 - Westek Screwdriver	TC-SD100	N/A
1 - Westek Flashlight	TC-FL100	N/A
1 - ESD Wrist Strap	TC-WS100	N/A
1 - Cord Bag	CB 05190 000	ATT.100017064



**DSX1 Standard Test Kit**



<b>Kit Contents</b>	<b>Part Number</b>	<b>PID</b>
2 - 310 to Alligators, 8' Cord	TC-360	ATT.100000661
5 - Bantam to 310, 8' Cord	TC-230	ATT.100067336
1 - Dual Bantam to RJ45, 8' Cord	TC-259	N/A
2 - 310 to 310, 8' Cord	TC-310	ATT.100067388
2 - Bantam to Bantam, 8' Cord	TC-200	ATT.100067320
2 - Bantam to Alligators, 8' Cord	TC-260	ATT.100067351
1 - RJ45 to "Y" 310	TC-TR348C	N/A
1 - 3' AC Power Cord	TC-PC01/3	N/A
1 - Westek Screwdriver	TC-SD100	N/A
1 - Westek Flashlight	TC-FL100	N/A
1 - Cord Bag with Westek logo	TC-P01	ATT.100068131

### CO Toll Group Test Kit



Kit Contents	Part Number	PID
1 - BNC to BNC, 8' Blue Cord	TC-500TX	608 992 814
1 - BNC to BNC, 8' Red Cord	TC-500RX	608 992 815
2 - LCC to BNC, 10' Cord	TC-531/10	ATT.100070674
4 - 440A to BNC Adapter	TC-AD440	ATT.100011777
4 - 358A to BNC Adapter	TC-AD358	ATT.100011779
1 - Westek Screwdriver	TC-SD100	N/A
1 - Westek Flashlight	TC-FL100	N/A
1 - Cord Bag	CB 05190 000	ATT.100017064

**Tech Support Transport Laptop Kit**



<b>Kit Contents</b>	<b>Part Number</b>	<b>PID</b>
1 - 25 pin Male to 25 pin Male, staight wiring, 3' Cord	TC 16493/3	N/A
1 - 310 to Bantam Adapter Blue	TC-AD310B	ATT.100000585
1 - 310 to Bantam Adapter Red	TC-AD310R	ATT.100067384
1 - Bantam to Minigrabbers, 8' Blue Cord	TC-240TX/8	N/A
1 - Bantam to Minigrabbers, 8' Red Cord	TC-240RX/8	N/A
1 - Bantam to Dual Banana, 8' Cord	TC-204	N/A
2 - Minigrabbers to Minigrabbers, 6' Cord	TC-700	ATT.100031457
1 - DB9 Female to Female, Gender Changer	TC-GCPC9F	ATT.100076986
1 - DB9 Male to Male, Gender Changer	TC-GC9M	206 013 252
1 - DB25 Male to Male, Gender Changer	TC-GCPC25M	203 013 255
1 - DB25 Female to Female, Gender Changer	TC-GCPC25F	204 013 254
1 - 25 pin Male to 25 pin Female, Low Profile Null Modem	TC-NM100LP	201 013 257
1 - 9 pin Male to 9 pin Female, Low Profile Null Modem	TC-NM900LP	202 013 256
1 - RJ48C Shorting Tool	TC-LPRJ48C	ATT.100067495
1 - RJ48 Ethernet Looping Plug	TC-LPRJ48E	ATT.100067496
1 - Westek Screwdriver	TC-SD100	N/A
1 - Westek Flashlight	TC-FL100	N/A
1 - Large Cord Bag	CB 22000 000	N/A

### DLC Test Cord Kit



Kit Contents	Part Number	PID
1 - Bantam to Bantam, 8' Blue Cord	TC-200TX	N/A
1 - Bantam to Bantam, 8' Red Cord	TC-200RX	N/A
1 - Bantam to Alligators, 8' Blue Cord	TC-260TX	N/A
1 - Bantam to Alligators, 8' Red Cord	TC-260RX	N/A
2 - 800 Simplex to Bantam, 6' Cord	TC-820	974 012 080
2 - 463A to Bantam, 8' Cord	TC-5P200	ATT.100067374
1 - 463A to Alligator Clips	TC-5P600/16	973 012 081
1 - Bantam to 310 Female, 1' Cord	TC-203S	ATT.100067332
1 - 9 pin Male to 9 pin Female, 15' Cord	TC-9M9F/15	ATT.100068100
2 - Tel-Line Tester	TC-TLTS 1A	ATT.100066060
2 - 310 to Bantam Adapter Blue	TC-AD310B	ATT.100000585
2 - 310 to Bantam Adapter Red	TC-AD310R	ATT.100067384
1 - Cord Bag with Westek Logo	TC-P01	ATT.100068131

**AT&T Coax Kit**



<b>Kit Contents</b>	<b>Part Number</b>	<b>PID</b>
1 - BNC to BNC, 8' Red Cord	TC-500RX	607 992 815
1 - BNC to BNC, 8' Blue Cord	TC-500TX	608 992 814
4 - 440A to BNC Adapter	TC-AD440	ATT.100011777
4 - 358A to BNC Adapter	TC-AD358	ATT.100011779
2 - BNC to LCP, 4 inch Cord	TC 16298/4"	N/A
2 - Female BNC to LCC, 4 inch Cord	TC 16445/4"	N/A
4 - BNC Coupler	TC-BNCCPLR	ATT.100067506
1 - Cord Bag	CB 05190 000	ATT.100017064

### PC Direct Connect Data Kit



Kit Contents	Part Number	PID
1 - RJ45 to 9 pin Female CAT5, Cisco wiring, 6' Cord	DT 280101	N/A
1 - 9 pin Male to 9 pin Female, 10' Cord	TC-9M9F/10	ATT.100080925
1 - 9 pin Male to 9 pin Female, 20' Cord	TC-9M9F/20	N/A
1 - 9 pin Male to 25 pin Female Adapter, no screws or standoffs on 9 pin Male side	TC 16805	N/A
1 - 9 pin Female to 25 pin Male Adapter	TC-AD25M9F	N/A
1 - 9 pin Male to 9 pin Female, Null Modem	TC-NM900LP	202 013 256
1 - Cord Bag	CB 05190 000	ATT.100017064

**PID # 301 057 097**  
**301 057 105**  
**424 950 590**

**Part # KT 290026**

### **T-BERD 209 Cord Kit**



<b>Kit Contents</b>	<b>Part Number</b>	<b>PID</b>
1 - 310 to 463A, Alligator Clips and holstered Bantam 15' Blue Cord	TCC-323 TX	ATT.100067423
1 - 310 to 463A, Alligator Clips and holstered Bantam 15' Red Cord	TCC-323 RX	ATT.100017276
1 - 15 pin Female to "Y" 310, 2' Cord	TC-15F310/2	239 013 303
1 - Dual Bantam to Female 310, 1' Blue Cord	TC-227ATX/1	237 013 305
1 - Dual Bantam to Female 310, 1' Red Cord	TC-227A RX/1	238 013 304
1 - Westek Screwdriver	TC-SD100	N/A
1 - Westek Flashlight	TC-FL100	N/A
1 - RJ48 to RJ48, 10' Royal Blue Cord	TC-140	ATT.100067318
1 - 310 to Bantam Adapter Blue	TC-AD310B	ATT.100000585
1 - 310 to Bantam Adapter Red	TC-AD310R	ATT.100067384
1 - Cord Bag with Westek Logo	TC-P01	ATT.100068131

Ph: 1-800-526-2673

Fax: 1-800-526-3299

[www.westek.com](http://www.westek.com)

# Combi-Cord Sample Order

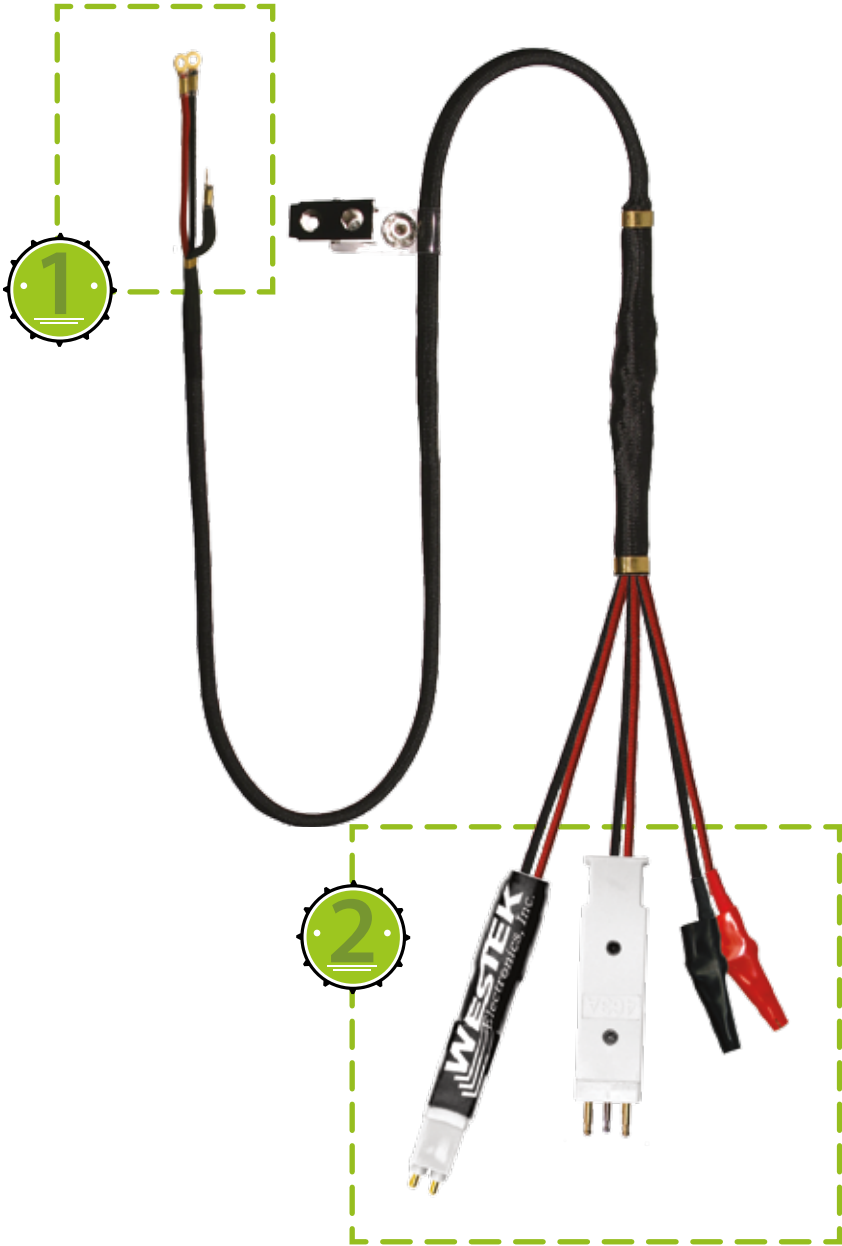





## Steps to ordering Combi-Cords:

1

Choose Buttset End Connection

2

Choose Components  
(Up to 5 Total)

## *Combi-Cord Benefits*

- Ultra-durable nylon braided jacket guarantees ruggedness and flexibility.
- Junction is constructed using insulated piercing lugs secured by a lock nut with a solder weld.
- Highest quality components made of state of the art materials insure long life and dependability.
- Red/Black nylon braided jacket protects insulated tinsel conductor.
- Combi Clip keeps plugs that are not in use up and out of the way.

# Combi-Cord Ends



## Choose Buttset End Connection

**B1**....Hardware (w/Strain Relief)



**B3**....Hardwire (Round Lugs)



**B4**....Modular Type, 4 Conductor, RJ22



**B6**....Modular Type, 6 Conductor, RJ11



**B8**....Modular Type, 8 Conductor, RJ45 / RJ48



**TS22**....For Fluke/Harris test sets



**TS44/TS52**.... For Fluke/Harris test sets



**B2**.... Quick Disconnect Option (471A QD or WECO Type 471A QD)



# Combi-Cord Ends



## Choose Components (Up to 5 Total)

**LMOD4**....Modular type plug, 4 conductor, RJ22



**LMOD6**....Modular Type Plug, 8 conductor, RJ11



**LMOD8**....Modular Type, 8 Conductor, RJ45 / RJ48



**LO**....Miniature alligator clips (Mueller #30) ; (one pair: red /black)



**LS**....Step switch space lug



**LX**....Porta (Plugs into test field)



**LBIX**....Bix connector (QTBIX17-NT)



**LMG**....Mini Grabbers (one pair: red /black)



**LNAN**....Banana Plug



**LOE**....Northern Telecom Original Equipment



**LSLC5**....SLC-5 Plug



Ph: 1-800-526-2673

[www.westek.com](http://www.westek.com)

Fax: 1-800-526-3299



## Choose Components continued...

**310...310 Plug**



**L3M...3M Binding Post Clip**



**L4....463A (Replaces 5 Pin Protector)**



**L4WO....L4 (without ground pin, looks in and out)**



**L5....P2FM Equivalent (AT&T 310 and 311)**



**L6....Large Chuck ends (adapter 360 Tool) ; (one pair: red /black)**



**L7.... Chuck Ends (over wire wrap pins) ; (one pair: red /black)**



**L8....Porta (replaces protector)**



**L9....Porta (plugs into protector)**



**L96....SLC-96 Plug (equivalent to mini-plug)**



**LDBAN....Dual Bantam Plug**



# Combi-Cord Ends

**L1**....Alligator Clips (Mueller #60)



**L110**....AT&T 110 Connector Plug



**L110D**....110 D Test Connector



**L2**....453A or P2EF equivalent (AT&T 303 & 309-NT 377)



**L284**....Amphenol 284-1 Plug for 66 Block



**L299**...Plugs into NT 399 Block



**L3**....526A (Plugs into 4C Type Protector)



**LHTCAB**...Heavy Test Clips, Angle Nose, Bed of nails ; (one pair: red /black)



**LHTCAP**....Heavy Test Clip, Angle Nose, Single Pin ; (one pair: red /black)



Ph: 1-800-526-2673



[www.westek.com](http://www.westek.com)

Fax: 1-800-526-3299

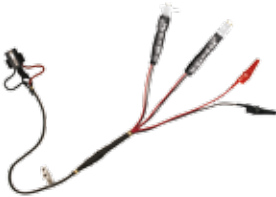
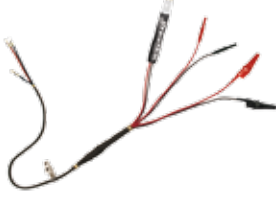
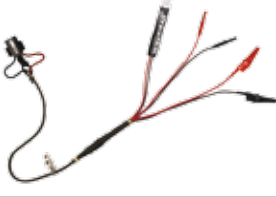
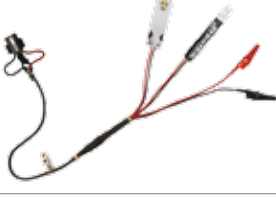
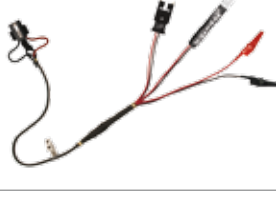
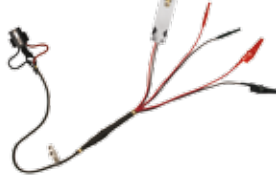
# Combi-Cords

	PID #	Description	Part #
	ATT.100031451	B2, C3, L1, L2, L5	TC 23125
	ATT.100067309	B1, C3, L1, L2, L7	TC 13127
	ATT.100067310	B2, C3, L1, L2, L7	TC 23127
	ATT.100067311	B2, C3, L1, L2, L3	TC 23123
	ATT.100067312	B2, C3, L1, L2, L9	TC 23129
	ATT.100067313	B2, C3, L1, L3, L7	TC 23137

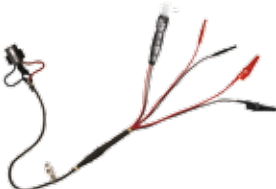
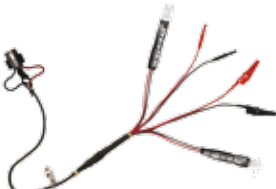
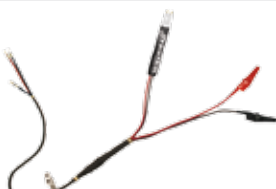
# Combi-Cords

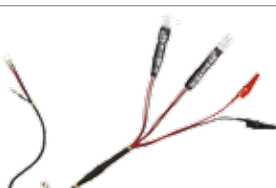
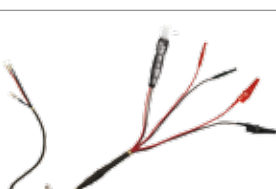

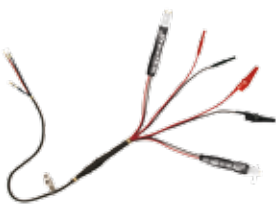
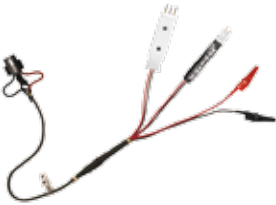
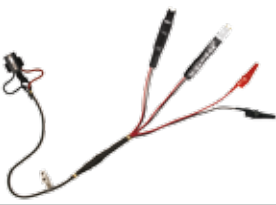
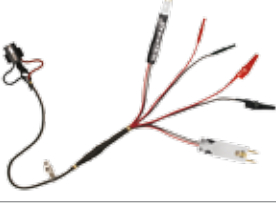
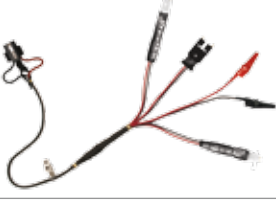
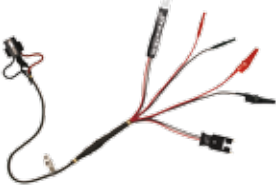

	PID #	Description	Part #
	ATT.100067314	B2, C3, L1, L5, L7	TC 23157
	ATT.100043519	B2, C4, L1, L2, L5, L7	TC 241257
	ATT.100075585	B1, C2, L1, L2	TC 1212
	ATT.100067315	B1, C2, L1, L3	TC 1213
	ATT.100067316	B1, C3, L1, L2, L5	TC 13125
	ATT.100067317	B1, C3, L1, L5, L7	TC 13157

# Combi-Cords

	PID #	Description	Part #
	ATT.100067319	B1, C4, L1, L2, L5, L7	TC 141257
	ATT.100067338	B2, C3, L1, L2, L4	TC 23124
	ATT.100067339	B2, C3, L1, L2, LX	TC 2312X
	ATT.100067340	B2, C4, L1, L2, L3, L7	TC 241237
	ATT.100067341	B2, C4, L1, L2, L5, L9	TC 241259
	ATT.100067342	B2, C4, L1, L2, L7, L9	TC 241279

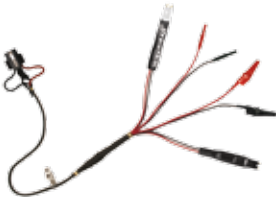
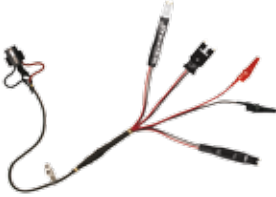
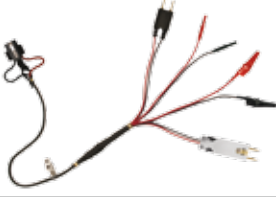

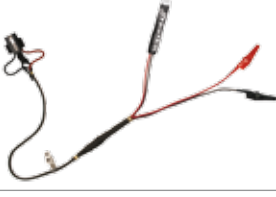

# Combi-Cords

	<b>PID #</b>	<b>Description</b>	<b>Part #</b>
	ATT.100034520	B2, C4, L1, L2, L7, LX	TC 24127X
	ATT.100031454	B2, C4, L1, L2, L9, LX	TC 24129X
	ATT.100038219	B2, C4, L1, L3, L7, LSLC96	TC 24137Z
	ATT.100067333	B2, C1, LHTBP	TC 21R
	ATT.100067334	B2, C2, L1, L2	TC 2212
	ATT.100067335	B2, C2, L1, L3	TC 2213

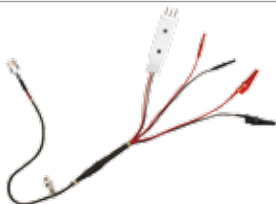
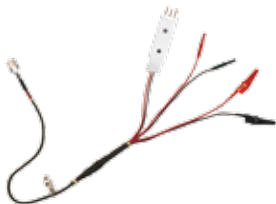
# Combi-Cords

	PID #	Description	Part #
	ATT.100084052	ADSL Modem Test Cord RJ11 (pins 2,5), C3, L1, L4, L7 Looking in 12' Cord	TC-XL5PL7
	ATT.1000????	ADSL Modem Test Cord RJ45 (pins 3,6), C3, L1, L4, L7 Looking in 12' Cord	TC-XL5PL745/12

# Buttset Replacement Cords

	PID #	Description	Part #
	ATT.100011861	Hardwires to TS-44 and TS52 Buttset w/ RJ11 to plug direct to wall jacks, or residential Network Interface	TC-162202
	ATT.100050955	Hardwires to TS-22 Buttset w/ RJ11 to plug direct to wall jacks, or residential Network Interface	TC-162209

**NEW FROM WESTEK**



Patent Pending



*OSP / CO Hybrid Combi-Cord*

Introducing the newest solution for the OSP/CO  
*TC-HYBNRU*

**ATT. 100089797**

Many OSP techs have the necessity to test at unmanned COs. The new Outside Plant Combi-Cord is designed to give these technicians what they need to service the CO during unmanned hours/days. The response from the field was to make a cord with CO components for quick access, with Westek's proven OSP cord durability. With this valuable insight we designed the Hybrid cord for reliable utility when it's needed most.

**Put testing excellence in your hands.**

Inquire with your Westek Regional Service Manager.

**800.526.2673**

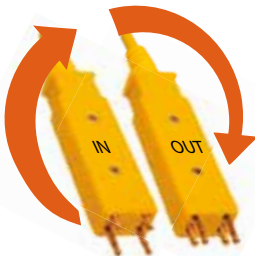

Look in to CO with the 5 pin 463A  
Turn 180 degrees to look out to the field

**TC-HYBNRU**  
Clip Access/RJ11  
L7 Chuck Ends  
5 Pin 463A  
P2FM  
P2EF

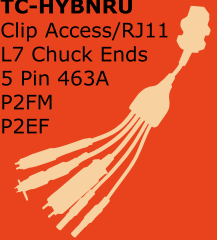

Ph: 1-800-526-2673

[www.westek.com](http://www.westek.com)

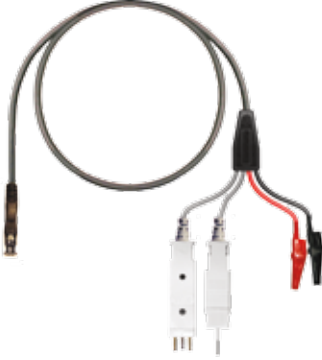

Fax: 1-800-526-3299

# Smart Class Cord

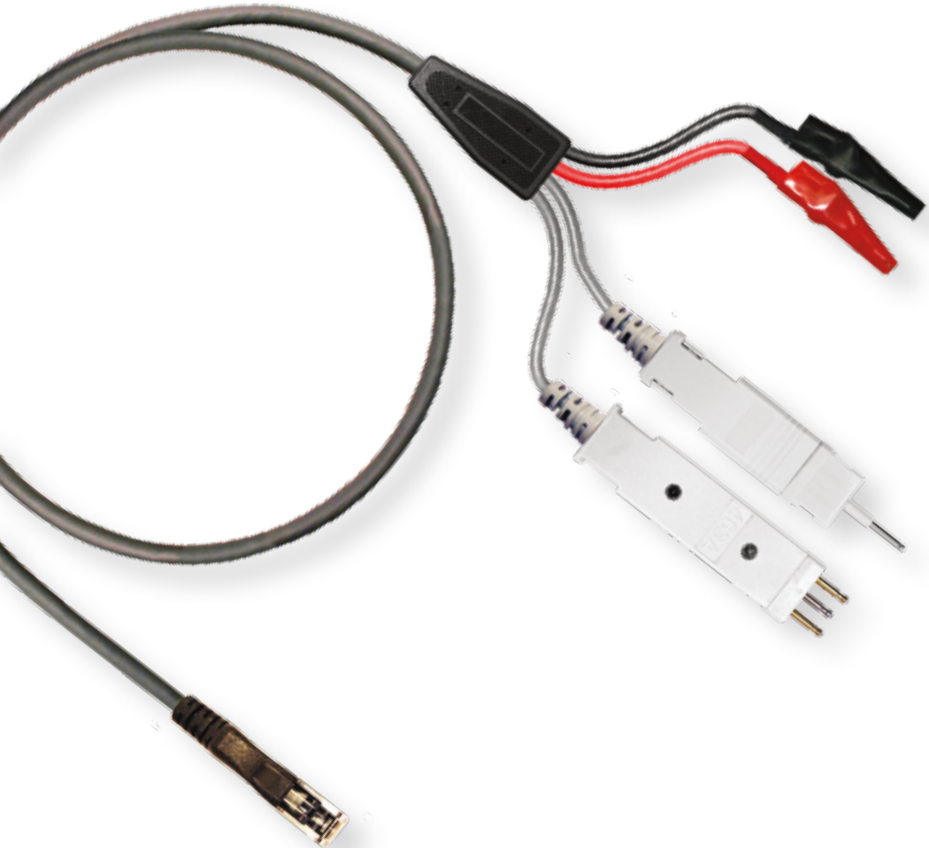
	PID #	Description	Part #
	ATT.100051732	Smart Class Cord RJ11 to Y 463A, Porta & (2) Alligator 6'	TC-153104/6



# Testers

	PID #	Description	Part #
 <p>Protector Not Included</p>	ATT.100011765	Tel-Line Tester Pro Kit Includes Looping Tool and Grounding Tool	KT 291052
 <p>Protector Not Included</p>	ATT.100011483	Tel-Line Tester Pro Tester Only	TC-TLTS-PRO
	ATT.100416850	TLTS Extension Cord	TC-L4PEXT/30"
	ATT.10041190	300 Series Adapter	TC-AD300



# Testers

	PID #	Description	Part #
	ATT.100066060	Tel-Line Tester only	TC-TLTS 1A
	ATT.100067508	Porta Tel-Line Tester	TC-TLTS 1P
	ATT.100400650	Tel-Line Tester Kit	TC-TLTS-2
	ATT.100066059	Accessory Kit for Tel-Line Tester	KT 290407
	ATT.100067419	Tel-Line Tester Kit with Bag	TC-TLTS2C

# Bantam Cords



	<b>PID #</b>	<b>Description</b>	<b>Part #</b>
	ATT.100067321	Bantam to Bantam 1' Cord	TC-200/1
	ATT.100067323	Bantam to Bantam 2' Cord	TC-200/2
	ATT.100067324	Bantam to Bantam 3' Cord	TC-200/3
	ATT.100074973	Bantam to Bantam 4' Cord	TC-200/4
	ATT.100067325	Bantam to Bantam 5' Cord	TC-200/5
	ATT.100067326	Bantam to Bantam 6' Cord	TC-200/6
	ATT.100067320	Bantam to Bantam 8' Cord	TC-200
	ATT.100067322	Bantam to Bantam 12' Cord	TC-200/12
	ATT.100074990	Bantam to Bantam 18' Cord	TC-200/18
	ATT.100067327	Bantam to Bantam 20' Cord	TC-200/20
	ATT.100000635	Bantam to Bantam 24' Cord	TC-200/24
	ATT.100067328	Bantam to Bantam 25' Cord	TC-200/25
	ATT.100067329	Bantam to Bantam 30' Cord	TC-200/30
	ATT.100067330	Bantam to Bantam 40' Cord	TC-200/40
	ATT.100067331	Bantam to Bantam 50' Cord	TC-200/50

# Bantam Cords





	<b>PID #</b>	<b>Description</b>	<b>Part #</b>
	ATT.100074942	Bantam to 310 4' Cord	TC-230/4
	ATT.100074943	Bantam to 310 6' Cord	TC-230/6
	ATT.100067336	Bantam to 310 8' Cord	TC-230
	ATT.100067337	Bantam to 310 10' Cord	TC-230/10
	ATT.100074955	Bantam to 310 12' Cord	TC-230/12
	ATT.100031452	Bantam to 310 20' Cord	TC-230/20
	ATT.100074991	Dual Bantam to Dual Bantam 3 Conductor, 1' Cord	TC-250/1
	ATT.100074850	Dual Bantam to Dual Bantam 3 Conductor, 5' Cord	TC-250/5
	ATT.100062893	Dual Bantam to Dual Bantam 3 Conductor, 6' Cord	TC-250/6
	ATT.100067344	Dual Bantam to Dual Bantam 3 Conductor, 8' Cord	TC-250
	ATT.100067345	Dual Bantam to Dual Bantam 3 Conductor, 10' Cord	TC-250/10
	ATT.100067346	Dual Bantam to Dual Bantam 3 Conductor, 12' Cord	TC-250/12
	ATT.100062881	Dual Bantam to Dual Bantam 3 Conductor, 25' Cord	TC-250/25

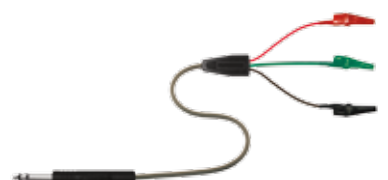

# Bantam Cords

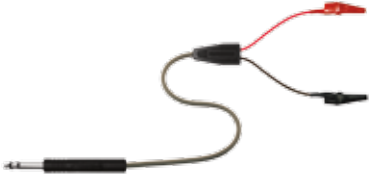
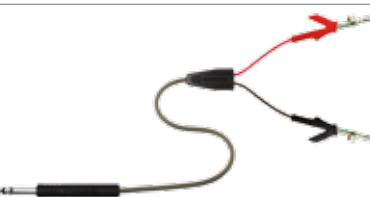
	<b>PID #</b>	<b>Description</b>	<b>Part #</b>
	ATT.100067347	Dual Bantam to Dual Bantam 3 Conductor, 15' Cord	TC-250/15
	ATT.100038242	Dual Bantam to Dual Bantam 3 Conductor, 20' Cord	TC-250/20
	ATT.100000751	Dual Bantam to Dual Bantam 3 Conductor, 24' Cord	TC-250/24
	ATT.100414750	Dual Bantam to Dual Bantam 3 Conductor, 45' Cord	TC-250/45
	ATT.100069766	Dual Bantam to Dual Bantam 3 Conductor, 50' Cord	TC-250/50
	ATT.100067348	Dual Bantam to Alligator Clips 8' Cord	TC-256
	ATT.100067349	Dual Bantam to 4 Alligator Clips 8' Cord	TC-256(4)
	ATT.100067350	Bantam to 3 Alligator Clips 8' Cord	TC-260(3)

# Bantam Cords

	<b>PID #</b>	<b>Description</b>	<b>Part #</b>
	ATT.100031456	Bantam to Alligator Clips, 5' Cord	TC-260/5
	ATT.100067351	Bantam to Alligator Clips, 8' Cord	TC-260
	ATT.100067352	Bantam to Alligator Clips, 12' Cord	TC-260/12
	ATT.100031455	Bantam to Alligator Clips, 16' Cord	TC-260/16
	ATT.100067354	Bantam to Heavy Test Clip, Bed of Nails & pin	TC-260LTBP
	ATT.100031446	8' Cord 20" Cord	TC-260LTBP/20
	ATT.100067355	Bantam to 66 Block 8' Cord	TC-266
	ATT.100038213	Bantam to Wire Wraps	TC-272/6
	ATT.100067356	6' Cord 8' Cord	TC-272
	ATT.100067357	Dual Bantam to Dual 310, 8' Cord	TC-290
	ATT.100038240	Dual Bantam to Dual 310, 10' Cord	TC-290/12
	ATT.100062566	Dual Bantam to Dual 310, 12' Cord	TC-290/12
	ATT.100067358	Dual Bantam to Dual 310, 20' Cord	TC-290/20
	817 917 722	Dual Bantam to Dual 310, 24' Cord	TC-290/24
	ATT.100067359	Dual Bantam to Dual 310, 30' Cord	TC-290/30

# Bantam Cords



	<b>PID #</b>	<b>Description</b>	<b>Part #</b>
	301 056 511	Dual Bantam to 360 Tools 8' Cord	TC-292
	ATT.100067360	Dual Bantam to 360 Tools 16' Cord	TC-292/16
	ATT.100067332	Bantam to Female 310 8' Cord	TC-203S
	ATT.100031453	Bantam to Minigrabbers 8' Cord	TC-240/8
	352 972 129	Right Angle Bantam to Right Angle Bantam 2' Cord	TC-200(RA)
	241 013 309	Bantam to 3 pin DIN 15' Cord	TC 16814/15
	237 013 305	Dual Bantam to Female 310 1' Blue Cord	TC-227ATX/1
	238 013 304	Dual Bantam to Female 310 1' Red Cord	TC-227ARX/1

Ph: 1-800-526-2673









[www.westek.com](http://www.westek.com)

Fax: 1-800-526-3299



# 310 Cords

	<b>PID #</b>	<b>Description</b>	<b>Part #</b>
	ATT.100067368	310 to 310 1' Cord	TC-310/1
	ATT.100067387	310 to 310 2' Cord	TC-310/2
	ATT.100067407	310 to 310 6' Cord	TC-310/6
	ATT.100067388	310 to 310 8' Cord	TC-310
	ATT.100067385	310 to 310 10' Cord	TC-310/10
	ATT.100067386	310 to 310 12' Cord	TC-310/12
	301 056 560	310 to 310 2 conductor, 1' Cord	TC-310-2/1
	301 056 586	310 to 310 2 conductor, 2' Cord	TC-310-2/2
	ATT.100067367	310 to 310 2 conductor, 6' Cord	TC-310-2/6
	ATT.100067365	310 to 310 2 conductor, 10' Cord	TC-310-2/10
	301 056 859	Dual 310 to Dual 310 2' Cord	TC-350/2
	ATT.100067392	Dual 310 to Dual 310 6' Cord	TC-350/6
	ATT.100017415	Dual 310 to Dual 310 8' Cord	TC-350
	ATT.100067390	Dual 310 to Dual 310 10' Cord	TC-350/10
	ATT.1000	Dual 310 to Dual 310 12' Cord	TC-350/12
	ATT.100078273	Dual 310 to Dual 310 20' Cord	TC-350/20
	812 991 727	Dual 310 to Dual 310 24' Cord	TC-350/24

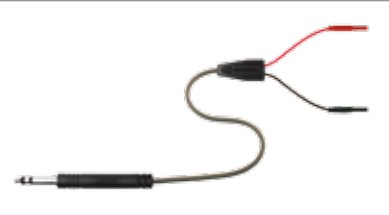

# 310 Cords

	<b>PID #</b>	<b>Description</b>	<b>Part #</b>
	ATT.100067397	Dual 310 to Bantam 8' Cord	TC-354
	ATT.100067398	Dual 310 to Bantam 2 conductor, 8' Cord	TC-354/15
	ATT.100067400	Dual 310 to Alligator Clips 8' Cord	TC-356
	ATT.100067401	Dual 310 to 4 Alligator Clips 8' Cord	TC-356(4)
	ATT.100067403	310 to Alligator Clips 6' Cord	TC-360/6
	ATT.10000661	310 to Alligator Clips 8' Cord	TC-360
	ATT.100067402	310 to Alligator Clips 12' Cord	TC-360/12
	ATT.100014367	310 to 3 Alligator Clips 12' Cord	TC-360(3)/12

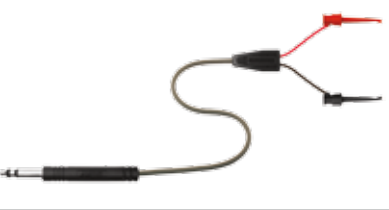



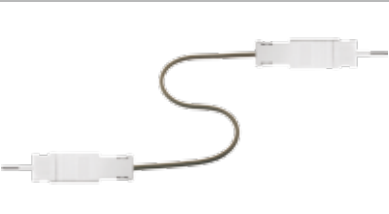

# 310 Cords

	<b>PID #</b>	<b>Description</b>	<b>Part #</b>
	684 940 877	310 to 360 Tools 8' Cord	TC-372
	ATT.100000631	310 to RJ45 8' Cord	TC-348
	ATT.100000741	310 to Minigrabbers 8' Cord	TC-340

# Porta Cords

	<b>PID #</b>	<b>Description</b>	<b>Part #</b>
	301 056 883	Porta to Porta 8' Cord	TC-L8L8
	ATT.100067394	Porta to Porta Looping 8' Cord	TC-L8LOOP

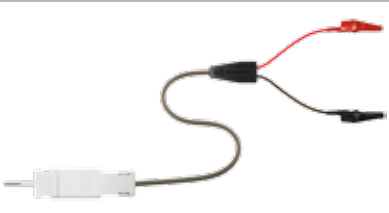
# Porta Cords





	<b>PID #</b>	<b>Description</b>	<b>Part #</b>
	ATT.100067395	Porta to Porta Frogging 8' Cord	TC-L8FROG
	ATT.100067396	Porta Good Shoe/ Bad Shoe with Protection 8' Cord	TC-L8GBP
	ATT.100067427	Porta to Bantam 8' Cord	TC-L8200
	ATT.100067428	Porta to Dual Bantam 8' Cord	TC-L8250
	ATT.100067429	Porta to Dual Bantam 16' Cord	TC-L8250/16
	ATT.100067430	Porta to Dual 310 8' Cord	TC-L8350
	ATT.100067431	Porta to Alligator Clips 8' Cord	TC-L8600

Ph: 1-800-526-2673



[www.westek.com](http://www.westek.com)

Fax: 1-800-526-3299

## Porta Cords



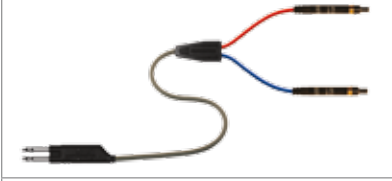

	<b>PID #</b>	<b>Description</b>	<b>Part #</b>
	ATT.100067433	Porta (L9) to Bantam 8' Cord	TC-L9200
	301 057 345	Porta (L9) to Dual Bantam 8' Cord	TC-L9250
	ATT.100067435	Porta (L9) to Alligator Clips 8' Cord	TC-L9600
	ATT.100067442	Porta (LX) to Alligator Clips 8' Cord	TC-LX600

## 410 Cords

	<b>PID #</b>	<b>Description</b>	<b>Part #</b>
	ATT.100414770	Dual Bantam to 412 Plugs	D1 250148
	ATT.100072529	Female (L4) to 412 Plugs	TC-162235



# 463A Cords

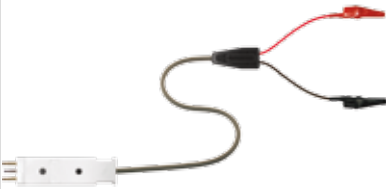



	PID #	Description	Part #
	ATT.100067371	463A to 463A Frogging 10' Cord	T C - 5PFROG/10
	ATT.100067372	463A to 463A Frogging 25' Cord	T C - 5PFROG/25
	ATT.100067378	463A to 463A Looping 8' Cord	TC-5PLOOP
	ATT.100067374	463A to Bantam 8' Cord	TC-5P200
	ATT.100000683	463A to Bantam 8' Blue Cord	TC-5P200TX
	ATT.100067375	463A to Dual Bantam 8' Cord	TC-5P250
	ATT.100000703	463A to Dual Bantam 8' Blue Cord	TC-5P250TX
	ATT.100067376	463A to 310 8' Cord	TC-5P310
	ATT.100068893	463A to Alligator Clips 3' Cord	TC-5P600/3
	ATT.100067377	8' Cord	TC-5P600
	ATT.100000793	16' Cord	TC-5P600/16

Ph: 1-800-526-2673



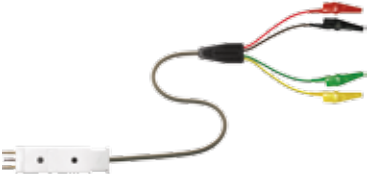

Fax: 1-800-526-3299

[www.westek.com](http://www.westek.com)



# 463A Cords

	<b>PID #</b>	<b>Description</b>	<b>Part #</b>
	ATT.100000687	463A to 463A 10' Cord	TC-463A/10
	760 933 499	463A to 463A 16' Cord	TC-W111/16
	ATT.100000767	463A to 4 Alligator Clips 16' Cord	TC-5P600(4)
	ATT.100000795	463A to 4 Round Lugs 16' Cord	TC-5P700(4)
	ATT.100000789	463A to Y 310 8' Cord	TC-5PTR310







# Coax Cords

	<b>PID #</b>	<b>Description</b>	<b>Part #</b>
	ATT.100067421	440A to 440A 8' Red Cord	TC-440A/RX
	ATT.100067369	440A to 440A 8' Blue Cord	TC-440A/TX
	ATT.100067370	358A to 440A 8' Red Cord	TC-458ARX
	ATT.100067505	358A to 440A 8' Blue Cord	TC-458ATX
	ATT.100067500	440A to 440A 1' Cord	TC-440A/1
	ATT.100068109	2' Cord	TC-440A/2
	ATT.100067498	6' Cord	TC-440A/6
	ATT.100067499	8' Cord	TC-440A
	ATT.100066229	10' Cord	TC-440A/10
	ATT.100031446	12' Cord	TC-440A/12
	616 992 814	15' Cord	TC-440A/15
ATT.100068114	30' Cord	TC-440A/30	
	301 058 228	BNC to BNC Kings 1' Cord	TC-500KNG/1
	301 058 210	BNC to BNC Kings 8' Cord	TC-500-KNG
	ATT.100031458	358A to 358A 1' Cord	TC-358A/1
	ATT.100031459	358A to 358A 8' Cord	TC-358A



# Coax Cords

	PID #	Description	Part #
		440D to BNC Kings 8' Cord	TC-540D
	ATT.100067513	Dual 440D to Dual 440A, Kings 6 inch Cord	TC-D444T/6"
	ATT.100067514	Dual 440D to Dual 440A, Kings 1' Cord	TC-D444T/1
	ATT.100067514	Dual 440D to Dual 440A, Kings 2' Cord	TC-D444T/2
	ATT.100067515	Dual 440D to Dual 440A, Kings 3' Cord	TC-D444T/3
	ATT.100067516	Dual 440D to Dual 440A, Kings 4' Cord	TC-D444T/4
	ATT.100067516	Dual 440D to Dual 440A, Kings 5' Cord	TC-D444T/5
	ATT.100067512	Dual 440D to Dual 440A, Kings 6' Cord	TC-D444T/6
	ATT.100067455	Dual 440D to Dual 440A, Kings 8' Cord	TC-D444T/8
	ATT.100067456	Dual 440D to Dual 440A, Kings 10' Cord	TC-D444T/10
	ATT.100067457	Dual 440D to Dual 440A, Kings 14' Cord	TC-D444T/14





# Coax Cords

	<b>PID #</b>	<b>Description</b>	<b>Part #</b>
	ATT.100067511	440D to 440A Kings 8' Cord	TC-444
	ATT.100067510	440D to 358A Kings 8' Cord	TC-458D
	ATT.100068121 ATT.100068122 ATT.100068123 ATT.100068124 ATT.100066230 ATT.100068125 ATT.100068126 ATT.100068127	358A to 440A  1' Cord 2' Cord 3' Cord 6' Cord 10' Cord 12' Cord 20' Cord 25' Cord	TC-458A/1 TC-458A/2 TC-458A/3 TC-458A/6 TC-458A/10 TC-458A/12 TC-458A/20 TC-458A/25
		440D to 440D Kings 8' Cord	TC-440D
		BNC to 440A 8' Cord	TC-540
		BNC to BNC 8' Red Cord	TC-500RX
		BNC to BNC 8' Blue Cord	TC-500TX





# Coax Cords

	<b>PID #</b>	<b>Description</b>	<b>Part #</b>	
	335 100 558	BNC to BNC 6' Cord	TC-500/6	
	336 000 559	BNC to BNC 12' Cord	TC-500/12	
		Dual BNC to Dual BNC with Tracer		
	580 022 986	6" Cord	TC-D500T/6"	
	209 013 309	2' Cord	TC-D500T/2	
	339 000 556	4' Cord	TC-D500T/4	
	340 000 553	6' Cord	TC-D500T/6	
	459 002 143	8' Cord	TC-D500T/8	
	460 002 140	10' Cord	TC-D500T/10	
	341 100 550	12' Cord	TC-D500T/12	
	461 002 149	15' Cord	TC-D500T/15	
	462 002 148	20' Cord	TC-D500T/20	
	464 002 146	26' Cord	TC-D500T/26	
	593 022 981	Custom Length	TC-D500T/XX	
		Dual 440D to Dual 440D with Tracer		
	301 064 598	6" Cord	TC-D452T/6"	
	301 064 655	1' Cord	TC-D452T/1	
	ATT.100007045	2' Cord	TC-D452T/2	
	ATT.100038234	4' Cord	TC-D452T/4	
	ATT.100007097	6' Cord	TC-D452T/6	
	ATT.100007063	8' Cord	TC-D452T/8	
	ATT.100007065	10' Cord	TC-D452T/10	
	ATT.100007067	12' Cord	TC-D452T/12	
	ATT.100017416	14' Cord	TC-D452T/14	
	ATT.100007071	16' Cord	TC-D452T/16	
	301 067 757	18' Cord	TC-D452T/18	
	ATT.100007077	20' Cord	TC-D452T/20	
	ATT.100007103	22' Cord	TC-D452T/22	
	ATT.100007101	24' Cord	TC-D452T/24	
	ATT.100038232	26' Cord	TC-D452T/26	
	400 155 669	28' Cord	TC-D452T/28	
	ATT.100007079	30' Cord	TC-D452T/30	
	400 155 677	32' Cord	TC-D452T/32	
	301 067 997	34' Cord	TC-D452T/34	
	ATT.100007105	35' Cord	TC-D452T/35	
	400 155 685	36' Cord	TC-D452T/36	
	301 068 045	38' Cord	TC-D452T/38	
	400 155 693	40' Cord	TC-D452T/40	
	301 068 102	42' Cord	TC-D452T/42	
		Call for custom cord lengths up to 90'		

# Coax Cords



	<b>PID #</b>	<b>Description</b>	<b>Part #</b>
	ATT.100002509 223 012 301 224 013 300 225 013 309 912 012 085 913 012 084 914 012 083 915 012 082 916 012 081 ATT.100014869 918 012 089 ATT.100014871 595 022 989	Dual BNC to Dual 440D with Tracer  6" Cord 2' Cord 4' Cord 6' Cord 8' Cord 10' Cord 12' Cord 16' Cord 18' Cord 20' Cord 26' Cord 30' Cord Custom Length	TC-D552T/6" TC-D552T/2 TC-D552T/4 TC-D552T/6 TC-D552T TC-D552T/10 TC-D552T/12 TC-D552T/16 TC-D552T/18 TC-D552T/20 TC-D552T/26 TC-D552T/30 TC-D552T/XX
	ATT.100038269 ATT.10000933 ATT.100038270 955 012 083 ATT.100038265 957 012 081 958 012 080 ATT.100038267 ATT.100038268 960 012 086	LCP to LCP  3" Cord 6" Cord 8' Cord 10' Cord 12' Cord 16' Cord 18' Cord 20' Cord 27' Cord 30' Cord	TC-LCP/3 TC-LCP/6 TC-LCP/8 TC-LCP/10 TC-LCP/12 TC-LCP/16 TC-LCP/18 TC-LCP/20 TC-LCP/27 TC-LCP/30
	ATT.100053138 940 012 081 ATT.10000863 942 012 089	LCP to 440A  6' Cord 8' Cord 10' Cord 12' Cord	TC-445/6 TC-445 TC-445/10 TC-445/12
	938 012 085	LCC to BNC 8' Cord	TC-531/8

# Coax Cords





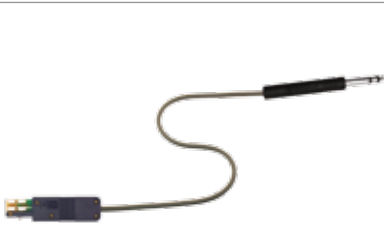
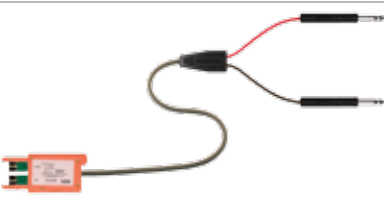
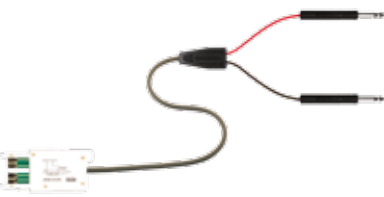

	PID #	Description	Part #
	961 012 085 962 012 084 ATT.100039933 964 012 082 965 012 081 966 012 080 967 012 089 968 012 088	LCC to LCC  8' Cord 10' Cord 12' Cord 16' Cord 18' Cord 20' Cord 26' Cord 30' Cord	TC-LCC/8 TC-LCC/10 TC-LCC/12 TC-LCC/16 TC-LCC/18 TC-LCC/20 TC-LCC/26 TC-LCC/30
	249 013 301 250 013 307 251 012 306 252 013 305	LCC to 440A  6' Cord 8' Cord 10' Cord 12' Cord	TC-440ALCC/6 TC-440ALCC TC-440ALCC/10 TC-440ALCC/12
	923 012 082 924 012 081 925 012 080 926 012 089 927 012 088 928 012 087 929 012 086 930 012 083 932 012 081 933 012 080	Dual LCC to Dual LCC with Tracer  4' Cord 6' Cord 8' Cord 10' Cord 12' Cord 16' Cord 18' Cord 20' Cord 30' Cord 34' Cord	TC-DLCCT/4 TC-DLCCT/6 TC-DLCCT TC-DLCCT/10 TC-DLCCT/12 TC-DLCCT/16 TC-DLCCT/18 TC-DLCCT/20 TC-DLCCT/30 TC-DLCCT/34
	943 012 088 944 012 087 945 012 089 946 012 085 947 012 084 948 012 083 949 012 082 950 012 088 951 012 087 952 012 086	Dual 440 to Dual LCC with Tracer  8' Cord 10' Cord 15' Cord 20' Cord 25' Cord 30' Cord 35' Cord 40' Cord 45' Cord 50' Cord	TC-D652T/8 TC-D652T/10 TC-D652T/15 TC-D652T/20 TC-D652T/25 TC-D652T/30 TC-D652T/35 TC-D652T/40 TC-D652T/45 TC-D652T/50





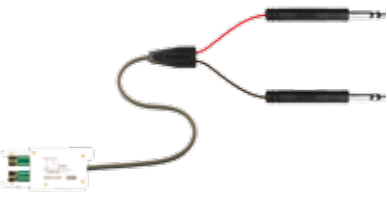
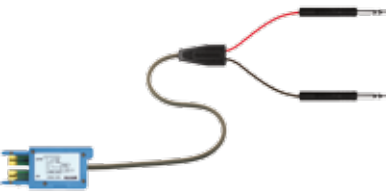



# 800 DSX Cords

	<b>PID #</b>	<b>Description</b>	<b>Part #</b>
	ATT.100067486	800 Simplex to 800 Simplex 6' Cord	TC-800/6
	ATT.100067487	800 Simplex to 800 Simplex 12' Cord	TC-800
	ATT.100067488	800 Duplex to 800 Duplex 6' Cord	TC-850/6
	240 013 300	800 Duplex to 800 Duplex 10' Cord	TC-850/10
	766 900 476	800 Duplex to 800 Duplex 12' Cord	TC-850
	ATT.100000771	800 Simplex to Bantam 6' Cord	TC-820
	ATT.100067489	800 Simplex to Bantam 10' Cord	TC-820/10
	ATT.100067490	800 Simplex to Bantam 12' Cord	TC-820/12
	ATT.100067491	800 Duplex Orange to Y Bantam 12' Cord	TC-8230/12
	422 950 592	800 Duplex White to Y Bantam 6' Cord	TC-823W/6
	ATT.100067492	800 Duplex White to Y Bantam 12' Cord	TC-823W/12

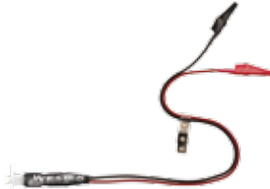
# 800 DSX Cords

	<b>PID #</b>	<b>Description</b>	<b>Part #</b>
	ATT.100031449	800 Simplex to 310 12' Cord	TC-830/6
	ATT.100067494	800 Simplex to 310 12' Cord	TC-830/12
	425 950 599	800 Duplex White to Y 310 6' Cord	TC-833W/6
	978 012 086	800 Duplex Blue to Y Bantam 6' Cord	TC-823B/6
	ATT.100067493	800 Duplex Blue to Y Bantam 12' Cord	TC-823B/12
	244 013 306	800 Duplex Blue to 800 Duplex White 50' Cord	TC 16820/50
	ATT.100000605	800 Duplex Yellow Looping Plug	TC-LP800

# AT&T Replacement Cords





	<b>PID #</b>	<b>Description</b>	<b>Part #</b>
	ATT.100001409	453A to Alligator Clips 16" Red/Black Cord	TC-P2EF
	ATT.100000629	L5 to Alligator Clips 16" Red/Black Cord	TC-P2FM
	ATT.100000615	526A to Alligator Clips 16" Red/Black Cord	TC-P2FL
	ATT.100067318	RJ48 to RJ48 10' Royal Blue Cord	TC-140
	ATT.100067362	310 to 360 Tools 6' Cord	TC-2W17A
	301 057 550	471A to Alligator Clips 3' Cord	TC-2W37A/3
	ATT.100067363	471A to Alligator Clips 4" 5" Cord	TC-2W37A

Ph: 1-800-526-2673



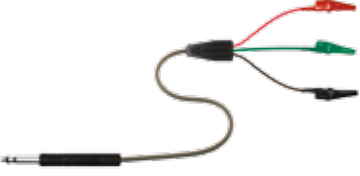
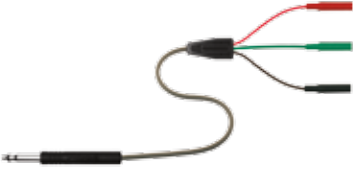

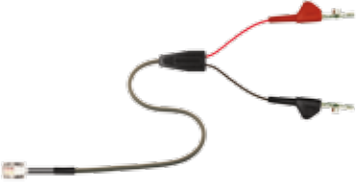
[www.westek.com](http://www.westek.com)

Fax: 1-800-526-3299

# AT&T Replacement Cords

	<b>PID #</b>	<b>Description</b>	<b>Part #</b>
	301 057 055	471A to Alligator Clips with 2k ohms resistor switch	TC-3W10A
	301 057 063	310 to 3 Alligator Clips 4' Cord	TC-3W3A/4
	301 057 071	310 to 3 Alligator Clips 12' Cord	TC-3W3A/12
	ATT.100067420	310 to 360 Tools 6' Cord	TC-3W4A
	ATT.100067379	RJ11 to Alligator Clips 5' Cord	TC-611/5
	ATT.100067381	RJ11 to Heavy Test Clips, with Bed of Nails and Pin 5' Cord	TC-611LTBP/5
	ATT.100067380	8' Cord	TC-611LTBP/8
	ATT.100067382	Castle to 526A and 463A 10' Cord	TC-6W3D

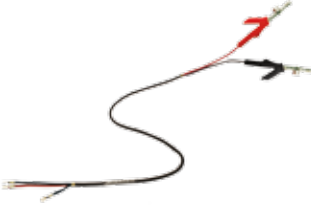
# AT&T Replacement Cords





	<b>PID #</b>	<b>Description</b>	<b>Part #</b>
	ATT.100031465 ATT.100031457	Minigrabber to Minigrabber  3' Cord 6' Cord	TC-700/3 TC-700/6
	ATT.100067425	Dual Bantam to 463A and Porta 16' Cord	TC-CS01
	ATT.100067426	463A to 463A with Protector Cradle 10' Cord	TC-GBP
	ATT.100067404	Hardwire Lugs to Heavy Test Clip with Bed of Nails 5' Cord	TC-H2B-LTB
	ATT.100067405	Hardwire Lugs to Quick Disconnect 346A 16" Cord	TC-H2C
	ATT.100067446	Quick Disconnect 471A to 453A	TC-P2EU

Ph: 1-800-526-2673



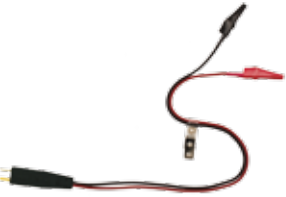

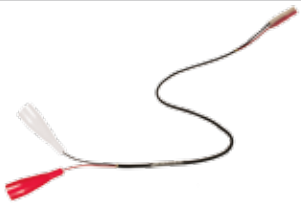

[www.westek.com](http://www.westek.com)

Fax: 1-800-526-3299

# AT&T Replacement Cords

	PID #	Description	Part #
	ATT.100067452	SLC5 to Alligator Clips 16" Cord	TC-SLC5
	ATT.100067460 ATT.100067464 ATT.100067466	Y 463A and Porta to Y 463A and Porta Good Shoe/Bad Shoe with Protection	TC-W111-2P/10 TC-W111-2P/16 TC-W111-2P/25
	ATT.100067468 ATT.100067465 ATT.100067467	463A to 463A Good Shoe/Bad Shoe with Protection	TC-W111-1P/8 TC-W111-1P/16 TC-W111-1P/25
	ATT.100067474	Alligator clips with #26 Boots to 360 Tools 16" Cord	TC-W2FH
	ATT.100067471 ATT.100067472	Wire Wrap to Wire Wrap 2' Green Cord  Wire Wrap to Wire Wrap 3.5' Green Cord	TC-W1AL  TC-W1AL/3.5

# AT&T Replacement Cords







	<b>PID #</b>	<b>Description</b>	<b>Part #</b>
	ATT.100067444	110D to Round Lugs 8' Cord	TC-P2E6A
	301 057 865	20 amp Clip to 20 amp Clip Coiled Cord 25' stretched	TC-W1BU
	ATT.100067469	5 amp Clip to Hardwire Lugs 6' Cord	TC-W1AH
	ATT.100067473	Quick Disconnect 471A to 360 Tools 4' Cord	TC-W2CJ
	ATT.100001415	463A to Alligator clips with Red & White #26 Boots 4.5' Cord	TC-W2GL
	ATT.100067475	463A to Alligator clips with Red & Black #26 Boots 4.5' Cord	TC-W2GC

Ph: 1-800-526-2673

[www.westek.com](http://www.westek.com)







Fax: 1-800-526-3299

# AT&T Replacement Cords

	PID #	Description	Part #
	301 057 923	327 Plug to 360 Tools 16" Cord	TC-W2FM/16
	ATT.100067478	463A without ground pin to Alligator Clips 16" Cord	TC-W463EF
	ATT.100067479	463A to 327 Plug 16' Black Cord	TC-W4BR
	ATT.100067480	463A to 327 Plug 16' Gray Cord	TC-W4CJ
	ATT.100067481	327 Plug to "Y" 463A and 463A 16' Cord	TC-W4CM
	ATT.100067482	Dual Bantam (2 Conductor) to 463A (special wiring) 16' Cord	TC-W4CP



# AT&T Replacement Cords

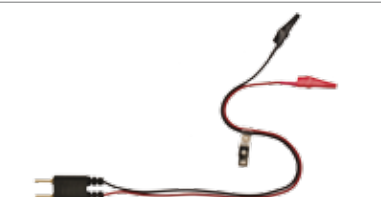





	<b>PID #</b>	<b>Description</b>	<b>Part #</b>
	ATT.100067483	Dual Bantam (2 Conductor) to 463A 16' Cord	TC-W4CT
	ATT.100067484	463A to 125BW 10' Cord	TC-W4DG/10
	ATT.100067485	463A to 125BW 16' Cord	TC-W4DG
	ATT.100067443	Bix Connector to Alligator Clips 16" Cord	TC-P2BIX
	330 950 486	Castle to 526A and 463A 16' Cord	TC-6W3E
	ATT.100067449	Quick Disconnect 471A to 310 4' Cord	TC-SC371
	ATT.100067453	SLC 96 to Alligator Clips 16" Cord	TC-SLC96

Ph: 1-800-526-2673

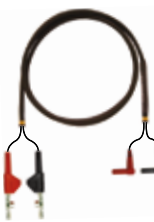

[www.westek.com](http://www.westek.com)

Fax: 1-800-526-3299

# AT&T Replacement Cords

	PID #	Description	Part #
	ATT.100420130	R/A Banana Grn to LHTCABP Grn	TC-3300BP-GN/5
	ATT.100420150	2 R/A Bananas Yel/Blu to 2 LHTCABP Yel/Blue	TC-3300BPYB
	ATT.100420140	2 R/A Bananas Red/Blk to 2 LHTCABP Red/Blk	TC-3300BPRB
	ATT.100420180	Shrouded Mini Banana to 2 Alligator Clips Red/Blk	TC-3008RX/6
	ATT.100420200	Mini Banana to Alligator Clip (Green)	TC-3004GN/6
	ATT.100420190	Shrouded Mini Banana to 2 Alligator Clips Yel/Blue	TC-3008TX/6

# Modular Cords

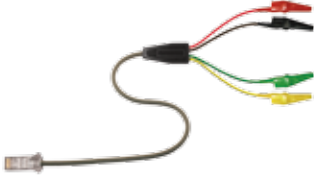
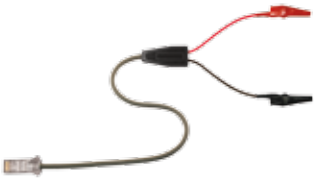
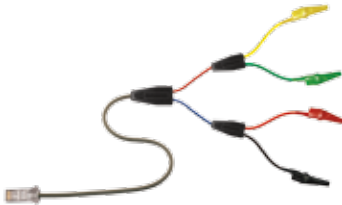
	<b>PID #</b>	<b>Description</b>	<b>Part #</b>
	ATT.100067318	RJ48 to RJ48 10' Royal Blue Cord	TC-140
	323 950 485	15 pin Male to RJ48 8' Cord	TC-15MRJ48
	ATT.100067462	RJ48 to Y Bantam wired 1245 6' Cord	TC-TR248C/6
	ATT.100067460	8' Cord	TC-TR248C
	ATT.100067461	10' Cord	TC-TR248C/10
	ATT.100067373	RJ48 to 4 Alligator Clips 8' Cord	TC-4PL1
	ATT.100067361	RJ48 to Alligator Clips 8' Cord	TC-2PL1
	ATT.100067406	RJ48 to Y 4 Alligators 16' Cord	TC-L1RJ48

Ph: 1-800-526-2673

Fax: 1-800-526-3299

[www.westek.com](http://www.westek.com)



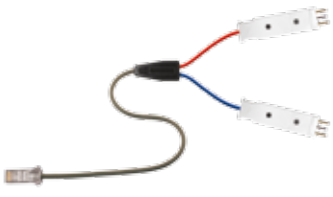
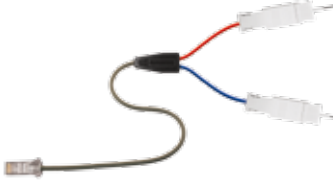

# Modular Cords

	PID #	Description	Part #
	ATT.100067393	RJ48 to Y 463A TX & RX 16' Cord	TC-L4RJ48
	ATT.100067432	RJ48 to Y Porta TX & RX 16' Cord	TC-L8RJ48

Can't Find The Cable  
You're Looking For?



# Data Cords

	<b>PID #</b>	<b>Description</b>	<b>Part #</b>
	ATT.100070079	9 pin M to 9 Pin F 6' Cord	TC-9M9F/6
	ATT.100080925	10' Cord	TC-9M9F/10
	ATT.100068100	15' Cord	TC-9M9F/15
	239 013 303	310 "Y" to 15 pin Female 2' Cord	TC-15F310/2
	ATT.100001955	25 pin Male to 9 pin Female 10' Cord	TC-25M9F/10
	ATT.100014781		TC-25M9F/15
	ATT.100014783		TC-25M9F/25
	ATT.100035812	9 pin Female to 9 pin Female Null Modem wiring 10'	TC-NM9F9F/10



## Contact Us!

Westek cable specialists are available Monday through Friday, from 7a.m. to 4p.m. Pacific Standard Time to assist you with higher quality cables, cost reduction, and engineering support!

Ph: 1-800-526-2673







[www.westek.com](http://www.westek.com)

Fax: 1-800-526-3299

# Looping Plugs, Terminators & Adapters

	PID #	Description	Part #
	ATT.100067445	P2EF Shorting Tool	TC-P2EFST
	ATT.100001777	RJ48 T1 Shorting Plug	TC-LPRJ48C
	ATT.100067496 ATT.100001775	RJ48 Ethernet Looping Plug	TC-LPRJ48E
	ATT.10000583	Dual Bantam Looping Plug	TC-LP250
	ATT.100067437	Dual Bantam Looping Plug 2 Conductor	TC-LP251
	ATT.10000589	Dual 310 Looping Plug	TC-LP350
	320 950 488	310 Terminating Plug 100 Ohms	TC-TP300

# Looping Plugs, Terminators & Adapters

	<b>PID #</b>	<b>Description</b>	<b>Part #</b>
	ATT.100000569	Bantam Terminating Plug 100 Ohms	TC-TP200
	ATT.100067454	135 Ohms	TC-TP201
	301 057 675	600 Ohms	TC-TP206
	ATT.100067459 or ATT.100063534	900 Ohms	TC-TP209
	ATT.100067459	310 Terminating Plug 135 Ohms	TC-TP301
	ATT.100000605	800 Duplex Yellow Looping Plug	TC-LP800
	ATT.100067383	Female 463A to Porta 1' Cord	TC-AD303
	ATT.100000585	310 to Bantam Adapter Blue	TC-AD310B
	ATT.100067384	310 to Bantam Adapter Red	TC-AD310R

Ph: 1-800-526-2673

[www.westek.com](http://www.westek.com)





Fax: 1-800-526-3299

# Looping Plugs, Terminators & Adapters





	PID #	Description	Part #
	ATT.100011777	440A to BNC Adapter	TC-AD440
	ATT.100011779	358A to BNC Adapter	TC-AD358
	ATT.100067506	BNC Coupler	TC-BNCCPLR
	ATT.100067986 ATT.100001927	9 pin Female to 9 pin Female Low Profile Gender Changer	TC-GCPC9F TC-GCPC9F
	206 013 252	9 pin Male to 9 pin Male Low Profile Gender Changer	TC-GC9M
	ATT.1000 1859	9 pin Male to 9 pin Female Low Profile Null Modem	TC-NM900LP





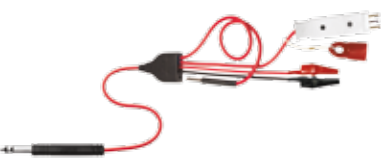

# Looping Plugs, Terminators & Adapters

	<b>PID #</b>	<b>Description</b>	<b>Part #</b>
	ATT.100001933	25 pin Female to 25 pin Female Low Profile Gender Changer	TC-GCPC25F
	203 013 255	25 pin Male to 25 pin Male Low Profile Gender Changer	TC-GCPC25M
	ATT.100001855	25 pin Male to 25 pin Female Low Profile Null Modem	TC-NM100LP
	561 991 175	25 pin Looping Plug Pinned: 3-15, 4-16, 6-18, 7-19, 9-21, 10-22, 12-24, 13-25	TC-LP25F



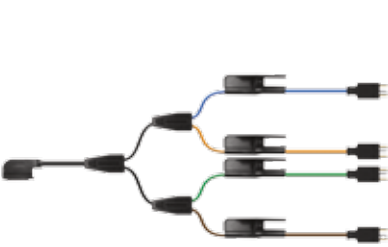

# Utility Patch and Test Cords

	PID #	Description	Part #
	ATT.100000673	Heavy Test Clip with Bed of Nails and Pin to Heavy Test Clip with Bed of Nails and Pin 6' Cord	TC-606
	ATT.100000597	Chuck End to Chuck End 8' Cord	TC-WC750
	ATT.100017276	310 to 463A w/ sheath, Alligator Clips and holstered Bantam 15' Blue Cord	TCC-323 TX
	ATT.100067423	310 to 463A w/ sheath, Alligator Clips and holstered Bantam 15' Red Cord	TCC-323 RX
	ATT.100000765	Alligator to Mini Chuck End 3' Cord	TC 16817/3
	ATT.100011875	ADSL Test Cord: "Y" RJ-11's (labeled In & Out) to "Y" 463A and Alligator Clips 10' Cord	TC 16316/10

# Utility Patch and Test Cords

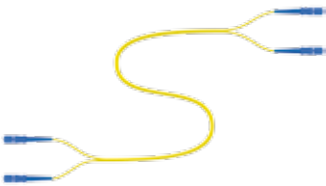
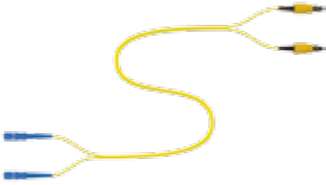
	PID #	Description	Part #
	798 993 135	ADSL Protector Displacement Cable Left Interface, 14'	TC-AT100BSL/14
	800 993 131	Left Interface, 22'	TC-AT100BSL/22
	797 993 136	Right Interface, 14'	TC-AT100BSR/14
	799 993 134	Right Interface, 22'	TC-AT100BSR/22
	562 991 174	ADSL Protector Displacement Cable Extension 5' Cord	TC-AT100EXT/5
	ATT.100013474	10' Cord	TC-AT100EXT/10
	562 991 172	15' Cord	TC-AT100EXT/15
	562 991 171	20' Cord	TC-AT100EXT/20
	562 991 170	25' Cord	TC-AT100EXT/25
	ATT.100067485	463A to 125BW 10' Cord	TC-W4DG/10
	ATT.100067484	16' Cord	TC-W4DG
	ATT.100000709 ATT.100031445 ATT.100067453	DSLC-5 to Cabinet Mount with lapel clip 2' Cord	TC-SL5C
	ATT.100000711	DSLC-5 to Cabinet Mount 2' Cord	TC-SL5M

# Miscellaneous

	PID #	Description	Part #
	467 002 143 468 002 142 470 002 148 471 002 147	SC to SC Single Mode Duplex  10' 12' 15' 20'	FC 33102/10 FC 33102/12 FC 33102/15 FC 33102/20
	473 102 143 475 002 143 476 002 142 477 002 141	SC to Biconic Single Mode Duplex  10' 12' 15' 20'	FC 35102/10 FC 35102/12 FC 35102/15 FC 35102/25
	ATT.100017064	Small Cord Bag Blue	CB 05190 000
	ATT.100068131	Large Kit Bag Black	TC-P01
	ATT.100067507	Lock Out Tag 1 3/4" x 7" 100 pack	CS 31001

# Miscellaneous

	PID #	Description	Part #
	ATT.100013623 ATT.100013613 ATT.100013625 ATT.100013615 ATT.100013627 ATT.100013617 ATT.100013629 ATT.100013619 ATT.100013631 ATT.100013621	Fingerless Frame Glove  X-Small Left X-Small Right Small Left Small Right Medium Left Medium Right Large Left Large Right X-Large Left X-Large Right	TC-GLOVE-XSL TC-GLOVE-XSR TC-GLOVE-SL TC-GLOVE-SR TC-GLOVE-ML TC-GLOVE-MR TC-GLOVE-LL TC-GLOVE-LR TC-GLOVE-XLL TC-GLOVE-XLR
	ATT.100011763	Replacement Battery for Tel-Line Tester Pro or Fiber Puller	MH 08388



Laptop Kit  
Part# KT 290152  
**PID# ATT.100067412**

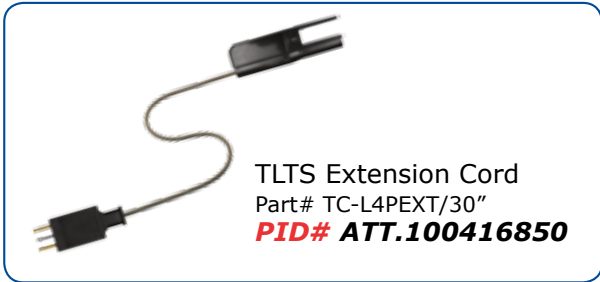

TLTS Extension Cord  
Part# TC-L4PEXT/30"  
**PID# ATT.100416850**

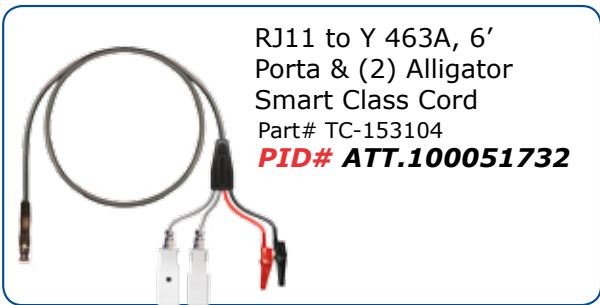

RJ11 to Y 463A, 6'  
Porta & (2) Alligator  
Smart Class Cord  
Part# TC-153104  
**PID# ATT.100051732**



Frame Gloves

<i>AT&amp;T PID#</i>	<i>Description</i>	<i>Part#</i>
ATT.100013623	X-Small Left	TC-GLOVE-XSL
ATT.100013613	X-Small Right	TC-GLOVE-XSR
ATT.100013625	Small Left	TC-GLOVE-SL
ATT.100013615	Small Right	TC-GLOVE-SR
ATT.100013627	Medium Left	TC-GLOVE-ML
ATT.100013617	Medium Right	TC-GLOVE-MR
ATT.100013629	Large Left	TC-GLOVE-LL
ATT.100013619	Large Right	TC-GLOVE-LR
ATT.100013631	X-Large Left	TC-GLOVE-XLL
ATT.100013621	X-Large Right	TC-GLOVE-XLR



110D to Round Lugs  
Part# TC-P2E6A

**PID# ATT.100067444**

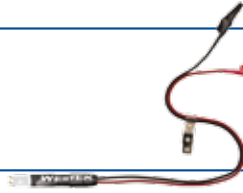

353A to Alligator Clips  
Part# TC-P2EF

**PID# ATT.100001409**

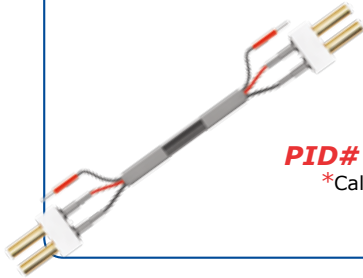

Dual 440D to Dual  
440D with Tracer  
Part# TC-D452T

**PID# ATT.100007063**

\*Call for PID# on various  
lengths offered



RJ48 to Y Bantam  
wired 1245  
Part# TC-TR248C

**PID# ATT.100067460**

Part# TC-TR248C/6

**PID# ATT.100067462**

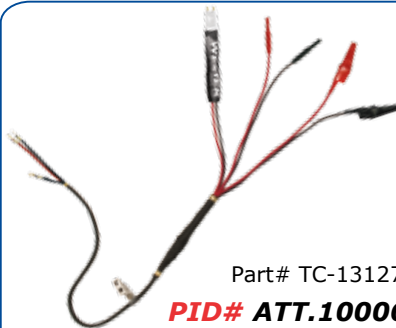

Part# TC-13127

**PID# ATT.100067309**

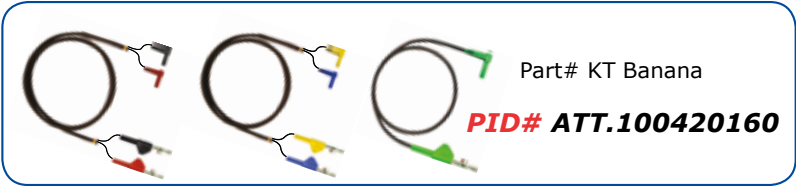



OSP Combi-Cord

Part# TC-OSPACGN

**PID# ATT.100034634**

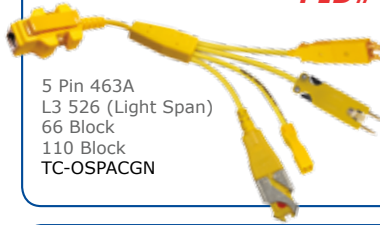

5 Pin 463A  
L3 526 (Light Span)  
66 Block  
110 Block  
TC-OSPACGN

OSP Combi-Cord

Part# TC-OSPEFHQ

**PID# ATT.100002796**

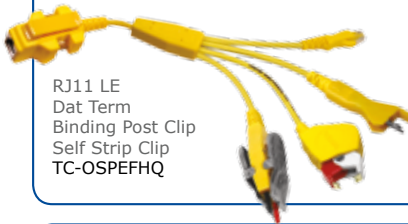

RJ11 LE  
Dat Term  
Binding Post Clip  
Self Strip Clip  
TC-OSPEFHQ

RJ11 to Heavy Test  
Clips, with Bed of  
Nails and Pin

Part# TC-611LTBP/5

**PID# ATT.100067381**

Part# TC-611LTBP/8

**PID# ATT.100067380**

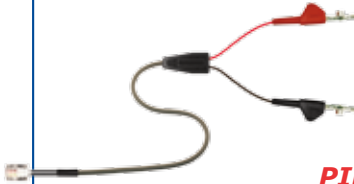

Buttset  
Replacement  
Cord

Part# TC-162202

**PID# ATT.100011861**

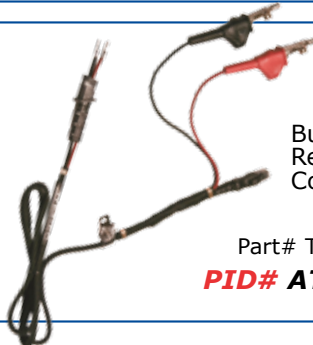



# THE FASTEST ROUTE FROM DESIGN TO PRODUCTION

*Westek's engineering team can put a working model in your hands!*

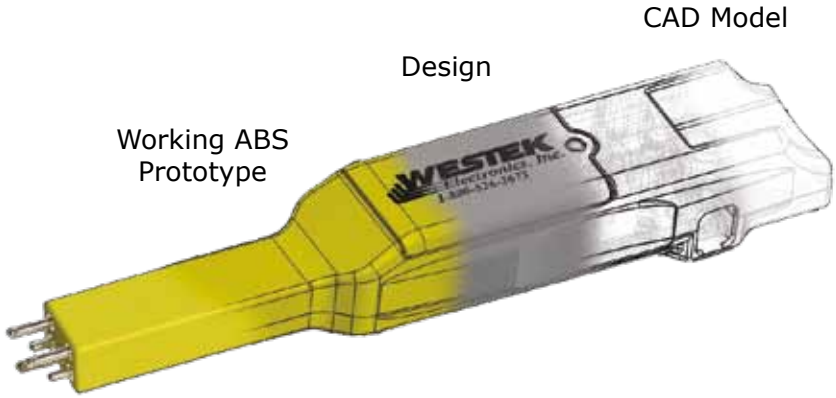

Nothing communicates design ideas faster than a three-dimensional part or model.

Westek can bring your CAD files and design ideas to life. Test form, fit and function using as many design iterations as you need with functional ABS parts to beat your competitors to the marketplace.

Unlike appearances prototypes produced in weak materials, our 3D printer will generate durable, working models in ABS (acrylonitrile butadiene styrene) plastic. ABS 3D models can withstand rigorous functional testing. ABS is the material of choice by leading manufacturers and is a major reason why our prototypes resemble a finished product.



Ph: 1-800-526-2673

[www.westek.com](http://www.westek.com)

Fax: 1-800-526-3299

sales@westek.com  
185 Westridge Drive  
Watsonville CA 95076  
PH 800.526.2673  
FAX 800.526.3299

## QUALITY

- Westek's ISO, TL & UL Quality Assurance include risk management, experimental design, verification, validation, statistical techniques, gauge repeatability, reproducibility, and process capabilities.
- Westek's quality system is a continuous process from incoming material inspection, documentation of every manufacturing process, component identification for complete traceability, and 100% final inspection of all orders, regardless of size.
- Westek's product failure rate is less than 0.1 percent!
- Westek's certifications:
  - ISO 9001:2008 Certified
  - TL 9000
  - UL Listed & Approved
  - BICSI member
  - IPC-620A
  - ISO 13485

