

**30 years of  
Excellence in Connectivity!**



**Verizon SSI Guide**



## WESTEK ELECTRONICS EXPANDED TO NEW LOCATION

Westek has moved! This dynamic operational change is designed to assure continued commitment to optimum customer service and custom cable manufacturing excellence. From our new building headquartered in Watsonville, California, we will provide you with the highest level of service no matter how large the scope of your project may be.

Westek is the 4th company over all in the USA to be standardized to the upgraded ISO 5.0 Manufacturing Standard. "We could not be more proud of our team achieving this level of ISO certification. Our growth and continual improvement is a reflection of the well trained and dedicated staff." States, Michael Hushaw, Vice President Operations.

Westek Electronics, Inc. was the First Telecommunication Cable Manufacturer in the world to be certified to the LRQA (Lloyd's Register Quality Assurance) Re-Certification audit and "upgrade" to the ISO 9001:2008 standard back in August 2009.

Westek Electronics, Inc. is located in Santa Cruz County, at 185 Westridge Dr., Watsonville, CA 95076. For more information on Westek Electronics, Inc. products and services go to: [www.westek.com](http://www.westek.com) or call 800-526-CORD.

About Westek: Westek Electronics, Inc. has been a leader in Telecommunications for over 30 years. Westek Electronics, Inc. also specializes in the Test & Measurement, Medical and Military/GSA industries. Westek Electronics Inc., holds dual certification, as now audited by DEKRA, in regard to ISO 9001:2008 and TL9000-H since 2014. Westek Electronics, Inc. was the 6th company in the United States to be certified to revision 4.0 in TL 9000.



800.526.2673 | www.westek.com

KT-291052

# Tel-Line Tester Pro™

Allows you to troubleshoot cable pairs in seconds

**PATENTED**

Light your way to a solution



**-Three Step Testing-**



## STEP 1: REMOVE PROTECTOR

Access using 5 Pin Protector at building entrance, CEV, SLC remote and Central Office with protection. Removes the need to physically cut into the line to isolate the pair.

## STEP 2: TEST PROTECTOR

Insert protector into Tel-Line Tester Pro. Press "Test" Button. Test light LED glows **Green** if protector is good, and **Red** if the protector is bad.

A white LED flashlight is located at the tip for locating target.

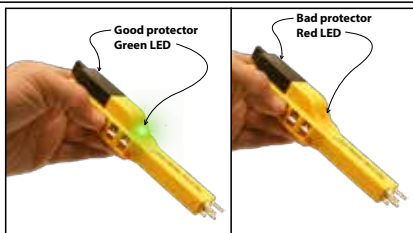

## STEP 3: TROUBLESHOOT

Clip a buttset or voltmeter to the metal tabs marked "Tip" and "Ring in" and look to the switch. Move the clips to the tabs marked "Tip" and "Ring out" and look to the field. To restore temporary service to the customer while troubleshooting, simply plug in the OSP kit's modular looping tool.

## Tel-Line Tester Pro Kit

SSI # 11056256

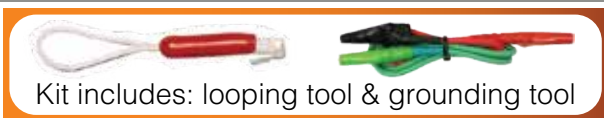

Kit includes: looping tool & grounding tool

Ph: 1-800-526-2673

www.westek.com

Fax: 1-800-526-3299



Providing Excellence in Connectivity  
for 30 years strong.

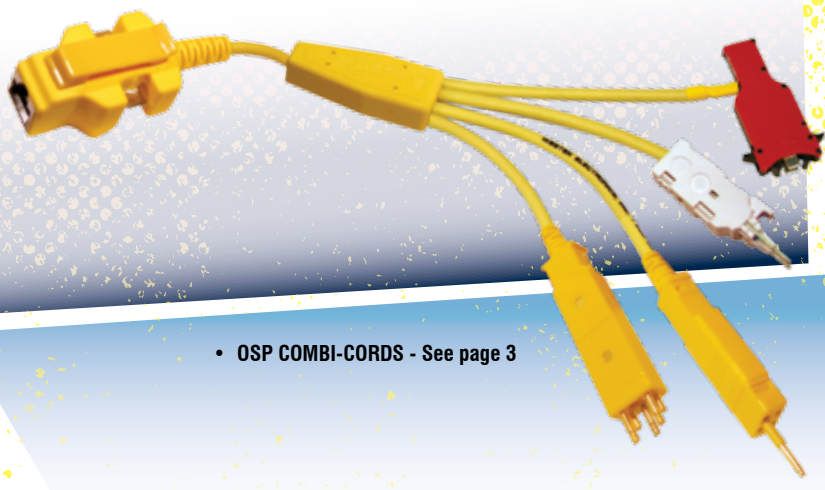

• OSP COMBI-CORDS - See page 3



## Table of Contents

Combi-Cords.....	4-11
BantamCords.....	15-17
310 Cords.....	17-19
Data Communication Cords.....	19
Coax Assemblies.....	20-25
AT&T Replacement Cords.....	25-28
OSP Combi-Cords.....	29-31
Modular Cords.....	33-35
463A Cords.....	36-37
Adapters.....	37-39
Testers.....	41-43
Miscellaneous.....	44
Cord Kits.....	45-53

## Universal Portable Worklight



### Magnetically Attach:

Splice Case Support Rack Brackets  
Side of Vehicle or any metal surface

### Mechanically Clamp:

Aerial Support Cables and wires  
1' Safety Lanyard Provided



### Features:

- 1500 lumen
- Hi/Lo Beams
- Withstands 100mph winds
- Charge 110/12v
- Battery life 15-16hrs (low) 7-8hrs (high)
- Continuous lighting power on 110v
- Charging time 5-7hrs
- Water resistant IP65 certified
- Heavy Duty Construction

SSI# 11329563

PN:TC-LEDFLDSMALL



D-Cable Lashing Clamp (1) for  
Aerial Mount for Pole Work



## Fiber Puller Insertion and Removal Tool

**FP 360023 VERIZON SSI#11344911**

Westek's Fiber Tool installs and removes: SC, FC, ST, LC, and COAX/DS3 connectors. This elegant device simply fits into a shirt pocket or tool pouch and is ergonomically designed to fit the hands of today's technician while at the same time mitigates any potential for repetitive motion or significant squeeze issues/injuries. This is the only tool on the market that can solve connectorization issues for Telephone and Cable Facility Providers as well as Enterprise Data Centers. It supports all Fiber optic modes, both SingleMode and MultiMode, including WDM, DWDM and CDWM and their derivatives in FTTx (Premises/Node/Home). This product exceeds the stringent requirements dictated by Telcordia Technologies, ANSI, OSHA, FDA, NTA and the IEC.

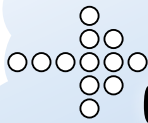

# One Tech, One Ticket.

## Reduce Repeat Repairs

The OSP product line reduces truck rolls, saves time and promotes productivity by having all of the necessary tools needed on the job.

Test right the first time! With the OSP time saving tools from Westek, one technician can tackle one ticket.



T1 Kit OSP  
SSI# KT 290104



Tel-Line Tester Pro  
SSI# 11056256

Laptop Kit  
SSI# KT 290149



Combi-Cord  
TC-OSPDKMN  
SSI#11090300





# OSP Combi-Cords

## WESTEK CABLE AND TEST SOLUTIONS

### OVERVIEW

Westek's OSP Combi-Cord is a multiended test cord that allows technicians to access various types of terminal and connector blocks with one cable. OSP Combi-Cords provide technicians with all the necessary plug-ins on a one foot cable.

### FEATURES AND BENEFITS

- More productive circuit testing by having four different test plugs on one test cord.
- Easy testing of POTS, ADSL and VDSL.
- Works with all major test sets and tone generators.
- Test clips for easy butt set access.
- 7" Lanyard for weight relief.
- Reduced truck rolls by having four different test plugs on a single cord.
- No more loosing of multiple test accesscords.
- Cost savings by replacing four test cords with one multi connector test cord.
- Manufactured to the highest industry standards.
- Belt clip for easy transportation.
- Protective dust covers for RJ11, 5 pin L4 (463A) and L3 (526) connectors.
- RJ-11 looping plug available.
- Molded in bright yellow to prevent misplacement.
- Designed to fit most tool pouches.
- 2 year warranty.

### SPECIFICATIONS

Cable	2 Conductor, 24AWG, twisted pair, shielded
Voltage	500V (Dielectric Strength)
Insulation	Jacket: Polyvinyl Chloride -PVC, Conductors: Polypropylene
Operating Temperature	-4° F to 176° F (-20° C to + 80° C)
Humidity	90% (non-condensing) max.
Length	12 inches (31 cm)
Weight	5 oz (150 g)
RJ11 Looping Tool	PN: TC-LE11LOOP

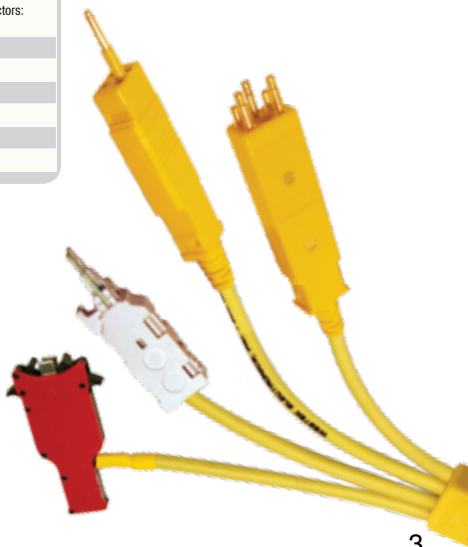

# Combi-Cord Sample Order

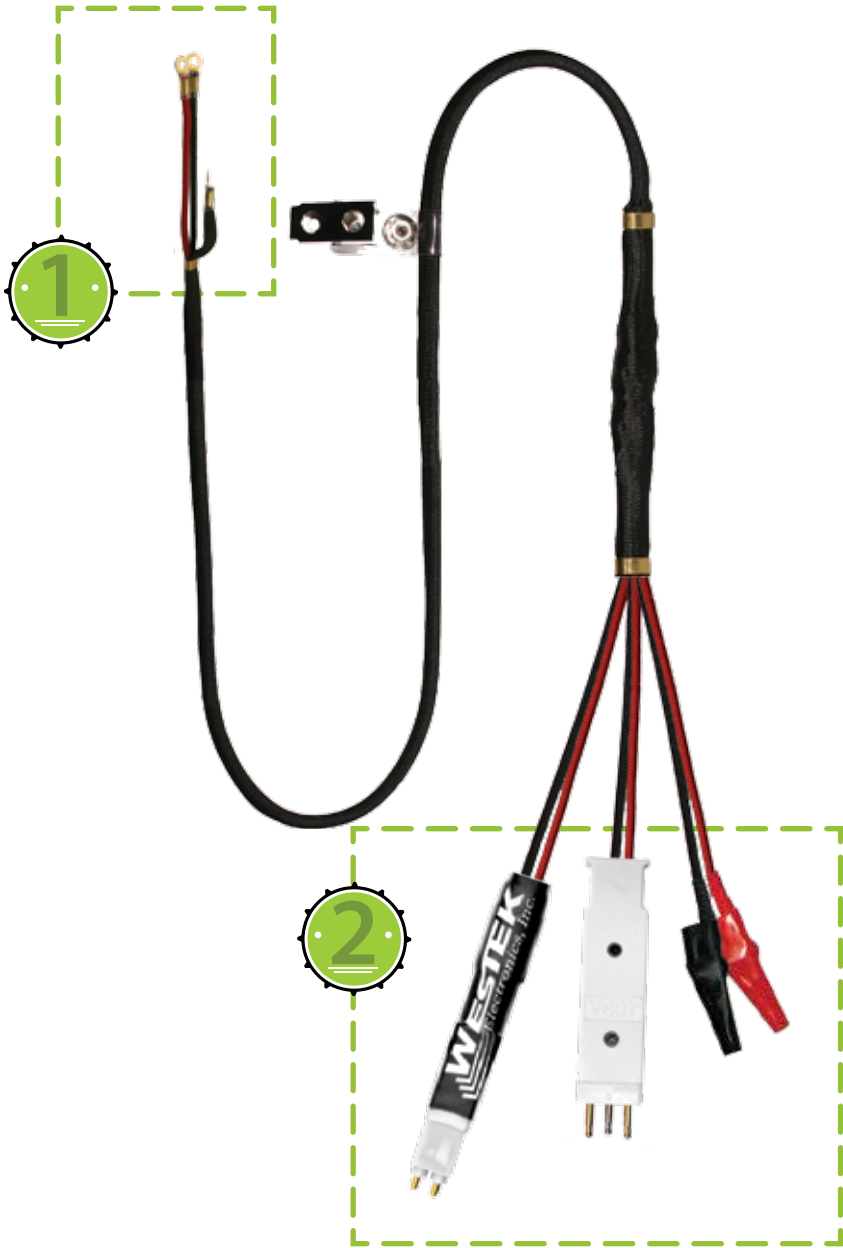



## Steps to ordering Combi-Cords:

1

Choose Buttset End Connection

2

Choose Components  
(Up to 5 Total)

## *Combi-Cord Benefits*

- Ultra-durable nylon braided jacket guarantees ruggedness and flexibility.
- Junction is constructed using insulated piercing lugs secured by a lock nut with a solder weld.
- Highest quality components made of state of the art materials insure long life and dependability.
- Red/Black nylon braided jacket protects insulated tinsel conductor.
- Combi Clip keeps plugs that are not in use and out of the way.

# Combi-Cord Ends



## Choose Buttset End Connection

**B1**....Hardware (w/Strain Relief)



**B3**....Hardwire (Round Lugs)



**B4**....Modular Type, 4 Conductor, RJ22



**B6**....Modular Type, 6 Conductor, RJ11



**B8**....Modular Type, 8 Conductor, RJ45 / RJ48



**TS22**...For Fluke/Harris test sets



**TS44/TS52**.... For Fluke/Harris test sets



**B2**.... Quick Disconnect Option (471A QD or WECO Type 471A QD)



# Combi-Cord Ends



## Choose Components (Up to 5 Total)

**LMOD4**....Modular type plug, 4 conductor, RJ22



**LMOD6**....Modular Type Plug, 8 conductor, RJ11



**LMOD8**....Modular Type, 8 Conductor, RJ45 / RJ48



**LO**....Miniature alligator clips (Mueller #30) ; (one pair: red /black)



**LS**....Step switch space lug



**LX**....Porta (Plugs into test field)



**LBIX**....Bix connector (QTBIX17-NT)



**LMG**....Mini Grabbers (one pair: red /black)



**LNAN**....Banana Plug



**LOE**....Northern Telecom Original Equipment



**LSLC5**....SLC-5 Plug



Ph: 1-800-526-2673

[www.westek.com](http://www.westek.com)

Fax: 1-800-526-3299

# Choose Components continued...

**310...**310 Plug



**L3M...**3M Binding Post Clip



**L4....**463A (Replaces 5 Pin Protector)



**L4W0....**L4 (without ground pin, looks in and out)



**L5....**P2FM Equivalent (AT&T 310 and 311)



**L6....**Large Chuck ends (adapter 360 Tool) ; (one pair: red /black)



**L7....** Chuck Ends (over wire wrap pins) ; (one pair: red /black)



**L8....**Porta (replaces protector)



**L9....**Porta (plugs into protector)



**L96....**SLC-96 Plug (equivalent to mini-plug)



**LDBAN....**Dual Bantam Plug



# Combi-Cord Ends

**L1**....Alligator Clips (Mueller #60)



**L110**....AT&T 110 Connector Plug



**L110D**....110 D Test Connector



**L2**....453A or P2EF equivalent (AT&T 303 & 309-NT 377)



**L284**....Amphenol 284-1 Plug for 66 Block



**L299**...Plugs into NT 399 Block



**L3**....526A (Plugs into 4C Type Protector)



**LHTCAB**...Heavy Test Clips, Angle Nose, Bed of nails ; (one pair: red /black)



**LHTCAP**....Heavy Test Clip, Angle Nose, Single Pin ; (one pair: red /black)





Ph: 1-800-526-2673

[www.westek.com](http://www.westek.com)

Fax: 1-800-526-3299

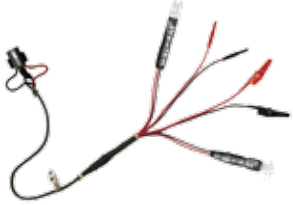
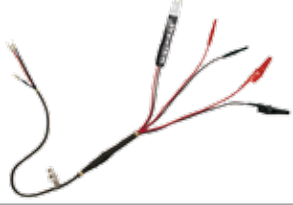
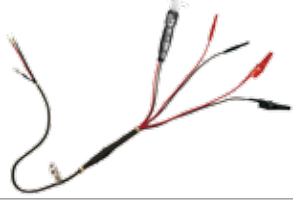
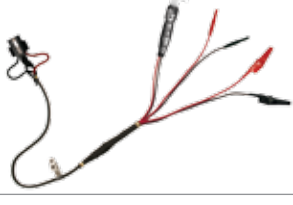
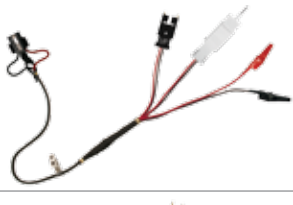
# Combi Cords

	SSI/PID #	Description	Part #
	700 222 467	B2, C4, L1, L2, L5, L7	TC 241257
	700 222 468	B1, C3, L1, L2, L7	TC 13127
	700 223 009	B1, C3, L1, L5, L7	TC 13157
	700 223 010	B2, C3, L1, L5, L7	TC 23157
	999 598 741	B2, C3, L1, L8, L9	TC 23189
	999 606 049	B2, C3, L1, L2, L3	TC 23123

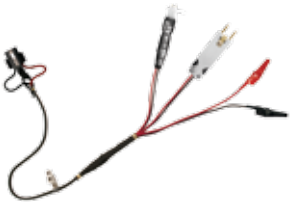
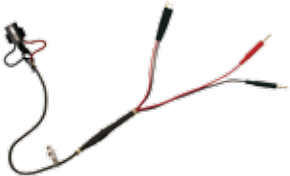
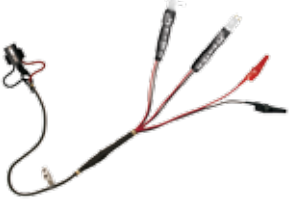
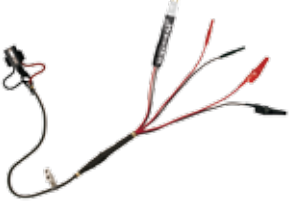
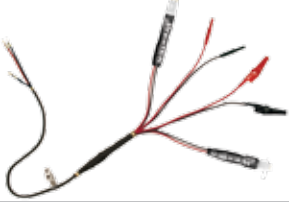
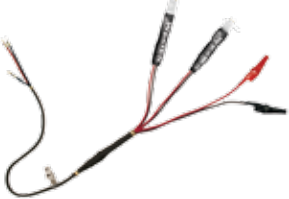

# Combi Cords

	SSI/PID #	Description	Part #
	110 192 44	B2, C3, L1, L3, L5	TC 23135
	112 029 32	B2, C2, LSLC5, LSLC96 pins	TC 22YZt
	700 222 463	B2, C3, L1, L2, L5	TC 23125
	700 222 464	B2, C3, L1, L2, L7	TC 23127
	700 222 465	B1, C4, L1, L2, L5, L7	TC 141257
	700 222 466	B1, C3, L1, L2, L5	TC 13125

# Tel-Line Assistant

## WESTEK CABLE AND TEST SOLUTIONS

### OVERVIEW

Westek Tel-Line Assistant (TLA) is a remotely controlled Far End Device that uses DTMF signaling to set up loop test conditions for use in Resistive Fault Locate (RFL) testing. OSP technicians can use the TLA as the perfect companion to their RFL test equipment to test local subscriber loops single handedly with fewer truck rolls.

### FEATURES AND BENEFITS

- Allows a technician to perform section analysis without using a second technician.
- Relay functions: Open Circuit, Tip to Ground, Ring to Ground, Tip to Ring, Tip & Ring to Ground.
- Compatible with most RFL test equipment.
- 22,000 feet operating range.
- Field programmable test durations.
- Supports copper loop qualification for DSL/VDSL
- Supports Open, Leakage, Balance, and Noise Mitigation tests.
- Tracer tone can be detected for up to 4,500 feet and controlled remotely.
- Standby mode allows services to continue until the test mode is accessed.
- Can be left in-place without compromising the POTS circuit.
- Small enough to be locked in a cabinet or splice enclosure.
- Light, compact, and easy-to-carry. Battery included.

### SPECIFICATIONS

Operating Range	22,000 feet
Tracer Tone Range	4,500 feet (Detectable with cable tracing probe)
Bandwidth	20KHz to 2.2 MHz
DC Rating	48 VDC
Tracer Tone	839 Hz and 1008 Hz alternating at 5 Hz rate
Ready Tone	578 Hz
Environmental	
Operating Temperature	-18° C to +60° C (0° F to 140° F)
Storage Temperature	-40° C to +75° C (-40° F to 165° F)
Humidity	90% (non-condensing) max
Mechanical	TC-311
Size	19.1 cm x 3.6 cm x 3.0 cm (7.5" x 1.4" x 1.2")
Weight	118g (4.0 oz)
Battery life	≥ 40 hours typical
Battery Shelf life	1 month (installed)
Replacement battery recommended:	Duracell TM MN 1604 Alkaline of rechargeable 9V
Part Number TLA	TC-TLA FED

KT TLAFED

SSI# 11182263



	SSI #	Description	Part #
 <p><b>SSI# 11182263</b></p>	11182263	<p><i>TLA FED Device kit includes quick reference guide, operational guide, &amp; two cords:</i></p> <p>TC 162241: L4(F)Cradle to Short 463A(L4)</p> <p>TC-TLA3087: L4(F) Cradle Y (5) LHTCAB 30"</p>	KT-TLA FED



A single technician can pre-qualify a copper pair for POTS, Data, and DSL.

**“One Tech, One Ticket.”**

- **Remote Test and Tone Access**
- **Reduce Truck Rolls**

Ph: 1-800-526-2673

Fax: 1-800-526-3299

[www.westek.com](http://www.westek.com)



Test right the first time with Westek's patented tools that will expedite job tickets.



NIU Kit



Banjo Pro

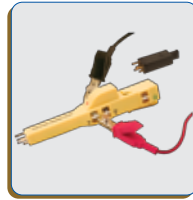

Tel-Line Tester Pro

- The OSP Combi-Cords are available in multiple variations:

Standard cords feature the recommended plug ends for 90% of field applications and the custom "built-to-suit" cord versions fit any field technicians special needs.

- One cord access at a fraction of the cost of four individual test cords

### Combi-Cords

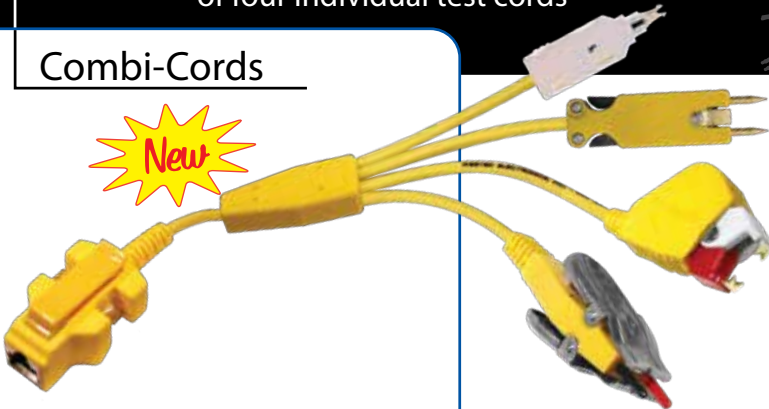

Quick easy access to laptop and test equipment  
Weather resistant to withstand outside elements







Connectors:

Krone, L3 (526), Binding Post Clips, Self Strip Clip



Your World. Connected.

# Bantam Cords







	SSI/PID #	Description	Part #
	001 238 229	Dual Bantam to 463A 15' TX	TC-5P250TX/15
	700 248 005	Dual Bantam to 463A 15' RX	TC-5P250RX/15
	001 237 072	Bantam to 463A 8' Blue Cord	TC-5P200TX/15
	001 237 080	Bantam to 463A 8' Red Cord	TC-5P200RX/15
	001 492 354	Female Bantam to BIX Connector 1' Blue Cord	TC-297 TX/1
	001 492 362	Female Bantam to BIX Connector 1' Red Cord	TC-297 RX/1
	001 238 286	Female Bantam to 110 Connector 1' Blue Cord	TC-210F TX/1
	001 238 294	Female Bantam to 110 Connector 1' Red Cord	TC-210F RX/1
	102 653 508	Dual Bantam (2 Conductor) to 463A 16' Cord	TC-W4CT
	700 242 963	Bantam to Bantam 8' Gray Cord	TC-200
	001 237 130	Bantam to Bantam 8' Black Cord	TC-200BLK
	001 236 785	Bantam to Bantam 8' Blue Cord	TC-200TX
	001 237 049	Bantam to Bantam 8' Red Cord	TC-200RX

Ph: 1-800-526-2673





Fax: 1-800-526-3299

www.westek.com

# Bantam Cords

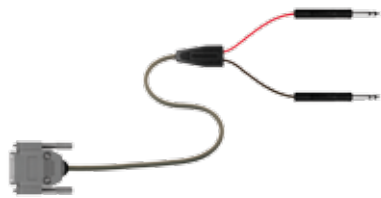
	SSI/PID #	Description	Part #
	001 492 321	Female Bantam to Krone Connector 1' Blue Cord	TC-925F TX/1
	001 238 179	Female Bantam to Krone Connector 1' Red Cord	TC-925F RX/1
	001 238 187	Female Bantam to 66 Block Connector 1' Blue Cord	TC-266F TX/1
	001 492 339	Female Bantam to 66 Block Connector 1' Red Cord	TC-266F RX/1
	700 242 965	Dual Bantam to RJ48 8'	TC-259
	001 237 155	Bantam to Wire Wraps 8' Blue Cord	TC-272TX
	001 237 171	Bantam to Wire Wraps 8' Red Cord	TC-272RX
	001 238 088	Bantam to Alligator Clips 8' Blue Cord	TC-260TX
	011 492 313	Bantam to Alligator Clips 8' Red Cord	TC-260RX
	001 238 203	Bantam "Y" to RJ48C 8' Wired 1,2,4,5	TC-TR248C
	001 464 692	Bantam "Y" to RJ48S 8' Wired 1,2,7,8	TC-TR248S

# Bantam Cords

	SSI/PID #	Description	Part #
	001 238 211	Bantam "Y" to 15 pin Female 8'	TC-15F200
	001 238 146	Bantam to Heavy Test Clip, Bed of Nails 8' Blue Cord	TC-260LTB TX
	001 238 153	Bantam to Heavy Test Clip, Bed of Nails 8' Red Cord	TC-260LTB RX
	001 237 056	Bantam to 310 8' Blue Cord	TC-230TX
	001 237 064	Bantam to 310 8' Red Cord	TC-230RX
	102 564 002	Dual Bantam (2 Conductor) to 463A 16' Cord	TC-W4CP

# 310 Cords



	SSI/PID #	Description	Part #
	101 426 492	310 to 310 1' Cord	TC-310/1
	102 315 017	310 to 310 3' Cord	TC-310/3
	700 226 957	310 to 310 6' Cord	TC-310/6

Ph: 1-800-526-2673

Fax: 1-800-526-3299

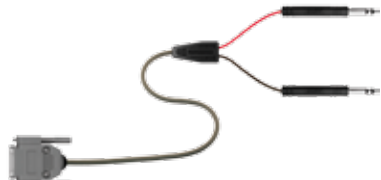
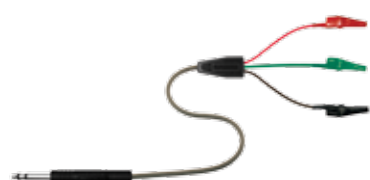

[www.westek.com](http://www.westek.com)

# 310 Cords

	<b>SSI/PID #</b>	<b>Description</b>	<b>Part #</b>
	700 242 959	310 to 310 8' Cord	TC-310
	700 242 960	310 to 310 10' Cord	TC-310/10
	102 314 739	310 to 310 12' Cord	TC-310/12
	112 87 501	310 to 310 20' Cord	TC-310/20
	112 87 500	310 to 310 50' Cord	TC-310/50
	700 228 128	310 to 66 Block Connector 8' Cord	TC-366
	700 242 961	310 to Bantam 8' Cord	TC-230
	700 228 129	310 to Bantam 10' Cord	TC-230/10
	700 242 966	310 "Y" to 15 pin Male 8' Cord	TC-15M310
	101 428 662	310 to (3) Alligator Clips 12' Cord	TC-3W3A/12



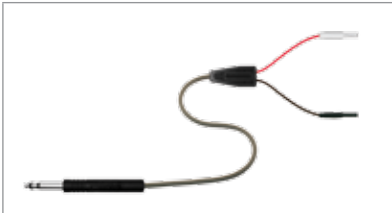

# 310 Cords

	<b>SSI/PID #</b>	<b>Description</b>	<b>Part #</b>
	101 428 290	310 to 360 Tools 6' Cord	TC-2W17A
	700 242 976	310 to 358A 10' Cord	TC-358/10

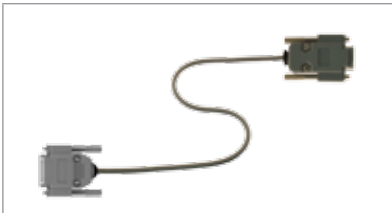
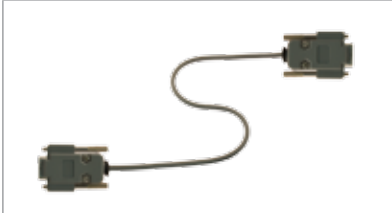

# Data Cords

	<b>SSI/PID #</b>	<b>Description</b>	<b>Part #</b>
	001 412 394	25 pin Male to 9 pin Female 10' Cord	TC-25M9F/10
	001 412 402	9 pin Male to 9 pin Female 10' Cord	TC-9M9F/10



# Coax Cords

	SSI/PID #	Description	Part #
		Dual BNC to Dual BNC with Tracer	
	700 249 307	2'	TC-D500T/2
	700 249 308	4'	TC-D500T/4
	700 249 309	6'	TC-D500T/6
	700 249 310	8'	TC-D500T
	700 249 311	10'	TC-D500T/10
	700 249 312	12'	TC-D500T/12
	700 249 313	14'	TC-D500T/14
	700 249 314	16'	TC-D500T/16
	700 249 315	18'	TC-D500T/18
	700 249 316	20'	TC-D500T/20
	700 249 317	22'	TC-D500T/22
	700 249 318	26'	TC-D500T/26
700 249 319	30'	TC-D500T/30	
		Dual 440D to Dual 440D with Tracer	
	700 249 320	6'	TC-D452T/6
	700 249 321	8'	TC-D452T
	700 249 323	10'	TC-D452T/10
	700 249 322	12'	TC-D452T/12
	700 249 324	14'	TC-D452T/14
	700 249 325	16'	TC-D452T/16
	700 249 326	18'	TC-D452T/18
	700 249 327	20'	TC-D452T/20
	700 249 328	22'	TC-D452T/22
	700 249 329	24'	TC-D452T/24
	700 249 330	26'	TC-D452T/26
	700 249 331	28'	TC-D452T/28
	700 249 333	30'	TC-D452T/30
	700 249 334	32'	TC-D452T/32
	700 249 335	34'	TC-D452T/34
	700 249 336	36'	TC-D452T/36
		BNC to BNC with Tracer	
	700 249 337	8'	TC-500T
	700 249 338	10'	TC-500T/10
	700 249 339	12'	TC-500T/12
	700 249 340	20'	TC-500T/20
	700 249 341	30'	TC-500T/30
	700 249 342	40'	TC-500T/40



# Coax Cords

	SSI/PID #	Description	Part #
		Dual 440D to Dual LCC with Tracer	
	700 251 397	8'	TC-D652T/8
	700 251 398	10'	TC-D652T/10
	700 251 399	15'	TC-D652T/15
	700 251 400	20'	TC-D652T/20
	700 251 401	25'	TC-D652T/25
	700 251 402	30'	TC-D652T/30
	700 251 403	35'	TC-D652T/35
	700 251 404	40'	TC-D652T/40
	700 251 405	45'	TC-D652T/45
700 251 406	50'	TC-D652T/50	
		Dual BNC to Dual LCC with Tracer	
	700 251 388	8'	TC-D531T/8
	700 251 389	10'	TC-D531T/10
	700 251 390	12'	TC-D531T/12
	700 251 391	14'	TC-D531T/14
	700 251 392	16'	TC-D531T/16
	700 251 393	18'	TC-D531T/18
	700 251 394	20'	TC-D531T/20
	700 251 395	22'	TC-D531T/22
	700 251 396	24'	TC-D531T/24
		Dual LCC to Dual LCC with Tracer	
	700 251 380	10'	TC-DLCCT/10
	700 251 381	12'	TC-DLCCT/12
	700 251 382	14'	TC-DLCCT/14
	700 251 383	16'	TC-DLCCT/16
	700 251 384	18'	TC-DLCCT/18
	700 251 385	20'	TC-DLCCT/20
	700 251 386	22'	TC-DLCCT/22
	700 251 387	24'	TC-DLCCT/24







# Coax Cords

	SSI/PID #	Description	Part #
 <p>2 cord set</p>		BNC to BNC and BNC to BNC with Tracer	
	110 209 22	5'	TC-TCK500T/5
	110 209 23	6'	TC-TCK500T/6
	110 209 24	7'	TC-TCK500T/7
	110 209 25	8'	TC-TCK500T/8
	110 209 26	9'	TC-TCK500T/9
	110 209 27	10'	TC-TCK500T/10
	110 209 28	11'	TC-TCK500T/11
	110 209 29	12'	TC-TCK500T/12
	110 209 30	13'	TC-TCK500T/13
	110 209 31	14'	TC-TCK500T/14
		LCC to LCC	
	700 251 371	8'	TC-LCC/8
	700 251 372	10'	TC-LCC/10
	700 251 373	12'	TC-LCC/12
	700 251 374	16'	TC-LCC/16
	700 251 375	18'	TC-LCC/18
	700 251 376	20'	TC-LCC/20
	700 251 377	26'	TC-LCC/26
700 251 378	30'	TC-LCC/30	
	001 412 352	BNC to BNC 8' Red Cord	TC-500RX
	001 412 345	BNC to BNC 8' Blue Cord	TC-500TX



# Coax Cords

	SSI/PID #	Description	Part #
	700 242 972	358A to 358A 10' Cord	TC-358A/10
	700 242 973	358A to 440A 10' Cord	TC-458A/10
	700 242 974	440A to 440A with Tracers 10' Cord	TC-440T/10
	700 242 975	440A to BNC 10' Cord	TC-540/10
	998 917 868	BNC to BNC 6' Cord	TC-500/6
	700 249 343	440A to 440A 1' Cord	TC-440A/1
	700 249 343	440A to 440A 10' Cord	TC-440A/10



# Coax Cords

	<b>SSI/PID #</b>	<b>Description</b>	<b>Part #</b>
	700 251 183	Female BNC to LCC 4 inch Cord	TC 16445/4"
	700 251 182	Female BNC to LCP 4 inch Cord	TC 16298/4"
	700 251 360 700 251 361 700 251 362 700 251 363	LCP to 440A 6' 8' 10' 12'	TC-445/6 TC-445/8 TC-445/10 TC-445/12
	700 251 364 700 251 365 700 251 366 700 251 367 700 251 368 700 251 369	LCP to LCP 10' 12' 16' 18' 20' 30'	TC-LCP/10 TC-LCP/12 TC-LCP/16 TC-LCP/18 TC-LCP/20 TC-LCP/30
	110 196 63	Mini SMB to BNC 5' Cord	D3 260056/5
	110 199 64	Mini SMB to Mini SMB 2' Cord	D3 260053/2





# Coax Cords

	SSI/PID #	Description	Part #
	700 251 370	LCP to BNC 8' Cord	TC-532/8
	700 251 379	LCC to BNC 8' Cord	TC-531/8

# AT&T Replacement Cords





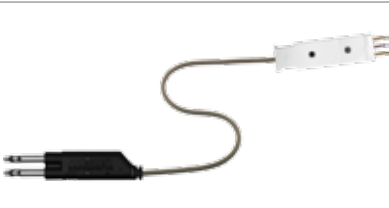

	SSI/PID #	Description	Part #
	001 412 295	RJ45 to RJ45 Cat5 10' Royal Blue Cord	TC-140
	101 428 290	310 to 360 Tools 6' Cord	TC-2W17A
	101 428 662	310 to (3) Alligator Clips 12' Cord	TC-3W3A/12

# AT&T Replacement Cords

	SSI/PID #	Description	Part #
	102 564 002	Dual Bantam (2 Conductor) to 463A 16' Cord	TC-W4CP
	101 426 492	310 to 310 1' Cord	TC-310/1
	102 315 017	310 to 310 3' Cord	TC-310/3
	700 226 957	310 to 310 6' Cord	TC-310/6
	700 242 959	310 to 310 8' Cord	TC-310
	700 242 960	310 to 310 10' Cord	TC-310/10
	102 314 739	310 to 310 12' Cord	TC-310/12
	101 898 633	463A to 327 Plug 16' Cord	TC-W4CJ
	102 500 402	Mini Alligator Clip to Mini Alligator Clip 13" Brown Cord	TC-W1AP
	102 564 002	463A to Dual Bantam 16' Black Cord	TC-W4CP

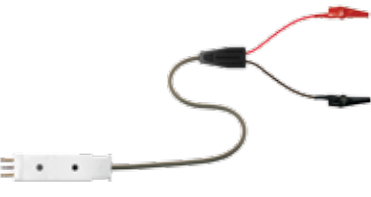

# AT&T Replacement Cords

	SSI/PID #	Description	Part #
	102 808 581	453A to Alligator Clips 16" Red/Black Cord	TC-P2EF
	103 105 276	526A to Alligator Clips 16" Red/Black Cord	TC-P2FL
	103 643 979	L5 to Alligator Clips 16" Red/Black Cord	TC-P2FM
	700 223 533	463A to 125BW 16' Cord	TC-W4DG
	001 238 104	Alligator Clip to Minigrabber 3" Blue Cord	TC-0065 TX/3"
	001 238 112	Alligator Clip to Minigrabber 3" Red Cord	TC-0065RX/3"
	999 816 499	463A to Alligator Clips 16" Cord	TC-W463EF

Ph: 1-800-526-2673

[www.westek.com](http://www.westek.com)

Fax: 1-800-526-3299

# AT&T Replacement Cords

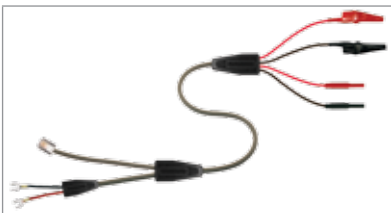
	SSI/PID #	Description	Part #
	001 522 150	Alligator Clips & Chuck Ends to RJ11 & Spade Lugs 8' Cord	TC-L1L7RJ11SL/8

## Banana Kit



KT Banana Kit  
SSI#11317835

RFL test set replacement cord kit  
(includes all three pictured cords)



TC-3300BPGN (5')  
R/A Banana Grn to LHTCABP Grn

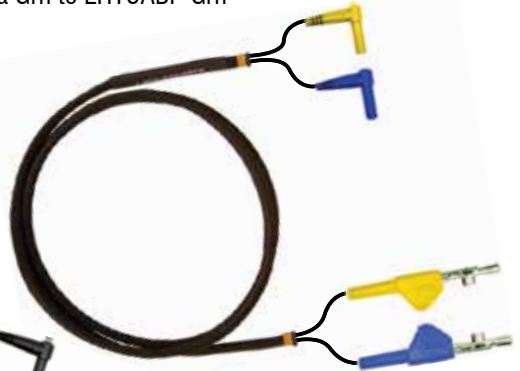

TC-3300BPYB (5')  
2 R/A Bananas Yel/Blu to 2  
LHTCABP Yel/Blu

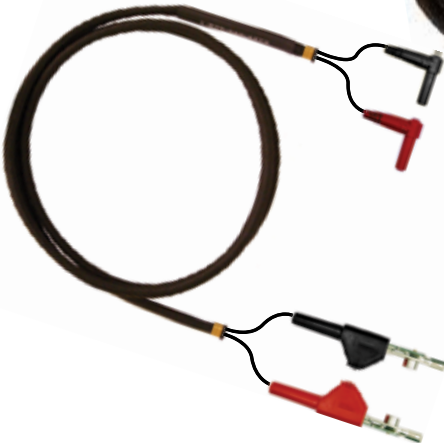

TC-3300BPRB (5')  
2 R/A Bananas Red/Blk to  
2 LHTCABP Red/Blk

# OSP Combi-Cord Verizon

Patent  
Pending

TC-OSPDEGH  
SSI# 11090301

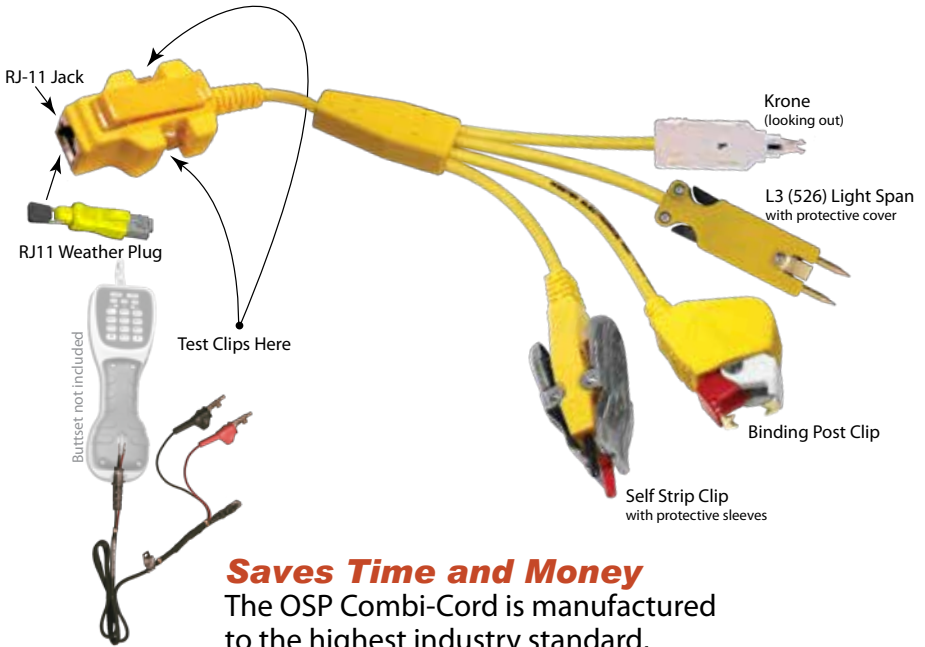

## **Saves Time and Money**

The OSP Combi-Cord is manufactured to the highest industry standard, proving itself to be ultra durable. Molded in bright yellow and is designed to fit in a tool pouch so it will not be misplaced.

***The OSP Combi-cord is available in 2 variations:***



Standard features with the recommended plug ends for 90% of field applications, and the Custom "built-to-suit" version to fit any field technician's special needs. Westek's OSP Combi-Cord features a 2 year warranty and excellent Westek Customer Service.

Ph: 1-800-526-2673

[www.westek.com](http://www.westek.com)

Fax: 1-800-526-3299

# OSP Combi-Cords

	SSI #	Description	Part #
	11090301	<b>Combi-Cord</b> Krone L3 (526) Light Span Binding Post Clip Self Strip Clip	TC-OSPDEGH
	11090300	<b>Combi-Cord</b> BIX Krone Porta Single Pin 5 Pin	TC-OSPDKMN

# OSP Combi-Cords

	SSI #	Description	Part #
	11090299	<b>Combi-Cord</b> 5 Pin 66 Block RJ45LE	TC-OSP CNP

OSP Combi-Cords	Part Number	SSI/PID
OSP Cord with Dual Bantam (Kit)	KT OSPBLN/IN	11260943
RJ11 w/pair Access Clip Y463A (L4), (2) Chuck ends (L7), Bantam	TC-OSPBLN/IN	
RJ11 w/pair Access Clip Y463A (L4), 526A (L3), (2) L7 Chuck ends	TC-OSPBGN/IN	11259741
RJ11w/pair access clip Y Self Strip, Binding Post, DatTerm,110D	TC-OSPAEFH	11259567
OSP w/ Banjo (Kit)	KT PDPQT	11260997
RJ45,Y RJ45, RJ11, Krone, 110	TC-PDPQT	
RJ11 w/Pair Access Clip Y Looking In, 463A (L4),66 Block & RJ45	TC-OSPCNP	11090299
RJ11 w/Pair Access Clip Y Looking In, 463A (L4), Porta, (L8), Krone, Bix	TC-OSPDKMN	11090300
RJ11 w/Pair Access Clip Y Self Strip, Binding Post, Krone & 526A	TC-OSPDEGH	11090301
RJ11 w/Pair Access Clip Y Self Strip, Binding Post, Krone, 66Block	TC-OSPCDEH	11183571
RJ11 w/Pair Access Clip Y Self Strip, Krone, RJ11	TC-OSPDHQ	11183572



# Buttset Replacement Cord TC 162202



Buttset not included



TS44

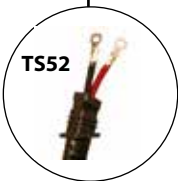

TS52

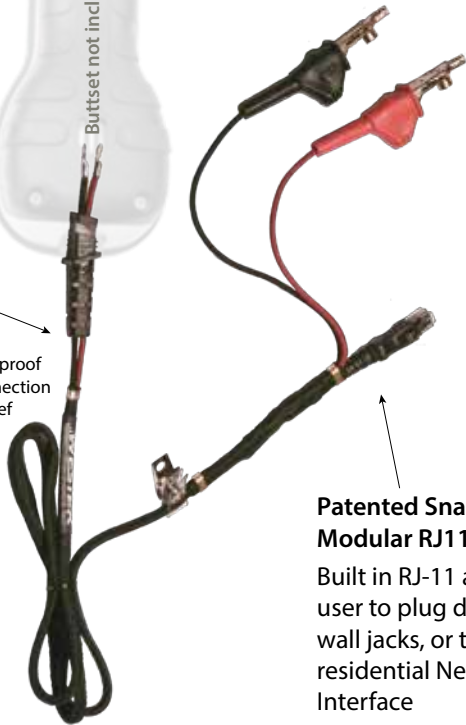

Patented Waterproof  
Line-Cord Connection  
With Strain Relief



Patented Snagless  
Modular RJ11 L-Plug  
Built in RJ-11 allows the  
user to plug directly into  
wall jacks, or the  
residential Network  
Interface

Call for Verizon SSI#

# Modular Cords

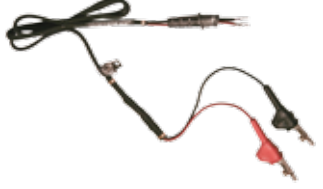
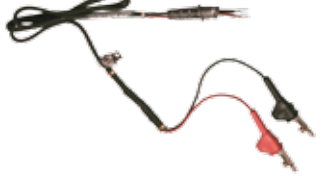
	SSI #	Description	Part #
	Call for PID#	Hardwires to TS-44 and TS52 Buttset w/ RJ11 to plug direct to wall jacks, or residential Network Interface	TC-162202
	Call for PID#	Hardwires to TS-22 Buttset w/ RJ11 to plug direct to wall jacks, or residential Network Interface	TC-162209
	Call for PID#	Hardwires to TS-22 Buttset	D1 250208
	Call for PID#	Hardwires to TS-44 Buttset	D1 250211

# Modular Cords

SSI #	Description	Part #	
	<p>Call for PID#</p>	<p>New Patented Replacement Cables for Six Position Banjo</p> <p>3" Cord 6" Cord</p>	<p>KT-RJ11LE5PK/3 KT-RJ45LE5PK/6</p>



# Modular Cords

	SSI #	Description	Part #
	Call for PID#	POTS testing Data testing	TC-BJ100-Pro

## Banjo Pro

Three tools in one.

Patent  
Pending

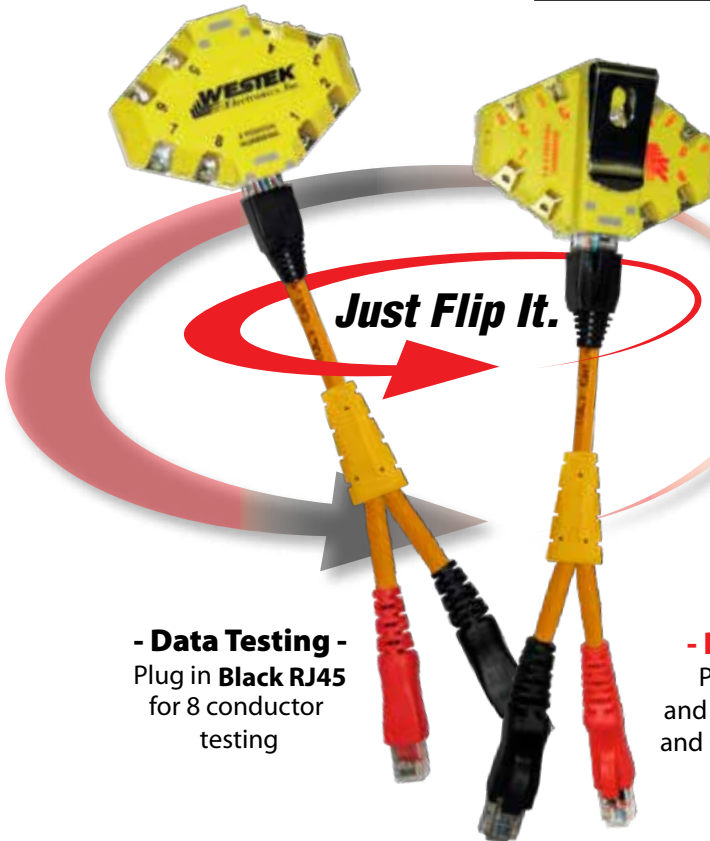

Save money, time,  
and space with  
the three in one  
convenience of  
Westek's  
NEW *Banjo Pro!*  
Featuring our  
**Unbreakable  
Banjo Pro Cable**

**- Data Testing -**  
Plug in **Black RJ45**  
for 8 conductor  
testing



**- POTS Testing -**  
Plug in **Red RJ11**  
and "Just Flip It" for 2, 4  
and 6 conductor testing

Ph: 1-800-526-2673





www.westek.com

Fax: 1-800-526-3299



# 463A Cords

	<b>SSI/PID #</b>	<b>Description</b>	<b>Part #</b>
	110 189 25	463A (ring) Resistance Bridge 8' Red Cord	TC 161774
	110 189 26	463A (tip) Resistance Bridge 8' Cord	TC 161777
	700 254 100	463A Short to No End 20' Cord	D1 250133/20

# 463A Cords

	SSI/PID #	Description	Part #
	001 492 289	463A to 463A 12' Cord	TC-463A/12
	872 168 33	463A Frogging Cord 8' Cord	TC-5PFROG
	110 189 23	463A Shorting Tool Black	TC 161771
	110 189 24	463A Shorting Tool Red	TC 161768

# Adapters

	SSI/PID #	Description	Part #
	001 237 114	Female 463A to Porta 1' Blue Cord	TC-AD303TX
	001 237 122	Female 463A to Porta 1' Red Cord	TC-AD303RX
	700 249 492	Hardwire to Quick Disconnect 346A 16" Cord	TC-H2C

# Adapters

	SSI/PID #	Description	Part #
	001 412 360	BNC to 358 Adapter	TC-AD358
	001 412 378	BNC to 440 Adapter	TC-AD440
	700 251 184	BNC Coupler	TC-BNCCPLR
	001 412 410	9 pin Female to 9 pin Female Low Profile Gender Changer	TC-GCPC9F
	001 412 428	9 pin Male to 9 pin Male Low Profile Gender Changer	TC-GC9M
	001 412 436	25 pin Male to 25 pin Male Low Profile Gender Changer	TC-GCPC25M

# Adapters

	SSI/PID #	Description	Part #
	001 412 444	25 pin Female to 25 pin Female Low Profile Gender Changer	TC-GCPC25F
	001 412 451	25 pin Null Modem Low Profile Adapter	TC-NM100LP
	001 412 469	9 pin Null Modem Low Profile Adapter	TC-NM900LP
	001 412 303	310 to Bantam Adapter Red	TC-AD310R
	001 412 311	310 to Bantam Adapter Blue	TC-AD310B
	110 189 28	Female 463A to RJ11 6" Cord	TC-TLTS 4A
	700 248 518	Adapter for SLC96	TC-SLC96

# TEL-LINE TESTER PRO KIT™

Troubleshoot Cable Pairs Fast and with Protection.



SSI# 11056256KT-291052

INCLUDED IN THE KIT:



Looping Tool



Grounding Tool

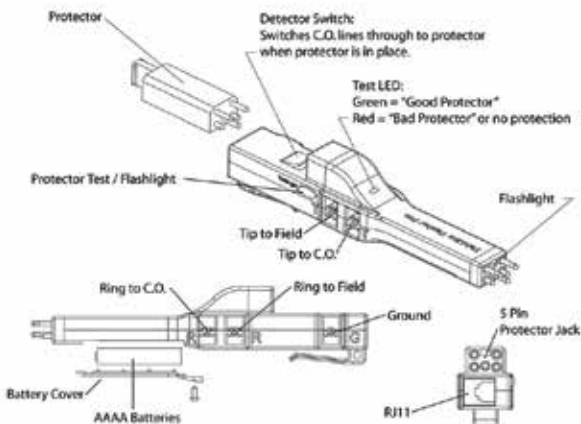

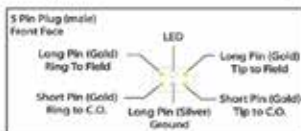

## PRODUCT HIGHLIGHTS

- Access 5 pin location at building entrance, CEV, SLC remote, and Central Office with protection
- Isolate Central Office from field
- No need to disconnect pairs
- Test Protector Modules
- Flashlight



# Testers

	SSI/PID #	Description	Part #
 <p>Protector Not Included</p>	11056256	Tel-Line Tester Pro Kit Includes Looping Tool and Grounding Tool	KT 291052
 <p>Protector Not Included</p>	11056255	Tel-Line Tester Pro Tester Only	TC-TLTS-PRO
	87057094	Short 463A to Protector Cradle 30" Cord	TC-L4PEXT/30"

# TEL-LINE TESTER™ KIT

## OSP Troubleshooting Kit

**Now Cable Maintenance Technicians Can Troubleshoot Cable Pairs Fast!**

Important time saving tool kit for cable maintenance. Now troubleshoot cable pairs in seconds and eliminate repeat repairs. Look into the central office or out to the field in seconds!

The Tel-Line Tester™ automatically splits the central office from the field! Access cable pairs by plugging into any five pin connector block located at the building entrance (SLC remote, CEV, or Central Office).

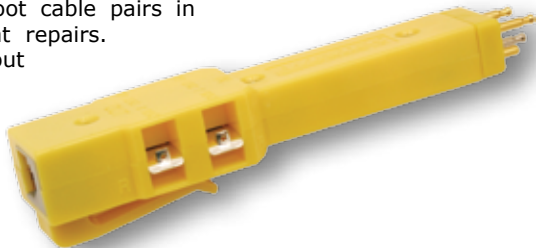

To troubleshoot the switch, simply clip a buttset or voltmeter to the metal tabs marked "Tip" and "Ring In" and look to the switch. Move the clips to the tabs marked "Tip" and "Ring Out" and look to the field. To restore temporary service to the customer while troubleshooting, simply plug in the OSP kit's modular looping tool. The Westek Tel-Line Tester™ facilitates Bell System Practice (BSP). Connect a Craft access terminal or Trans Test Access Network to close out the trouble and pull up the next job ticket.

### Tel-Line Tester™ Kit - TC-TLTS-2

Includes:  
Looping plug,  
Craft Access  
wall cord.



### Tel-Line Tester™ - TC-TLTS 1A



Tester unit only

### Product Highlights

Access 5 pin location at building entrance, CEV, SLC remote, and Central Office

Isolate Central Office from field



No need to disconnect pairs

Built tough and durable

Full two year warranty

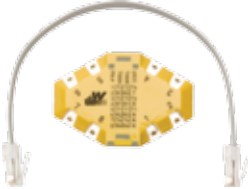

# Testers

	SSI/PID #	Description	Part #
	001 238 252	Tel-Line Tester only	TC-TLTS 1A
	110 189 27	Tel-Line Tester with ground connection	TC-TLTS-G
	001 492 255	Tel-Line Tester Kit	TC-TLTS-2
	001 492 347 581487	Banjo Modular Line Tester with RJ45 to RJ45 cord	TC-BJ100Y









Ph: 1-800-526-2673

[www.westek.com](http://www.westek.com)

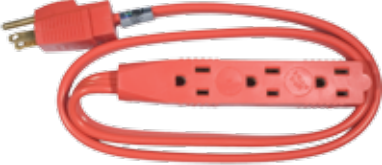
Fax: 1-800-526-3299

# Miscellaneous

	SSI/PID #	Description	Part #
	110 275 12	Web Slitter tool only	WS 340023
	001 492 370	Velcro Cinch Strap 15 pieces	TC-V15 BLK
	001 238 120	25' AC Power Cord 3 outlets 14 AWG	TC-PC01/25
	001 412 477	ESD Wrist Strap	TC-WS100
	700 243 084	Soft Carrying Case for DSX1	TC-P01
	001 412 329 110 189 29	Small Cord Bag Blue	CB 05190 000

### Verizon Coax Kit



Kit Contents	Part Number	SSI/PID
1 - BNC to BNC Red 8'	TC-500RX	001 412 352
1 - BNC to BNC Blue 8'	TC-500TX	001 412 345
2 - BNC to 358 Adapter	TC-AD358	001 412 360
4 - BNC to 440 Adapter	TC-AD440	001 412 378
2 - Female BNC to LCP 4"	TC 16298/4"	700 251 182
2 - Female BNC to LCC 4"	TC 16445/4"	700 251 183
4 - BNC Coupler	TC-BNCCPLR	700 251 184
1 - Cord Bag	CB 05190 000	001 412 329

### DS3 Kit



Kit Contents	Part Number	SSI/PID
1 - BNC to BNC Red 8'	TC-500RX	001 412 352
1 - BNC to BNC Blue 8'	TC-500TX	001 412 345
4 - BNC to 358 Adapter	TC-AD358	001 412 360
4 - BNC to 440 Adapter	TC-AD440	001 412 378
1 - Cord Bag	CB 05190 000	001 412 329

### DSO Kit



Kit Contents	Part Number	SSI/PID
1 - Bantam to Bantam Red 8'	TC-200RX	001 237 049
1 - Bantam to Bantam Blue 8'	TC-200TX	001 236 785
1 - Bantam to Angle Nose Heavy Test Clips with Bed of Nails 8' Red	TC-260LTB RX	001 238 153
1 - Bantam to Angle Nose Heavy Test Clips with Bed of Nails 8' Blue	TC-260LTB TX	001 238 146
1 - RJ48 to Y Bantam	TC-TR248S	001 464 692
1 - RJ45 to RJ45 10' Royal Blue Cat5 cord	TC-140	001 412 295
2 - 310 to Bantam Adapter Red	TC-AD310R	110 189 24
2 - 310 to Bantam Adapter Blue	TC-AD310B	110 189 23
1 - Cord Bag	CB 05190 000	001 412 329

**CO Bridging Kit**



Kit Contents	Part Number	SSI/PID
1 - Tel-Line Tester	TC-TLTS 1A	001 238 252
1 - Tel-Line Tester with Ground Connector	TC-TLTS-G	110 189 27
1 - 463A to RJ11	TC-TLTS 4A	110 189 28
1 - 463A Frogging Cord 8'	TC-5PFROG	872 168 33
1 - RJ11 Looping Tool	TC-TLTS-12	N/A
1 - Ground Start Cord	TC-TLTS-14	N/A
1 - 463A Shorting Plug Red	TC 161768	110 189 24
1 - 463A Shorting Plug Black	TC 161771	110 189 23
1 - 463A Resistance Bridge (ring)	TC 161774	110 189 25
1 - 463A Resistance Bridge (tip)	TC 161777	110 189 26
1 - Static Discharge Wrist Strap	TC-WS100	001 412 477
1 - Cord Bag	CB 05190 000	001 412 329

**T1 Kit for Central Office**



Kit Contents	Part Number	SSI/PID
1 - Bantam to Bantam 8' Red	TC-200RX	001 237 049
1 - Bantam to Bantam 8' Blue	TC-200TX	001 236 785
1 - Bantam to Bantam 8' Black	TC-200BLK	001 237 130
1 - Bantam to Bantam 8'	TC-200	007 242 963
1 - Bantam to 310 8' Red	TC-230RX	001 237 064
1 - Bantam to 310 8' Blue	TC-230TX	001 237 056
1 - 463A to Bantam 8' Red	TC-5P200RX	001 237 080
1 - 463A to Bantam 8' Blue	TC-5P200TX	001 237 072
1 - Porta to Female 463A 1' Red	TC-AD303RX	001 237 122
1 - Porta to Female 463A 1' Blue	TC-AD303TX	001 237 114
1 - Bantam to Wire Wraps 8' Red	TC-272RX	001 237 171
1 - Bantam to Wire Wraps 8' Blue	TC-272TX	001 237 155
1 - 463A to 463A 12'	TC-463A/12	001 492 289
2 - 310 to Bantam Adapter Red	TC-AD310R	001 412 303
2 - 310 to Bantam Adapter Blue	TC-AD310B	001 412 311
1 - Bantam to Alligators 8' Red	TC-260RX	001 238 153
1 - Bantam to Alligators 8' Blue	TC-260TX	001 238 146
1 - Alligator Clips to Minigrabbers 3" Red	TC-0065RX/3"	001 238 112
1 - Alligator Clips to Minigrabbers 3" Blue	TC-0065TX/3"	001 238 104
1 - Power Cord 25'	TC-PC01/25	001 238 120
1 - Cord Bag	CB 22000 000	N/A

**T1 Kit for Outside Plant**



Kit Contents	Part Number	SSI/PID
1 - Bantam to Bantam 8' Red	TC-200RX	001 237 049
1 - Bantam to Bantam 8' Blue	TC-200TX	001 236 785
1 - Bantam to Bantam 8' Black	TC-200BLK	001 237 130
1 - Bantam to Bantam 8'	TC-200	007 242 963
1 - Bantam to 310 8' Red	TC-230RX	001 237 064
1 - Bantam to 310 8' Blue	TC-230TX	001 237 056
1 - 463A to Bantam 8' Red	TC-5P200RX	001 237 080
1 - 463A to Bantam 8' Blue	TC-5P200TX	001 237 072
1 - Porta to Female 463A 1' Red	TC-AD303RX	001 237 122
1 - Porta to Female 463A 1' Blue	TC-AD303TX	001 237 114

Continued on next page.



**T1 Kit for Outside Plant (cont'd)**

Kit Contents (cont'd)	Part Number	SSI/PID
1 - Bantam to Wire Wraps 8' Red	TC-272RX	001 237 171
1 - Bantam to Wire Wraps 8' Blue	TC-272TX	001 237 155
1 - 463A to 463A 12'	TC-463A/12	001 492 289
2 - 310 to Bantam Adapter Red	TC-AD310R	001 412 303
2 - 310 to Bantam Adapter Blue	TC-AD310B	001 412 311
1 - Bantam to Angle Nose Heavy Test Clips with Bed of Nails 8' Red	TC-260LTB RX	001 238 153
1 - Bantam to Angle Nose Heavy Test Clips with Bed of Nails 8' Blue	TC-260LTB TX	001 238 146
1 - Female Bantam to Krone 1' Red	TC-925F RX/1	001 238 179
1 - Female Bantam to Krone 1' Blue	TC-925F TX/1	001 492 321
1 - Female Bantam to 66 Block Adapter 1' Red	TC-266F RX/1	001 492 339
1 - Female Bantam to 66 Block Adapter 1' Blue	TC-266F TX/1	001 238 187
1 - RJ45 to Y Bantam 8'	TC-TR248C	001 238 203
1 - 15 pin Female to Y Bantam 8'	TC-15F200	001 238 211
1 - 463A to Dual Bantam 15' Red	TC-5P250RX/15	700 248 005
1 - 463A to Dual Bantam 15' Blue	TC-5P250TX/15	001 238 229
1 - Banjo Modular Line Tester	TC-BJ100	001 492 347
1 - Alligator Clips to Minigrabbers 3" Red	TC-0065RX/3"	001 238 112
1 - Alligator Clips to Minigrabbers 3" Blue	TC-0065 TX/3"	001 238 104
1 - Tel-line Tester unit	TC-TLTS 1A	001 238 252
1 - Female Bantam to Bix 1' Red	TC-297 RX/1	001 492 362
1 - Female Bantam to Bix 1' Blue	TC-297 TX/1	001 492 354
1 - Female Bantam to 110 1' Red	TC-210F RX/1	001 238 294
1 - Female Bantam to 110 1' Blue	TC-210F TX/1	001 238 286
1 - Power Cord 25'	TC-PC01/25	001 238 120
15 - Velcro Cinch Straps	TC-V15 BLK	001 492 370
1 - Cord Bag	CB 22000 000	N/A

### Laptop Kit



Kit Contents	Part Number	SSI/PID
1 - DB9 Male to Male Gender Changer	TC-GC9M	001 412 428
1 - DB9 Female to Female Gender Changer	TC-GCPC9F	001 412 410
1 - 9 Pin Null Modem Adapter	TC-NM900LP	001 412 469
1 - DB25 Male to Male Gender Changer	TC-GCPC25M	001 412 436
1 - DB25 Female to Female Gender Changer	TC-GCPC25F	001 412 444
1 - 25 Pin Null Modem Adapter	TC-NM100LP	001 412 451
1 - ESD Wrist Strap	TC-WS100	001 412 477
1 - DB9 Male to DB9 Pin Female 10'	TC-9M9F/10	001 412 402
1 - DB9 Female to 25 Pin Male 10'	TC-25M9F/10	001 412 394
1 - Storage Pouch	CB 05190 000	001 412 329

### Web Slitter Kit



Kit Contents	Part Number	SSI/PID
Web Slitter tool	WS 340023	110 275 12
Aerosol Biolube	WS 340026	110 275 13
Acorn Nut replacement	WS 340047	110 275 20
Knob replacement	WS 340062	110 275 25
Retaining Clip replacement	WS 340053	110 275 22
Threaded Spacer replacement	WS 340044	110 275 19
Bronze Bushing replacement	WS 340050	110 275 21
Clevis Pin replacement	WS 340059	110 275 24
Dowel replacement	WS 340056	110 275 23
Guide Wheel replacement	WS 340041	110 275 18
Screw replacement	WS 340038	110 275 17

TEST RIGHT THE FIRST TIME.

## VERIZON

TC-TLTS-PRO  
SSI# 11056255

KT 291052  
SSI# 11056256

Kit includes:



## TEL-LINE TESTER PRO™

Troubleshooting cable pairs  
has never been this easy!

- Access 5 pin location at building entrance, CEV, SLC remote, and Central Office with protection
- Isolate Central Office from field
- No need to disconnect pairs
- Test Protector Modules
- LED Flash Light

\* PROTECTOR NOT INCLUDED



One service call, one van, one test cord.  
The OSP Combi-Cord.

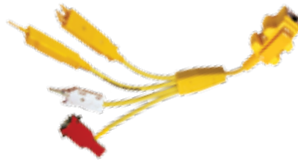

The OSP Combi-Cord is manufactured to the highest industry standard, proving itself to be ultra durable. **The OSP Combi-Cord is available in many variations:** Standard features with the recommended plug ends for 90% of field applications, and the Custom “built-to-suit” version to fit any field technician’s special needs. Westek’s OSP Combi-Cord features a 2 year warranty and excellent Westek Customer Service.



Ph: 1-800-526-2673

[www.westek.com](http://www.westek.com)

Fax: 1-800-526-3299

# THE FASTEST ROUTE FROM DESIGN TO PRODUCTION

*Westek's engineering team can put a working model in your hands!*

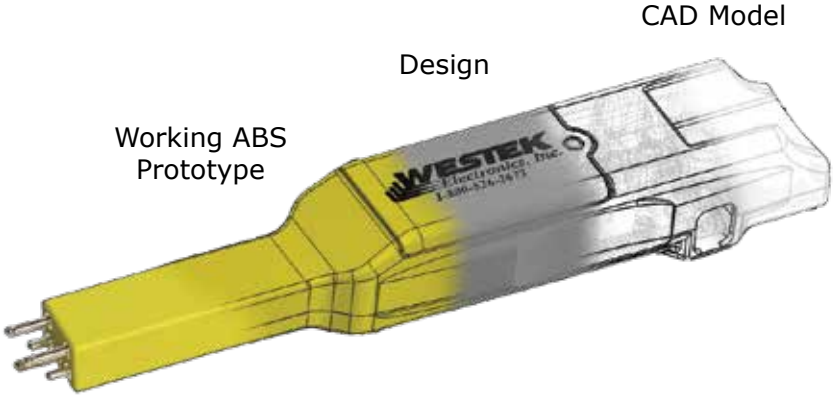

Nothing communicates design ideas faster than a three-dimensional part or model.

Westek can bring your CAD files and design ideas to life. Test form, fit and function using as many design iterations as you need with functional ABS parts to beat your competitors to the marketplace.

Unlike appearances prototypes produced in weak materials, our 3D printer will generate durable, working models in ABS (acrylonitrile butadiene styrene) plastic. ABS 3D models can withstand rigorous functional testing. ABS is the material of choice by leading manufacturers and is a major reason why our prototypes resemble a finished product.



# Can't Find The Cable You're Looking For?



## ▶ Contact Us!

Westek cable specialists are available Monday through Friday, from 7am to 4pm Pacific Standard Time to assist you with higher quality cables, cost reduction, and engineering support!

800.526.2673



Ph: 1-800-526-2673

[www.westek.com](http://www.westek.com)

Fax: 1-800-526-3299







To succeed in this information and communication driven world, you need reliable products and world class support. Westek is committed to providing quality products, on time delivery and unbeatable customer support. Thank you for being a valued customer. [800.526.2673](tel:800.526.2673)



**WESTEK**  
Electronics, Inc.  
[www.westek.com](http://www.westek.com) | 800.526.2673

**30 years of Excellence in Connectivity!**



185 Westridge Drive, Watsonville, CA 95076  
Phone 800.526.2673 Fax 800.526.3299