

銀箭牌

WWW.SIRUBA.COM



SIRUBA

2022 GENERAL
CATALOGUE



將縫紉之美傳至世界各地

DELIVER THE BEAUTY OF SEWING TO ALL OVER THE WORLD

從扛著一台台縫紉機問候客戶的當年，到成為臺灣第一領導品牌的現在，
每一個腳步都述說著高林堅持不懈，任重道遠的使命感

From the earliest day we carried sewing machines to visit clients on foot,
and now we have become the top leading brand in Taiwan.

Every step we made, presents our solid, unswerving, and responsible commitment.

History

1965 高林股份有限公司正式成立
Kaulin Mfg. Co., Ltd. was founded.

SIRUBA

第一代品牌標誌
First LOGO

1971 工業用手提式縫袋口機上市
Introduced industrial portable bag closer machine to the market.

1981 推出工業用超高速拷克車系列產品
Introduced industrial ultra high-speed Overlock machines.

1991 工業用三針繃縫機系列產品成功應市
Introduced industrial 3-Needle Interlock sewing machine.

1994 榮獲商檢局「ISO-9002」國際品保系列認證通過開發四針與十二針環縫車(VC008)系列產品成功
Passed ISO-9002 International QA System Certification.
Introduced 4 and 12-Needle cylinder bed Chainstitch machine (the VC008 Series).

1996 四針平車(HF008系列)開發成功應市
Introduced 4-Needle Double Chainstitch machine (the HF008 Series).

1998 企業識別(CIS)更新
Corporate Identity System updated.

SIRUBA
建商紳工業用縫紉機
INDUSTRIAL SEWING MACHINE

2000 股票上市 (TWSE 1531)
Stock listed in Taiwan Stock Exchange Market. (TWSE 1531)

2005 擴大企業生產規模，投資設立寧波高林銀箭機電有限公司
Kaulin Machinery & Electronic industrial (Ningbo) Co., Ltd., was established.

2007 榮獲外貿協會第四屆「臺灣優良品牌」；「臺灣精品獎」等獎項

Granted "Taiwan Superior Brands", "Taiwan Excellence" Award, by the Ministry of Economic Affairs.



2011 獲頒「臺灣百大品牌」殊榮，並參與「臺灣精品二十周年暨臺灣百大品牌特展」

Awarded "Top one hundred of Taiwan brands" by Ministry of Economic Affairs.

TOP 100
TAIWAN BRANDS



SIRUBA

2013 高林文創基金會成立
Kaulin Foundation established.

2014 成立「縫紉自動化」研發部門
"Sewing Automation Department" established.

2015 推出ASP-EBJ100等數台縫紉自動化設備
Launched "ASP-EBJ100" and various automatic sewing machines.

2016 原有南崁廠為擴大生產規模，搬遷至桃園新廠
Taiwan factory transferred from Nankan to Taoyuan for production scale expanding.

2017 推出集大成的最新款700L包縫機
Launched 700L, the overlock/safety stitch machine which compiles SiRUBA's finest overlock know-how.

2018 SiRUBA ICT 資通訊客戶服務發展平台元年
First year of SiRUBA ICT Customer Service Platform Development and Implementation.

2019 越南子公司成立於河內
SiRUBA Machinery Vietnam CO., LTD. was founded in Hanoi.

2020 胡志明辦公室成立
Ho Chi Minh City Liaison Office established.



最初推出的包縫機
First Overlock Machine



最初推出的雙針平車
First Two needles
Lockstitch Machine



AA-6



700L



C007LX



NC008



ASV-ATS100A

SIRUBA



一指搞定

One click to all access

SIRUBA Connect Service 給您全方位的VIP體驗

SIRUBA官方專屬APP「SiRUBA Connect」，可以讓您快速瞭解縫紉機產品的生產履歷，同時可讓您迅速流覽產品相關檔案。您也可以利用APP進行產品的線上客戶服務。

SIRUBA Connect Service provides you exclusive VIP experience

SiRUBA official APP "SiRUBA Connect", provides convenient doorway to view sewing machine's product history. You can also explore related product documents, and use this app to report to our customer service.



android



ios



android(China)

Download SIRUBA CONNECT SERVICE APP



無遠弗屆

Service beyond boundaries

SIRUBA 網路商務全面上線

您可以從我們的官方網站上進入我們的網路商務平台，輕鬆下單縫紉機與相關零件。
所有商品都井然有序地分類陳列，並讓您透過零件系列圖，迅速地找到您所需要的商品。

SIRUBA E-commerce website launched

Now you can do easy order-placing through our E-commerce website, to buy sewing machines and parts.
All merchandise are sorted in user-friendly order, and there are parts lists you can refer to find desired item quickly.

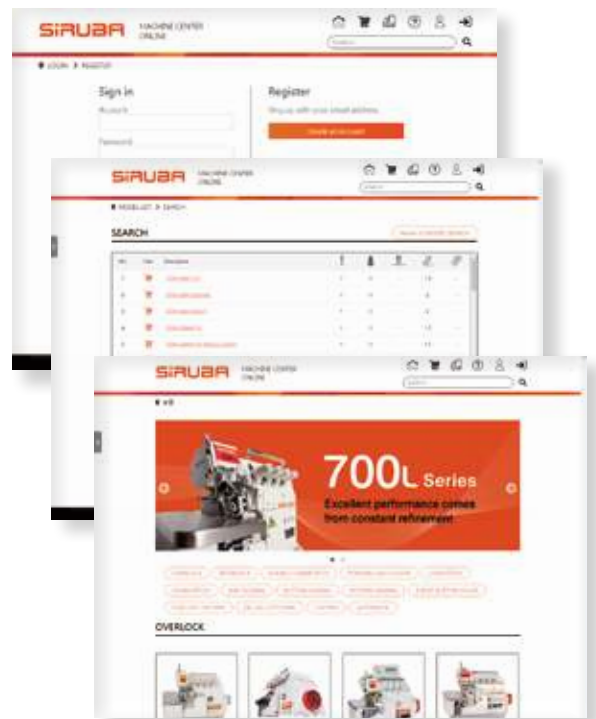

MACHINE CENTER ONLINE



PARTS CENTER ONLINE













	製衣工程 APPLICATION	▶ PAGE	2
	PROTECTIVE WEAR / T-SHIRT / POLO SHIRT / SWIMMING WEAR / RIBBED / LINGERIE / MEN'S BRIEF / SPORTSWEAR / SHIRT / LADIES' OUTWEAR / MEN'S TROUSERS / JEANS		
	自動化 AUTOMATIC SEWING	▶ PAGE	13
	ASP-EBJ Series / ASV-ATS100 Series / ASK-ASM101 / ASK-ASM200 / ASC-TBH200 / ASP-PTA 101 / ASO-STM100 / ASO- ABF100		
	包縫機  Device	▶ PAGE	31
	OVERLOCK STITCH MACHINE 700LQ / 700L / 700KS / 700KST / 700KT		
	繃縫機  Device	▶ PAGE	65
	INTERLOCK STITCH MACHINE C007L / C007LX / C007KP / U007 / S007K / F007K		
	多針鏈縫機  Device	▶ PAGE	116
	MULTI-NEEDLE / PICOTING CHAINSTITCH MACHINE VC008A / VC008B / HF008A / NC008 / Z008		
	平縫機 LOCKSTITCH MACHINE	▶ PAGE	140
	DL720 / DL7200C / DL7200D / DL7500 / DT828 / DT828L		
	電子花樣機 / 鎖眼機 / 套結機 / 釘扣機 COMPUTER-CONTROLLED CYCLE MACHINE	▶ PAGE	156
	PS Series / BT Series / BH-9820 Series / LBHS-1790D / LKS-1900D		
	四針六線併縫機 4-NEEDLE 6-THREAD FLATSEAMER	▶ PAGE	172
	D007SP / D007SXP / D007RB		
	其他 OTHER	▶ PAGE	179
	LZ Series / DL3880 Series / AA		

TABLE OF SPECIFICATION SYMBOLS



針數
Number of needles



壓具揚程
Presser foot lift



自動切線功能
Thread trimmer



線數
Thread numbers



針板
Needle plate



針距
Max. feeding amount



針距
Needle gauge



切邊距離
Gauge width



最高擺針
Max zigzag width

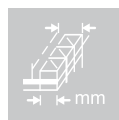

包邊寬度
Overedge width

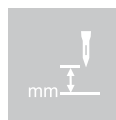

針棒高度(mm)
Needle bar height



縫距
stitch length



車縫距離
stitch length



針棒行程(mm)
Needle bar stroke



包裝尺寸
Package Size



差動比
Differential feed ratio



拉布輪數
Puller numbers



重量
Weight



使用針型號
Type of needle

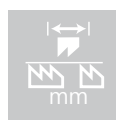

上送具行程
Top Feeding Function



切刀尺寸
Knife size



車縫速
Sewing speed

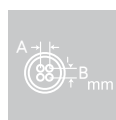

孔位尺寸
Button sewing size



馬達
Motor



鈕釦尺寸
Button size



General Seaming:

Closing hood, Sleeve, Leg & etc.

737L-504M-3-04

747L-514M-3-24

757L-516M-3-35



Zipper Attaching

DL7200C

DL7200D

DL7500

DL720



• **Hot Air Sealing**

DM-HT-SEALER-A2-PG(Brand: NPI)



• **Elastic Tape Attaching**

737L-504M-3-04/LFC-3

747L-514M-3-24/LFC-3

747L-514M-3-24/SMK

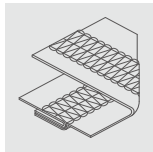

C007KP-W322-356/CC

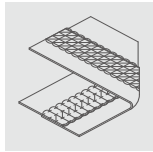

D007SP

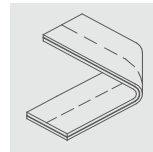

DL7200C
DL7200D
DL7500
DL720

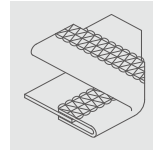

700KS/ACS
700KS/RSK
C007KP-W222-356/CQ
F007K-W222-356/FQ

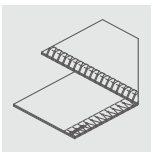

747L-514M-7-23/BK
747L-514M-3-23/BKF
747L-514M-3-24/BKT

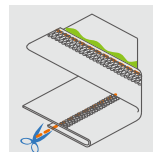

ASC-TBH200
C007KP-W812A-356/CRL
C007L-W812A-356/CRL/RL

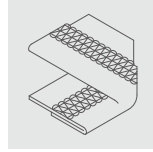

C007KP-W122-356/CH
F007K(D)-W122-356/FHA
C007L/LX-W122-356/CH

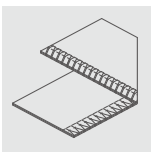

747L-514M-3-24

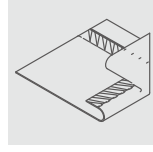

737L-505F-2-04

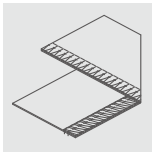

737KS(T)
747KS(T)

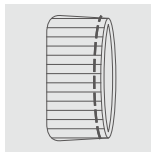

ASK-ASM101

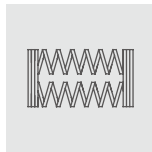

LBHS-1790D

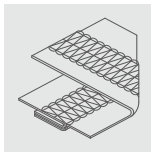

C007KP-W322-356/CE
C007L/LX-W322-356/CE

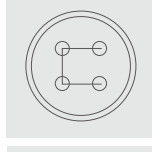

ASO-ABF100
LKS-1903D

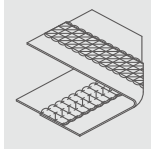

D007SP

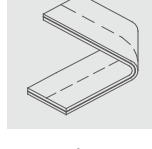

DL7200C
DL7200D
DL7500
DL720

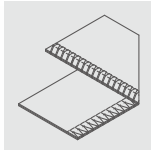

747L-514M-3-24/TG

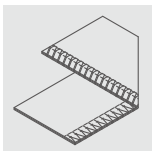

747L-514M-3-24
747L-514M-7-23/BK
747L-514M-3-23/BKF
747L-514M-3-24/ECA/BKT

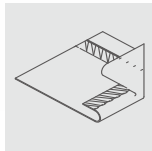

737L-505F-2-04

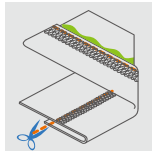

C007KP-W812A-356/CRL
C007L/LX-W812A-356/CR

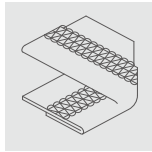

C007KP-W122-356/CH
C007L/LX-W122-356/CH

POLO SHIRT

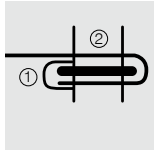
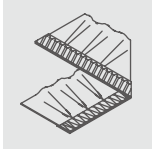

737KS(T)
747KS(T)
747L-514M-3-24/LFC-3
747L-514M-3-24/LFD-6
C007KP-W122-356/CH
C007L/LX-W122-356/CH

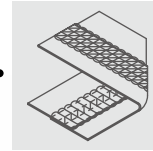

D007SP



SWIMMING
WEAR

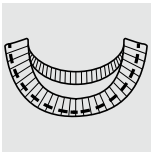

747KST-514M-3-24/VT/ACS

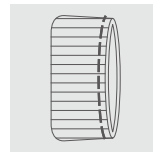

ASK-ASM101



ASK-ASM200

RIBBED

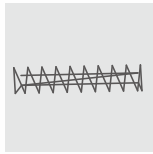

LKS-1900D

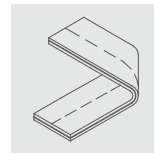

DL7200C
DL7200D
DL7500
DL720

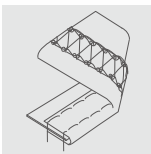

F007K-W522-232
/FR/FQS

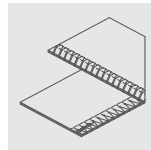

747L-514M-7-23/BK
747L-514M-3-23/BKF
747L-514M-3-24/ECA/BKT

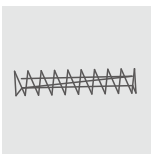

LKS-1900D

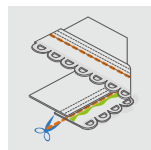

C007KP-W522-356/CR/FFC
F007K-W522-356/FR/FFC

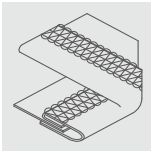

C007KP-W152-356/CZ/RLQ

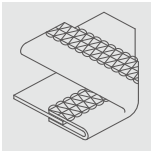

C007KP-W222-356/CQ
F007K-W222-356/FQ

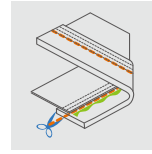

C007KP-W532-356/CR/CX/UTP/RLP

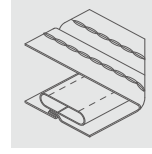

F007K-U712(A)-264/FSP
F007K-U712-496/FSS

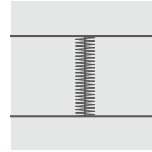

ASP-EBJ100
ASP-EBJ200

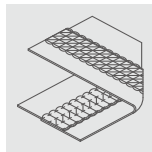

D007SP
F007K-W922-456/FW
C007KP-W922-456/CW



LKS-1900D

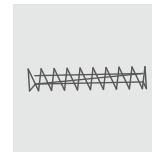

LKS-1900D

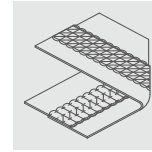

D007SP
F007K-W922-456/FW
C007KP-W922-456/CW

MEN'S BRIEF

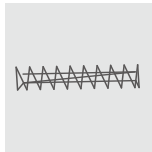

LKS-1900D

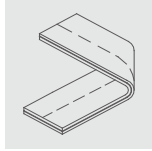

DL7200C
DL7200D
DL7500
DL720

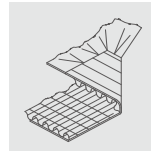

VC008A-04095P/VWL
VC008A-04095P/VWLB
VC008A-04095P/VWLC

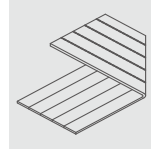

VC008A-04085P/VCE
VC008B-04085P/VCE

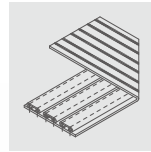

VC008A-06048P/VPL
VC008B-06048P/VPL

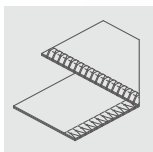

747L-514M-3-24

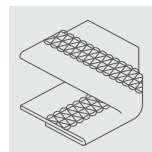

C007KP-W122-356/CH
C007L/LX-W122-356/CH

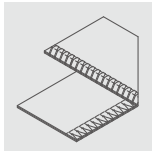

757L-516M-3-35

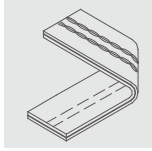

DL3882

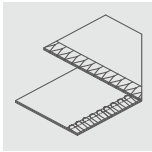

747L-514M-3-24

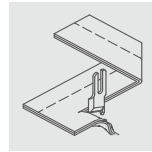

DL7200C-RM1

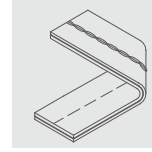

DL3881

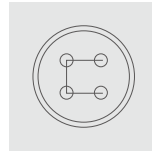

**ASO-ABF100
LKS-1903D**

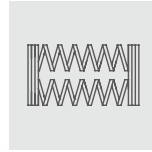

LBHS-1790D

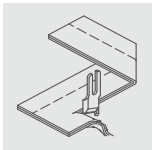

DL7200C-RM1

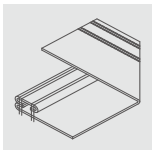

VC008A-0464-191P/VSF

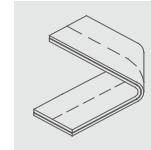

**DL7200C
DL7200D
DL7500
DL720**

SHIRT

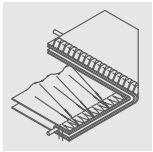

747L-514M-8-24/GA

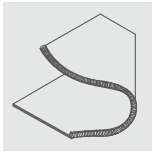

737L-504F-2-02/GAL

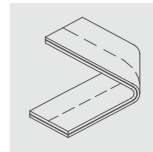

**DL7200C
DL7200D
DL7500
DL720**

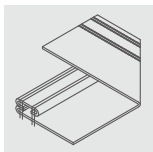

VC008A-0464-191P/VSF



LBHS-1790D

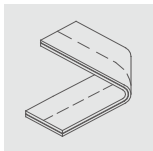

**DL7200C
DL7200D
DL7500
DL720**

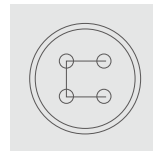

**ASO-ABF100
LKS-1903D**

LADIES' OUTWEAR

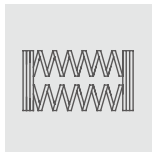

LBHS-1790D

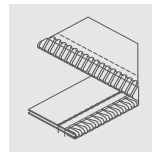

757L-516M-3-35/PS
757L-401M-8-50/TA

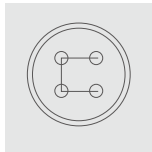

ASO-ABF100
LKS-1903D

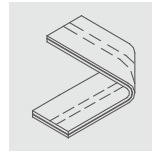

DT828
DT828L

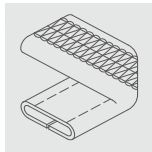

F007K(D)-U613-256/FBP

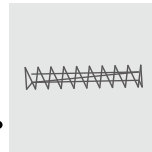

LKS-1900D

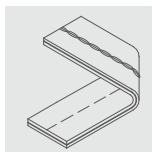

DL3881



BH-9820

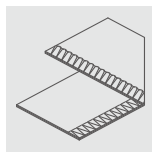

737L-504M-3-04
757L-516M-3-35

MEN'S TROUSERS

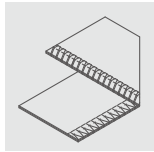

757KT-516M3-56-CT

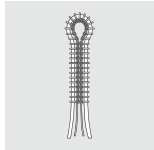

BH-9820

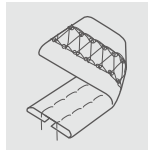

HF008A-02064P/FBQ/C



**HF008A-0664-254P/HPR
NC008**

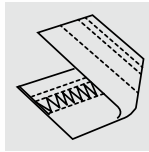

F007K-W722-388/FY



LKS-1900D-HS

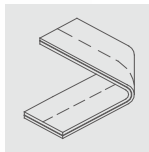

DL7200C-BX2-16

AUTOMATIC SEWING

AS P - EBJ 100 / □□ / C

搭配機種 Model
P 電腦車 Programmable Bar-Tacker
L 平車(單) Single-Needle Lockstitch
K 拷克車 Overlock
V VC008
C C007
F F007

功能 Function
EBJ 自動鬆緊帶搭接機 Automatic Elastic Ring Making Machine
ATS 100 自動三貼條車縫機 Three-Strip Attaching Multi Needle Sewing Machine
ASM 101 自動羅紋上袖口/褲腳機 Automatic Ribbed Cuff Attaching Machine
ASM 200 自動羅紋下擺機 Automatic Ribbed Hem Attaching To Wide Waistband Machine
TBH 200 自動T恤下擺折縫機 Automatic T-shirt Bottom Hemming Machine
PTA 101 自動上紙標機 Automatic Paper Tag Attaching Machine
STM 100 自動穿繩機 Automatic String Thrusting machine
ABF 100 自動送扣裝置 Auto Button Feeder

選配件
Optional Device

機型編號
Model Number

客制化
Customized



SIRUBA
Automatic Sewing

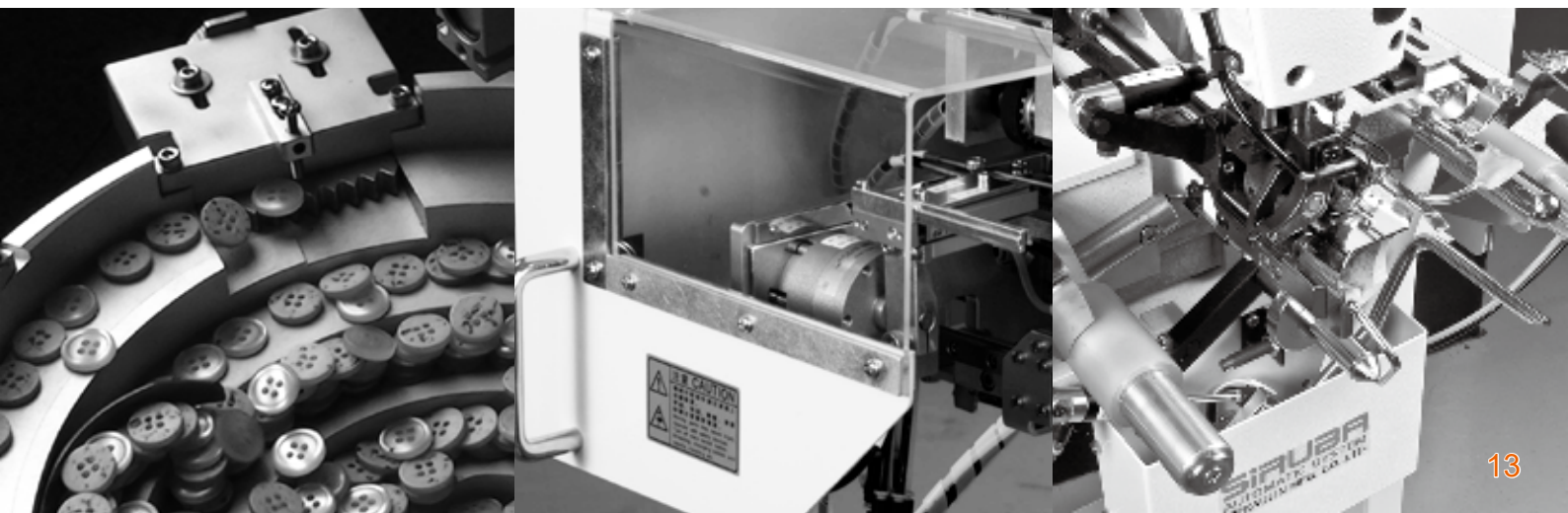

ASP-EBJ SERIES

自動鬆緊帶搭接機

Automatic Elastic Ring Making Machine



ASP-EBJ100A



ASP-EBJ150



ASP-EBJ200

特點

FEATURES

1 EBJ系列實現全自動鬆緊帶車縫。量測·裁剪·送料·車縫一系列連續動作·具有絕對的穩定度·精準可靠
EBJ Series realizes automatic sewing of elastic band. Measuring, cutting, feeding, and sewing are in sequence with absolute stability. It is accurate and reliable.

2 無人化生產·成品良率高·投資回收期短·最慢一年即可回收
Unmanned Production with high yield rate. Payback period is short as maximum 1-year ROI.

3 採用高階感知器·靈敏偵測入料狀況·具有即時報警·自動暫停功能
By high-end sensors, it detects the feeding sensitively with real-time alarm and auto pause function.

4 可選配整燙裝置·確保入料前的平整度·解決皺褶或扭曲的問題
Pre-ironing device is optional, which it ensures the flatness when the material is entering, to solve the problem of wrinkles or twists.

5 可選配視覺辨識系統·偵測Logo並依設定位置裁剪與車縫
Visual identification system is optional, which detects Logo and then positions cutting and sewing according to user's setting.



影片連結
Video link



規格

SPECIFICATIONS

型號 Model	ASP- EBJ100A	ASP- EBJ100S	ASP-EBJ150	ASP-EBJ200
縫紉機機頭 Machine Head	JUKI LK-1920		JUKI LK-1920	JUKI AMS210ENSS
車縫速度 Sewing Speed	2500 SPM (最高 Max)			2800 SPM (最高 Max)
使用針型 Needle Type	DP×5 #14			DP×17 #14
線跡形式 Stitch type	單針鎖縫 #301 Single Needle Lockstitch #301			
鬆緊帶寬度 Rubber Width	20~50 mm	6~20 mm	20~50 mm	20~90 mm
車縫花型儲存 Pattern Memory	EEPROM			IP-420 (JUKI AMS)
最大儲存車縫花型數量 Max. Numbers of Pattern	99 種車縫花型 99 Patterns			999 種車縫花型 999 Patterns
切帶方式與材料 Tape Cutting Method	刀切 Knife Cutting			◎刀切 Knife Cutting △超聲波 Ultrasonic Cutting
生產效率 Production Capacity	視縫製針數而定 舉例: 190針縫製樣式的情形 下, 迴圈時間: 8秒/件; 3600 件/ 8小時 Depends on the stitch pattern, Ex: 190 stitches pattern, Cycle Time: 8 Sec./ pcs (Max.); 3600 pcs/ 8Hr	視縫製針數而定 舉例: 71針縫製樣式的情形 下, 迴圈時間: 6秒/件; 4800 件/ 8小時 Depends on the stitch pattern, Ex: 71 stitches pattern Cycle Time: 6 Sec./ pcs(Max.); 4800 pcs/ 8Hr	視縫製針數而定 舉例: 190針縫製樣式的情形下 迴圈時間: 8秒/件; 3600件/ 8小時 Depends on the stitch pattern Ex: 190 stitches pattern as below Cycle Time: 8 Sec./ pcs(Max.); 3600 pcs/ 8Hr	
縫紉尺寸 Stitch Length	<p>重疊 0~13mm Lapping 0~13mm</p> <p>平折長度 150~990mm flat folding length 150~990mm</p>			
氣體消耗量 Air Consumption	30 公升/分 30 L/Min.			
氣壓 Air Pressure	0.5 MPa			
電源電壓 Power Supply	Single Phase 1Φ AC200~240V 50/60Hz			
消費電力 Power consumption	750 W (Max)	750 W (Max)	800 W (Max)	800 W (Max)
機器尺寸 Dimensions	(W)1230X(D)1030X(H)1530mm (With table and thread stand 含桌板、線架)			(W)1550X(D)1150X(H)1530mm (With table and thread stand 含桌板、線架)
選配裝置 Optional Device				
收料裝置 Stacker	△	△	△	△
熱整燙裝置 Pre-Ironing	—	—	△	△
LOGO 辨識裝置 LOGO Identification	—	—	◎	◎

◎ 標配 Standard

△ 選配 Option

ASV-ATS SERIES

自動三貼條車縫機

Three-Strip Attaching Multi Needle Sewing Machine

影片連結
Video link



特點

FEATURES

1 特殊設計壓腳·快速縫合防止皺褶·可依不同特性進行調整(AT100A)
Custom-designed presser foot for Adidas 3-stripe sewing. Puckering free and adjustable. (AT100A)

2 雙電眼控制·可減少廢料·節省人工裁切收料時間
Dual-sensor control to reduce material waste and save cutting/collecting time.

3 最短收料長度150mm
Minimum finished length:150mm

4 三顆馬達·獨立控制送帶·張力控制精準
Stripe feeding controlled by individual motors for a better feeding performance.



規格

SPECIFICATIONS

型號 Model	ASV-ATS100A / ASV-ATS100C	
是否有特殊壓腳 Custom-designed presser foot	ASV-ATS100A：有 Yes	ASV-ATS100C：無 No
縫紉機機頭 Machine Head	SiRUBA VC008-06064P/VPL	
車縫速度 Sewing Speed	2000 SPM (最高Max)	
使用針型 Needle Type	UO×113GS #11	
車縫平台寬度 Available Width of Stitching Platform	440 mm	
縫紉針距 Stitch Length	6.4 mm	
生產樣式 Sewing Pattern	<p>可調 (Adjustable)</p>	
氣體消耗量 Air Consumption	40公升/分 40 L/min	
氣壓 Air Pressure	0.5 MPa	
電源電壓 Power Supply	Single Phase 1Φ AC200~240V 50/60Hz	
消費電力 Power Consumption	800 W (Max)	
機器尺寸 Dimensions	(W)1200×(D)900×(H)1900 mm (With table and thread stand含桌板、線架)	
生產效率 Production Capacity	車縫布長：600mm計算、縫距：2 mm、 車縫速度：1500 SPM、產速：3 件/min Cloth length：600mm、Stitch pitch：2 mm、 Sewing speed：1500 SPM、Output：3 pcs/min	

※收料限制：布料長度 150 mm 以上

※Material limit : essential requirement cloth length \geq 150 mm

ASK-ASM101

自動羅紋上袖口/褲腳機 Automatic Ribbed Cuff Attaching Machine

影片連結
Video link



特點

FEATURES

- 1** 自動過骨感知偵測 · 設定結尾需求針數
Auto seam detector, easy to set up the stitches after seam.
- 2** 快速調整機構 · 方便設定與維護
Quick adjustment mechanism, easy for setting and maintenance.
- 3** 張力調整 · 自動拉伸 · 減少布料起皺
Tension controller for smooth feeding and puckering free.
- 4** 防內捲裝置 · 減少內捲不良率
Anti-curly edge device reduce sewing defects.

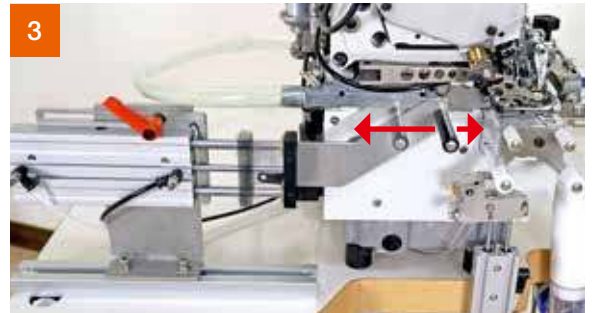

規格

SPECIFICATIONS

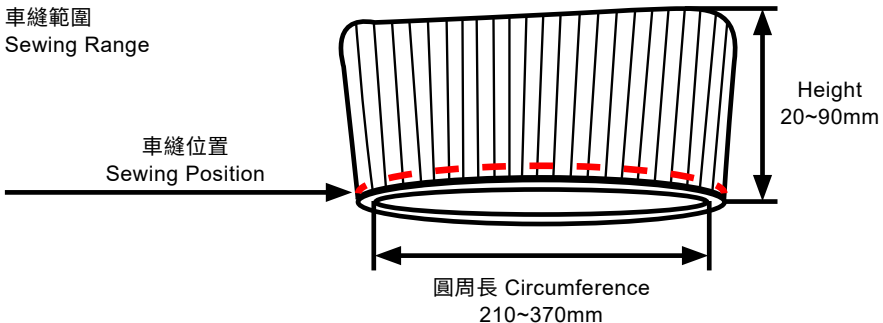
型號 Model	ASK-ASM101
縫紉機機頭 Machine Head	SiRUBA 747KST-514M-3-24
車縫速度 Sewing Speed	5500 SPM (最高Max)
使用針型 Needle Type	DC×27 #11
壓腳高度 Presser foot Height	8.5 mm (最高Max)
包邊寬度 Overedge Width	4 mm
縫紉針距 Stitch Length	2 mm
羅紋布尺寸 (mm) Rib Size (mm)	 <p>車縫範圍 Sewing Range</p> <p>車縫位置 Sewing Position</p> <p>圓周長 Circumference 210~370mm</p> <p>Height 20~90mm</p> <p>※羅紋布口徑與布身口徑相差需在40mm內，布身布厚>0.9mm，彈性布料。 ※The difference between the caliber of the ribbed fabric and the caliber of the fabric body should be within 40mm, and the fabric thickness of the fabric body should be greater than 0.9mm. Elastic fabric.</p>
布厚範圍 Fabric Thickness	6.5mm
氣體消耗量 Air Consumption	180公升/分 180 L/min
氣壓 Air Pressure	0.5 MPa
電源電壓 Power Supply	Single Phase 1Φ AC200~240V 50/60Hz
消費電力 Power Consumption	500 W (Max)
機器尺寸 Dimensions	(W)825×(D)640×(H)1622mm (With table and thread stand 含桌板、線架)
生產效率 Production Capacity	200~240 件/小時 (車縫速度：3000 spm，羅紋布尺寸 圓周長：270mm，高度：60mm) 200~240 PCS/Hour (Sewing Speed: 3000 spm, Rib Size: Circumference: 270mm, Height: 60mm)

ASK-ASM200

自動羅紋下擺機 Automatic Ribbed Hem Attaching Machine



特點

FEATURES

1

撐布：可以依照商品需求做尺寸設定
Fabric tension: Can be adjust according to product requirements.

2

穩布：搭配Sensor穩布輪可將布邊穩定在 $\pm 2\text{mm}$ 內，使其送布量與切布量穩定
Fabric stability: Using sensor stabilizing wheel can stabilize the cloth edge within $\pm 2\text{mm}$, makes the feeding and cutting stable.

3

骨位偵測：螺紋布骨位自動感測定位功能
Seam detection: Automatic sensing positioning function for rib fabric seam.

4

疊縫設計：布料骨位感知偵測，簡單設定結尾疊縫需求針數
Overlapping stitching: End overlapping stitching counts can be simply set up by fabric seam detection sensor.

1



3

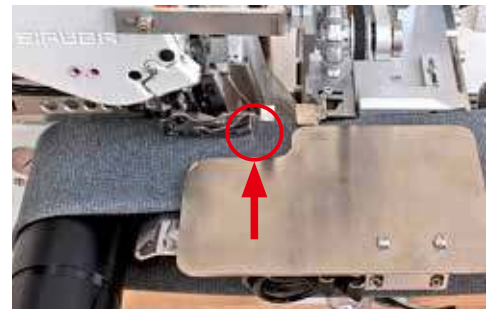

2



4



規格

SPECIFICATIONS

型號 Model	ASK-ASM200	
縫紉機機頭 Machine Head	SiRUBA 747KST-514M-4-24	
車縫速度 Sewing Speed	4500 SPM (最高Max)	
使用針型 Needle Type	DC×27 #11	
壓腳高度 Presser foot Height	7 mm	
包邊寬度 Overedge Width	6 mm	
縫紉針距 Stitch Length	0.5~6 mm	
羅紋布尺寸 (mm) Rib Size (mm)	<p>車縫範圍 Sewing Range</p> <p>車縫位置 Sewing Position</p> <p>寬幅 Width 35~55mm</p> <p>圓周長 Circumference 860~1480mm</p> <p>*帶口袋之衣款不適用 *Garment with pocket not applicable</p>	
布厚範圍 Fabric Thickness	6.5 mm (Max)	
氣體消耗量 Air Consumption	400公升/分 400 L/min	
氣壓 Air Pressure	0.5 MPa	
電源電壓 Power Supply	Single Phase 1Φ AC200~240V 50/60Hz	
消費電力 Power Consumption	1K W (Max)	
機器尺寸 Dimensions	(W)1300×(D)790×(H)1640 mm (With table and thread stand 含桌板、線架)	
生產效率 Production Capacity	車縫速度：22 sec/pc (4500 spm，羅紋布尺寸 圓周長：980mm，高度：55mm) Sewing Speed: 22 sec/pc (4500 spm, Rib Size: Circumference: 980mm, Height: 55mm)	

ASC-TBH200

自動T恤下擺折縫機 Automatic T-shirt Bottom Hemming Machine



特點





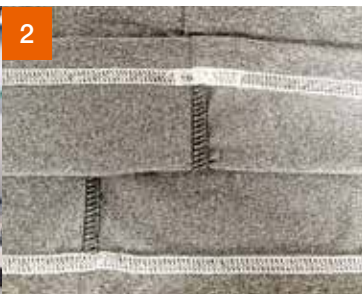

FEATURES

- 1** 專利導向輪模仿人工手勢，使布料糾偏功能更強大，面料適應性更寬廣。
The patented guide wheel simulates operator's gestures, it makes the machine operating smoothly during the sewing, and applicable for more kinds of fabric.
- 2** 專利吹氣倒縫功能，真正實現多骨位同方向倒縫。
Patented air-blowing reverse stitching function makes side seams reverse stitching in the same direction.
- 3** 起縫和結束線跡完全對齊。
The start and end stitches are perfectly aligned.
- 4** 設備自帶衣服大小碼自動調節功能，避免生產中出現混碼而導致縫製錯亂。
The equipment comes with an automatic adjustment function of clothes size, which avoids confusion in sewing caused by mixed sizes in production.
- 5** 38-90公分的縫製範圍，可以真正的實現XS到5XL自由切換。
The sewing range of 38-90 cm can sew sizes in between XS to 5XL.
- 6** 適用於筒狀或已包邊縫的全自動折下擺車縫。
Fully automatic hemming is suitable for tubular materials or materials with overlock seams.
- 7** 可以做第一或最後工序的操作。
It can be the first stage or last stage of production process.
- 8** 100%棉質紗線的高速車縫。
High-speed sewing with 100% cotton thread.
- 9** 一人可操作多台機器，降低人工縫製難度標準化生產，無需技能工操作。
Machine operators can handle more than one machine simultaneously. Reducing the difficulty of manual sewing and standardizing production, without the need for skilled workers to operate.



規格

SPECIFICATIONS

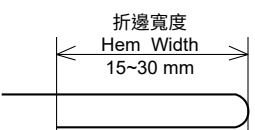
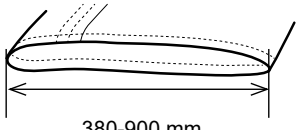
ASC-TBH200	Needle No.	 mm	 mm	 mm	 S.P.M. (Max)	 mm	 KG
	UY128		折邊寬度 Hem Width 15~30 mm	標配：5.6， 訂購時可選配 4.0 / 4.8 / 6.4 Normal standard: 5.6 Optional by ordering 4.0 / 4.8 / 6.4	0.3~4.5	4500	L1200 W1200 H1670
生產能力 Capability of Output	80~120 pcs/ hour		適用周長(攤平) Circumference of T-shirt bottom(Flattened)	 380-900 mm 對折中心距 Folding center distance			
電源 Power supply	AC 220V，50/60Hz						
工作氣壓 Air Pressure	4 bar						
耗氣量 Air Consumption	190 L / min						
縫紉機機頭 Machine Head	標配：上送筒型 / Normal standard: Top feed cylinder bed type C007KP-W812A-356/CRL/UTP						
標配倒骨 Standard seam guide function	要求正、反縫位都可以採用此設備縫製（帶真倒骨功能） It can be used to sew both front and back stitching positions (with true back stitch function)						
IOT物聯對接（選配）	IOT interconnection (Please select it when ordering)						
掃線裝置 Sweep the line device	吹氣裝置（標配），電磁鐵勾線裝置（選配） Standard configuration: blowing device Optional Configuration: Electromagnet wire hooking device						

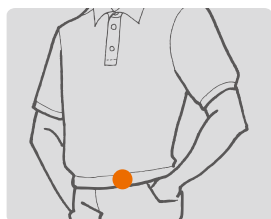

ASP-PTA101

自動上紙標機 Automatic Paper Tag Attaching Machine



特點

FEATURES

- 1 彈性卡槽 · 方便調整 · 最高容量250張(厚度0.5mm)
Paper card loader is flexible for easy adjustment.
The capacity is up to 250 pieces.
- 2 旋轉缸更平滑與穩定 (ASP-PTA101)
Smooth and stable rotary cylinder
- 3 利用快拆裝置 · 快速調整紙卡尺寸
Card spec easy to adjust by quick release device.
- 4 單件車縫的週期時間 · 約為3-5秒鐘
Cycle time 3-5 sec
- 5 儲氣筒(選配) · 解決氣源不穩的問題
Air Tank (Option), solution to the unstable air supply.



規格

SPECIFICATIONS

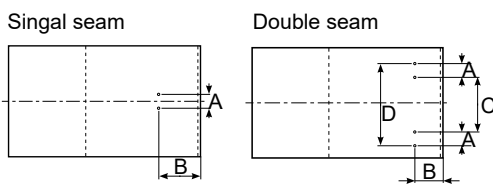
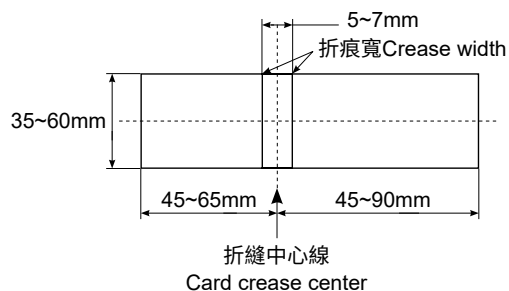
型號 Model	ASP-PTA101
縫紉機機頭 Machine Head	SiRUBA LKS-1903AN
車縫速度 Sewing Speed	2000 SPM (最高Max)
使用針型 Needle Type	DP×17 #11
紙卡單邊長 Card Length	Left 45~65 mm, Right 45~90 mm
紙卡寬度 Card Width	35~65 mm
折痕寬度 Crease Width	5~7 mm
紙卡厚度 Card Thickness	0.4~0.6 mm
車縫範圍 Sewing range	 <p> Singal seam A 3~6mm B 15~30mm </p> <p> Double seam A 3~6mm×2 B 10~25mm C 20~30mm D ≤40mm (考慮縮放比例 Consider scale size) </p>
適用紙卡規格 Card dimensions	 <p> 5~7mm 折痕寬 Crease width 35~60mm 45~65mm 45~90mm 折縫中心線 Card crease center </p>
氣體消耗量 Air Consumption	2 L/min
氣壓 Air Pressure	0.5 Mpa
電源電壓 Power Supply	Single Phase 1Φ AC200~240V 50/60Hz
消費電力 Power Consumption	660 W (Max)
機器尺寸 Dimensions	(W)1050×(D)705×(H)1530 mm (With table and thread stand 含桌板、線架)

ASO-STM100

自動穿繩機

Automatic String Thrusting
machine



影片連結
Video link



特點

FEATURES

適用於平頭鎖眼、鳥眼繡孔、金屬氣眼孔的穿繩工藝

Suitable for flat bottom hole, bird eye embroidery hole, metal air hole string technology.



80~180%
效率分析
Efficiency analysis



Before 20~32s
人工作業勞動強度大·效率低
Manual work quickly tired and low efficiency



After 9~12s
自動化設備作業·低疲勞度、效率高
Automated equipment operation, low fatigue,
high efficiency

規格

SPECIFICATIONS

型號 Model	ASO-STM100		
適用孔眼 Applicable hole	切口 incision $\geq 5\text{mm}$ 	直徑 diameter $\geq 5\text{mm}$ 	直徑 diameter $\geq 5\text{mm}$ 
適用帶繩 Suitable for rope	平頭眼 Flat button hole 	鳥眼繡 Bird's Eye Embroidery 	金屬氣眼 Metal eyelet 
噪音 Noise	<79dB		
腰圍 Waistline	80-170cm		
電源電壓 Power Supply	Single Phase 1 Φ AC200~240V 50/60Hz		
消費電力 Power Consumption	700 W (Max)		
重量 Weight	120Kg		
機器尺寸 Machine Dimensions	(W)1180×(D)580×(H)1750mm (含桌板、線架 With table and thread stand)		

※選購配件 Options	鋼絲規格 (耗材) Steel wire specification (Consumables)	
 提供童裝版元件 (選配) TKO1 Provide children's wear edition components (Optional) TKO1 適用腰圍尺寸 50~90cm 最小褲腰尺寸 50cm applicable waist size 50~90cm minimum waist size 50cm	 GS01 標準版彎彎鋼絲 (大頭) 約7-8mm孔眼 Standard edition bending steel wire (Large head) Coping with 7-8 mm hole.	 GS02 專用版折彎鋼絲 (小頭) 應對5-6mm孔眼 Special edition bending steel wire (Small head) Coping with 5-6mm hole.

ASO-ABF100

自動送扣裝置 Auto Button Feeder

ASO-ABF100J



ASO-ABF100B



特點

FEATURES

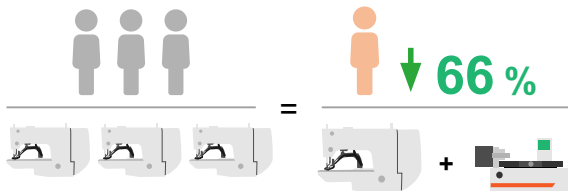

電子釘扣機附自動送扣比傳統縫扣機速度提升3倍
Button sewing machine with auto button feeder enhances 300% efficiency of button sewing.

循環時間: 2.2秒/顆; 13,090顆/ 8小時
Cycle Time: 2.2 Sec./Button; 13,090 Buttons/8 Hr



影片連結
Video link



操作面板

簡單圖像式操作介面·所有車縫所需資料·皆能清楚顯示

PANEL

User friendly interface, all sewing parameters are clearly shown.



感知器訊號檢測

透過操作面板A02功能·檢測感知器訊號正常

SENSOR SIGNAL DETECT

Checking the sensors detecting by A02 function of operation panel.



翻扣機制

自動吹風翻扣功能·提高大尺寸鈕扣(ø16mm以上)的精確性

FLIP MECHANISM

Flip mechanism enhance the accuracy of ø16mm up button by auto air-blow.



鈕扣夾爪自動感知器

可鈕扣夾爪偵測鈕扣位置·避免空縫

SMART SENSOR OF BUTTON CLAMP

Button clamp can detect the button position and avoid sewing without button.



送扣軌道調整

送扣軌道調整由步進馬達精準控制

BUTTON CHANNEL ADJUSTMENT

Channel adjustment is controlled by stepping motor accurately.



單鍵退扣

按鍵即可清空軌道內鈕扣

DISCHARGING

Press the key and then remove all the buttons in the channel.



電子式自動量測鈕扣

精準、極速，短時間內即可完成更換鈕扣設定

ELECTRONIC AUTOMATIC MEASUREMENT OF BUTTON SIZE

Accurate, Ultrafast, adjusting different button in a short time.

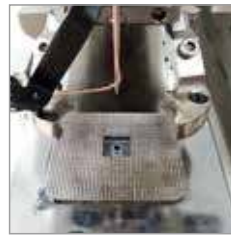

機頭上鈕扣夾爪

變換鈕扣尺寸時，鈕扣夾爪無須變更調整

BUTTON CLAMP OF MACHINE HEAD

Button clamp is suitable for variety button size, the clamp can be used in different button size and no further adjustment needed.



送扣載具模組化

可因應不同鈕扣規格，快速更換適合的送扣載具

BUTTON CARRIER MODULE

Modularized button carrier is for different button size and replacement.



ABF-J(B)安裝

簡易、快速安裝

INSTALLATION

Easy and friendly installation.

規格

SPECIFICATIONS

型號 Model	ABF100J	ABF100B
適用車頭 Apply For	Juki LK-1903A/LK-1903B/ LK-1903AN	Brother 438FX
工作夾具提升量 Rising Amount of Clamp	最大:13mm Maximum:13mm	
餵扣時間 Feeding Time	0.35~0.5秒 0.35~0.5 Sec.	
使用鈕扣 Button	種類：圓形平扣 尺寸:Φ8~26mm ※Ø10mm以下為特規，須更換規格件 Type: Circle Flat Button Size: Φ8~26mm ※Ø10mm is special specification, need to replace standard parts.	
使用扣孔 Button Hole	標準：2或4孔 選配：3孔 Standard: 2&4 Holes Option: 3 Holes	
鈕扣厚度 Thickness of Button	1.5~3.5mm	
氣體消耗量 Air Consumption	20公升/分 20 L/min	
氣壓 Air Pressure	0.5 MPa	
電源電壓 Power Supply	單相AC 200~240V 50/60Hz single-phase AC 200~240V 50/60Hz	
機器尺寸 Dimensions	寬 440 × 深 560 × 高 280mm 440(W)x560(D)x280(H)mm	

Remark:

標配：專用桌板、腳架、鈕扣壓腳、底板、大小鋸齒板及12組標準送扣載具使用
選配：3孔扣孔、對位器、雷射燈對位器

*鈕扣尺寸定義：

超小鈕扣尺寸Φ8~10mm，小鈕扣尺寸Φ10~20mm，大鈕扣尺寸Φ20~26mm
鈕扣夾爪適用範圍Φ8~26mm，但縫製超小或大鈕扣時，需視鈕扣厚度與凸面的情況

**大小鋸齒板選用建議

使用鈕扣	尺寸:Φ8~16mm	尺寸:Φ16~25mm
	小鈕扣鋸齒板	大鈕扣鋸齒板

Remark:

Standard: Professional table, All Set of Button Presser Foot ,Small/Big Button
Serrated Plate and Bottom Plate, 12 Sets of Standard Button Carrier.
Option : 3-Holed of Button Carrier,Button Spacer,Button Spacer with Laser Light.

*The definition of Button Size:

Extra small button size is Φ8~10mm, small button size is Φ10~20mm, and large button size is Φ20 ~ 26 mm. Basically, Button clamp of machine head is applied for Φ8~26mm, but that sewing extra/ large button size are depend on its thickness and convexity.

**Suggestion of selecting the serrated plate

Button	Size: Φ8~16mm	Size: Φ16~25mm
	The small serrated plate	The Big serrated plate

送釘載具模組規格

Button Carrier Specification

零件編碼 Codea of Parts	X $+0.05$ -0.05	D $+0.05$ -0.05	鈕扣孔數 Button Holes
ABF118	2.2	1.0	4
ABF119	2.2	1.0	2
ABF120	2.4	1.2	4
ABF121	2.4	1.2	2
ABF269	2.6	1.2	4
ABF270	2.6	1.2	2
ABF122	2.8	1.2	4
ABF123	2.8	1.2	2
ABF124	3.2	1.2	4
ABF125	3.2	1.2	2
ABF126	3.6	1.2	4
ABF127	3.6	1.2	2

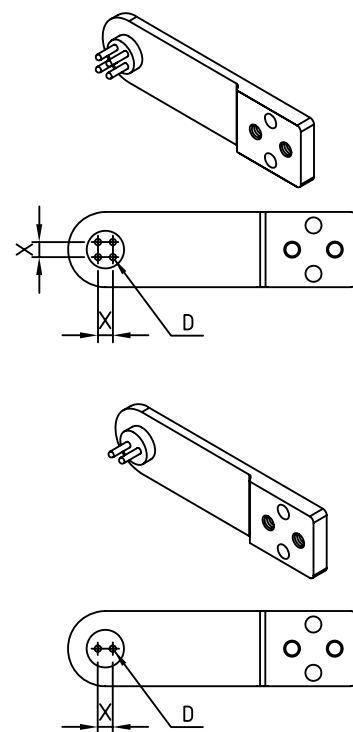

鈕扣型狀

Button Shape

適用鈕扣的形狀 Available Shape of Button	不適用鈕扣的形狀 Unavailable Shape of Button
<p>兩面須有明顯區別(落差)，凹或凸須在1.2mm差距以上，以順利判定正反面</p> <p>Two sides must be obviously different (Dissimilarity) For determining the positive or negative side, the convex or concave must above 1.2mm gap.</p>	<p>兩面皆相同之鈕扣，機器無法判別</p> <p>Machine can't work if one side of the button is identical to the other.</p>



OVERLOCK STITCH

700LQ 700L

747 L - 514 M - 2 - 2 4 / VT

①線數
Thread Numbers

737	: 3T
747	: 4T
757	: 5T
767	: 6T

⑥針距
Needle Gauge

⑦包邊寬度
Overedge Width

⑧配件
Device

②機種別
Model

LQ	機電一體 Mechatronic
L	基本型 Basic Type

③縫合方式
Sewing Types

503	
504	
505	
512	
514	
516	
644 (514+401)	

④車縫布料/上勾針縫容量
Sewing Fabric/Upper Looper Capacity

F	輕薄布料 Fine Weight Fabric
L	薄布料 Light Weight Fabric
M	中厚布料 Medium Weight Fabric
H	厚布料 Heavy Weight Fabric
X	特厚布料 Extra Heavy Weight Fabric

⑤送具型式
Feed Dog Type

2	2排 (標準) 2 Row (Standard)
3	3排 (標準) 3 Row (Standard)
4	4排 (標準) 4 Row (Standard)
6	1排 (特殊) 1 Row (Special)
7	2排 (特殊) 2 Row (Special)
8	3排 (特殊) 3 Row (Special)

OVERLOCK DD SERVO MOTOR

747L-514M-3-24 / ECA / DKL□□

⑨DKL□□ 700L型直驅電控組
Direct-Drive Servo Motor for 700L
請參閱P.39-40 Detail on Page.39-40

700LQ SERIES FEATURES



機電一體超高速包縫機

Mechatronic High Speed Overlock Stitch Machine

將高速直驅伺服馬達、電控箱、電源開關完全整合於縫紉機中，並支援多種選配功能，實現一體直驅化的包縫機。

Mechatronic overlock is an integration of motor controls system into SIRUBA high performance 700L overlock machine with multiple optional features support, a fully integrated all-in-one overlock.

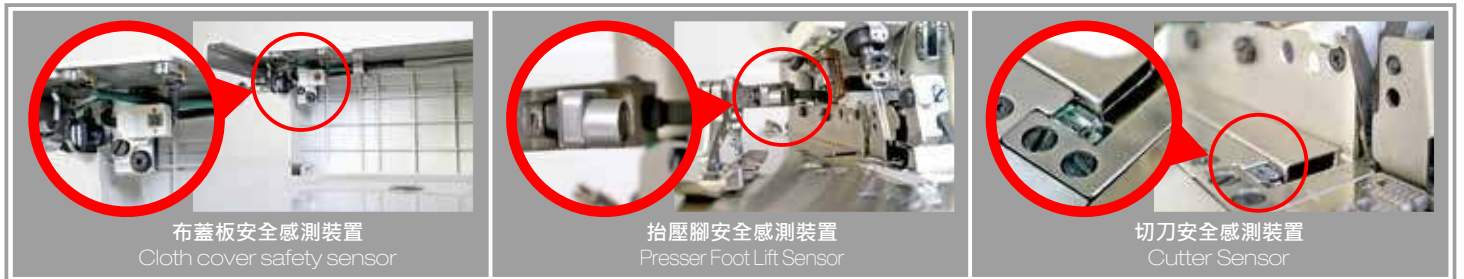
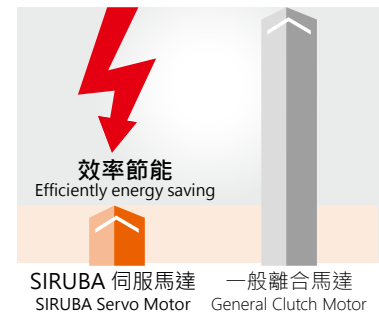

布蓋板安全感測裝置
Cloth cover safety sensor

抬壓腳安全感測裝置
Presser Foot Lift Sensor

切刀安全感測裝置
Cutter Sensor

1 智能化安全感測裝置

Intelligent Safety Sensor

2 全新觸碰式按鍵與液晶顯示面板

High performance touch button control panel

3 多國語言操作介面

User-friendly multilingual interface

4 高速穩定的伺服馬達運轉更平穩

High speed stable servo motor to ensure operational stability

5 多功能一體機型搭配更多元

Multi-function machine incorporated into intelligent mechatronic system delivers more energy-efficient motion as well as performance and reliability

6 微油潤滑技術提供乾淨清爽的縫製體驗

New oil lubrication technology provides experience of clean sewing without oil stains



規格 SPECIFICATIONS 747LQ - 514 M - 3 - 2 4 / ECA-U

規格索引，詳細請參考P.31 Specification index, please refer to P.31

- ① 線數 Thread numbers
- ② 機種別 Model
- ③ 縫合方式 Sewing types
- ④ 車縫布料/上勾針縫容量 Sewing Fabric/Upper Looper capacity
- ⑤ 送具型式 Feed dog type
- ⑥ 針距 Needle gauge
- ⑦ 包邊寬度 Overedge width
- ⑧ 配件 Device(on)

700LQ	布料厚度 Fabric Weight			①	⑥	⑦	S.P.M. (Max)	選購配件 OPTIONAL DEVICE					
	L	M	H										
737LQ-504M-3-04				1	2	-	4	0.7-2	3.6	6	#11	7000	ECA-U, ECB-U
747LQ-514M-3-24				2	4	2	4	0.7-2	3.6	5.5	#11	7000	ECA-U, ECB-U, VTE-U
757LQ-516M-3-35				2	5	3	5	0.7-2	3.6	5.5	#14	7000	ECA-U, ECB-U, CTE-U
767LQ-644M-3-324				3	6	3+2	4	0.7-2	3.6	5	#11	7000	

NOTE: For more information regarding the specification, please visit our website www.siruba.com

選購件 OPTIONAL ATTACHMENT

ECA-U 氣動式切刀
PNEUMATIC TYPE TAPE/THREAD CUTTER



自動切刀裝置
電眼偵測到布料前後邊緣時，切刀會精準下刀，自動切斷空車線。搭配吸風線槽，操作更順暢。

Automatic thread cutter device
When sensor detects the front and rear edges of the fabric, the cutter automatically will cut the thread. Compatible with air suction slot, which makes the operation more smoothly.



可調式電眼裝置
針對網紗、強反光絲光棉等特殊面料，採用專業的電控程式控制，均能輕鬆車縫及完成切線，不會造成切刀誤切。

Adjustable sensor device
For special fabrics such as mesh yarn and strong reflective mercerized cotton, professional electric control program is adopted, which can easily sew and complete thread trimming without causing cutting mistake.

ECB-U 電動式切刀
SOLENOID TYPE TAPE/THREAD CUTTER



手動切刀按鍵
如因操作問題沒有切斷線，可由此按鍵進行手動切線。

The button of manual cutter
Manual trimming compensation stitch button: If the thread was not cut due to the operation, it can be done by using manual cutter button.



自動抬壓腳裝置
腳踏板回踏，抬升壓腳，操作快速方便，減少不必要的體力消耗，製程速度產量加倍。

Automatic presser foot lifter
When the foot pedal is stepped back - the presser foot will raise. It can provide convenience for operation, reduces unnecessary physical exertion, and doubles the process speed and multiplied output.

VTE-U 垂直吸風切線 (附電眼節能裝置)
SIDE SUCTION CHAIN-CUTTER
(WITH SENSOR-CONTROLLED ENERGY)



VTE-U

CTE-U 水平式吸風切線 (附電眼節能裝置)
FLAT SUCTION CHAIN-CUTTER
(WITH SENSOR-CONTROLLED ENERGY-SAVING DEVICE)



CTE-U

電控系統支援電眼節能裝置，採用電眼偵測布邊，利用控制箱調整旋鈕，控制吸風功能在切線時運作，減少空壓設備的能源消耗，並避免縫線浪費。

Computerized system drives sensor-controlled energy saving device. Electric eye (sensor) checks the fabric edge. Turn the button of control box to set the time of air suction of chain-cutter. It saves the energy consuming of air compressor system and also saves thread consuming.

卓越性能 來自不斷的淬煉

Excellent performance comes from
constant refinement

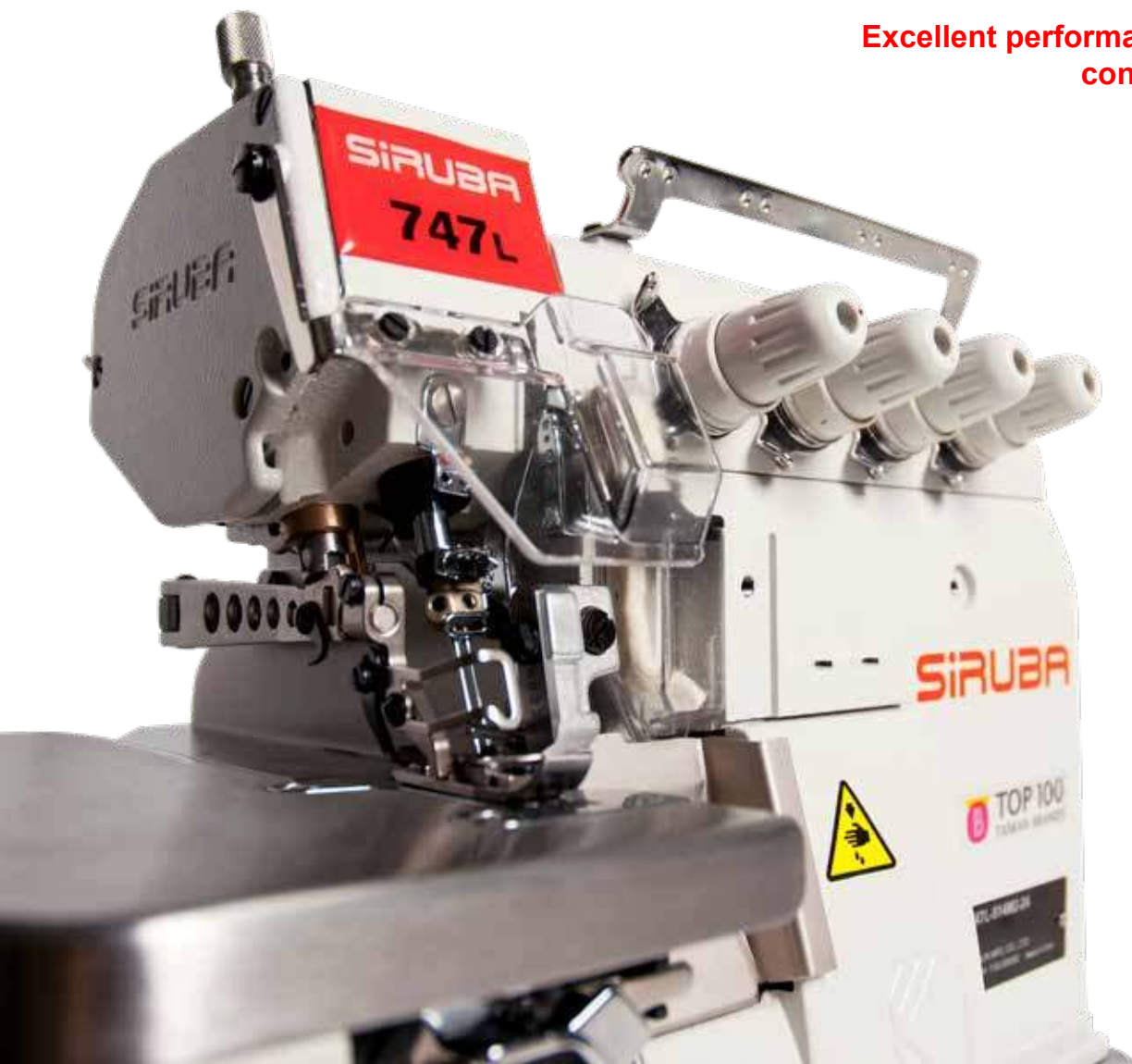

700L

超高速包縫 / 安全縫縫紉機

Ultra High Speed Overlock/Safety Stitch Machine



700L



700L series

在 SirUBA 包縫機技術的既有基礎上，大幅度提升性能

在控線與送布的根本性能的追求，實現了完美的縫紉品質

過線系統全面優化，在每一個細節都考慮了線的張力狀態，實現了極佳的控線能力。送具、壓具與切布刀的綜合調校，使得送布性能達到優化。在面料的厚薄適用性，700L在規格上有更全面的對應，實現了令人滿意的車縫品質

In pursuit of the core performance of thread controlling and fabric feeding, it realizes perfect sewing quality.

Threading system is fully optimized. As we fine-tuned every detail about the thread tension, it realizes a very good thread controlling. The feed dog, presser foot, and fabric trimmer are well coherent to make the fabric feeding optimized. Regarding the applicability range of fabric weight, 700L has a more comprehensive correspondence by specification, and realizes the satisfactory seam quality.

在機械精度的追求，達到高速運轉下的穩定性

提升零件的製造工藝，在精度、表面處理、內孔精加工和零件的輕量化設計，每一個細節都有嚴謹的配合，實現了高速、穩定、低噪音與低振動的機械性能

In pursuit of mechanical precision, it realizes the stability under high speed operation.

Improving the spare parts manufacturing process, the spare parts manufacturing process is improved. As the precision, surface treatment, micro-finish honing and parts light weight design are strictly coordinated in details, it realizes the high speed, stable, low noise and vibration mechanical performance.

車縫應用的範圍更寬

針對車縫面料的厚度，在規格上 (包括規格組、上勾針行程、機構時位...等) 有更全面的對應，在超薄或超厚的車縫情形，都有令人滿意的車縫品質

The bigger range of sewing application

Regarding sewing material thickness, we have a full specification (including gauge set, upper looper stroke, mechanical timing... etc) to satisfy customer requirement. We provide the nice seam quality in sewing fine or extra heavy material.

700L		布料厚度 Fabric Weight											
		L	M	H									
一般包縫 General Seaming	737L-503M-3-04				1	3	-	4	0.7-2	3.6	6	#11	7500
	737L-504F-2-04				1	3	-	4	0.7-2	3.6	5	#11	7500
	737L-504M-3-0⑦				1	3	-	4,5	0.7-2	3.6	6	#11	7500
	747L-512M-3-25				2	4	2	5	0.7-2	3.6	5.5	#11	7500
	747L-512M-3-34				2	4	3	4	0.7-2	3.6	5.5	#11	7500
	747L-514M-3-2⑦				2	4	2	3,4,5	0.7-2	3.6	5.5	#11	7500
	747L-514H-3-28				2	4	2	8	0.7-2	3.6	4	#11	6500
	757L-516L-2-24				2	5	2	4	0.7-2	3.6	5.5	#14	7500
	757L-516L-2-35				2	5	3	5	0.7-2	3.6	5.5	#14	7500
	757L-516M-3-35				2	5	3	5	0.7-2	3.6	5.5	#14	7500
	757L-516M-3-55				2	5	5	5	0.7-2	3.6	5.5	#14	7500
	767L-644M-3-324				3	6	3+2	4	0.7-2	3.6	5	#11	7000
	767L-644M-3-524				3	6	5+2	4	0.7-2	3.6	5	#11	7000
細包縫 Fine Edging	737L-504F-2-02/GAL				1	3	-	2	0.7-2	3.6	5	#9	7500
	737L-504F-2-15				1	3	-	1.5	0.7-2	3.6	5	#9	7500
	737L-504M-2-15				1	3	-	1.5	0.7-2	3.6	6	#9	7500
肩帶包縫 Tape Inserting	747L-514M-3-2⑦/TG				2	4	2	4,5	0.7-2	3.6	5.5	#11	7500
拷下擺 Blind Hemming	737L-505F-2-04				1	3	-	4	0.7-2	3.6	5	#9	7500
鬆緊帶車縫 Elastic Attaching	737L-504M-3-04/LFC-3				1	3	-	4	0.7-2	3.6	6	#11	4500
	737L/WR/LFC-3				1	3	-	-	-	-	-	#11	4500
	747L-514M-3-2⑦/LFC-3				2	4	2	4,5	0.7-2	3.6	5.5	#11	4500
摺景車縫 Gathering	747L-514M-8-24/GA				2	4	2	4	0.7-2	3.6	5.5	#11	7000
	757L-516M-8-35/GA				2	5	3	5	0.7-2	3.6	5.5	#14	7000
	757L-516M-8-55/GA				2	5	5	5	0.7-2	3.6	5.5	#14	7000
手動線頭包縫 Manual Back Latching Seaming	737L-504M-7-04/BK				1	3	-	4	0.7-2	3.6	6	#11	7500
	747L-514M-7-2⑦/BK				2	4	2	3,4	0.7-2	3.6	5.5	#11	7500
	747L-514H-7-2⑦/BK				2	4	2	4,5	0.7-2	3.6	7	#16	6500
全自動手動線頭包縫 Fully Auto Back Latching Seaming	737L-504M-3-0⑦/BKF				1	3	-	3,4,5	0.7-2	3.6	6	#11	7500
	747L-514M-3-2⑦/BKF				2	4	2	3,4	0.7-2	3.6	5.5	#11	7500
厚毛衣料包縫 Over Seaming On Bulky Knitwear	747L-514H-4-24				2	4	2	4	0.7-2	3.6	7	#16	6500
	747L-514H-4-25				2	4	2	5	0.7-2	3.6	7	#16	6500
牛仔安全縫 Jeans Safety Stitch	757L-516H-3-5⑦				2	5	5	5,6	0.7-2	3.6	7	#16	6000
	757L-516X-3-5⑦※				2	5	5	5,6	0.7-2	3.6	7	#16	6000

700L	布料厚度 Fabric Weight	Fabric Weight			①	⑥	⑦	⑧	⑨	⑩	⑪	⑫	⑬
		L	M	H									
厚毛衣料肩帶包縫 Tape Inserting On Bulky Knitwear	747L-514H-4-24/TG				2	4	2	4	0.7-2	3.6	7	#16	6500
	747L-514H-4-25/TG				2	4	2	5	0.7-2	3.6	7	#16	6500
口袋邊包縫 Pocket Binding	757L-516M-3-35/PS				2	5	3	5	0.7-2	3.6	5	#14	7000
	757L-516M-3-55/PS				2	5	5	5	0.7-2	3.6	5	#14	7000
	757L-401M-8-⑥ 0/TA				2	4	3,5	-	0.7-2	3.6	5	#14	7000
氣動式切刀 Pneumatic type tape/Thread cutter	737L-504M-3-04/ECA(-U)				1	3	-	4	0.7-2	3.6	6	#11	7000
	747L-514M-3-24/ECA(-U)				2	4	2	4	0.7-2	3.6	5.5	#11	7000
	747L-514M-3-24/ECA/BKT				2	4	2	4	0.7-2	3.6	5.5	#11	7000
	747L-514H-3-28/ECA(-U)				2	4	2	8	0.7-2	3.6	4	#11	6500
	747L-514H-4-25/ECA-U				2	4	2	5	0.7-2	3.6	7	#16	6500
	757L-516M-3-⑥ 5/ECA(-U)				2	5	3,5	5	0.7-2	3.6	5.5	#14	7000
	757L-516H-3-55/ECA-U				2	5	5	5	0.7-2	3.6	7	#16	6500
	757L-516X-3-56/ECA-U				2	5	5	6	0.7-2	3.6	7	#16	6000
	767L-644M-3-324/ECA-U				3	6	3+2	4	0.7-2	3.6	5	#11	7000
電動式切刀 Solenoid type tape/ Thread cutter	737L-504M-3-04/ECB(-U)				1	3	-	4	0.7-2	3.6	6	#11	7000
	747L-514M-3-2⑦ /ECB(-U)				2	4	2	3,4	0.7-2	3.6	5.5	#11	7000
	747L-514H-3-28/ECB				2	4	2	8	0.7-2	3.6	4	#11	6500
	747L-514M-3-23/ECB-U				2	4	2	3	0.7-2	3.6	5.5	#11	7000
	747L-514H-4-25/ECB-U				2	4	2	5	0.7-2	3.6	7	#16	6500
	757L-516M-3-⑥ 5/ECB(-U)				2	5	3,5	5	0.7-2	3.6	5.5	#14	7000
	757L-516X-3-56/ECB-U				2	5	5	6	0.7-2	3.6	7	#16	6000
	767L-644M-3-324/ECB(-U)				3	6	3+2	4	0.7-2	3.6	5	#11	7000
	767L-644M-3-524/ECB-U				3	6	5+2	4	0.7-2	3.6	5	#11	7000

700L		布料厚度 Fabric Weight			①	⑥	⑦	⑧	⑨	⑩	⑪	⑫	
		L	M	H									
垂直吸風切線 (附電眼節能裝置) Side Suction Chain-Cutter (With Sensor-Controlled Energy)	737L-504M-3-04/VTE(-U)				1	3	-	4	0.7-2	3.6	6	#11	7000
	737L-504F-2-15/ VTE				1	3	-	1.5	0.7-2	3.6	6	#9	7000
	747L-514M-3-24/ VTE(-U)				2	4	2	4	0.7-2	3.6	5.5	#11	7000
	747L-514H-3-28/ VTE				2	4	2	8	0.7-2	3.6	4	#11	6500
	747L-514M-3-24/ VTA				2	4	2	4	0.7-2	3.6	5.5	#11	7000
水平式吸風切線 (附電眼節能裝置) Flat Suction Chain-Cutter (With Sensor-Controlled Energy-Saving Device)	747L-514M-3-24/ CTE				2	4	2	4	0.7-2	3.6	5.5	#11	7000
	757L-516L-2-24/ CTE				2	5	2	4	0.7-2	3.6	5.5	#14	7000
	757L-516M-3-35/ CTE				2	5	3	5	0.7-2	3.6	5.5	#14	7000
	757L-516M-3-55/ CTE				2	5	5	5	0.7-2	3.6	5.5	#14	7000
	757L-516X-3-56/ CTE ※				2	5	5	6	0.7-2	3.6	7	#16	6000
水平式自動吸風切線裝置 Horizontal Pneumatic Type Chain Cutter (Flat Suction)	767L-644M-3-324/CT				3	6	3+2	4	0.7-2	3.6	5	#11	7000
	767L-644M-3-524/CT				3	6	5+2	4	0.7-2	3.6	5	#11	7000
電動式切布條/鬆緊帶條裝置 Electric Type Tape / Elastic Cutter	747L-514M-3-24/ EC				2	4	2	4	0.7-2	3.6	5.5	#11	6500
上下層防捲邊 Top and bottom anti-curly material	747L-514M-3-24/VT/UC				2	4	2	4	0.7-2	3.6	5.5	#11	7000

※ 搭配厚料修布角刀
With heavy material angle knife.

規格索引，詳細請參考P.31 Specification index, please refer to P.31

- | | | | |
|---------------------|--|-----------------------|--|
| ① 線數 Thread numbers | ④ 車縫布料/上勾針縫容量
Sewing Fabric/Upper Looper capacity | ⑥ 針距 Needle gauge | ⑨ 馬達 Motor
U : U Series
H : H Series |
| ② 機種別 Model | ⑤ 送具型式 Feed dog type | ⑦ 包邊寬度 Overedge width | ⑧ 配件 Device(on) |
| ③ 縫合方式 Sewing types | | | |

700L 直驅系列

700L DD Motor Series

承續 700QD 系列的豐富實戰經驗，SiRUBA 電控技術再提升
Based on the rich experience of 700QD Series, SiRUBA upgrades the control technology.



採用高速伺服馬達

- 以充沛的動力，實現7500 RPM的運轉速度
- 製造精度高，噪音小，發熱低

The high speed servo motor

- By the plenty power, it realizes the operation speed of 7500 RPM.
- High precision makes low noise level and low heat.

採用新型電眼，更靈敏，更精準，偵測無死角

- 體積極小，安裝於車布板下方，單一方向偵測布邊
- 不需調整電眼位置，適用於各種車縫作業情形
- 克服因棉絮阻擋而造成感測失靈的問題

The new sensor is more sensitive, more accurate, no blind spot.

- It is very small, installed under the sewing bed, detecting the fabric by single direction.
- No need to adjust the position, apply to a variety of sewing operations.
- Overcoming the problem of sensory failure due to dust blocking.

控制器模組化設計，以多種組合，全方位滿足各種需求

- 經濟型：節能省電，並可驅動EC切布條裝置
- 多功能型：標配電眼，偵測布料邊緣，以進行自動模式車縫，並可切換半自動或手動模式
- 多功能型分為氣動型與電動型，依客戶的廠房設備，選擇適合的規格

The controller modularized design, with a variety of combinations, comprehensively meets the various demands.

- Economic type: Energy saving, and also drives EC device, electrical tape cutter
- Multi-function type: the sensor checks fabric edge for automatic sewing mode. Also semi-auto or manual mode can be switched on demand.
- Multi-function type includes pneumatic and electrical type. Customers may choose the suitable specification according to the factory facility.

700L 產品組合：配件與直驅電控組

Product Package: Devices and Direct-Drive Control Sets

直驅電控組 Direct-drive Control Set	配件 Device	功能 Function	配件表 Accessory List														
			電眼 Sensor	安全 開關 Safety Switch	操作 面板 Control Panel	手動 開關 Manual Cut Switch	鬆線 Thread Release	切布條 Tape Cutter	吸風切線 Suction Trimmer		LED 照明 LED Light	立式 踏板 Standing Operation Padel	抬壓腳 Auto Foot Lifter	吸風組 Suction Set	針板 Needle Plate		
									側切 Side Cutter	平切 Flat Cutter							
DKLH□-0 經濟型 Economic Type		一般車縫 General Sewing															
	VT	吸風切線 Suction Thread Trimmer									●				●	#4	#3 #4
	CT	吸風切線 Suction Thread Trimmer										●			●	#4	#3 #4
	EC	電動切布條 Electric Type Tape Cutter					●			●					●		

直驅電控組 Direct-drive Control Set	配件 Device	功能 Function	配件表 Accessory List												
			電眼 Sensor	安全 開關 Safety Switch	操作 面板 Control Panel	手動 開關 Manual Cut Switch	鬆線 Thread Release	切布條 Tape Cutter	吸風切線 Suction Trimmer		LED 照明 LED Light	立式 踏板 Standing Operation Padel	抬壓腳 Auto Foot Lifter	吸風組 Suction Set	針板 Needle Plate
									側切 Side Cutter	平切 Flat Cutter					
DKLH□-1 多功能 氣動型 Multi-function Pneumatic Type	ECA	氣動切布條 Air Type Tape Cutter	●	●	●	●		●			●	#2	●	●	標準型 Standard
	VTE	吸風切線 Suction Thread Trimmer	●	●	●		#1	●		●	#2	●	●		
	VTA	吸風切線 Suction Thread Trimmer	●	●	●		#1	●		●	#2	●	●		
	CTE	吸風切線 Suction Thread Trimmer	●	●	●		#1		●	●	#2	●	●		
	UC	上下層防捲邊 Top and Bottom Anti-Curly Edge		●	●				●	●	#2	●	●		
	BKT	簡易型自動包線頭 Simplified Auto Back Latch	●	●	●	●	●	●			●	#2	●	●	
DKLH□-2 多功能電動型 Multi-function Electric Type	ECB	電動切布條 Electric Type Tape Cutter	●	●	●	●		● Solenoid Type			●	#2	● Solenoid Type	●	
DKLU□-0 經濟型 Economic Type		一般車縫 General Sewing								●					
DKLU□-1 多功能型 Multi-function Type	ECA-U	氣動切布條 Air Type Tape Cutter	●	●	●	●		●			●	#2	●	●	加長型 Long type
	ECB-U	電動切布條 Electric Type Tape Cutter	●	●	●	●		●			●	#2	● Solenoid Type	●	
	VTE-U	吸風切線 Suction Thread Trimmer	●	●	●	●	●		●		●	#2	●	●	
	CTE	吸風切線 Suction Thread Trimmer	●	●	●	●				●	●	#2	●	●	

備註 Remark :

● 標準配備 Standard accessory : 吸風組為 700L 電眼型之標準配備 The suction set is standard accessory of 700L sensor type models.

選配 Optional accessory :

#1: BK321-4 | #2: EC467-A | #3: ①TUA-31 需有空壓設備 ②TUD-2 無電刷馬達驅動 | #4: TUA-32K 需有空壓設備

#1: BK321-4 | #2: EC467-A | #3: ①TUA-31 Air compressor is required. ②TUD-2 Driven by Brushless motor. | #4: TUA-32K Air compressor is required.

TUA-3X

三合一吸風集塵組
3-IN-1 SUCTION DEVICE  Device

代號 Code	功能組件 Functional Section			搭配 配件 Collocated Device	適用機型 Applicable Model
	三吸組 3-In-1 Suction Set	氣動抬壓腳 Pneumatic Presser Foot Lifter	機械閥 Mechanical Type Air Switch		
TUA-31	V	V	單聯 Single way	VT CT	700L
TUA-32K			雙聯 Double ways		



規格 SPECIFICATIONS 737L - 504 F - 2 - 0 4 / DKLU

規格索引，詳細請參考P31 Specification index, please refer to P.31

- ① 線數 Thread numbers
- ② 機種別 Model
- ③ 縫合方式 Sewing types
- ④ 車縫布料/上勾針縫容量 Sewing Fabric/Upper Looper capacity
- ⑤ 送具型式 Feed dog type
- ⑥ 針距 Needle gauge
- ⑦ 包邊寬度 Overedge width
- ⑧ 配件 Device(on)
- ⑨ 馬達 Motor
U : U Series
H : H Series

L1 Device								Remark
737L-503M-3-04	1	3	-	4	0.7-2	3.6	6	7500 A
737L-504F-2-04/(⑨)	1	3	-	4	0.7-2	3.6	5	H / U 7500
737L-504M-3-0⑦/(⑨)	1	3	-	4,5	0.7-2	3.6	6	H / U 7500 B
747L-512M-3-25/(⑨)	2	4	2	5	0.7-2	3.6	5.5	H / U 7500 D
747L-512M-3-34/(⑨)	2	4	3	4	0.7-2	3.6	5.5	H / U 7500 D
747L-514M-3-2⑦/(⑨)	2	4	2	3,4,5	0.7-2	3.6	5.5	H / U 7500 C
747L-514H-3-28/(⑨)	2	4	2	8	0.7-2	3.6	4	H / U 6500
757L-516L-2-24/(⑨)	2	5	2	4	0.7-2	3.6	5.5	H / U 7500
757L-516L-2-35/(⑨)	2	5	3	5	0.7-2	3.6	5.5	H / U 7500
757L-516M-3-35/(⑨)	2	5	3	5	0.7-2	3.6	5.5	H / U 7500
757L-516M-3-55/(⑨)	2	5	5	5	0.7-2	3.6	5.5	H / U 7500
767L-644M-3-324/(⑨)	3	6	3+2	4	0.7-2	3.6	5	H / U 7000 E
767L-644M-3-524/(⑨)	3	6	5+2	4	0.7-2	3.6	5	H / U 7000 E

一般包縫

適用於特薄至中厚布料之包縫

Remark

- A: 上勾針為盲勾針
- B: 單排送具
- C: 適用於薄至中厚布料之包縫
- D: 用於薄至中厚布料之一般縫合 (假五線)
- E: 適用於薄至中厚布料之一般縫合，適合小量生產的打樣室或工作室選用，可由勾針及針之變換車縫出5種不同的縫合方式 (504,514,516, 401, 644)

GENERAL SEAMING

For regular seaming on light to medium fabric.

- A: Upper looper is blind looper
- B: Single row feed dog
- C: For regular seaming on light to medium fabric.
- D: Mock 516 seaming
For regular seaming on light to medium fabric.
- E: For regular seaming on light to medium fabric.
Specially suitable for small production workshop, and fashion design studio. A variety of five different sewing types by changing number of needle and looper. (504, 514, 516, 401, 644).



504



514



512



516

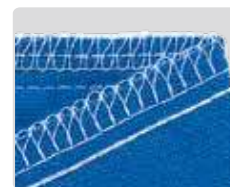

644(401+514)

選購配件
OPTIONAL
DEVICE

VT, TUA

規格 SPECIFICATIONS 737L- 504 F -2-0 2/GAL/ DKLU

規格索引，詳細請參考P.31 Specification index, please refer to P.31

- ① 線數 Thread numbers
- ② 機種別 Model
- ③ 縫合方式 Sewing types
- ④ 車縫布料/上勾針縫容量 Sewing Fabric/Upper Looper capacity
- ⑤ 送具型式 Feed dog type
- ⑥ 針距 Needle gauge
- ⑦ 包邊寬度 Overedge width
- ⑧ 配件 Device(on)
- ⑨ 馬達 Motor
U : U Series
H : H Series

L2 Device

	①	②	③	④	⑤	⑥	⑦	⑧	⑨	S.P.M. (Max)	Remark
737L-504F-2-02/GAL/(⑨)	1	3	-	2	0.7-2	3.6	5	H / U	7500	A	
737L-504F-2-15/(⑨)	1	3	-	1.5	0.7-2	3.6	5	H / U	7500	B	
737L-504M-2-15/(⑨)	1	3	-	1.5	0.7-2	3.6	6	H / U	7500	C	

細包縫 FINE EDGING

Remark

- A. 適用於特薄布料之捲邊細包縫 (荷葉邊) 例如：手帕、禮服等
- B. 適用於特薄布料之捲邊細包縫 (手帕邊包縫) 例如：絲綢類布料之手帕、禮服等
- C. 適用於薄至中厚布料之細包縫 (手帕邊包縫) 例如：手帕、禮服等

A. For fine edging on extra light knit fabric. The presser foot is with fine folding function. (falbala edging)

Eg : Handkerchief & dress...etc.

B. For fine edging on extra light knit fabric. The presser foot is with fine folding function. (handkerchief edging)

Eg : Handkerchief & dress of silk fabric...etc.

C. For fine edging on light to medium fabric. (handkerchief edging)

Eg : Handkerchief & dress ...etc.



737L-504F-2-02/GAL



A

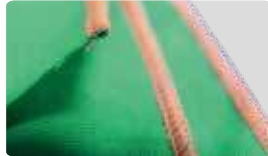

B



C

選購配件 OPTIONAL DEVICE
VT, TUA

L3 Device

	①	②	③	④	⑤	⑥	⑦	⑧	⑨	S.P.M. (Max)
747L-514M-3-2⑦/TG/(⑨)	2	4	2	4.5	0.7-2	3.6	5.5	H / U	7500	

肩帶包縫

適用於針織衣服如T恤、毛衣等之肩部多車一條織帶，可防止衣服肩部變形

TAPE INSERTING

For sewing a woven tape onto the shoulder of knitwear such as T-shirt or sweater etc., to prevent abnormal stretching.



747L-514M-3-24/TG/EC

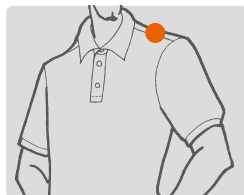

選購配件 OPTIONAL DEVICE
EC, LFA, LS

規格 SPECIFICATIONS 747L-514 M - 8 - 24/ GA / DKLU

規格索引，詳細請參考P.31 Specification index, please refer to P.31

- ① 線數 Thread numbers
- ② 機種別 Model
- ③ 縫合方式 Sewing types
- ④ 車縫布料/上勾針縫容量 Sewing Fabric/Upper Looper capacity
- ⑤ 送具型式 Feed dog type
- ⑥ 針距 Needle gauge
- ⑦ 包邊寬度 Overedge width
- ⑧ 配件 Device(on)
- ⑨ 馬達 Motor
U : U Series
H : H Series

L4 Device

737L-505F-2-04/(⑨)	1	3	-	4	0.7-2	3.6	5	H / U	7500



拷下擺

用於特薄至薄布料之針織T恤·內衣等之下擺或袖口拷縫

BLIND HEMMING

For hemming sleeves and bottoms of T-shirts or underwear etc. Applicable for light to extra light fabric.



特殊效果：上勾針改用LP231盲勾針·可以露出針線

Special effect : replace upper looper by blind looper,LP231, the needle thread can be shown on the surface.

選購配件 OPTIONAL DEVICE
VT , TUA

L5 Device

747L-514M-8-24/GA/(⑨)	2	4	2	4	0.7-2	3.6	5.5	H / U	7000
757L-516M-8-35/GA/(⑨)	2	5	3	5	0.7-2	3.6	5.5	H / U	7000
757L-516M-8-55/GA/(⑨)	2	5	5	5	0.7-2	3.6	5.5	H / U	7000



折景車縫

適中厚布料下層布間歇或連續性不規則折景車縫·可加滾邊喇叭增加車縫品質如裙子·床單·窗簾等

GATHERING

Continuous or intermittent random gathering on lower ply of medium fabric, can be equipped with piping folder to increase sewing quality for shirt, bed sheets, curtains etc.

757L-516M-8-35_GA



GA

選購配件 OPTIONAL DEVICE
EC , FG , VT , CT, TUA

規格 SPECIFICATIONS 737L- 504 M - 3 - 0 4/ LFC-3

規格索引，詳細請參考P.31 Specification index, please refer to P.31

- ① 線數 Thread numbers
- ② 機種別 Model
- ③ 縫合方式 Sewing types
- ④ 車縫布料/上勾針縫容量 Sewing Fabric/Upper Looper capacity
- ⑤ 送具型式 Feed dog type
- ⑥ 針距 Needle gauge
- ⑦ 包邊寬度 Overedge width
- ⑧ 配件 Device(on)
- ⑨ 馬達 Motor
U : U Series
H : H Series

L6 Device

	①	②	③	④	⑤	⑥	⑦	⑧	⑨	S.P.M. (Max)
737L-504M-3-04/LFC-3	1	3	-	4	0.7-2	3.6	6	H / U	4500	
747L-514M-3-2⑦/LFC-3	2	4	2	4.5	0.7-2	3.6	5.5	H / U	4500	
737L-WR/LFC-3	1	3	-	-	-	-	-	H / U	4500	



747L-514M-3-24/LFC-3

鬆緊帶車縫

利用送帶裝置控制鬆緊帶之張力，適用於泳衣，內衣褲或運動服飾之鬆緊帶包縫

LFC-3：機械式送帶

多樣的壓腳可供選擇

電子計數式送帶

SMK:SMK1-A-01 附定位器，適合簡易伺服或離合器馬達

SMK1-A-02 以中繼線，連接伺服馬達

ELASTIC ATTACHING

Tape feeding device controls the tension. Applicable to swimming wear, underwear, sports wear's elastic band attaching.

LFC-3 : Mechanic type elastic tape feeding various presser foots for optional demand.

SMK: Electric metering type elastic tape feeding **SMK1-A-01** with synchronizer for simple servo motor or clutch motor

SMK1-A-02 Connected to servo motor by encoder cable

	737K	747K			
壓具 Presser foot	P216-3	P216-4	P217-4	P218-4	P219-4
鬆緊帶寬度 Band width	2mm~13mm	2mm~13mm	Max. 20mm	Max. 30mm	Max. 35mm
備註 Remark	標配 Standard		選配 Optional		

選購配件 OPTIONAL DEVICE
EC, LFA, LS



737L-WR/LFC-3

管狀布條車縫

將針織布條拷邊車縫後再反條成管形，適用於各種泳裝，睡衣或韻律服等管狀肩帶
注：標準喇叭之布條入布寬度22mm(7/8") 成型之管狀布條直徑為5mm

SPAGHETTI SEWING

To sew knit fabric tape and turn over it into spaghetti tube for swimwears, nightgowns etc...

Remark : Standard folder specification: tape width is 22mm (7/8") and the finished tube size is about 5mm in diameter.

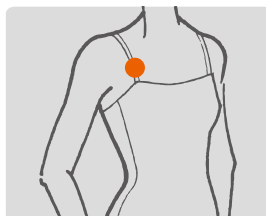

LFC-3

選購配件 OPTIONAL DEVICE
FG

規格

SPECIFICATIONS

737L- 504 M -7- 0 4/ BK/ DKLU

規格索引，詳細請參考P31 Specification index, please refer to P31

- ① 線數 Thread numbers
- ② 機種別 Model
- ③ 縫合方式 Sewing types
- ④ 車縫布料/上勾針縫容量 Sewing Fabric/Upper Looper capacity
- ⑤ 送具型式 Feed dog type
- ⑥ 針距 Needle gauge
- ⑦ 包邊寬度 Overedge width
- ⑧ 配件 Device(on)
- ⑨ 馬達 Motor
U : U Series
H : H Series

L7 Device

		①	②	③	④	⑤	⑥	⑦	⑧	⑨	⑩ S.P.M. (Max)
手動 Manual	737L-504M-7-04/BK/(⑨)	1	3	-	4	0.7-2	3.6	6	H / U	7500	
	747L-514M-7-2⑦/BK/(⑨)	2	4	2	3,4	0.7-2	3.6	5.5	H / U	7500	
	747L-514H-7-2⑦/BK/(⑨)	2	4	2	4,5	0.7-2	3.6	7	H / U	6500	
簡易式全自動 Simplified Fully Auto	747L-514M-3-24/ECA/BKT/⑨	1	3	-	4	0.7-2	3.6	7	H / U	7000	
全自動 Fully Auto	737L-504M-3-0⑦/BKF	1	3	-	3,4,5	0.7-2	3.6	6	H / U	7500	
	747L-514M-3-2⑦/BKF	2	4	2	3,4	0.7-2	3.6	5.5	H / U	7500	



747L-514M-7-24/BK



747L-514M-3-24/ECA/BKT



747L-514M-3-24/BKF



線頭包縫

將線頭包入車縫線內，可防止縫合之開口處縫線脫落，適用於內衣褲、運動服之袖口及側邊縫合

BACK LATCHING SEAMING

To prevent seam looseness, turn over the thread and then insert into overlock seaming at the beginning of sewing. For sleeve and sideways sewing of underwear, sportswear etc.



操作 Operation	配件代號 Code	說明 Description	適用機頭 Applicable Series	驅動方式 Drive Type
手動 Manual	BK	Rotary Plate 	737L 747L	建議搭配伺服馬達· 使用定針功能· 提升車縫效率 To equip with servo motor for needle position function is optional and recommended.
簡易式全自動 Simplified Fully Auto	BKT	1. 簡易式·線頭長度約3cm 2. ECA切刀·針板有特殊風道設計·線頭向下吸回  1. Simplified type, back latch length 3cm. 2. With ECA cutter, Needle plate suction channel for thread-end down turning.	747L	700L電控系統 氣動式 700L : Pneumatic type servo control system
自動 Fully Auto	BKF	1. VT吸風切線 2. 可設定多種操作模式 3. 線頭側向吹回·長度可以調整(最短1cm) 1. With VT suction trimmer 2. Multi-operation mode setting 3. Thread-end side turning. Back latch length is adjustable (Min. 1cm)	737L 747L	BKF專用伺服控制系統 氣動式 BKF : Pneumatic type servo control system

規格

SPECIFICATIONS

737L- 514 H -4- 2 4/ DKLU

規格索引，詳細請參考P.31 Specification index, please refer to P.31

- ① 線數 Thread numbers
- ② 機種別 Model
- ③ 縫合方式 Sewing types
- ④ 車縫布料/上勾針縫容量 Sewing Fabric/Upper Looper capacity
- ⑤ 送具型式 Feed dog type
- ⑥ 針距 Needle gauge
- ⑦ 包邊寬度 Overedge width
- ⑧ 配件 Device(on)
- ⑨ 馬達 Motor
U : U Series
H : H Series

L8 Device

	①	②	③	④	⑤	⑥	⑦	⑧	⑨	S.P.M. (Max)
747L-514H-4-24/ (⑧)/ (⑨)	2	4	2	4	0.7-2	3.6	7	H / U	6500	
747L-514H-4-25/ (⑧)/ (⑨)	2	4	2	5	0.7-2	3.6	7	H / U	6500	
757L-516H-3-5⑦	2	5	5	5,6	0.7-2	3.6	7	H / U	6000	
757L-516X-3-5⑦	2	5	5	5,6	0.7-2	3.6	7	H / U	6000	



747L-514H-4-24/TG/EC



757L-516X-3-56



TG/EC

厚毛衣料肩帶包縫

適用於毛衣之肩部多包縫一條平織布條，可防止衣服肩部變形
注：布條裝置之導板使用，布條最大寬度為1/4"(6.35mm)

TAPE INSERTING ON BULKY KNITWEAR

For sewing a woven tape onto the shoulder of knitwear such as sweater, to prevent abnormal stretching.
Remark : Max. width of tape is 1/4"(6.35mm)

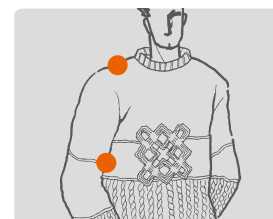

TG/EC 選購配件 OPTIONAL DEVICE

EC, LFA, LS



514H4

厚毛衣料包縫

適用於粗厚毛線衣物車縫

OVER SEAMING ON BULKY KNITWEAR

For regular seaming on bulky knit fabric such as sweater.

514H4 選購配件 OPTIONAL DEVICE

CT, TUA



516X-3

薄牛仔包縫

特殊傳動行程結構適用於薄牛仔布料之包縫，例如：牛仔布 & 工作服

LIGHT DENIM OVERLOCK

Special driving mechanism for seaming on light denim fabric such as jeans, workwears etc.



516X3 選購配件 OPTIONAL DEVICE

CT, TUA

規格

SPECIFICATIONS

757L- 516 M -3- 3 5/ PS / DKLU

規格索引，詳細請參考P.31 Specification index, please refer to P.31

- ① 線數 Thread numbers
- ② 機種別 Model
- ③ 縫合方式 Sewing types
- ④ 車縫布料/上勾針縫容量 Sewing Fabric/Upper Looper capacity
- ⑤ 送具型式 Feed dog type
- ⑥ 針距 Needle gauge
- ⑦ 包邊寬度 Overedge width
- ⑧ 配件 Device(on)
- ⑨ 馬達 Motor
U : U Series
H : H Series

L9 Device



757L-516M-3-35/PS/(⑨)	2	5	3	5	0.7-2	3.6	6	H / U	7000
757L-516M-3-55/PS/(⑨)	2	5	5	5	0.7-2	3.6	6	H / U	7000
757L-401M-8-⑥0/TA/(⑨)	2	4	5	-	0.7-2	3.6	6	H / U	7000



757L-516M-3-35/PS



757L-401M-8-50/TA

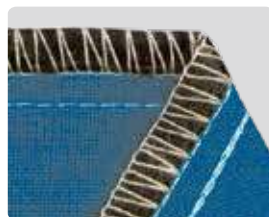

PS



TA

口袋邊包縫

PS : 在褲袋邊緣多上一包邊布條，以強化縫合處，增加美觀
 注：標準喇叭之入布寬度為3/8”(9.5mm)

TA : 雙勾針機型，適用於褲袋邊緣加包邊布條，並車縫兩道環縫線以強化縫合處增加美觀
 注：標準喇叭(入布寬度25.4mm/出布寬度6.4mm)



POCKET BINDING

PS : To insert an extra tape to cover on the edge of pocket then by safety stitching for strengthening the pocket seaming. Suitable for high quality trousers.
 Remark : Standard folder for tape width is 3/8”(9.5mm)

TA : Two needle two chainstitches. Tape binding by two chainstitch on the edge of pocket of high quality trousers.
 Remark : Standard folder (tap width 25.4mm/finish width 6.4mm)



選購配件 OPTIONAL DEVICE

EC . FG

OVERLOCK STITCH

700KST 700KS 700KT

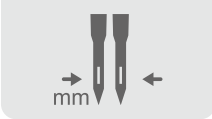
747 KST - 514 M - 3 - 2 - 4 / VT

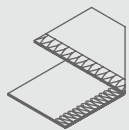
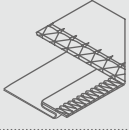
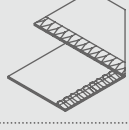
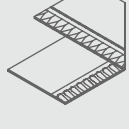
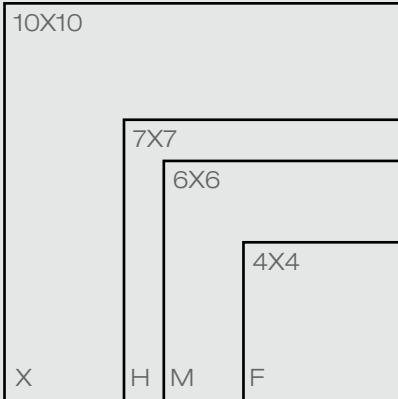
<p>①線數 Thread Numbers</p> <p>737 : 3T 747 : 4T 757 : 5T</p>			<p>⑥針距 Needle Gauge</p> 	<p>⑦包邊寬度 Overedge Width</p> 	<p>⑧配件 Device</p>
<p>②機種別 Model</p> <p>KST 筒型上送 Cylinder-Bed Top-Feed</p> <p>KS 筒型 Cylinder-Bed</p> <p>KT 上送型/安全縫 Top-Feed/Safety Stitch</p>	<p>③縫合方式 Sewing Types</p> <p>504 </p> <p>505 </p> <p>514 </p> <p>516 *For KT </p>	<p>④車縫布料/上勾針縫容量 Sewing Fabric/Upper Looper Capacity</p> <p>F 輕薄布料 Fine Weight Fabric</p> <p>M 中厚布料 Medium Weight Fabric</p> <p>H 厚布料 Heavy Weight Fabric</p> <p>X 特厚布料 *For KT Extra Heavy Weight Fabric</p> 	<p>⑤送具型式 Feed Dog Type</p> <p>2 2排 (標準) 2 Row (Standard)</p> <p>3 3排 (標準) 3 Row (Standard)</p> <p>4 4排 (標準) 4 Row (Standard) *For KT</p>		

OVERLOCK DD SERVO MOTOR

747KST-514M-3-24 / VT / DKK□□

⑨DKK□□ 700KST/700KS/700KT型直驅電控組
Direct-Drive Servo Motor for 700KST/
700KS/700KT
請參閱P.57 Detail on Page.57

700KS/KST series FEATURES

700KS 高速筒型包縫機
High Speed Cylinder Bed Overlock Machine

700KST 高速筒型上送包縫機
High Speed Cylinder Bed Top Feed Overlock Machine

延續700K系列之特點，發展筒型機構延伸成為700KS 系列。再增加
 新型獨立驅動的上送具機構，延伸成為700KST系列

Succeeding 700K Series' features, we develop cylinder bed
 mechanism to extend to 700KS Series. Moreover, with brand new
 independent-drive top feed mechanism, it extends to 700KST Series.

- 筒嘴周長: 148mm · Cylinder Bed Circumference: 148mm
- 縫距調整: 按鈕式 · Stitch Length Adjustment: Push-button
- 差動比調整: 手杆式 · Differential Feed Ratio Adjustment: Lever type
- 潤滑系統: 全自動 · Lubrication: Fully-automatic



① ② ③ ④ ⑤ ⑥ ⑦ ⑧

規格 SPECIFICATIONS 737KS - 505 F - 2 - 0 4 / ESK

規格索引，詳細請參考P.49 Specification index, please refer to P.49

- ① 線數 Thread numbers
- ② 機種別 Model
- ③ 縫合方式 Sewing types
- ④ 車縫布料/上勾針縫容量 Sewing Fabric/Upper Looper capacity
- ⑤ 送具型式 Feed dog type
- ⑥ 針距 Needle gauge
- ⑦ 包邊寬度 Overedge width
- ⑧ 配件 Device(s)
- ⑨ 馬達 Motor
 U : U Series
 H : H Series

700KS Device		①	⑥	⑦	⑧	⑨	⑩	⑪	⑫	⑬	⑭	⑮
		mm	mm	mm	mm	mm	mm	mm	mm	mm	mm	mm
下擺盲縫 Blindstitch Hemming	737KS-505F-2-04	1	3	-	4	0.7~2.0	3.8	5	#9	6500		
	737KS-505F-2-04/ESK											
一般包縫 General Sewing	737KS-504M-3-0⑦	1	3	-	3,4,5	0.7~2.0	3.8	5	#11	6500	VT	
	737KS-504H-3-0⑦	1	3	-	3,4,5	0.7~2.0	3.8	6	#11	6300	LFD6K-□	
	747KS-514M-3-2⑦	2	4	2	3,4,5	0.7~2.0	3.8	5	#11	6500	RLK-□	
	747KS-514H-3-2⑦	2	4	2	3,4,5	0.7~2.0	3.8	6	#11	6300		

700KST Device		①	⑥	⑦	⑧	⑨	⑩	⑪	⑫	⑬	⑭	⑮
		mm	mm	mm	mm	mm	mm	mm	mm	mm	mm	mm
下擺盲縫 Blindstitch Hemming	737KST-505F-2-04	1	3	-	4	0.7~2.0	0.5~6	3.8	5	#9	6300	
一般包縫 General Sewing	737KST-504M-3-0⑦	1	3	-	3,4,5	0.7~2.0	0.5~6	3.8	5	#11	6300	
	737KST-504H-3-0⑦	1	3	-	3,4,5	0.7~2.0	0.5~8	3.8	6	#11	6000	VT
	747KST-514M-3-2⑦	2	4	2	3,4,5	0.7~2.0	0.5~6	3.8	5	#11	6300	RLK-□
	747KST-514H-3-2⑦	2	4	2	3,4,5	0.7~2.0	0.5~8	3.8	6	#11	6000	



ESK 電子盲縫拷下擺裝置
Electric hemming guide

ESSK 電子盲縫拷下擺裝置(附自動升起功能)
Electric hemming guide (with auto-rising function)



盲縫拷下擺之車縫工序中，ESK可防止在過骨時發生脫線問題，配備齊全的直驅馬達，VT吸風切線，TUA集塵組，自動抬壓腳

In blindstitch hemming operation, ESK prevents stitch skipping or ply-shifting at the cross seam sections. The full set includes direct-drive servo motor, VT side suction trimmer, TUA suction set, auto foot lifter.

上圓領系列

CIRCULAR COLLAR ATTACHING SERIES

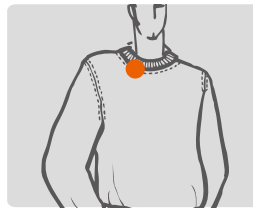

RSK 圓領及褲頭車縫裝置
Circular collar & Waistband attaching device



1. 氣動式導布帶組，左右兩側緊靠圓領布帶，配合滾輪撐開組，使得圓領布帶能夠穩定的前進，車工只需控制大身裁片，提升效率，降低車縫工序的難度
2. 分布裝置透過撥桿感測裝置，可控制布料避免移動走位。
3. 搭配最新直驅節能馬達

*適用圓領、褲頭車縫。

1. Pneumatic tape guide set holds the neckband's right and left side. With tubular extending roller set, the neckband tape can move forward stably so that operators can focus on fabric control, which improves the efficiency and reduces the difficulty of sewing operation.
2. The alignment device makes fabric edge aligned, shift-free during sewing.
3. Equipped with Hohsing direct-drive energy saving motor.

*For circular collar & waistband sewing.

氣動導布與撐開輪組(附自動定位功能)

Pneumatic guide and tubular extending Roller set (with auto-positioning function)



在氣動導布與滾輪撐開的基礎上，加上自動順布條，接縫骨自動定位，減少90%的上料時間

Based on Pneumatic tape guide and tubular extending roller set , with advanced function as Automatic tape alignment, automatic Joint-seam positioning, which reduce 90% material loading time.

- 1 自動偵測縫骨位置，減少工人對位時間
Auto detect the collar seam, by sensor. shorten the rib marking time.
- 2 可調式張力控制機構，減少布料起皺現象
Tubular tension control system avoids puckering.

- 3 導布結構，車縫衣領與布身結合時，防止偏斜
Guiding platform ensures a quality joint of rib and fabrics.
- 4 電眼控制導布機自動開合
Automatically control the fabric feeding.



搭配縫紉機機頭 Machine Head	747KST-514M-3-24VT	領圍車縫範圍 Applicable Collar Circumference	
車縫速度 Sewing Speed	4500 SPM (最高 Max)	領高車縫範圍 Applicable Collar Height	
使用布料 Type of Fabric	彈性布料 Elastic fabric	電源電壓 Power Supply	Single Phase 1Φ AC200~240V 50/60Hz
布厚車縫範圍 Applicable Cloth Thickness	對折後 1.2 mm ±0.2 mm After fold 1.2 mm ±0.2 mm	消費電力 Power Consumption	660 W (Max)
氣體消耗量 Air Consumption	35 公升 / 分 35 L/min	生產效率 Production Capacity	車縫速度：4000 SPM、車縫時間：1 小時 180-240 件 Sewing speed: 4000 SPM、Cycle time: 1 Hr / 180-240 pcs
氣壓 Air Pressure	0.5 MPa		



LFD6K 多功能自動鬆緊帶包縫(700KS 適用) Multi-function computerized automatic elastic attaching (700KS Applicable)

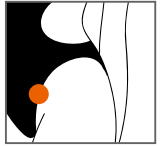

對於鬆緊帶之包縫，可利用電腦控制，進行自動切帶與自動送帶。可設定多段之鬆緊度與車縫長度，適用於泳衣、緊身衣、內褲等小口徑鬆緊帶上帶車縫。

For attaching elastic tape on small openings of swimsuit, leotards or brief, etc. By computer control, with auto cutting and auto tape feeding, elastic tape sewing can be done by multi-section tension and length.

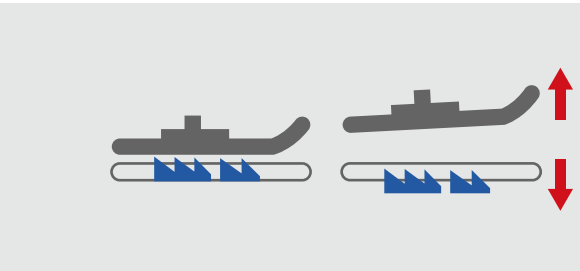

送具下沉功能：壓腳抬起時，送具自動下沉，確保送帶零干擾

Feed dog dropping function : when presser foot lifts, the feed dog drops to ensure tape feeding without obstacle.



直驅伺服馬達：電控功能高度整合，動作配合更精確

Direct drive servo motor : Electrics highly integration realizes the accurate series movements.



送帶 / 切帶功能

- 自動、手動、測試，三種操作模式。自動 / 手動換段，配備LED段數燈號
- 送帶精準，以mm為單位設定送帶長度
- 可調式前送帶，延遲送帶，倒帶功能，前送帶時可追加倒帶之功能
- 送帶速度補償，10組預設值可供選擇
- 因應實際車縫狀況，車縫中可手動強制送帶 / 倒帶。車縫中遇失敗，可自動 / 手動調整至原工程第一段
- 吹氣送帶功能

TAPE FEEDING / CUTTING

- 3 operation modes: Auto, Manual, and Test. Auto/ Manual section changing with LED indicate lamp.
- Precise feeding and the length setting unit is mm.
- Adjustable feeding of forward, delay, reverse, and forward feeding with reverse function.
- Speed compensation with 10 default values for choice.
- For different sewing situations, active feeding may be applied by forward/ reverse when sewing. If sewing operation failed, auto/ manual return to the first section of sewing program.
- Air blow tape feeding function.

設定 / 記憶功能

- 連續縫記憶組數：10組
- 工程段數：18段
- LCD面板顯示設定狀況、操作模式、錯誤代碼
- 觸控面板：圖形介面，設定更容易，添加測試模式，更快上手



SETTING / MEMORY

- Memory of sewing program set: 10 sets
- Program section: 18 sections.
- LCD panel shows setting status, operation mode, and error code.
- Touch panel : Graphical user interface is easy for setting. New added testing mode is easy for beginner.

其他附屬功能

- 鬆線功能
- 吸風切線之省風節能：起始 / 結束吸風時間可以調整 (以針數計算)
- 回踩自動抬壓腳功能

Additional Function

- Thread releasing
- Suction trimmer's energy saving: Starting/ Ending air suction's time is adjustable.(by stitch counting)
- Auto presser foot lifting by paddle step-back.

LFD6K 規格 / SPECIFICATION



連續縫記憶組數 Program set memory	10組 10 sets
每組連續縫工程段數 Sections of every program	18段 18 sections
送帶距離/每針 Tape feeding length per stitch	0.2mm ~ 6.5mm
最高縫速(送距5mm) Max. Speed (stitch length 5mm)	4200 R.P.M
編碼器(定位器) Encoder (synchronizer)	48段脈波 48-pulse
送帶馬達 Tape feeding motor	五相步進馬達 5-phase stepping motor
工作電壓 Voltage	AC 110~220V

選配 / OPTIONAL



▼適用非直驅型
Applicable to non-direct-drive type



內置定位器

Code	Description	Remark
LFD6-A	短滾輪：適用16mm以下之鬆緊帶 Short roller: for tape width 16 mm below	標配 Standard
LFD6-AA	長滾輪：適用16mm~50mm之鬆緊帶 Long roller: for tape width range 16mm~50mm	標配 Standard
LFA	電動式上送帶裝置 Electric tape feeding device Voltage, 110V / 220V	選配 Optional
LF290	抖帶輪 電壓：110V / 220V Euntangling wheel Voltage, 110V / 220V	選配 Optional
VT*	垂直式自動吸風切線 Vertical Pneumatic chain cutter	標配 Standard
TU*	空氣控制閥/集塵裝置 Dust collector suction device	標配 Standard

* 標準配備不列入機型名稱

*Standard devices are not mentioned in model name.



RLK1

筒型撐開輪組

Tubular Extending Roller set

·前後撐開 · 搭配一般桌板
·Diagonal extending roller with closed table top



RLK2

筒型撐開輪組

Tubular Extending Roller set

·前後撐開 · 搭配開口式桌板
·Diagonal extending roller with open table top



RLK3

筒型撐開輪組

Tubular Extending Roller set

·三點式撐開 · 搭配開口式桌板
·Three point extending roller with open table top



RLK3P

筒型撐開輪組(氣動)

Tubular Extending Roller set (pneumatic)

·三點式撐開 · 搭配開口式桌板
·Three point extending roller with open table top
·建議組合 Recommend Package
TUA-38S(ST) / DKH201ADE-A / 700KS-T3-P

700KT SERIES FEATURES



700KT 高速上送包縫機 High Speed Top Feed Overlock Machine

延續700K系列之特點，增加新型獨立驅動的上送具機構，延伸成為700KT系列。

- 縫距調整: 按鈕式
- 差動比調整: 手杆式
- 潤滑系統: 全自動

Succeeding 700K Series' features, we develop brand new independent-drive top feed mechanism, to extend to 700KST Series.

- Stitch Length Adjustment: Push-button
- Differential Feed Ratio Adjustment: Lever type
- Lubrication: Fully-automatic

規格

SPECIFICATIONS

① ② ③ ④ ⑤ ⑥ ⑦ ⑧
737KT - 504 M - 3 - 0 4 / VT

規格索引，詳細請參考P.49 Specification index, please refer to P.49

- ① 線數 Thread numbers
- ② 機種別 Model
- ③ 縫合方式 Sewing types
- ④ 車縫布料/上勾針縫容量 Sewing Fabric/Upper Looper capacity
- ⑤ 送具型式 Feed dog type
- ⑥ 針距 Needle gauge
- ⑦ 包邊寬度 Overedge width
- ⑧ 配件 Device(on)
- ⑨ 馬達 Motor
U : U Series
H : H Series

700KT Device

		①	②	③	④	⑤	⑥	⑦	⑧	⑨	⑩	⑪	⑫
		1	3	-	4,5	0.7~2.0	1~6	3.2	5	#9	7000	VT	
一般包縫 General Sewing	737KT-504M-3-0⑦	1	3	-	4,5	0.7~2.0	1~6	3.2	5	#9	7000	VT	
	747KT-514M-3-2⑦	2	4	2	3,4,5	0.7~2.0	1~6	3.2	5	#11	6700	VT	
折景車縫 Shirring/Gathering	747KT-514H-3-2⑦	2	4	2	3,4,5	0.7~2.0	1~8	3.2	6	#11	6300	VT,GA	
鬆緊帶車縫 Tape Attaching	747KT-514H-4-2⑦	2	4	2	3,4,5	0.7~2.0	1~8	3.2	6	#11	6300	VT	
一般包縫 General Sewing	757KT-516M-3-3⑦	2	5	3	4,5	0.7~2.0	1~6	3.2	6	#14	6700	CT	
	757KT-516M-3-5⑦	2	5	5	5,6	0.7~2.0	1~6	3.2	6	#14	6700	CT	
鬆緊帶車縫 Tape Attaching	757KT-516H-3-5⑦	2	5	5	5,6	0.7~2.0	1~7	3.2	7	#21	6300	CT,GA	
特厚布 Extra Heavy	757KT-516X-3-5⑦※	2	5	5	6,7	0.7~2.0	1~7	3.2	8	#21	5500	CT	

※ 搭配厚料修布角刀
With heavy material angle knife.

DEVICE



BK

包線頭裝置 Back Latching

將線頭一起包入車縫，可防止縫合開口處(如袖口)之縫線脫落

- KD207手輪: 訂機頭有裝此零件以配合定針用，若個別訂購BK組則依需要訂購
- 包含BK232車布導板

To prevent seam looseness, turn over the thread and then insert into overlock seaming at the beginning of sewing.

- KD207 hand wheel: standard equipment of 700K/BK machine, optional for BK device.
- Including BK232 sewing bed .

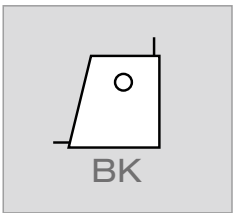

可自行組裝 self-installation : YES

適用機型 applicable model : 737L-504M-7, 747L-514M-7, 747L-514H-7



BKT

簡易式自動包線頭 Simply Auto Back Latch

為ECA延伸功能，車縫效率極高，針板有特殊風道設計，線頭在切線後，瞬間吸回，線頭長度約3cm。

It is an ECA extending function. The sewing efficiency is very high. Special needle plate suction channel is for thread-end down turning. It pulls back the chain while a wink. The back latch length is about 3cm.

可自行組裝 self-installation : NO

適用機型 applicable model : 747L-514M-3-24/ECA/BKT



CT

水平式自動吸風切線裝置 Horizontal Pneumatic Type Chain Cutter (Flat Suction)

利用吸風式馬達或空壓機，將線吸入切刀槽中予以切斷(較適用於4~6線之機型)

Take thread into trimmer tube by suction motor or air compressor.
(Applicable for 4~6 thread machine)

可自行組裝 self-installation : YES

適用機型 applicable model : 767L



CTE

水平式吸風切線 (附電眼節能裝置) Flat Suction Chain-Cutter (With Sensor-Controlled Energy-Saving Device)

以電眼偵測布邊，控制吸風功能在切線時運作，減少空壓設備的能源消耗，並避免縫線浪費。

1. 垂直式吸風切線適合內褲廠等輕薄及不規則的針織面料車縫，提升效率。
2. 切刀之吸風口的設計使得切線更加快速。
3. 針對網紗、強反光絲光棉等特殊面料，採用專業的電控程式控制，均能輕鬆車縫及完成切線，不會造成切刀誤切。
4. 「切線後自動停車功能」以及「無面料即不車縫功能」可減少縫線的浪費。
5. VTA以氣缸推動切刀，減少刀刃磨耗，大幅延長使用壽命。

Electric eye (sensor) checks the fabric edge. It saves the energy consuming of air compressor system and also saves thread consuming.

1. Vertical suction trimming is suitable for sewing the light fabric like under-wear or irregular knitwear, to improve the efficiency.
2. The design of the suction inlet of the trimmer makes the trimming faster.
3. For those special fabrics such as mesh fabric, mercerized cotton etc, the stitches are easily accomplished as well as the trimming by the professional computer controlled without mistake-trimming.
4. Functions with auto stop sewing after trimming and with no fabric can save the stitches.
5. VTA trimmer is controlled by air cylinder, which reduces the blade stroke times and extends the durability.

可自行組裝 self-installation : NO

適用機型 applicable model : 747L, 757L



DKL 12 DKK 12

直驅伺服馬達 Direct-drive Servo Motor

包縫機模組化搭配直驅伺服馬達，多樣化的選擇，更有彈性

1= 廠商代碼 2= 版本代碼 + 功能代碼

Overlock machine equipped with the modularized direct-drive servo motors to be more flexible for diversification.

1=Manufacturer code 2=Version code + Function code

可自行組裝 self-installation : YES

適用機型 applicable model : 全系列包縫機 All Overlock Series



EC

電動式切布條/鬆緊帶條裝置 Electric Type Tape / Elastic Cutter

利用手動按鈕方式切斷鬆緊帶，不織布條或滾邊布條

1. 分標準切刀EC-K (16 mm) · 長切刀EC-K-A (22 mm)
2. 標準為手動切帶，另可選購膝控切帶(FEC34-A)

Cuts tape/ elastic by pressing the button.

1. EC-K: Standard knife (16 mm") EC-K-A: Long knife (22 mm")
2. Hand-control button : standard Knee-control paddle (FEC34-A) : Optional

可自行組裝 self-installation : YES

適用機型 applicable model : MODEL w/GA/P, MODEL w/LFC-3, MDDEL w/PS, MODEL w/TA, MODEL w/TG



ECA
ECB

**氣動式切刀 (自動模式切換功能/附手動)
Pneumatic Type Tape / Thread Cutter (With Auto / Manual Switch Function)**

**電動式切刀 (自動模式切換功能/附手動)
Solenoid Type Tape / Thread Cutter (With Auto / Manual Switch Function)**

採用新一代的電眼，性能再升級。ECA為氣動式，ECB為電動式，搭配吸風線槽，操作更順暢。

- 1.手動、半自動及全自動操作模式，附轉換按鍵，且可透過操作面板調整。
- 2.防誤切保護裝置:切刀旁安裝一電眼，如有被遮擋的狀況下，切刀不會動作，能有效地防止切刀誤切到布料。
- 3.手動切線補償按鍵，如因操作問題沒有切斷線，可透由此按鍵進行手動切線。
- 4.手動模式下，可後踩踏板切線。
- 5.針對網紗、強反光絲光棉等特殊面料，採用專業的電控程式控制，均能輕鬆車縫及完成切線，不會造成切刀誤切。

Brand new sensor upgrades the performance. ECA is pneumatic type, and ECB is electric type, compatible with air suction slot, which makes the operation more smoothly.

1. Manual, semi-auto and fully-auto operation mode, attached the switch keys, and could be adjusted by the panel.
2. Mistake-proof protection device: One sensor equipped near the trimmer. If the sensor is blocked, the trimmer is deactivated effectively for avoiding from cutting the fabric.
3. Manual trimming compensation stitch key: If the thread is not cut due to the operation, it can be done by the key.
4. Under the manual mode, it could be fully backward pedaled to cut the thread.
5. For those special fabrics such as mesh fabric, mercerized cotton etc, the stitches are easily accomplished as well as the trimming by the professional computer controlled without mistake-trimming.



ECA



ECB



	三電眼 Three sensors	切刀 Cutter	抬壓脚 Foot Lifter	氣動配件Pneumatic Set	
				吸風集塵組 Suction Set	吸風線槽 Suction Channel
ECA / ECA-U	√	氣動 Pneumatic	氣動 Pneumatic	√	√
ECB / ECB-U	√	電動 Electric	電動 Electric	√	√

可自行組裝 self-installation : NO

適用機型 applicable model : 737L, 747L 757L, 767L, 737LQ,747LQ, 757LQ



FG

側帶盤 Side Tape Holder

置於桌板右側放布條用

For tape feeding, on the right side of the table.

可自行組裝 self-installation : YES

適用機型 applicable model : MODEL w/GA/P, MDDEL w/PS, MODEL w/TA



GA

折景裝置 Gathering

下層布間歇或連續性不規則折景

P滾邊器(喇叭)KV57(入布寬度25mm/出布寬度6mm)依需要可另訂·若滾邊加繩需另訂壓具(壓具底需磨一條溝)·為一般壓具代號多加P·如:P204P

Continuous or intermittent random gathering on lower ply.

P: Piping folder KV57 (tape width 25mm / finish width 6mm) is optional. For piping with rope inside, presser foot requires a trench, which is marked with P at the end of parts code. eg P204P.

可自行組裝 self-installation : YES

適用機型 applicable model : 747KT-514H, 747L-514M-8, 747L-516M-8



GAL

荷葉邊密拷裝置 Flounce/Falbala fine edging

彈性布料密合時·以壓布杆向下壓住布料邊緣·形成向後拉力·而產生荷葉邊造型·可調整壓力產生不同的波浪效果

Elastic fabric fine serging with a pull-back device makes flounce/ falbala style.

Adjust the pressure of pull-back plate to have big or small waves.



可自行組裝 self-installation : YES

適用機型 applicable model : 737L-504F-2



KB301

簡易防捲邊裝置 Simple anti curly selvedge device

安裝容易·透過裝置有效輔助捲曲布料工段之車縫。

Easy to install, effectively solve curly selvedge problem.

可自行組裝 self-installation : YES

適用機型 applicable model : MODEL 700L, MODEL 700LQ, MODEL 700KT

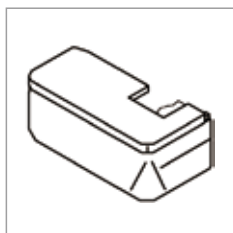

KB561-A

平台式車布導板 Flat Bed Cloth Plate

將筒型車改為平台式·方便於非筒型衣物包縫

To convert cylinder bed machine into flat bed machine. For normal overlock sewing operation.

可自行組裝 self-installation : YES

適用機型 applicable model : 700KS



FA

側向電動送帶裝置 Side Electric Tape Feeding

1. 利用電子微動開關控制布條·鬆緊帶或蕾絲之輸送長度·使上帶車縫更加平順
2. 送帶在控制箱右邊

1. With electronic switch to control the feeding length of tape, elastic, or lace to create smoother sewing.

2. Tape feeding will be on the right hand side of the control box.

可自行組裝 self-installation : YES

適用機型 applicable model : 700L



LFA

電動式直向送帶裝置 Electric Type Upper Tape Feeding Device

利用電子馬達帶動鬆緊帶，使其放鬆到零鬆緊狀況，並可控制所需鬆緊帶之長短，使車縫時鬆緊度能一致

電壓：110V / 220V

To keep constant tension for sewing. Elastic tape is fed by motor for zero tension and required length.

Voltage, 110V / 220V

可自行組裝 self-installation : YES

適用機型 applicable model : MODEL w/LFC-3, MODEL w/TG



LF290

抖帶輪 Untangling Wheel

可選配安裝於LFA (送帶裝置)，以逆轉的方式，抖動鬆緊帶，做為送帶前的處理

電壓：110V / 220V

An optional device to be equipped with LFA (tape feeding device). Untangling the elastic tape by reverse rotation wheel is a pre-feeding process.

Voltage, 110V / 220V

可自行組裝 self-installation : YES

適用機型 applicable model : MODEL w/LFA



LFC-3

機械式鬆緊帶送帶裝置 Mechanical Type Elastic Feeding

利用齒輪調整控制鬆緊帶之鬆緊程度；壓具:分3線及4線用如：P216-3·P216-4 (標準品配P216除非下單時註明)

To Control elastic tape tension by adjusting the gear.

Presser foot:

P216-3 for 3 thread

P216-4 for 4 thread

Standard is P216. Special demand by request.

壓具代號 Presser Foot	P216	P217	P218	P219
鬆緊帶尺寸 Elastic Size	2-13mm	2-20mm	2-30mm	2-35mm

可自行組裝 self-installation : YES

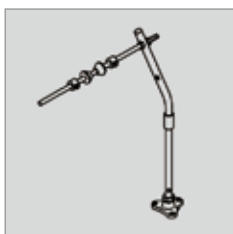

LS

上方帶盤 Upper Tape Holder

置於上前方放布條或鬆緊帶

For top feeding tape or elastic.

可自行組裝 self-installation : YES

適用機型 applicable model : MODEL w/LFC-3, MODEL w/TG



PS

口袋包邊縫合裝置 Pocket Sewing

在褲袋邊緣多車上一包邊布條，以強化縫合處增加美觀

喇叭PS201:可用布條寬度為3/8" (9.5mm)

Overlock sewing with tape binding for strengthening the pocket edge.

PS201: Folder, for tape width 3/8" (9.5mm)

可自行組裝 self-installation : YES

適用機型 applicable model : 757L-516M-3



UC

UC-L

上下層防捲邊 Top and Bottom Anti-Curly Edge

針對易捲曲布料所開發的氣動裝置，在布料進入壓腳之前，將布料吹平，可適用內捲、外捲等各種捲曲的情形，大幅增加車縫效率

有三種版本可選搭：UC-L(高級電控式)、UC-L2(經濟機械式)、UC-L3(外捲單一式)

The pneumatic device solves the problem of curly edge material. The fabric edge is flattened by air before entering the presser foot. Applicable to up-roll, down-roll, and all kinds of curly edge situations, which highly improves the sewing efficiency.

There are 3 types for this device. UC-L (High-end electronic control type), UC-L2 (economic mechanical type), and UC-L3 (Up-roll only type).



UC-L2

可自行組裝 self-installation : YES
適用機型 applicable model : 700L Series

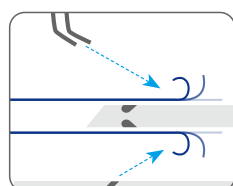

▲外捲模式 Up-roll :
UC-L2/UC-L3 Mechanical & Automatic-Type

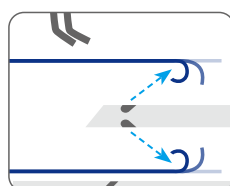

▲內捲模式 Down-roll :
UC-L2 Mechanical & Automatic-Type

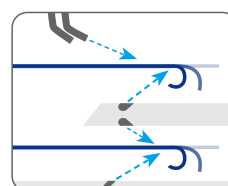

▲內外捲模式 Up-roll and Down-roll :
UC Automatic-Type



TA

雙勾針環縫口袋包邊縫合裝置 Two Chainstitch Pocket Sewing

在褲袋邊加包邊布條並車兩道環縫線，以強化縫合處增加美觀，標準喇叭(入布寬度 25.4mm/出布寬度6.4mm)

Tape binding by two chainstitch sewing for strengthening the pocket edge.
Standard folder(tape width 25.4mm/ finish width 6.4mm)

可自行組裝 self-installation : YES
適用機型 applicable model : 757L-401M-8-30, 757L-401M-8-50



TBK

全沉式機頭安裝支撐組 Machine Body Supporter for Full Submerged Table

全沉式桌板機頭支撐組

700K series machine base for full submerged table.

可自行組裝 self-installation : YES
適用桌板 applicable model : Table 700K-T2



TG

車肩帶裝置 Tape Guide

在車針織布時多車上一條平織布條，可防止肩部寬變型張開，壓具P254J-4A布條最大寬度為13mm

To prevent knit wear shoulder stretching, insert woven tape for strengthening.
P254J-4A: Presser foot for maximum tape width is 13 mm.

可自行組裝 self-installation : YES
適用機型 applicable model : 747L-514M-3, 747L-514H-4



VT

垂直吸風式自動切線裝置 Vertical Pneumatic Type Chain Cutter (Side Suction)

利用吸風馬達或空壓機將線吸入切刀槽中予以切斷(較適用於3~4線之機型)

Take thread into trimmer tube by suction motor or air compressor. (Applicable for 3-4 thread machine)

可自行組裝 self-installation : YES

適用機型 applicable model : 737L, 747L, 737KS, 747KS



VTE

垂直吸風切線 (附電眼節能裝置)

Side Suction Chain-Cutter (With Sensor-Controlled Energy)

電控系統支持電眼節能裝置，採用電眼偵測布邊，利用控制箱調整旋鈕，控制吸風功能在切線時運作，減少空壓設備的能源消耗，並避免縫線浪費

Our computerized system drives sensor-controlled energy saving device. Electric eye (sensor) checks the fabric edge. Turn the button of control box to set the time of air suction of chain-cutter. It saves the energy consuming of air compressor system and also saves thread consuming.

可自行組裝 self-installation : NO

適用機型 applicable model : 737L, 747L



**WR/
LFC-3**

管狀布條車縫裝置(反條裝置) Spaghetti Sewing

針織布條之拷邊車縫並反條成管形，適用於各種泳衣或睡衣、韻律服等之管形肩帶，喇叭布條寬度約22.2mm (7/8")，成型肩帶直徑5mm

Overlock sewing at knit tape edge and then turn it into tube. For swimwears, night gowns etc. Folder size: tape width is 22.2mm, finished tube size is 5mm in diameter.

可自行組裝 self-installation : YES

適用機型 applicable model : 737L, 747L

TUA-3X

三合一吸風集塵組 / 3-in-1 Dust Collecting Suction Device

電眼機型(ECA, ECB, CTE, VTE)標準配備的吸風集塵組，可適用於700L、700KT/ KS/KST系列，線屑(後吸風)、布屑(前吸風)、棉絮(內吸風)同時清除

Standard device of sensor-controlled machine (ECA, ECB, CTE, VTE), which cleans away thread ends (rear suction), cloth waste (front suction), and lint (inner suction). Compatible to 700L, 700KT/KS/KST.

代號 Code	功能組件 Functional Section						適用機型 Applicable Series	備註 Remark	
	吸布屑方式 Vacuuming Way			抬壓腳 Presser Foot Lifter	氣閥 Air Switch				濾瓶 Filter
	前吸 Front	後吸 Back	切刀處 Trimmer		機械式 Mechanical Type	電磁閥式* Solenoid Type			
TUA-31					單聯 Single way		●	700K / L KS / KST / KT	700K/ Q 腳踏連桿共用 The treadle rod of 700K/ Q is shared.
TUA-31-A									
TUA-32K				●	雙聯 Double ways			700K	
TUA-33K	●	●	●			單聯 Single way	●		電控型號：HD-40-2-7K
TUA-34K	●	●	●	●		雙聯 Double ways	●		電控型號：HD-40-2-7K
TUA-32KT				●	雙聯 Double ways			700KT	
TUA-34KT				●		雙聯 Double ways	●		電控型號：HD-40-2-7K
TUA-36	不零售，700LD專用CTE,ECA,ECB,VTE,VTA (搭配電眼節能省風裝置) No retail, exclusive CTE, ECA, ECB, VTE, VTA for 700LD (Allocated with the electronic eye, power-and-wind-saved device)								
TUA-37S						單聯 Single way	●	700KS / KST	電控型號： GD-40-4-7K-220
TUA-38S	●	●		●		雙聯 Double ways	●		電控型號： GD-40-4-7K-220 *僅適用700KS *only for 700KS
TUA-39S					單聯 Single way				
TUA-40S				●	雙聯 Double ways				*僅適用700KS *only for 700KS
TUA-38ST	●	●		●		雙聯 Double ways	●	700KST	電控型號： GD-40-4-7K-220 *僅適用700KST *only for 700KST
TUA-40ST				●	雙聯 Double ways				*僅適用700KST *only for 700KST
TUA-41S				●		雙聯 Double ways	●	700KS / ESK	電控型號： i60-4-ES *僅適用700KS/ESK 接頭規格 *only applicable to 700KS/ESK adapter spec
TUA-41ST	●	●		●			●	700KS / RSK	電控型號： i60S-4-RS *僅適用700KS/RSK 接頭規格 *only for 700KST *包含電眼控制過骨機構彈開功能 *with sensor-controlled flick function for cross seam mechanism
TUC-01			●	●		三聯 Trigeminy		700K / L	For ECA-U 機型用
TUC-02	●	●				單聯 Single way	●		For ECB-U 機型用
TUC-03				●		三聯 Trigeminy			For VTE-U 機型用

*TUA-37S、TUA38S、TUA39S、TUA40S、TUA-38ST、TUA40ST、TUA41S、TUA41ST 需搭配開口型桌板(64頁) Open type table required (Page.64)

* 備註：電磁閥需由伺服馬達的電控箱驅動，接頭規格15-Pin(賀欣i系列)。TSA或簡易直驅系列不支援

* Remark: The solenoid must be driven by full function servo motor. The adapter spec is 15-Pin (Hohsing iseries). TSA Series and Simple type direct-drive servo motor are not applicable.

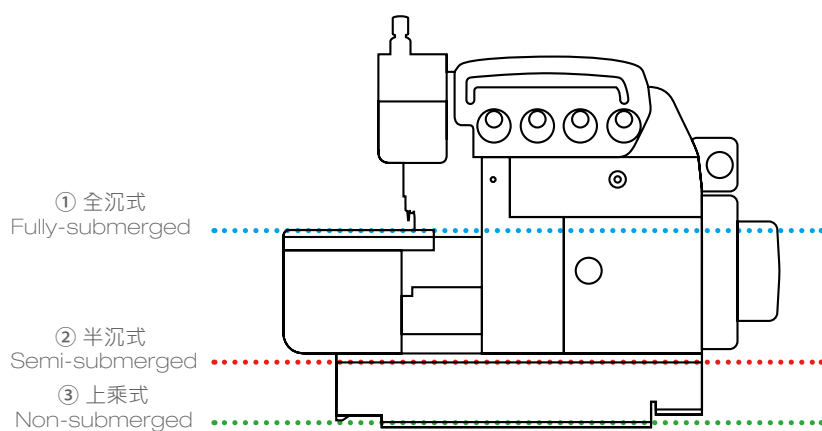

TABLE

桌板代號 Item No.	尺寸 / Size (mm)			說明 Description	適用機型 Applicable Model	備註 Remark
	長 Length	寬 Width	厚 Thickness			
700K-T	1200	540	40	② 半沉式 Semi-submerged	700L, 700KT 一般車 700L, 700KT Standard Model	
700K-T2	1200	540	40	① 全沉式 Fully-submerged	700L 一般車 700L Standard Model	需搭配 TB201 TB201 set required
700K-T3	1200	540	40	① 全沉式 Fully-submerged	700L/EC, CT, VT	需搭配 TB201 TB201 set required
700K-T4	1200	540	40	② 半沉式 Semi-submerged	700L/BKF	
700LD-T	1200	540	40	② 半沉式 Semi-submerged	700KT, 700L 直驅車 700KT, 700L DD Motor Model	
700LD-T1	1200	540	40	② 半沉式 Semi-submerged	700LD/UC,SD	
700KS-T	1200	540	40	② 半沉式 Semi-submerged	700KS, 700KST	
700KS-T2	1200	540	40	② 半沉式 Semi-submerged	700KS, 700KST 直驅車 700KS, 700KST DD Motor Model	
700KS-T1	1200	540	40	② 半沉式 Semi-submerged	700KS, 700KST	開口型 Open type
700KS-T3	1200	540	40	② 半沉式 Semi-submerged	700KS, 700KST 直驅車 700KS, 700KST DD Motor Model	開口型 Open type
700KS-T4	1200	540	40	② 半沉式 Semi-submerged	700KS, 700KST	開口型搭 KX10E-A布漏組 Open type with KX10E-A cloth slide
700KS-T5	1200	590	40	③ 上乘式 Non-submerged	700KS/LFD	開口型 · 搭SM899-A Open type with SM899-A

INTERLOCK STITCH

High speed interlock stitch machine

C007 L - W 12 2 - 3 56 / CQ

②系列 Series

L	高速型 Ultra High Speed
LX	微油型 Semi-Dry
KP	K型進階款 K Plus
K	基本款 Basic Type
KD	基本款配直驅馬達 K Type with DD Motor

④功能 Function

12	一般平縫 General Plain Seaming
13	拷下擺 Bottom Hemming
15	羅紋褲頭鬆緊帶包縫 Tubular Rib-Fabric Elastic Waistband Attaching
16	一般厚布料之平縫 General Plain Seaming for Heavy Material
22	滾邊車縫 Tape Binding
32	拷克骨車縫 Overlock-Seam Covering
51	鬆緊帶上帶車縫 Elastic Tape Attaching
52	鬆緊帶附右切刀 Elastic Tape Attaching with Right Side Fabric Trimmer
53	環型鬆緊帶車縫 Tubular Elastic Waistband Attaching
54	鬆緊帶折縫 Elastic Hemming
61	褲耳車縫 Belt Loop Seaming
71	雙勾針結構 Double-Looper Mechanism
72	三勾針結構 Triple-Looper Mechanism
81	左切刀修布裝置 Left Side Fabric Trimming
82	鬆緊帶上帶邊縫附左切刀 Elastic Tape Insertion with Left Side Fabric Trimmer
92	四針六線搭接縫 Four-Needle Flat Seaming

⑥針數
Needle Numbers

Needle Numbers

⑧配件
Device

Device

⑦	No.	mm	inch
	32	3.2	1/8
	40	4.0	5/32
	48	4.8	3/16
	56	5.6	7/32
	64	6.4	1/4

⑤針板舌片
Needle Plate Finger

Needle Plate Finger

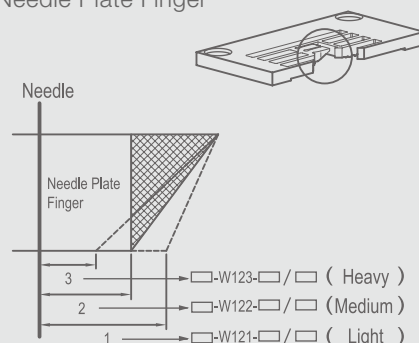

- 1 = 薄布料/細結線(密針)
Light Material/Short Stitch Length
- 2 = 中厚布料/中結線(一般針)
Medium Material/Common Stitch Length
- 3 = 厚布料/粗結線(粗針)
Heavy Material/Long Stitch Length

①機種別 Model

C	筒型 Cylinder Bed
F	平台型 Flat Bed
S	小筒型 Small Cylinder Bed
U	超小筒 Ultra Small Cylinder Bed

③網線方式 Covering Types

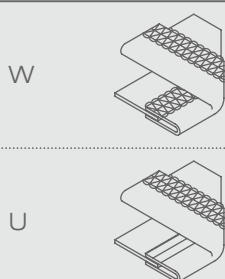

- ⑨DCL □□ C007L/LX型直驅電控組
Direct-Drive Servo Motor for C007L/LX
- ⑨DCK □□ C007KP型直驅電控組
Direct-Drive Servo Motor for C007KP
- ⑨DFK □□ F007KD型直驅電控組
Direct-Drive Servo Motor for F007KD
- ⑨DSK □□ S007KD型直驅電控組
Direct-Drive Servo Motor for S007KD
- ⑨DUK □□ U007型直驅電控組
Direct-Drive Servo Motor for U007

INTERLOCK DD SERVO MOTOR

C007KP-W162-364 / CH / DCK□□

*馬達介紹，詳細請參考P.114
Direct-direct, please refer to P.114

登峰

Ascend to Greatness

造極

C007LX



C007L SERIES

C007L

超高速型繙縫機

Ultra High Speed Cylinder Bed
Interlock Stitch Machine

C007LX

微油超高速型繙縫機

Semi-Dry Ultra High Speed Cylinder
Bed Interlock Stitch Machine

C007L/LX SERIES FEATURES

結合SiRUBA最高端技術的旗艦機種

Flagship model with SiRUBA's state-of-the-art innovation.



內縮式床台

縫製物更靠近針孔，車縫定位精準，車縫時更加順暢就手

The Recessed Machine Bed

With the recessed machine bed, sewing material comes closer to the needle hole, thus provides more precise easier, and smoother sewing.



短筒座的設計

操作性能優越，可因應廣泛的飾蓋縫紉工程，增加延伸蓋就可以車縫邊或包帶之縫紉工程

Recessed Cylinder Bed

The recessed cylinder bed on the front cover is shortened. The short cylinder has superior operating performance, which can be applied to the extensive covering seam. Hemming or wrapping can be sewed just by increasing the extended cover.



針棒與勾針的新油封結構

新的油封設計強化了機構的油附著力，減少了潤滑油甩出。同時使用高耐磨材料，顯著提高性能及替代

New Oil Sealing Technology

New oil sealing structure used on needle bar and looper mechanism can efficiently avoid oil splash. New wear-resistant material also enhances performance and durability.

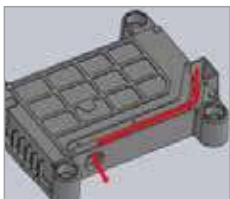

新型散熱結構同時降低震動

全新散熱設計提供最佳降溫效率。更穩固的防震結構，提升機械的安定與精度，車縫體驗更為順暢

New Cool Down Technology

Frame structure renewed with better cooling mechanism. Vibration is also reduced to contribute better sewing experience.

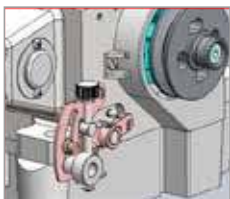

直感式的差動送具調整

差動送具的調整機構設計在縫紉機本體的右後方，於車縫時使用右手直感操作，精準無誤

Easy-to-adjust Differential Feed Dog Design

The differential feed dog adjuster is placed at right side of the operator. Adjust it easily without hesitation.



新設計上夾線裝置
出刀迅速精準·夾線穩定

Brand New Design Upper Thread Gripper

The newly designed upper thread gripper provides fast, precise movement and stable thread gripper.



雙天秤挑線控線組

全新雙天秤挑線控線組的設計·縫製厚、薄布料皆適用·車縫適用範圍更廣·適用性更高

Dual Thread Take-up Mechanism

The brand new design of dual thread take-up lever thread tension combination is ideal for both heavy and light fabric. Sewing applicable range is wider and the applicability is higher.

- 中厚布料 (Medium heavy fabric)
- 薄布料 (Light fabric)



C007LX series

無油無慮 Oilless is trouble-free.

SiRUBA 的三針車提供您暢快的縫製體驗

C007LX provides you all new sewing experience.



針棒採用特殊的表面處理·縫製時無油污油漬·顯著提高縫製品質·減少重工與縫製品髒污垢·針棒潤滑機構同時再進化·增加零件耐久度

Needle bar mechanism re-designed with new surface treatment, no oil stains and oil splash during operating, greatly increase sewing quality. Needle bar also has better durability due to new lubrication mechanism.

規格
SPECIFICATIONS
C007LX - W122 - 240 /CH/DCLU

規格索引，詳細請參考P.65 Specification index, please refer to P.65

- | | | | |
|-----------------------|----------------------------|-------------------|--------------|
| ① 機種別 Mode | ④ 功能 Function | ⑦ 針距 Needle gauge | ⑨ 馬達 Motor |
| ② 系列 Series | ⑤ 針板舌片 Needle Plate Finger | ⑧ 配件 Device | U : U Series |
| ③ 網線方式 Covering Types | ⑥ 針數 Needle Numbers | | H : H Series |

C007L/C007LX Device										
一般平縫 / 下擺車縫 General Seaming/ Bottom Hemming	C007L-W12 ⑤ -2 ⑦ /CH	1,2	2	4	3.2/ 4.0/ 4.8	1.4-3.6	0.9~1.4	5/7	H / U	6000
	C007L-W12 ⑤ -3 ⑦ /CH	1,2	3	5	4.8/ 5.6/ 6.4	1.4-3.6	0.9~1.4	5/7	H / U	6000
	C007L-U12 ⑤ -2 ⑦ /CH	1,2	2	3	3.2/ 4.0/ 4.8	1.4-3.6	0.9~1.4	5/7	H / U	6000
	C007L-U12 ⑤ -3 ⑦ /CH	1,2	3	4	4.8/ 5.6/ 6.4	1.4-3.6	0.9~1.4	5/7	H / U	6000
	C007L-W12 ⑤ -2 ⑦ /RH/RCH-3M	1,2	2	4	4.0/ 4.8	1.4-3.6	0.9~1.4	5/7	H / U	6000
	C007L-W12 ⑤ -3 ⑦ /RH/RCH-3M	1,2	3	5	5.6/ 6.4	1.4-3.6	0.9~1.4	5/7	H / U	6000
	C007L-U12 ⑤ -2 ⑦ /RH/RCH-3M	1,2	2	3	4.0/ 4.8	1.4-3.6	0.9~1.4	5/7	H / U	6000
	C007L-U12 ⑤ -3 ⑦ /RH/RCH-3M	1,2	3	4	5.6/ 6.4	1.4-3.6	0.9~1.4	5/7	H / U	6000
	C007L-W162-2 ⑦ /CH	2	2	4	4.0/ 4.8	1.4-3.6	0.9~1.4	5/7	H / U	6000
	C007L-W162-3 ⑦ /CH	2	3	5	5.6/ 6.4	1.4-3.6	0.9~1.4	5/7	H / U	6000
選購配件 : UTP, UTQ, UTR, UTS, CLA, CMR, CAR/UTP, CAR/UTQ Optional Device: UTP, UTQ, UTR, UTS, CLA, CMR, CAR/UTP, CAR/UTQ										
拷克倒骨蓋縫 Overlock-seam Covering Stitch	C007L-W322-3 ⑦ /CC	2	3	5	5.6/ 6.4	1.4-3.6	0.9~1.4	5/7	H / U	6000
	C007L-U322-3 ⑦ /CC	2	3	4	5.6/ 6.4	1.4-3.6	0.9~1.4	5/7	H / U	6000
	C007L-W322-3 ⑦ /CE	2	3	5	5.6/ 6.4	1.4-3.6	0.9~1.4	5/7	H / U	6000
	C007L-U322-3 ⑦ /CE	2	3	4	5.6/ 6.4	1.4-3.6	0.9~1.4	5/7	H / U	6000
選購配件 : UTP, UTQ, UTR, UTS, CLA, CMR, CAR/UTP, CAR/UTQ Optional Device: UTP, UTQ, UTR, UTS, CLA, CMR, CAR/UTP, CAR/UTQ										
環型鬆緊帶褲頭接縫 Tubular Jacquard Elastic Waistband Attaching	C007L-W532-232/CR/UTP/CL/CX/RLP1	2	2	4	3.2	1.4-3.6	0.9~1.4	5/7	H / U	5000
	C007L-W532-3 ⑦ /CR/UTP/CL/CX/RLP	2	3	5	5.6/ 6.4	1.4-3.6	0.9~1.4	5/7	H / U	5000
	C007L-U532-232/CR/UTP/CL/CX/RLP1	2	2	3	3.2	1.4-3.6	0.9~1.4	5/7	H / U	5000
	C007L-U532-3 ⑦ /CR/UTP/CL/CX/RLP	2	3	4	5.6/ 6.4	1.4-3.6	0.9~1.4	5/7	H / U	5000
左切刀修布下擺車縫 Bottom Hemming with Left Side Fabric Trimmer	C007L-W81 ⑤ -2 ⑦ /CRL	1,2,3	2	4	4.0/ 4.8	1.4-3.6	0.9~1.4	5/7	H / U	5000
	C007L-W81 ⑤ -3 ⑦ /CRL	1,2,3	3	5	5.6/ 6.4	1.4-3.6	0.9~1.4	5/7	H / U	5000
	C007L-U81 ⑤ -2 ⑦ /CRL	1,2,3	2	3	4.0/ 4.8	1.4-3.6	0.9~1.4	5/7	H / U	5000
	C007L-U81 ⑤ -3 ⑦ /CRL	1,2,3	3	4	5.6/ 6.4	1.4-3.6	0.9~1.4	5/7	H / U	5000
	C007L-W81 ⑤ A-2 ⑦ /CRL	1,2,3	2	4	4.0/ 4.8	1.4-3.6	0.9~1.4	5/7	H / U	5000
	C007L-W81 ⑤ A-3 ⑦ /CRL	1,2,3	3	5	5.6/ 6.4	1.4-3.6	0.9~1.4	5/7	H / U	5000
	C007L-U81 ⑤ A-2 ⑦ /CRL	1,2,3	2	3	4.0/ 4.8	1.4-3.6	0.9~1.4	5/7	H / U	5000
	C007L-U81 ⑤ A-3 ⑦ /CRL	1,2,3	3	4	5.6/ 6.4	1.4-3.6	0.9~1.4	5/7	H / U	5000
選購配件 : UTP, UTQ, UTR, CMR, CAR/UTP, CAR/UTQ, CL/UTP Optional Device: UTP, UTQ, UTR, CMR, CAR/UTP, CAR/UTQ, CL/UTP										









規格

SPECIFICATIONS

C007LX - W122 - 240 /CH/DCLU

規格索引，詳細請參考P.65 Specification index, please refer to P.65

- ① 機種別 Mode
- ② 系列 Series
- ③ 網線方式 Covering Types
- ④ 功能 Function
- ⑤ 針板舌片 Needle Plate Finger
- ⑥ 針數 Needle Numbers
- ⑦ 針距 Needle gauge
- ⑧ 配件 Device
- ⑨ 馬達 Motor
U : U Series
H : H Series

C007L/C007LX										
鬆緊帶上帶邊縫 附左切刀 Elastic Attaching with Left Fabric Trimmer	C007L-W82 ⑤ -2 ⑦ /CRL/CHP/CL/RL	1,2,3	2	4	4.0/ 4.8	1.4-3.6	0.9~1.4	5/7	H / U	5000
	C007L-W82 ⑤ -3 ⑦ /CRL/CHP/CL/RL	1,2,3	3	5	5.6/ 6.4	1.4-3.6	0.9~1.4	5/7	H / U	5000
	C007L-U82 ⑤ -2 ⑦ /CRL/CHP/CL/RL	1,2,3	2	3	4.0/ 4.8	1.4-3.6	0.9~1.4	5/7	H / U	5000
	C007L-U82 ⑤ -3 ⑦ /CRL/CHP/CL/RL	1,2,3	3	4	5.6/ 6.4	1.4-3.6	0.9~1.4	5/7	H / U	5000
	C007L-W82 ⑤ A-2 ⑦ /CRL/CHP/CL/RL	1,2,3	2	4	4.0/ 4.8	1.4-3.6	0.9~1.4	5/7	H / U	5000
	C007L-W82 ⑤ A-3 ⑦ /CRL/CHP/CL/RL	1,2,3	3	5	5.6/ 6.4	1.4-3.6	0.9~1.4	5/7	H / U	5000
	C007L-U82 ⑤ A-2 ⑦ /CRL/CHP/CL/RL	1,2,3	2	4	4.0/ 4.8	1.4-3.6	0.9~1.4	5/7	H / U	5000
	C007L-U82 ⑤ A-3 ⑦ /CRL/CHP/CL/RL	1,2,3	3	5	5.6/ 6.4	1.4-3.6	0.9~1.4	5/7	H / U	5000
選購配件 : UTP, UTQ, CMR, CAR/UTQ, CL/UTP Optional Device: UTP, UTQ, CMR, CAR/UTQ, CL/UTP										



RH

弧型筒式超高速繙縫機

Ultra High Speed Cylinder Bed Interlock Stitch Machine



內縮式床台

縫製物更靠近針孔，車縫定位精準，車縫時更加順暢就手

The Recessed Machine Bed

With the recessed machine bed, sewing material comes closer to the needle hole, thus provides more precise easier, and smoother sewing.



弧型短筒座的設計

改良傳統式繙縫機的稜角筒座，RH的弧型設計讓送料的縫製過程更順暢，且使操作時的取、放更為省力，可因應廣泛的飾蓋縫紉工程，增加延伸蓋就可以車縫邊或包帶之縫紉工程

Shortened cylinder bed with arc shape design

Improved from traditional interlock stitch machine, this new RH arc design leads to a more easier sewing process. It is also applicable for covering seam and for tape binding with extended cover.



直覺式操作

RH 弧型筒式繙縫機，採直覺式放入布料，有效降低因人工疲勞操作所造成的不良率、提升生產效率。更適用於 T 恤圓領等縫製工藝。

More user-friendly operation

This new design makes fabric feeding more user-friendly and makes sewing process more easier and increases productivity. It is the best option for sewing T-Shirt's ribbed collar.



RCH-3M [三合一] 一般平縫 / 下擺車縫 / 拷克倒骨蓋縫

三合一 平縫，折下擺，倒骨，更換作業組裝方便，多樣化功能，提供生產廠商高效率低成本。

RCH-3M [3 in 1] : GENERAL SEAMING/BOTTOM HEMMING/COVERING STITCH (Fold-down type)

3-in-1 model for multifunctional and efficient production with lower cost.



C007L_W122_356_RH_DCLH1_1

C007KP SERIES FEATURES



內縮式床台

縫製物更靠近針孔，車縫定位精準，車縫時更加順暢就手

The Recessed Machine Bed

With the recessed machine bed, sewing material comes closer to the needle hole, thus provides more precise easier, and smoother sewing.



新設計上下切刀組

新設計氣、電動上下切刀組，出刀穩定精確，切線俐落，調整容易

Brand New Top and Under Trimmer

The newly designed pneumatic, electric top & under knife combination have fast, stable and precise. Trims thread neatly. Handy operation, easy to adjust.



針棒與勾針的新油封結構

新的油封設計強化了機構的油附著力，減少了潤滑油甩出。同時使用高耐磨材料，顯著提高性能及替代

New Oil Sealing Technology

New oil sealing structure used on needle bar and looper mechanism can efficiently avoid oil splash. New wear-resistant material also enhances performance and durability.



短筒座的設計

操作性能優越，可因應廣泛的飾蓋縫紉工程，增加延伸蓋就可以車縫邊或包帶之縫紉工程

Recessed Cylinder Bed

The recessed cylinder bed on the front cover is shortened. The short cylinder has superior operating performance, which can be applied to the extensive covering seam. Hemming or wrapping can be sewed just by increasing the extended cover.

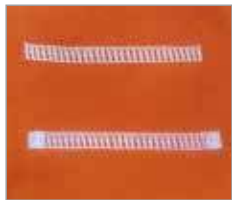

密縫裝置

藉由縮短送具行程，在車縫起始或結束進行密縫的功能，確保縫線不易脫落，提高車縫品質，基本車為腳踏板控制，電動和氣動控制為選配

Condense Stitching Device

By reducing the strokes of feed dog, at the beginning and the end of sewing, condense stitching reinforces the stitches. This enhances the sewing sturdiness and quality. Basic model is controlled by pedal. Electric and pneumatic controls are optional.



新設計上夾線裝置

出刀迅速精準，夾線穩定

Brand New Design Upper Thread Gripper

The newly designed upper thread gripper provides fast, precise movement and stable thread gripper.



送具並列式調整鈕設計

[專利] 前送齒及後送齒，藉由全新並列式調整鈕設計，可獨自調整同步或正逆差動，指標刻度方便使用者進行精確調整前後送齒，大大提升操作者使用上的便利性

Front and Rear Feed Dog Minute Adjustment

[Patent] Synchronization or forward / reverse differential of front and rear feed dog can be finely adjusted alone by the brand new parallel adjustable feed dog control knobs. Furthermore, the indicator scales is easy for user to adjust the feeding precisely, which improves ease of operation greatly.

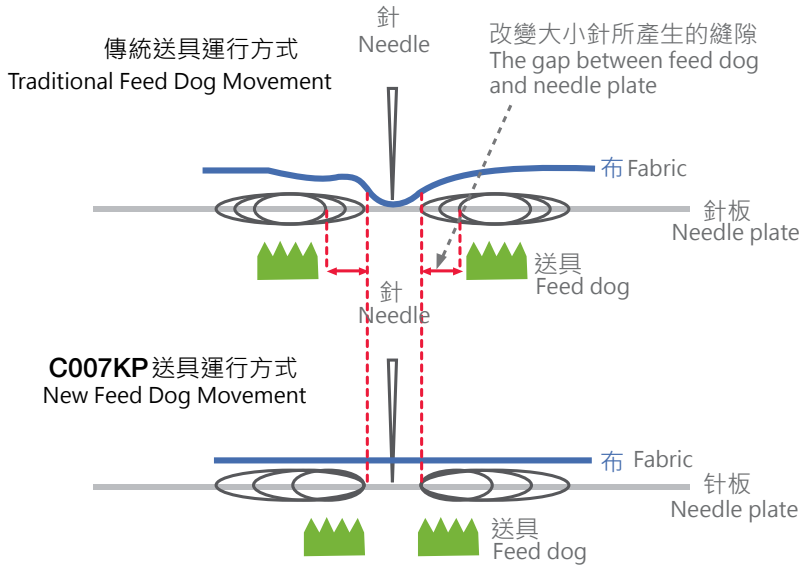

全新移動送齒之傳動設計

[專利] 後、前送齒依據橢圓式運動方式，統一由針孔向外運動延伸，縫製物可獲得精準穩定送布，也不會因為過骨或差動而前、後送具產生間隙，影響車縫品質

Brand New Differential Feed Dog Driving Design

[Patent] The front and rear feed dog move elliptically, and centrally, a direct extension from needle hole, thus enable sewing material to get precise and stable feeding. Therefore, the sewing quality will not be affected by the clearance between front and rear feed dog which is resulted from the cross seam or differential action.



雙天秤挑線控線組

全新雙天秤挑線控線組的設計，縫製厚、薄布料皆適用，車縫適用範圍更廣，適用性更高

Dual Thread Take-up Mechanism

The brand new design of dual thread take-up lever thread tension combination is ideal for both heavy and light fabric. Sewing applicable range is wider and the applicability is higher.

- 中厚布料 (Medium heavy fabric)
- 薄布料 (Light fabric)

規格

SPECIFICATIONS

C007KP - W122 - 2 40 /CH/DCKU

規格索引，詳細請參考P.65 Specification index, please refer to P.65

- ① 機種別 Mode
- ② 系列 Series
- ③ 網線方式 Covering Types
- ④ 功能 Function
- ⑤ 針板舌片 Needle Plate Finger
- ⑥ 針數 Needle Numbers
- ⑦ 針距 Needle gauge
- ⑧ 配件 Device
- ⑨ 馬達 Motor
U : U Series
H : H Series

C1 Device

	⑥	④	⑤	⑦	⑧	⑨	⑨	
C007KP-W122-⑥⑦/CH/(⑨)	2	4	3.2/ 4.0/ 4.8	1.4 ~ 3.6	0.3 ~ 2.9	5/7	H / U	6000
	3	5	4.8/ 5.6/ 6.4	1.4 ~ 3.6	0.3 ~ 2.9	5/7	H / U	6000
C007KP-W162-⑥⑦/CH/(⑨)	2	4	4.0/ 4.8	1.4 ~ 3.6	0.3 ~ 2.9	5/7	H / U	6000
	3	5	4.8/ 5.6/ 6.4	1.4 ~ 3.6	0.3 ~ 2.9	5/7	H / U	6000
C007KP-W122-⑥⑦/CH-4M/(⑨)	3	5	5.6/ 6.4	1.4 ~ 3.6	0.3 ~ 2.9	5/7	H / U	6000



C007KP-W122-356/CH/UTP

一般平縫 / 下擺車

本機型為雙面飾繃縫筒車之基本機型，可裝配附件進行多種功能車縫例如：內衣褲、運動衫接縫及下擺車縫(附可調式下擺車縫組)

GENERAL SEAMING / BOTTOM HEMMING

Basic model of interlock stitch machine with double side cover-stitching. It is available for various sewing by optional devices. Such as plain seaming and bottom hemming for underwears, sportswears, etc... (equipped with adjustable hemming set)

W122 : 薄中厚多功能對應針板

W162 : 高行程

W122 : Light / Medium / Heavy Material Multi-function

W162 : High needle bar stroke



CH-4M [四合一]

一般平縫 / 下擺車縫 / 拷克倒骨蓋縫 / 上帶滾邊車縫

四合一 平縫，折下擺，倒骨，上帶滾邊，更換作業組裝方便，多樣化功能，提供生產廠商高效率低成本。

CH-4M [4 in 1]

GENERAL SEAMING / BOTTOM HEMMING / COVERING (Fold-down Type) / TAPE BINDING.

4-in-1 model for multifunctional and efficient production with lower cost.

選購配件 OPTIONAL DEVICE

UTP, UTQ, UTR, UTS, CLA, CMR, CAR/UTP, CAR/UTQ

規格 SPECIFICATIONS C007KP - W81 2 A - 2 32/ CRL / DCKU

規格索引，詳細請參考P.65 Specification index, please refer to P.65

- ① 機種別 Mode
- ② 系列 Series
- ③ 網線方式 Covering Types
- ④ 功能 Function
- ⑤ 針板舌片 Needle Plate Finger
- ⑥ 針數 Needle Numbers
- ⑦ 針距 Needle gauge
- ⑧ 配件 Device
- ⑨ 馬達 Motor
U : U Series
H : H Series

C2 Device



C007KP-W812A-⑥⑦/CRL/(⑨)	2	4	3.2/ 4.0/ 4.8	1.4 ~ 3.6	0.3 ~ 2.9	5/7	H / U	4500
	3	5	5.6/ 6.4	1.4 ~ 3.6	0.3 ~ 2.9	5	H / U	4500



左切刀修布下擺車縫

附左切刀修齊布邊後，再進行下擺車縫工程，適用於車縫T恤、汗衫之下擺等

BOTTOM HEMMING WITH LEFT SIDE FABRIC TRIMMER

Left hand side fabric trimming before hemming. For sleeve opening and bottom of underwears, T-shirt, or sportswears, etc...

適用規格
APPLICABLE SPEC.

W812, U812

* 薄布料建議選購 W812
Recommended for thin fabrics

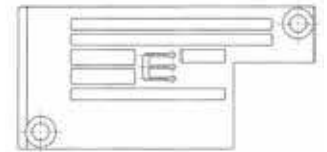

C007KP-W812-356/CRL

選購配件 OPTIONAL DEVICE

UTP, UTQ, UTR, CL, CMR, CAR/UTP, CAR/UTQ

C3 Device



C007KP-W222-⑥⑦/CQ/(⑨)	2	4	4.0/ 4.8	1.4 ~ 3.6	0.3 ~ 2.9	5/7	H / U	6000
	3	5	5.6/ 6.4	1.4 ~ 3.6	0.3 ~ 2.9	5/7	H / U	6000
C007KP-W222-⑥⑦/CQA/(⑨)	3	5	5.6	1.4 ~ 3.6	0.3 ~ 2.9	5/7	H / U	5000



CQ:上帶滾邊車縫

適用於內衣褲、T恤之領口、褲管口等上帶滾邊之車縫工程
註：滾邊器尺寸為入布端寬1-3/8"，出布時折成三折，出口端成品寬為1/2"

CQ:TAPE BINDING

For tape binding on openings of leg or neck of underwears, T-shirts, etc...
Remark : Binder's opening size is 1-3/8" wide and finished size is 1/2" wide in three folds.

C007KP-W222-356/CQ



CQA:中厚毯上帶滾邊車縫

適用於中厚毯上帶滾邊之車縫工程
註：滾邊器尺寸為入布端寬72mm，出布時折成二折，出口端成品寬為36mm

CQA:BLANKET CARPET TAPE BINDING

For medium and heavy material tape binding.
Remark : Binder's opening size is 72mm wide and finished size is 36mm wide in two folds.

選購配件 OPTIONAL DEVICE

CLA, FA

C007KP-W222-356/CQA

規格

SPECIFICATIONS

C007KP - W322 - 3 56 /CC/DCKU

規格索引，詳細請參考P.65 Specification index, please refer to P.65

- ① 機種別 Mode
- ② 系列 Series
- ③ 網線方式 Covering Types
- ④ 功能 Function
- ⑤ 針板舌片 Needle Plate Finger
- ⑥ 針數 Needle Numbers
- ⑦ 針距 Needle gauge
- ⑧ 配件 Device
- ⑨ 馬達 Motor
U : U Series
H : H Series

C4 Device

	⑥	⑤	⑦	⑧	⑨	⑨	⑨	
C007KP-W322-3⑦/CC/(⑨)	3	5	5.6/6.4	1.4 ~ 3.6	0.3 ~ 2.9	5	H / U	6000
C007KP-W322A-3⑦/CC/(⑨)	3	5	5.6/6.4	1.4 ~ 3.6	0.3 ~ 2.9	5	H / U	6000
C007KP-W322-3⑦/CE/(⑨)	3	5	5.6/6.4	1.4 ~ 3.6	0.3 ~ 2.9	5	H / U	6000

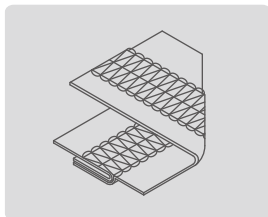

CC

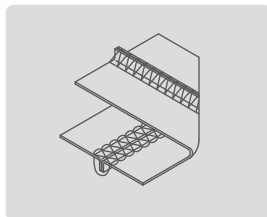

CE



CC

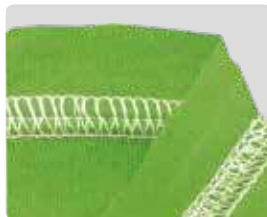

CE

拷克倒骨蓋縫

CC 倒骨型：適用於4線包縫之蓋縫

W322A為兩用型，針板與送具改用W122規格，並附CH組

CE 立骨型：適用於3線包縫之蓋縫

配件盒另附有CC倒骨規格之牛角(導布片)

OVERLOCK-SEAM COVERING STITCH

CC Fold-down type : For 4-thread overlock-seam covering stitch
W322A is dual-purpose specification, which is with W122's needle plate, feed dog and CH set.

CE Flattening type : For 3-thread overlock-seam covering stitch, and an extra guide of overlock-seam (CC specification, fold-down type) is included in the accessory box.

選購配件 OPTIONAL DEVICE

UTP, UTQ, UTR, UTS, CLA, CMR, CAR/UTP, CAR/UTQ

C5 Device

	⑥	⑤	⑦	⑧	⑨	⑨	⑨	
C007KP-W922-4⑦/CW/(⑨)	4	6	5.6/6.0/6.4	1.4 ~ 3.6	0.3 ~ 2.9	5	H / U	6000



CW

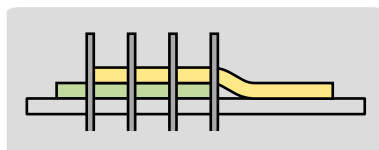

四針六線搭接縫

適用於一般內衣褲二片布接縫處之接縫和補強，附有專屬之導邊器，可使二片布順暢縫合

FOUR-NEEDLE FLAT SEAMING

For flat seaming 2 pieces of fabric. Equipped with fabric guide for easy operation.

選購配件 OPTIONAL DEVICE

UTQ, UTS, CL, CMR, CAR/UTQ

規格 SPECIFICATIONS C007KP - W522 - 2 40 /CR /FE

規格索引，詳細請參考P.65 Specification index, please refer to P.65

- ① 機種別 Mode
- ② 系列 Series
- ③ 網線方式 Covering Types
- ④ 功能 Function
- ⑤ 針板舌片 Needle Plate Finger
- ⑥ 針數 Needle Numbers
- ⑦ 針距 Needle gauge
- ⑧ 配件 Device

C6 Device

	⑥	⑦	⑦	mm	mm	mm	S.P.M. (Max)
C007KP-W522-⑥⑦/CR/FE	2	4	3.2/ 4.0/ 4.8	1.4 ~ 3.6	0.3 ~ 2.9	5	4500
	3	5	4.8/ 5.6/ 6.4	1.4 ~ 3.6	0.3 ~ 2.9	5	4500
C007KP-W522-⑥⑦/CR/FFC	2	4	3.2/ 4.0/ 4.8	1.4 ~ 3.6	0.3 ~ 2.9	5	4500
	3	5	4.8/ 5.6/ 6.4	1.4 ~ 3.6	0.3 ~ 2.9	5	4500
C007KP-W522-⑥⑦/CR/SMK	2	4	3.2/ 4.0/ 4.8	1.4 ~ 3.6	0.3 ~ 2.9	5	4500
	3	5	4.8/ 5.6/ 6.4	1.4 ~ 3.6	0.3 ~ 2.9	5	4500
C007KP-W522-⑥⑦/CR/STC	2	4	3.2/ 4.0/ 4.8	1.4 ~ 3.6	0.3 ~ 2.9	5	4500
	3	5	4.8/ 5.6/ 6.4	1.4 ~ 3.6	0.3 ~ 2.9	5	4500



C007KP-W522-356/CR/FE



C007KP-W522-356/CR/FFC

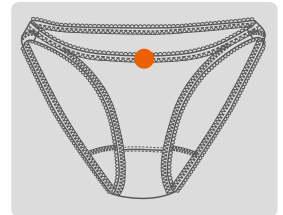
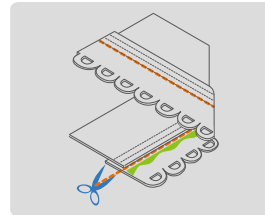

鬆緊帶 / 蕾絲鬆緊帶上帶車縫附右切刀

經由上送帶裝置，控制長度與張力，附右切刀修布裝置，能於車縫前將布修齊，更能提高車縫品質，如女用內衣褲之鬆緊帶或蕾絲鬆緊帶車縫

- FFC:** 機械式送帶
- FE:** 簡易電子式送帶
- SMK:** 電子計數式送帶
 - SMK1-C-01 附定位器，適合簡易伺服或離合器馬達
 - SMK1-C-02 以中繼線，連接伺服馬達
- STC:** 张力控制式送帶
 - STC1-U-01 附定位器，適合簡易伺服或離合器馬達
 - STC1-U-02 以中繼線，連接伺服馬達

選購配件 OPTIONAL DEVICE
CL, LF-A, LS-A, CSA, CSB

ELASTIC / LACE ATTACHING WITH RIGHT FABRIC TRIMMER

Top feeding devices ensure even length and tension controlled by electric digital controller, with right side fabric trimmer for elastic or lace attaching smoothly and properly on women's underwears.

- FFC:** Mechanic type tape feeding.
- FE:** Simple electric type tape feeding.
- SMK:** Electric metering type tape feeding
 - SMK1-C-01 with synchronizer for simple servo motor or clutch motor
 - SMK1-C-02 Connected to servo motor by encoder cable.
- STC:** Tension sensor type tape feeding
 - STC1-U-01 with synchronizer for simple servo motor or clutch motor
 - STC1-U-02 Connected to servo motor by encoder cable.

規格 SPECIFICATIONS C007KP-W532-240/CR/CX/UTP/RLP/DCKU

規格索引，詳細請參考P.65 Specification index, please refer to P.65

- ① 機種別 Mode
 - ② 系列 Series
 - ③ 網線方式 Covering Types
 - ④ 功能 Function
 - ⑤ 針板舌片 Needle Plate Finger
 - ⑥ 針數 Needle Numbers
 - ⑦ 針距 Needle gauge
 - ⑧ 配件 Device
 - ⑨ 馬達 Motor
U : U Series
H : H Series
- *UTP 請參考 Please refer to P.113

C7 Device

	⑥	⑦	⑦	⑧	⑨	⑨	⑨	
C007KP-W532-⑥⑦/CR/CX/UTP/RLP/(⑨) *1	2	4	3.2/ 4.0/ 4.8	1.4 ~ 3.6	0.3 ~ 2.9	5	H / U	4500
	3	5	4.8/ 5.6/ 6.4	1.4 ~ 3.6	0.3 ~ 2.9	5	H / U	4500
C007KP-W532-⑥⑦/CR/CX/UTR/RLP/(⑨) *2	2	4	3.2/ 4.0/ 4.8	1.4 ~ 3.6	0.3 ~ 2.9	5	H / U	4500
	3	5	4.8/ 5.6/ 6.4	1.4 ~ 3.6	0.3 ~ 2.9	5	H / U	4500



環型鬆緊帶褲頭接縫附右切刀修布邊

將環型平織鬆緊帶與衣物接縫適用於男女內褲褲腰之鬆緊帶縫合，配合右切刀修布裝置，更能提高縫製品質

- *1: 氣動切線，含氣動式吸布屑組
- *2: 電動切線，需另外搭配吸風馬達 (CSA或CSB)

TUBULAR JACQUARD ELASTIC WAISTBAND ATTACHING WITH RIGHT SIDE FABRIC TRIMMER

For tubular elastic or lace waistband attaching on men's or women's brief, with right hand side fabric trimmer to increase sewing quality and efficiency.

C007KP-W532-356/CR/CX/CL/UTP

- *1: Pneumatic thread trimmer, including fabric waste suction set
- *2: Electric thread trimmer, an optional suction motor (CSA or CSB) is required.

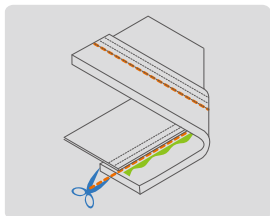
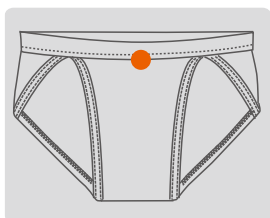

選購配件 OPTIONAL DEVICE
CL* , CAR/UTQ , CMR , CSA , CSB

- *建議採用CL後拉輪，以提升鬆緊帶車縫效率
- *CL rear puller is recommended for elastic band attaching

① ② ③ ④ ⑤ ⑥ ⑦ ⑧ * ⑨

規格 SPECIFICATIONS C007KP- W822- 2 40/CRL/CHP/UTP/DCKU

規格索引，詳細請參考P.65 Specification index, please refer to P.65

- ① 機種別 Mode
 - ② 系列 Series
 - ③ 網線方式 Covering Types
 - ④ 功能 Function
 - ⑤ 針板舌片 Needle Plate Finger
 - ⑥ 針數 Needle Numbers
 - ⑦ 針距 Needle gauge
 - ⑧ 配件 Device
 - ⑨ 馬達 Motor
U : U Series
H : H Series
- *UTP 請參考 Please refer to P.113

C8 Device

	⑥	⑦	⑧	⑨	S.P.M. (Max)			
C007KP-W822-⑥⑦/CRL/CHP(CY)/UTP/(⑨)	2	4	3.2/ 4.0/ 4.8	1.4 ~ 3.6	0.3 ~ 2.9	5	H / U	4500
	3	5	5.6/ 6.4	1.4 ~ 3.6	0.3 ~ 2.9	5	H / U	4500



C007KP-W822-356/CRL/CL/CHP/UTP

**[二合一]氣動式下擺車縫 / 環型鬆緊帶折縫
附左切刀修布邊功能**

氣動式布料導邊器能將布料及鬆緊帶順暢的捲折，此外左切刀切齊後再進行縫紉，可增加包縫工程之品質與效率，適用於男內褲、運動褲等褲頭鬆緊帶包縫

**[2 IN 1]
PNEUMATIC HEMMING / TUBULAR ELASTIC TAPE HEMMING WITH LEFT EDGE TRIMMER**

With pneumatic driving folder to fold fabric and insert elastic smoothly, left hand side fabric trimming before hemming increases sewing quality & efficiency. For hemming sleeve opening and bottom of underwears, T-shirts, or sportswears, etc...

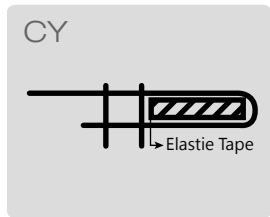
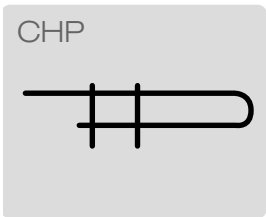
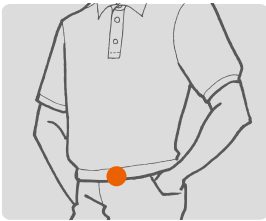

CHP (CRL 163)
氣動式下擺車縫
Pneumatic Hemming



CY (CRL178-A)
氣動式環型鬆緊帶折縫
Pneumatic Tubular Elastic Tape Hemming

適用規格 APPLICABLE SPEC
W821, W822, W823, U821, U822, U823
選購配件 OPTIONAL DEVICE
CL*, RL, UTQ, CMR, CAR/UTQ

*建議採用CL後拉輪，以提升鬆緊帶車縫效率
*CL rear puller is recommended for elastic band attaching

規格

SPECIFICATIONS

C007KP - W152 - 3 56/ CZ/ RLQ/ DCKU

規格索引，詳細請參考P.65 Specification index, please refer to P.65

- ① 機種別 Mode
- ② 系列 Series
- ③ 網線方式 Covering Types
- ④ 功能 Function
- ⑤ 針板舌片 Needle Plate Finger
- ⑥ 針數 Needle Numbers
- ⑦ 針距 Needle gauge
- ⑧ 配件 Device
- ⑨ 馬達 Motor
U : U Series
H : H Series

C9 Device

	⑥	⑤	⑦	④	③	②	①	⑨
C007KP-W152-3⑦/CZ/RLQ/(⑨)	3	5	5.6/ 6.4	1.4 ~ 3.6	0.3 ~ 2.9	5	H / U	6000
C007KP-W152-3⑦/CZP/RLQ/(⑨)	3	5	5.6/ 6.4	1.4 ~ 3.6	0.3 ~ 2.9	5	H / U	6000



C007KP-W152-356/CZ/UTP

環型羅紋褲頭鬆緊帶包縫

CZ:氣動式 / CZP:膝動式

將環型羅紋鬆緊帶縫入原體，適用於男女內褲、褲腰之羅紋鬆緊帶包縫再配合自動切線裝置及筒型衣物撐開滾輪組，更能提高縫製效率
註：本機型標準配備二折式導布片，可另訂三折式導布片

TUBULAR ELASTIC WAISTBAND ATTACHING

CZ:PNEUMATIC TYPE / CZP: MANUAL TYPE

Attaching tubular elastic tape onto waistband, suitable for briefs. With auto-trimming and tubular extending roller can increase sewing quality and efficiency.

Remark : Two fold fabric guide is standard, three fold fabric guide is optional.

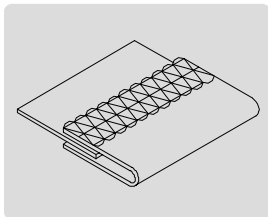
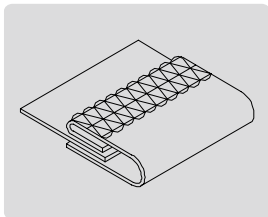
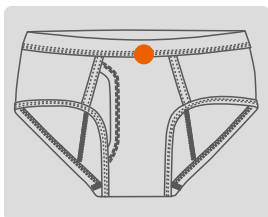

三折 3-Fold
(CZ01K,CZ03K)

兩折 2-Fold
(CZ21K,CZ22K)

RLQ



機型 MODEL	選購配件 OPTIONAL DEVICE
CZ	CL* , UTP , UTQ , CMR , CAR/UTP , CAR/UTQ
CZP	CL* , UTP , UTQ , UTR , UTS , CMR , CAR/UTP , CAR/UTQ

*建議採用CL後拉輪，以提升鬆緊帶車縫效率

*CL rear puller is recommended for elastic band attaching

規格 SPECIFICATIONS C007KP - W542 - 2 40 /CFC

規格索引，詳細請參考P.65 Specification index, please refer to P.65

- ① 機種別 Mode ④ 功能 Function ⑦ 針距 Needle gauge ⑨ 馬達 Motor
- ② 系列 Series ⑤ 針板舌片 Needle Plate Finger ⑧ 配件 Device U : U Series
- ③ 網線方式 Covering Types ⑥ 針數 Needle Numbers H : H Series

C10 Device

	⑥	④	⑦	⑦	⑨	⑧	⑨
C007KP-W542-⑥⑦/CFC	2	4	4.0/4.8	1.4 ~ 3.6	0.3 ~ 2.9	5/7	6000
	3	5	5.6/6.4	1.4 ~ 3.6	0.3 ~ 2.9	5/7	6000
C007KP-W542-⑥⑦/SMK	2	4	4.0/4.8	1.4 ~ 3.6	0.3 ~ 2.9	5/7	6000
	3	5	5.6/6.4	1.4 ~ 3.6	0.3 ~ 2.9	5/7	6000
C007KP-W542-⑥⑦/STC	2	4	4.0/4.8	1.4 ~ 3.6	0.3 ~ 2.9	5/7	6000
	3	5	5.6/6.4	1.4 ~ 3.6	0.3 ~ 2.9	5/7	6000



SMK



STC

鬆緊帶折縫

由下送帶配件，能有效控制鬆緊帶之鬆緊度，配合三折或二折折布喇叭及鬆緊帶壓縫，可精確完美的進行短褲、內褲等褲腳及褲頭之鬆緊帶折縫

CFC: 機械式送帶

SMK: 電子計數式送帶

SMK1-D-01 附定位器，適合簡易伺服或離合器馬達

SMK1-D-02 以中繼線，連接伺服馬達

STC: 張力控制式送帶

STC1-B-01 附定位器，適合簡易伺服或離合器馬達

STC1-B-02 以中繼線，連接伺服馬達

ELASTIC HEMMING

Elastic hemming evenly length and elasticity is controlled by tape feeding device. Great for seam covering with two or three plies hemming binder on elastic for waistband or leg opening of briefs and shorts, etc...

CFC: Mechanic type tape feeding

SMK: Electric metering type tape feeding

SMK1-D-01 with synchronizer for simple servo motor or clutch motor

SMK1-D-02 Connected to servo motor by encoder cable Tension

STC: sensor type tape feeding

STC1-B-01 with synchronizer for simple servo motor or clutch motor

STC1-B-02 Connected to servo motor by encoder cable

可選擇之折布喇叭 Optional Binder			
喇叭型式 Binder Type	機型 Model	喇叭代號 Binder No.	成品尺寸 Finished Size
	2	B523	9mm
	2A	B523A	12mm
	3	B524	9mm
	3A	B524A	12mm

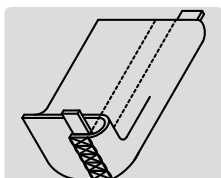
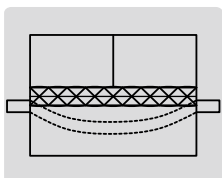
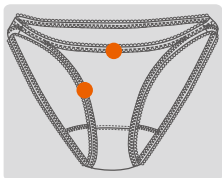

選購配件 OPTIONAL DEVICE
FH, CL*

*建議採用CL後拉輪，以提升鬆緊帶車縫效率

*CL rear puller is recommended for elastic band attaching

規格

SPECIFICATIONS

C007KP - W122 - 2 40/ FFT/ CH/ DCKU

規格索引，詳細請參考P.65 Specification index, please refer to P.65

- ① 機種別 Mode
- ② 系列 Series
- ③ 網線方式 Covering Types
- ④ 功能 Function
- ⑤ 針板舌片 Needle Plate Finger
- ⑥ 針數 Needle Numbers
- ⑦ 針距 Needle gauge
- ⑧ 配件 Device
- ⑨ 馬達 Motor
U : U Series
H : H Series

C11 Device

	⑥	④	⑦	⑤	③	②	⑧	⑨	
C007KP-W122-⑥⑦/FFT/CH/⑨	2	4	4.0/ 4.8	1.4 ~ 3.6	0.3 ~ 2.9	1~5.5	5	H / U	4500
	3	5	5.6/ 6.4	1.4 ~ 3.6	0.3 ~ 2.9	1~5.5	5	H / U	4500
C007KP-W131-⑥⑦/FFT/CH/⑨	2	4	4.0/ 4.8	1.4 ~ 3.6	0.3 ~ 2.9	1~5.5	5	H / U	4500
	3	5	5.6/ 6.4	1.4 ~ 3.6	0.3 ~ 2.9	1~5.5	5	H / U	4500
C007KP-W132-⑥⑦/FFT/CH/⑨	2	4	4.0/ 4.8	1.4 ~ 3.6	0.3 ~ 2.9	1~5.5	5	H / U	4500
	3	5	5.6/ 6.4	1.4 ~ 3.6	0.3 ~ 2.9	1~5.5	5	H / U	4500
C007KP-W812A-⑥⑦/FFT/CRL/⑨	2	4	4.0/ 4.8	1.4 ~ 3.6	0.3 ~ 2.9	1~5.5	5	H / U	4500
	3	5	5.6/ 6.4	1.4 ~ 3.6	0.3 ~ 2.9	1~5.5	5	H / U	4500
C007KP-U812A-⑥⑦/FFT/CRL/⑨	2	4	4.0/ 4.8	1.4 ~ 3.6	0.3 ~ 2.9	1~5.5	5	H / U	4500
	3	5	5.6/ 6.4	1.4 ~ 3.6	0.3 ~ 2.9	1~5.5	5	H / U	4500
C007KP-W812A-⑥⑦/FFT/CRL/CW/⑨	4	6	5.6/ 6.0/ 6.4	1.4 ~ 3.6	0.3 ~ 2.9	1~5.5	5	H / U	4500



FFT 上送布功能

專利優化前後移動送具之結構設計，有效送布行程大，車縫送布更穩定

FFT TOP FEEDING FUNCTION

Back and forth moving feed dog is designed by patent and improved mechanism. The effective feeding stroke is bigger, and fabric feeding is more stable.

選購配件 OPTIONAL DEVICE
UTP, UTR

* 薄布料建議選購 W 8 1 2
Recommended for thin fabrics

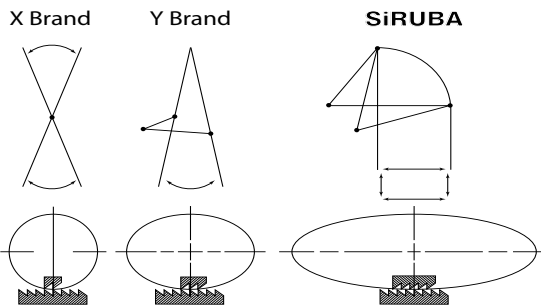
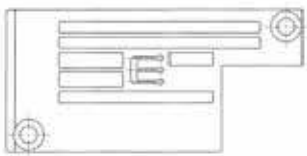

U007 SERIES FEATURES

U007 直驅超小筒型繙縫機 Ultra Small Cylinder Bed Interlock Stitch Machine



128mm角逐業界最細的小筒設計，過往縫製困難的童裝袖口也可輕易車縫

128mm top-class small cylinder bed design. Conventionally difficult-to-sew small diameter tubular parts of children's clothing can be easily operated.



斜面筒嘴設計，縫製衣物著脫容易；筒身長64mm，方便長袖衣物套入車縫

Sharp entrance design allows quick placement/removal of material. 64mm cylinder length makes sewing long sleeve cuffs easily.



送布牙下送具，有別於皮帶傳送方式，送布力更加更耐用

Feed-dog design, more durable and great performance of fabric-feeding.



自動切線系列新設計氣/電動上下切刀組，出刀迅速穩定精準，切線俐落，輕順低噪音調整容易

Auto trimmer with newly designed pneumatic / electric trimming system, trims precisely and stably, reduce sound and easy to adjust.



圓形粗細針縫目調整鈕的設計，隨心所欲精確調整縫目長短

Circular stitch length adjustment button, easily to adjust stitch length.

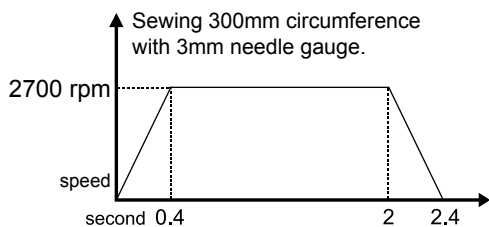

300mm圓周長不需3秒即可完工，2700rpm是對應小筒車縫的完美速度

Just take less than 3 seconds to complete 300mm circumference sewing; 2700rpm is the perfect speed for ultra small cylinder.



UCH-3M [三合一] 一般平縫 / 下擺車縫 / 拷克倒骨蓋縫

三合一 平縫，倒骨，折下擺，更換作業組裝方便，多樣化功能，提供生產廠商高效率低成本。

UCH-3M [3 in 1] : GENERAL SEAMING/BOTTOM HEMMING/COVERING STITCH (Fold-down type)
3-in-1 model for multifunctional and efficient production with lower cost.



① ③ ④ ⑤ ⑥ ⑦ * *





規格

SPECIFICATIONS

U007 - W122 - 2 40/ UCH-3M/ UTT(UTU)

規格索引，詳細請參考P.65 Specification index, please refer to P.65

- ① 機種別 Mode
 - ② 系列 Series
 - ③ 網線方式 Covering Types
 - ④ 功能 Function
 - ⑤ 針板舌片 Needle Plate Finger
 - ⑥ 針數 Needle Numbers
 - ⑦ 針距 Needle gauge
 - ⑧ 配件 Device
 - ⑨ 馬達 Motor
U : U Series
H : H Series
- *UTT 請參考 Please refer to P.113

U007					
U007-W122-2 ⑦ /UCH-3M	2	4	4.0/ 4.8	5	2700
U007-W122-3 ⑦ /UCH-3M	3	5	5.6/ 6.4	5	2700
U007-W122-2 ⑦ /UCH-3M/UTT(UTU)*	2	4	4.0/ 4.8	5	2700
U007-W122-3 ⑦ /UCH-3M/UTT(UTU)*	3	5	5.6/ 6.4	5	2700
U007-W122-2 ⑦ /UCH-3M/UTX(UTY)*	2	4	4.0/ 4.8	5	2700
U007-W122-3 ⑦ /UCH-3M/UTX(UTY)*	3	5	5.6/ 6.4	5	2700

S007K/KD SERIES FEATURES



自動切線系列新設計上夾線裝置，出刀迅速精準，夾線穩定

Auto trimmer with newly designed upper thread holder, trims precisely and stably.



PCH-3M [三合一] 一般平縫 / 下擺車縫 / 拷克倒骨蓋縫

三合一平縫，倒骨，折下擺，更換作業組裝方便，多樣化功能，提供生產廠商高效率低成本。

PCH-3M (3 in 1): GENERAL SEAMING/BOTTOM HEMMING/COVERING STITCH (Fold-down type)

3-in-1 model for multifunctional and efficient production with lower cost.



超小筒徑圓周只有180毫米，車縫小孔徑圓筒針織物，更加方便就手

The small cylinder designed with 180 mm, the extremely small circumference makes sewing operation smoother.



外置式底線分線盤，置於機體前方，調整容易，拆裝方便，可輕易清除絞線

Front exposed looper thread take-up mechanism makes cleaning and adjusting more convenient. After fine tuning the looper thread eyelet holder, sewing can be more accurate.



調整式進布誘導器，活動式壓腳，車縫適用性更廣

Adjustable folder, flexible presser foot, able to accommodate wider range of sewing items.



超短筒的設計，筒邊至中針距離只有39毫米，採密封式之側蓋設計，操作方便順暢

Extremely small tubule design, the distance from cylinder edge to middle needle is only 31 mm. Sealed side cover makes operation more convenient.



密縫裝置

藉由縮短送具行程，在車縫起始或結束進行密縫的功能，確保縫線不易脫落,提高車縫品質，基本車為腳踏板控制，電動和氣動控制為選配

Condense Stitching Device

By reducing the strokes of feed dog, at the beginning and the end of sewing, condense stitching reinforces the stitches. This enhances the sewing sturdiness and quality. Basic model is controlled by pedal. Electric and pneumatic controls are optional.

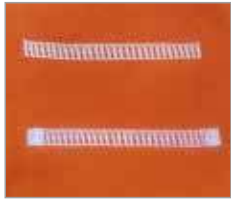

自動切線系列新設計氣/電動上下切刀組，出刀迅速穩定精準，切線俐落，輕順低噪音調整容易

Auto trimmer with newly designed pneumatic / electric trimming system, trims precisely and stably, reduce sound and easy to adjust.



全新設計之內藏式定位器，定位精準，徹底解決外置式定位器，不易安裝，調整及定位不穩之情形

Newly designed built-in synchronizer, makes position precisely and stably, easy to adjust.



圓形粗細針縫目調整鈕的設計，隨心所欲精確調整縫目長短

Circular stitch length adjustment button, easily to adjust stitch length.



小型投射LED照明，穿線或調整機針作業方便（選配）

LED light, convenient for threading or adjusting the needle (Optional).

規格 SPECIFICATIONS S007KD - W122 - 2 40/ PCH-3M/ DSKU

規格索引，詳細請參考P.65 Specification index, please refer to P.65

- ① 機種別 Mode
- ② 系列 Series
- ③ 網線方式 Covering Types
- ④ 功能 Function
- ⑤ 針板舌片 Needle Plate Finger
- ⑥ 針數 Needle Numbers
- ⑦ 針距 Needle gauge
- ⑧ 配件 Device
- ⑨ 馬達 Motor
U : U Series
H : H Series

S1 Device



S007K(D)-W122-⑥⑦/PCH-3M/(⑨)	2	4	4.0/ 4.8	1.4 ~ 4.2	0.8 ~ 1.4	5/7	H / U	4000
	3	5	5.6/ 6.4	1.4 ~ 4.2	0.8 ~ 1.4	5/7	H / U	4000

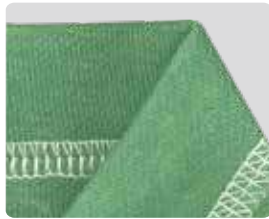

PCH-3M [三合一] 一般平縫 / 下擺車縫 / 拷克倒骨蓋縫

三合一 平縫 · 折下擺 · 倒骨 · 更換作業組裝方便 · 多樣化功能 · 提供生產廠商高效率低成本。

**PCH-3M [3 IN 1] :
GENERAL SEAMING/BOTTOM HEMMING/COVERING
STITCH (Fold-down type)**

3-in-1 model for multifunctional and efficient production with lower cost.

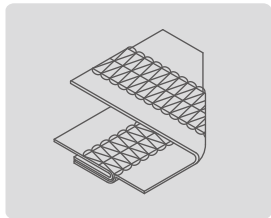

選購配件 OPTIONAL DEVICE

UTT, UTU, UTX, UTY, CMR, SAR/UTT, SAR/UTU

S2 Device



S007K(D)-W322-⑥⑦/PCE/(⑨)	2	4	4.0/ 4.8	1.4 ~ 4.2	0.8 ~ 1.4	5/7	H / U	4000
	3	5	5.6/ 6.4	1.4 ~ 4.2	0.8 ~ 1.4	5/7	H / U	4000

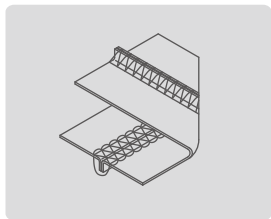

拷克立骨蓋縫

適宜中厚布料，經三線拷克車縫後再包縫，用於運動服、汗衫等領口、下擺、袖管等之拷邊車縫後加以包縫，可增加服飾之美觀及車縫之牢固，利用導布片及壓具上之壓刀導縫，可避免車縫時彎曲不直

OVERLOCK-SEAM COVERING (Flating Type)

Bulging seam covering for medium fabric after 3 thread plain seaming, suitable for neck openings, sleeve, cuff or bottom of sportswears, T-shirts, etc... With fabric guide and special presser foot, making sewing easy and more efficient.

選購配件 OPTIONAL DEVICE

UTT, UTU, UTX, UTY, SAR/UTT, SAR/UTU, CMR

規格 SPECIFICATIONS S007KD - W121 - 2 40 /FFT/DSKU

規格索引，詳細請參考P.65 Specification index, please refer to P.65

- ① 機種別 Mode ④ 功能 Function ⑦ 針距 Needle gauge ⑨ 馬達 Motor
- ② 系列 Series ⑤ 針板舌片 Needle Plate Finger ⑧ 配件 Device U : U Series
- ③ 網線方式 Covering Types ⑥ 針數 Needle Numbers H : H Series

S3 Device	⑥		⑦		⑧		⑨		S.P.M. (Max)
	針	板	mm	mm	mm	mm	mm	mm	
S007KD-W121-⑥⑦/FFT/⑨	2	4	4.0/4.8	1.4 ~ 4.2	0.8 ~ 1.4	1~5.5	5	H / U	4000
	3	5	5.6/6.4	1.4 ~ 4.2	0.8 ~ 1.4	1~5.5	5	H / U	4000
S007KD-W122-⑥⑦/FFT/⑨	2	4	4.0/4.8	1.4 ~ 4.2	0.8 ~ 1.4	1~5.5	5	H / U	4000
	3	5	5.6/6.4	1.4 ~ 4.2	0.8 ~ 1.4	1~5.5	5	H / U	4000
S007KD-W131-⑥⑦/FFT/⑨	2	4	4.0/4.8	1.4 ~ 4.2	0.8 ~ 1.4	1~5.5	5	H / U	4000
	3	5	5.6/6.4	1.4 ~ 4.2	0.8 ~ 1.4	1~5.5	5	H / U	4000
S007KD-W132-⑥⑦/FFT/⑨	2	4	4.0/4.8	1.4 ~ 4.2	0.8 ~ 1.4	1~5.5	5	H / U	4000
	3	5	5.6/6.4	1.4 ~ 4.2	0.8 ~ 1.4	1~5.5	5	H / U	4000



FFT 上送布功能

專利優化前後移動送具之結構設計，有效送布行程大，車縫送布更穩定

FFT TOP FEEDING FUNCTION

Back and forth moving feed dog is designed by patent and improved mechanism. The effective feeding stroke is bigger, and fabric feeding is more stable.

選購配件 OPTIONAL DEVICE
UTT , UTX

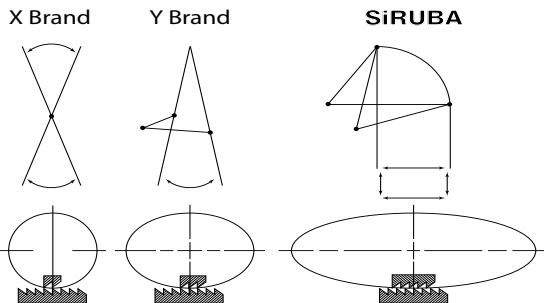

規格 SPECIFICATIONS S007KD-U173-100/SAR/RF/UTT/DSKU

規格索引，詳細請參考P.65 Specification index, please refer to P.65

- ① 機種別 Mode
 - ② 系列 Series
 - ③ 網線方式 Covering Types
 - ④ 功能 Function
 - ⑤ 針板舌片 Needle Plate Finger
 - ⑥ 針數 Needle Numbers
 - ⑦ 針距 Needle gauge
 - ⑧ 配件 Device
 - ⑨ 馬達 Motor
U : U Series
H : H Series
- *UTT 請參考 Please refer to P.113

S4 Device



S007KD-U173-100/SAR/RF/UTT/⑨	1	2	-	1.4 ~ 4.2	0.8 ~ 1.4	5/7	H / U	4000
------------------------------	---	---	---	-----------	-----------	-----	-------	------



S007KD-U173-100/SAR/RF/UTT/⑨

單針鏈縫牛仔褲轆腳機

針對彈性牛仔布料的車縫所開發的規格，配備專用的氣動式轆腳喇叭，因為具有差動送布功能，可以車縫出美觀平整的效果

- 標配:氣動式自動切線
氣動抬壓腳
直驅伺服馬達
結束密縫

SINGLE NEEDLE CHAINSTITCH JEANS BOTTOM HEMMING MACHINE

Special gauge for elastic denim fabric, and equipped with pneumatic hemming folder. Because of the function of differential feeding, the sewing quality is nice and perfectly flat.

- Standard Equipment: Pneumatic thread trimmer
Pneumatic presser foot lifter
Direct-drive servo motor
Condensed stitching device



S5 Device



S007KD-W812A-356/SRL/UTT/⑨	3	5	5.6	1.4 ~ 4.2	0.8 ~ 1.4	5/7	H / U	4000
----------------------------	---	---	-----	-----------	-----------	-----	-------	------



S007KD-W812A-356/SRL/UTT/⑨

左切刀修布下擺車縫

左切刀修布邊/下擺車縫工程適用於小筒型繙縫車

BOTTOM HEMMING WITH LEFT SIDE FABRIC TRIMMER

Left edge trimmer designed for small cylinder machine with auto thread trimmer function.



F007K/KD SERIES FEATURES

全新人體工學，圓弧流線時尚的外型設計，使用方便順手，賞心悅目
Brand new design of fashionable and smooth appearance, easy to sew.



上夾線裝置

出刀迅速精準·夾線穩定

Upper Thread Holder

Newly designed auto trimmer trims precisely and stably.



內縮式床台

縫製物更靠近機針·車縫定位精準·車縫時更加順暢就手

The Recessed Machine Bed

The sewing material is closer to the needle and the sewing is precise, which makes sewing operation easier and smoother.



拷克骨車縫附調整式進布誘導器·活動式壓腳·車縫適用性更廣

Cover seaming with adjustable folder, flexible presser foot, accommodate wider range of sewing items.



自動切線系列新設計氣/電動上下切刀組

出刀迅速穩定精準·切線俐落·輕順低噪音調整容易

Auto trimmer with newly designed pneumatic / electric trimming system

trims precisely and stably, lower sound and easy to adjust.



規格 SPECIFICATIONS F007KD - W121 - 2 40 /FHA/DFKU

規格索引，詳細請參考P.65 Specification index, please refer to P.65

- ① 機種別 Mode
- ② 系列 Series
- ③ 網線方式 Covering Types
- ④ 功能 Function
- ⑤ 針板舌片 Needle Plate Finger
- ⑥ 針數 Needle Numbers
- ⑦ 針距 Needle gauge
- ⑧ 配件 Device
- ⑨ 馬達 Motor
U : U Series
H : H Series

F1 Device

	⑥		⑦	⑧	⑨	S.P.M. (Max)		
F007K(D)-W121-⑥⑦/FHA/(⑨)	2	4	4.0/4.8	1.6 ~ 4.2	0.5 ~ 1.3	5	H / U	6000
	3	5	5.6/6.4	1.6 ~ 4.2	0.5 ~ 1.3	5	H / U	6000
F007K(D)-W122-⑥⑦/FHA/(⑨)	2	4	4.0/4.8	1.6 ~ 4.2	0.5 ~ 1.3	5	H / U	6000
	3	5	5.6/6.4	1.6 ~ 4.2	0.5 ~ 1.3	5	H / U	6000
F007K(D)-W123-⑥⑦/FHA/(⑨)	2	4	4.0/4.8	1.6 ~ 4.2	0.5 ~ 1.3	5/7	H / U	6000
	3	5	5.6/6.4	1.6 ~ 4.2	0.5 ~ 1.3	5/7	H / U	6000
F007K(D)-W162-⑥⑦/FHA/(⑨)	3	5	5.6/6.4	1.6 ~ 4.2	0.5 ~ 1.3	5/7	H / U	6000
F007K(D)-W162H-⑥⑦/FHA/(⑨)	3	5	5.6/6.4	6	0.5 ~ 1.3	5/7	H / U	6000

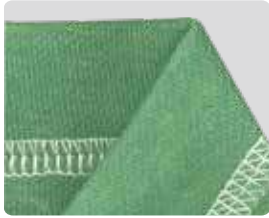
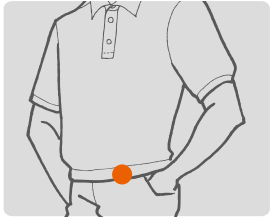

一般平縫 / 下擺車縫

本機型為雙面飾繃縫筒車之基本機型，可裝配附件進行多種功能車縫
例如：內衣褲、運動衫接縫及下擺車縫(附可調式下擺車縫組)

GENERAL SEAMING / BOTTOM HEMMING

Basic model of interlock stitch machine with double side cover-stitching. It is available for various sewing by optional devices. Such as plain seaming and bottom hemming for underwears, sportswears, etc... (equipped with adjustable hemming set)

- | | | |
|----------------|-----------------|--|
| W121 : | 薄布料 | Light material |
| W122 : | 中厚布料 | Medium material |
| W123 : | 厚布料 | Heavy material |
| W162 : | 高行程 | High needle bar stroke |
| W162H : | 高行程
大針距(6mm) | High needle bar stroke
Long stitch length (6mm) |

選購配件 OPTIONAL DEVICE
UTG , UTH , UTJ , UTK , FL

規格

SPECIFICATIONS

F007KD - W222 - 2 40 /FQ/DFKU

規格索引，詳細請參考P.65 Specification index, please refer to P.65

- ① 機種別 Mode
- ② 系列 Series
- ③ 網線方式 Covering Types
- ④ 功能 Function
- ⑤ 針板舌片 Needle Plate Finger
- ⑥ 針數 Needle Numbers
- ⑦ 針距 Needle gauge
- ⑧ 配件 Device
- ⑨ 馬達 Motor
U : U Series
H : H Series

F2 Device



F007K(D)-W222-⑥⑦/FQ/(⑨)	2	4	4.0/4.8	1.6 ~ 4.2	0.5 ~ 1.3	5	H / U	6000
	3	5	5.6/6.4	1.6 ~ 4.2	0.5 ~ 1.3	5	H / U	6000
F007K(D)-W222-⑥⑦/FFD/(⑨)	2	4	4.0/4.8	1.6 ~ 4.2	0.5 ~ 1.3	5	H / U	6000
	3	5	5.6/6.4	1.6 ~ 4.2	0.5 ~ 1.3	5	H / U	6000
F007K(D)-W222-⑥⑦/FFP/(⑨)	2	4	4.0/4.8	1.6 ~ 4.2	0.5 ~ 1.3	5	H / U	6000
	3	5	5.6/6.4	1.6 ~ 4.2	0.5 ~ 1.3	5	H / U	6000



F007K-W222-356/FQ/FEC



F007K-W222-356/FFD



F007K-W222-356/FFP

FQ:上帶滾邊車縫

適用於 T 恤、內衣褲之領口、褲管口等上帶滾邊之車縫工程，可加附電動(FEC)或氣動式(FAC)長切刀式切布條裝置，能將滾邊布條切斷，節省布條之用料增加車縫效率

FQ:TAPE BINDING

For tape binding on openings of leg or neck of underwears, T-shirts, etc... Also can attach electric(FEC) or pneumatic(FAC) tape cutter to save tape and increase sewing efficiency.



◀ 以上機型可加裝
FNC, FSC:
電眼型後切刀附直驅馬達

Optional device for the above models
FNC, FSC:
Sensor type rear cutter with direct-drive servo motor

FFD / FFP:上帶滾邊車縫包覆鬆緊帶

上送帶裝置控制鬆緊帶張力，加上膝動控制鬆緊帶之左右移動，能有效讓鬆緊帶前後段與衣身車縫固定，適用於內褲之褲頭、褲腳之滾邊加鬆緊帶之車縫工程

FFD: 齒輪箱型精準張力控制

FFP: 彈簧片型簡易張力控制

FFD / FFP:TAPE BINDING WITH ELASTIC BAND

Top feeding device controls the elastic band's tension. Elastic band right-left position controller (by knee-pushing) sets the materials joining at the beginning and ending of waistband, leg opening of briefs...etc.

FFD: Gearbox type for accurate tension control

FFP: Spring type for simple tension control

選購配件 OPTIONAL DEVICE

FA, LF-A, FAC, FEC, LS-A

規格 SPECIFICATIONS F007K - W222 - 2 40 /FSM

規格索引，詳細請參考P.65 Specification index, please refer to P.65

- ① 機種別 Mode ④ 功能 Function ⑦ 針距 Needle gauge
- ② 系列 Series ⑤ 針板舌片 Needle Plate Finger ⑧ 配件 Device
- ③ 網線方式 Covering Types ⑥ 針數 Needle Numbers

F3 Device

	⑥	⑧	⑦	⑤	④	③	②
F007K-W222-240-4/FSM	2	8	4.0	1.6 ~ 4.2	0.5 ~ 1.3	5	2500
F007K-W222-248-4/FSM	2	8	4.8	1.6 ~ 4.2	0.5 ~ 1.3	5	2500
F007K-W222-364-4/FSM	3	9	6.4	1.6 ~ 4.2	0.5 ~ 1.3	5	2500



F007K-W222-356/FSM

花飾滾邊車縫

用於T恤衫、襯衫等領口、下擺、袖口等花飾滾邊車縫。附有四組花飾凸輪可變化成數百種車縫花樣

ORNAMENTAL TAPE BINDING

Suitable for ornamental tape binding of neck band, bottom or cuff of T-shirts, shirts, etc...



選購配件 OPTIONAL DEVICE
FA

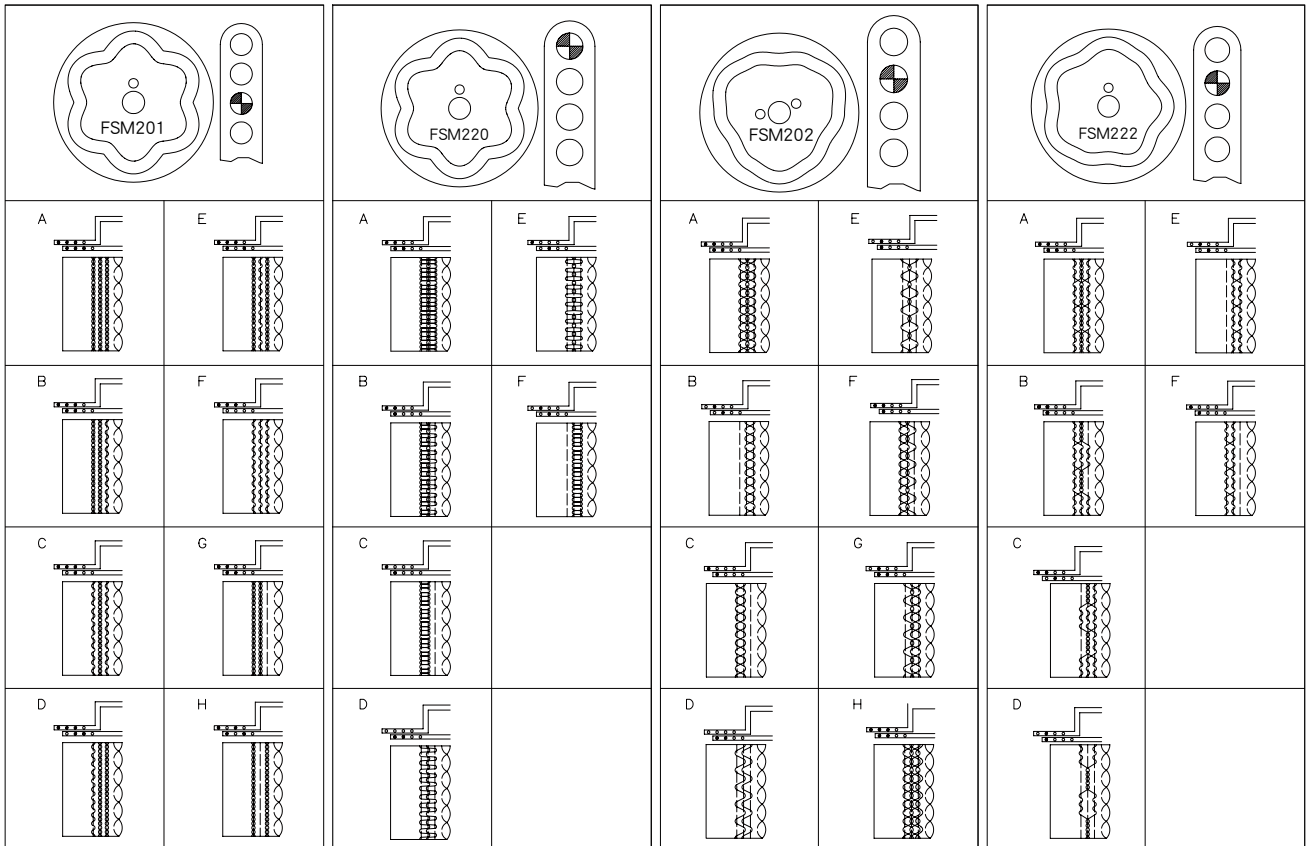

規格

SPECIFICATIONS

F007KD - W322 - 3 56 /FDC/DFKU

規格索引，詳細請參考P.65 Specification index, please refer to P.65

- ① 機種別 Mode
- ② 系列 Series
- ③ 網線方式 Covering Types
- ④ 功能 Function
- ⑤ 針板舌片 Needle Plate Finger
- ⑥ 針數 Needle Numbers
- ⑦ 針距 Needle gauge
- ⑧ 配件 Device
- ⑨ 馬達 Motor
U : U Series
H : H Series

F4 Device

	⑥	⑦	⑦	⑦	⑦	⑦	⑨	⑨
F007K(D)-W322-⑥⑦/FDC/(⑨)	3	5	5.6/ 6.4	1.6 ~ 4.2	0.5 ~ 1.3	5	H / U	6000
F007K(D)-W322-⑥⑦/FDE/(⑨)	3	5	5.6/ 6.4	1.6 ~ 4.2	0.5 ~ 1.3	5	H / U	6000



F007K-W222-356/FDC



F007KD-W322-356/FDE/UTJ/⑨

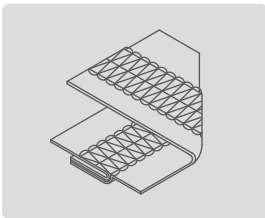

FDC



FDC

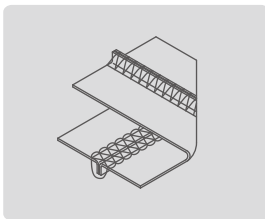

FDE

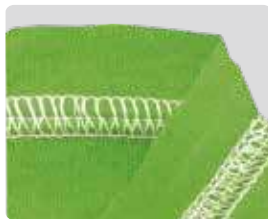

FDE

拷克倒骨蓋縫

FDC 倒骨型：適用於4線包縫之蓋縫

FDE 立骨型：適用於3線包縫之蓋縫

配件盒另附有FDC倒骨規格之牛角 (導布片)

OVERLOCK-SEAM COVERING STITCH

FDC Fold-down type : For 4-thread overlock-seam covering stitch.

FDE Flattening type : For 3-thread overlock-seam covering stitch, and an extra guide of overlock-seam (FDC specification, fold-down type) is included in the accessory box.

選購配件 OPTIONAL DEVICE

UTG , UTH , UTJ , UTK

規格 SPECIFICATIONS F007K - W522 - 2 40 /FR /FFC

規格索引，詳細請參考P.65 Specification index, please refer to P.65

- ① 機種別 Mode ④ 功能 Function ⑦ 針距 Needle gauge
- ② 系列 Series ⑤ 針板舌片 Needle Plate Finger ⑧ 配件 Device
- ③ 網線方式 Covering Types ⑥ 針數 Needle Numbers

F5 Device

	⑥	④	⑦	⑤	③	⑧
F007K-W522-⑥⑦/FR/FFC	2	4	4.0/ 4.8	1.6 ~ 4.2	0.5 ~ 1.3	4500
	3	5	5.6/ 6.4	1.6 ~ 4.2	0.5 ~ 1.3	4500
F007K-W522-⑥⑦/FR/FE	2	4	4.0/ 4.8	1.6 ~ 4.2	0.5 ~ 1.3	4500
	3	5	5.6/ 6.4	1.6 ~ 4.2	0.5 ~ 1.3	4500
F007K-W522-⑥⑦/FR/SMK	2	4	4.0/ 4.8	1.6 ~ 4.2	0.5 ~ 1.3	4500
	3	5	5.6/ 6.4	1.6 ~ 4.2	0.5 ~ 1.3	4500
F007K-W522-⑥⑦/FR/STC	2	4	4.0/ 4.8	1.6 ~ 4.2	0.5 ~ 1.3	4500
	3	5	5.6/ 6.4	1.6 ~ 4.2	0.5 ~ 1.3	4500



F007K-W522-240/FR/FE/FAC



SMK



STC

鬆緊帶 / 蕾絲鬆緊帶上帶車縫附右切刀

由上送帶裝置，控制長度與張力，附右切刀修布裝置，能於車縫前將布修齊，更能提高車縫品質，如女用內衣褲之鬆緊帶或蕾絲鬆緊帶車縫

- FFC:** 機械式送帶
- FE:** 簡易電子式送帶
- SMK:** SMK1-C-01 附定位器，適合簡易伺服或離合器馬達
SMK1-C-02 以中繼線，連接伺服馬達張力控制式送帶
- STC:** 張力控制式送帶
STC1-U-01 附定位器，適合簡易伺服或離合器馬達
STC1-U-02 以中繼線，連接伺服馬達張力控制式送帶

ELASTIC / LACE ATTACHING WITH RIGHT FABRIC TRIMMER

Top feeding devices ensure even length and tension controlled by electric digital controller, with right side fabric trimmer for elastic or lace attaching smoothly and properly on women's underwears.

- FFC:** Mechanic type tape feeding.
- FE:** Simple electric type tape feeding.
- SMK:** Electric metering type tape feeding
SMK1-C-01 with synchronizer for simple servo motor or clutch motor
SMK1-C-02 Connected to servo motor by encoder cable
- STC:** Tension sensor type tape feeding
STC1-U-01 with synchronizer for simple servo motor or clutch motor
STC1-U-02 Connected to servo motor by encoder cable

選購配件 OPTIONAL DEVICE
FAC, FEC, LF-A, LS-A

規格

SPECIFICATIONS

F007K - W522 - 2 40 /FR /FQS

規格索引，詳細請參考P.65 Specification index, please refer to P.65

- ① 機種別 Mode
- ② 系列 Series
- ③ 網線方式 Covering Types
- ④ 功能 Function
- ⑤ 針板舌片 Needle Plate Finger
- ⑥ 針數 Needle Numbers
- ⑦ 針距 Needle gauge
- ⑧ 配件 Device

F6 Device

F007K-W522-2⑦/FR/FQS	2	4	3.2/ 4.0	1.6 ~ 4.2	0.5 ~ 1.3	5	4500



F007K-W522-240/FR/FQS

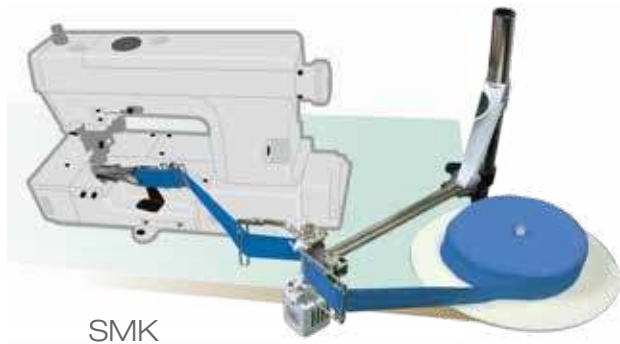

SMK

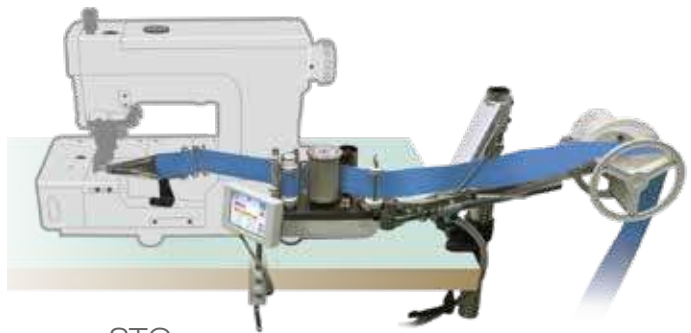

STC

細滾邊車縫 (右切刀機型附側送小喇)

本機型適用於女性內褲或丁字褲之細滾邊車縫。在滾邊之前先經右切刀修布，避免發生爆縫問題，可搭配以下送帶裝置

SMK: 電子計數式送帶

- SMK1-E-01 附定位器，適合簡易伺服或離合器馬達
- SMK1-E-02 以中繼線，連接伺服馬達張力控制式送帶

STC: 張力控制式送帶

- STC1-S-01 附定位器，適合簡易伺服或離合器馬達
- STC1-S-02 以中繼線，連接伺服馬達

FINE TAPE BINDING (RIGHT TRIMMER MODEL WITH SMALL BINDER)

This machine is applicable for fine tape binding of women's underwear or T-string. Before tape binding, the fabric edge is trimmed by the right trimmer. This solves the problem of bad binding, which the tape is not sewn on the fabric. The below tape feeding devices are applicable.

SMK: Electric metering type tape feeding

- SMK1-E-01 with synchronizer for simple servo motor or clutch motor
- SMK1-E-02 Connected to servo motor by encoder cable

STC: Tension sensor type tape feeding

- STC1-S-01 with synchronizer for simple servo motor or clutch motor
- STC1-S-02 Connected to servo motor by encoder cable

選購配件 OPTIONAL DEVICE

FAC, FEC, LF-A, LS-A, TUA

規格 SPECIFICATIONS F007KD - U122 - 2 32 /FP /DFKU

規格索引，詳細請參考P.65 Specification index, please refer to P.65

- ① 機種別 Mode
- ② 系列 Series
- ③ 網線方式 Covering Types
- ④ 功能 Function
- ⑤ 針板舌片 Needle Plate Finger
- ⑥ 針數 Needle Numbers
- ⑦ 針距 Needle gauge
- ⑧ 配件 Device
- ⑨ 馬達 Motor
U : U Series
H : H Series

F7 Device

F007K(D)-U122-232/FP/(⑨)	2	3	3.2	1.6 ~ 4.2	0.5 ~ 1.3	7	H / U	6000



F007K-U122-232/FP

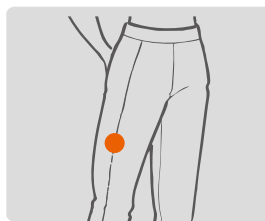

折線條車縫

本機種適用於運動服、牛仔或其他服飾之凸面折線條車縫，車縫時可於折線條內另加縫線繩，以增加凸線條之立體感和裝飾效果

PINTUCK SEAMING

To sew a decorative convex stripe on sportswears, jeans or other clothes, can also add extra stripe inside convex to increase the effects of convexity and decoration.

F8 Device

F007K(D)-U613-2⑦/FBP/(⑨)	2	3	5.6/6.4	1.6 ~ 4.2	0.5 ~ 1.3	7	H / U	6000



F007K-U613-256/FBP

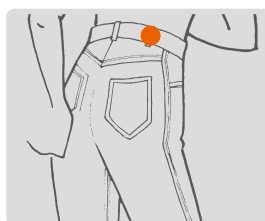

褲耳車縫

利用已裁好之等寬布條連續快速製作褲耳

BELT-LOOP SEAMING

Mass production for belt loop by using stripped tape.

選購配件 OPTIONAL DEVICE
LF-A, LS-A

規格

SPECIFICATIONS

F007KD -U712A -264 /FSP/DFKU

規格索引，詳細請參考P.65 Specification index, please refer to P.65

- ① 機種別 Mode
- ② 系列 Series
- ③ 網線方式 Covering Types
- ④ 功能 Function
- ⑤ 針板舌片 Needle Plate Finger
- * U712A: finished tape width 12mm
- ⑥ 針數 Needle Numbers
- ⑦ 針距 Needle gauge
- ⑧ 配件 Device
- ⑨ 馬達 Motor
- U : U Series
- H : H Series

F9 Device

F007K(D)-U712(A)-264/FSP/(⑨)	2	4	6.4	1.6 ~ 4.2	0.5 ~ 1.3	5	H / U	6000
F007K(D)-U712-496/FSS/(⑨)	4	6	9.6	1.6 ~ 4.2	0.5 ~ 1.3	5	H / U	6000
F007K(D)-U712-4111/FSS/(⑨)	4	6	11.1	1.6 ~ 4.2	0.5 ~ 1.3	5	H / U	6000



F007K-U712-264/FSP

選購配件 OPTIONAL DEVICE

LF-A, LS-A

布條車縫 (雙針雙勾)

本機系將拷克後之拷克骨縫上布條以補強及增加美觀之用，如男內褲、休閒褲等之車縫

U712: 成品寬度10mm

U712A: 成品寬度12mm

TAPE ATTACHING (TWO NEEDLE, TWO LOOPER)

This machine is specially for tape binding on cross seaming of men's briefs or sportswears to strengthen plain seam and for ornamental purpose.

U712: finished tape width 10mm

U712A: finished tape width 12mm

布條車縫 (四針雙勾)

本機系將拷克後之拷克骨縫上布條以補強及增加美觀之用，如男內褲、休閒褲等之車縫

TAPE ATTACHING (FOUR NEEDLE, TWO LOOPER)

This machine is specially for tape binding on cross seaming of men's briefs or sportswears to strengthen plain seam and for ornamental purpose.

F10 Device

F007K(D)-U712-264/FSR/(⑨)	2	4	6.4	1.6 ~ 4.2	0.5 ~ 1.3	5	H / U	6000



F007K-U712-264/FSR

捲疊縫

本機種設計特殊之左右齒差動方式，能使捲疊縫縫紉更順暢車縫後左右二片布均一無長短之虞，適用於西褲、休閒褲、牛仔褲薄至厚布料等之捲邊疊縫

LAP SEAMING

Differential ratio of left and right feed dog can be adjusted separately for lap seaming to ensure symmetrical length to both left and right fabric. Applicable to trousers, casual pants and jeans, etc...

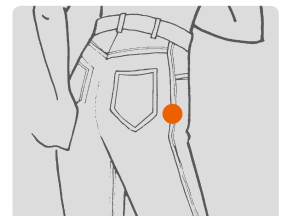

規格

SPECIFICATIONS

F007KD - W722 - 3 88 /FY /DFKU

規格索引，詳細請參考P.65 Specification index, please refer to P.65

- ① 機種別 Mode
- ② 系列 Series
- ③ 網線方式 Covering Types
- ④ 功能 Function
- ⑤ 針板舌片 Needle Plate Finger
- ⑥ 針數 Needle Numbers
- ⑦ 針距 Needle gauge
- ⑧ 配件 Device
- ⑨ 馬達 Motor
U : U Series
H : H Series

F11 Device



F007K(D)-W722-388/FY/(⑨)	3	7	8.8	1.6 ~ 4.2	0.5 ~ 1.3	5	H / U	6000
--------------------------	---	---	-----	-----------	-----------	---	-------	------



F007K-W722-388/FY

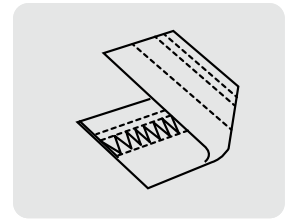
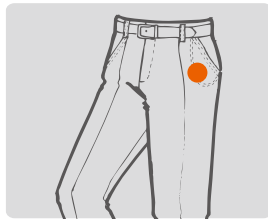

褲袋裡車縫

本機為三針三勾針一上叉，可同時縫合褲袋內裡與表布並強化車縫處之牢固，增加美觀提高效率，適用於西褲、工作褲等

POCKET LINING SEAMING

This is a 3 needles 3 loopers 1 spreader machine, and special for seaming the shell fabric and lining of pocket in trousers or work pants in simple operation to increase sewing quality and efficiency.

F12 Device



F007K(D)-W922-456/FW/(⑨)	4	6	5.6	1.6 ~ 4.2	0.5 ~ 1.3	5	H / U	6000
F007K(D)-W922-460/FW/(⑨)	4	6	6.0	1.6 ~ 4.2	0.5 ~ 1.3	5	H / U	6000
F007K(D)-W922-464/FW/(⑨)	4	6	6.4	1.6 ~ 4.2	0.5 ~ 1.3	5	H / U	6000



F007K-W922-456/FW

四針六線搭接縫車縫

適用於一般內衣褲二片布接縫處之接縫和補強，附有專屬之導邊，可使二片布順暢縫合

FOUR-NEEDLE FLAT SEAMING

For flat seaming 2 pieces of fabric. Equipped with fabric guide for easy operation.

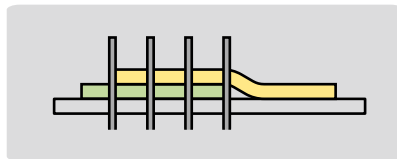

選購配件 OPTIONAL DEVICE
UTH, UTK

FW- 4	四針，無假針，適用上網線切線刀 4 needles Without retainer, applicable to upper thread trimmer
FW- 4A	配特殊針板 E1838P，適合車縫運動鞋裝飾線 With special needle plate E1838P, applicable to shoe decoration
FW- 5	四針，有假針，不適用上網線切線刀 4 needles with retainer, not applicable to upper thread trimmer

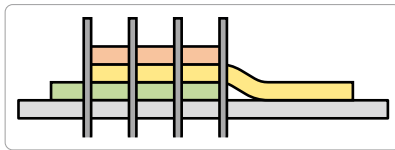

FWP

附喇叭 (B417R) 與導帶架

With folder (B417R) and tape guide.

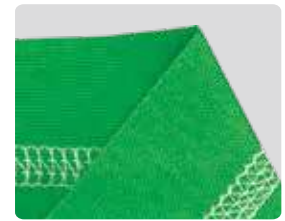
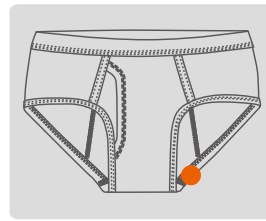

FW-4A

規格 SPECIFICATIONS F007KD - W121 - 2 40/ FFT/ FHA/ DFKU

規格索引，詳細請參考P65 Specification index, please refer to P65

- ① 機種別 Mode
- ④ 功能 Function
- ⑦ 針距 Needle gauge
- ⑨ 馬達 Motor
- ② 系列 Series
- ⑤ 針板舌片 Needle Plate Finger
- ⑧ 配件 Device
- U : U Series
- H : H Series
- ③ 網線方式 Covering Types
- ⑥ 針數 Needle Numbers

F13 Device

F007KD-W121-⑥⑦/FFT/FHA⑨	2	4	4.0/ 4.8	1.6 ~ 4.2	0.5 ~ 1.3	1~5.5	5	H / U	4500
	3	5	5.6/ 6.4	1.6 ~ 4.2	0.5 ~ 1.3	1~5.5	5	H / U	4500
F007KD-W122-⑥⑦/FFT/FHA⑨	2	4	4.0/ 4.8	1.6 ~ 4.2	0.5 ~ 1.3	1~5.5	5	H / U	4500
	3	5	5.6/ 6.4	1.6 ~ 4.2	0.5 ~ 1.3	1~5.5	5	H / U	4500
F007KD-W131-⑥⑦/FFT/FHA⑨	2	4	4.0/ 4.8	1.6 ~ 4.2	0.5 ~ 1.3	1~5.5	5	H / U	4500
	3	5	5.6/ 6.4	1.6 ~ 4.2	0.5 ~ 1.3	1~5.5	5	H / U	4500
F007KD-W132-⑥⑦/FFT/FHA⑨	2	4	4.0/ 4.8	1.6 ~ 4.2	0.5 ~ 1.3	1~5.5	5	H / U	4500
	3	5	5.6/ 6.4	1.6 ~ 4.2	0.5 ~ 1.3	1~5.5	5	H / U	4500



FFT 上送布功能

專利優化前後移動送具之結構設計，有效送布行程大，車縫送布更穩定

FFT TOP FEEDING FUNCTION

Back and forth moving feed dog is designed by patent and improved mechanism. The effective feeding stroke is bigger, and fabric feeding is more stable.

選購配件 OPTIONAL DEVICE
UTG, UTJ

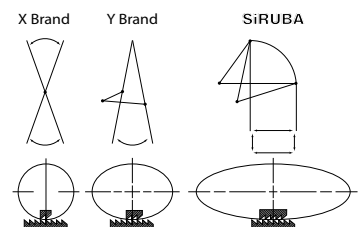

DEVICE



CAR

氣動式密縫裝置 Pneumatic Condense Stitching Device (CAR/SAR)
膝動式密縫裝置 Manual Condense Stitching Device (CMR)

藉由縮短送具行程，在車縫起始或結束時進行密縫的功能，確保縫線不易脫落，提高車縫品質，基本車為腳踏板控制，電動和氣動控制為選配，本配件需更換專用規格組
 By reducing the strokes of feed dog, at the beginning and the end of sewing, condense stitching reinforces the stitches. This enhances the sewing sturdiness and quality. Basic model is controlled by pedal. Electric and pneumatic controls are optional. Exclusive gauge sets is required.



SAR



CMR

Applicable Model	CAR (Pneumatic)	SAR (Pneumatic)	CMR (Manual)
C007KP	V	X	V
S007K S007K/DS□	X	V	V

可自行組裝 self-installation : YES



CAF

氣動式持壓控制裝置 Pneumatic Presser Foot Pressure Regulator

1. 氣動式持壓控制裝置，運用氣動讓壓腳壓力保持在均勻且最低限度的控制下，穩定持壓下無論彈性、極薄布料都可即時調整成適合的壓腳壓力。
2. 氣壓調節閥簡單操作，即時目測當下壓腳壓力並彈性調整，縮短調整時間、提高生產效率。

*註：1. 需有空壓設備 2. 搭配伺服馬達使用

1. Pneumatic Presser Foot Pressure Regulator uses the pneumatic device to keep the presser foot pressure under uniform and minimal control. It can be adjusted to the suitable presser foot pressure in real time regardless of the elasticity or extremely thin fabric under stable holding pressure.

2. The pressure regulating valve is easy to operate, instantly visually detect the current pressure of the presser foot and adjust it flexibly, shortening the adjustment time and improving production efficiency.

*Note: 1. Air pressure equipment is required 2. Used with servo motor

可自行組裝 self-installation : NO

適用機型 applicable model : 全系列繡縫機 All Interlock Series



CC

拷克倒骨蓋縫裝置 Overlock- Seam Covering (Fold-down Type)

1. 適中厚至厚布料經四線拷克車包縫後之飾縫
 2. 對於運動服、領子、衣襟、袖管之拷邊車縫後加以單面或雙面裝飾環縫，可增加服飾之美觀及車縫之牢固。利用導布片及壓具上之壓刀導縫，可避免車縫時彎曲不直
1. Overturned seam covering for medium to heavy fabric after 4 thread plain seaming.
 2. Suitable for neck openings, sleeve, cuff or bottom of sportswears, T-shirts, etc... With fabric guide and special presser foot making sewing easy and more efficient.

可自行組裝 self-installation : YES

適用機型 applicable model : C007KP-W322, C007L-W322

**CE****拷克倒 / 立骨蓋縫裝置
Overlock-Seam Covering (Fold-down / Flattening Type)**

1. 適中厚布料經三線拷克車包縫後之飾縫
2. 對於運動服·領子·衣襟·袖管之拷邊車縫後加以單面或雙面裝飾環縫·可增加服飾之美觀及車縫之牢固。利用導布片及壓具上之壓刀導縫·可避免車縫彎曲不直

1. Bulging seam covering for medium fabric after 3 thread plain seaming.
2. Suitable for neck openings, sleeve, cuff or bottom of sportswears, T-shirts, etc... With fabric guide and special presser foot making sewing easy and more efficient.

可自行組裝 self-installation : YES

適用機型 applicable model : C007KP-W322, C007L-W322, C007L-U322

**CFC****鬆緊帶折縫 Elastic Hemming**

經由齒輪控制箱之控制·能有效控制鬆緊帶之鬆緊度·配合三折或二折折布喇叭及鬆緊帶壓縫·可精確完美的進行短褲·內褲等褲腳及褲頭之鬆緊帶折縫

Elastic hemming evenly length and elasticity is controlled by gear box. Great for seam covering with two or three plies hemming binder on elastic for waistband or leg opening of briefs and shorts's, etc...

可自行組裝 self-installation : NO

適用機型 applicable model : C007KP-W542

**CH****下擺車縫 Hemming**

T恤·內衣及兒童服飾之下擺及袖口之車縫·可隨需要調整下擺飾縫組寬度·操作簡單快捷
Suitable for the bottom hemming of T-shirts, underwears, cuff of children's garments, etc...
Able to adjust the width of hemming set to fit demands, easy operation.

可自行組裝 self-installation : YES

適用機型 applicable model : C007KP-W121, C007KP-W122, C007KP-W123,
C007KP-W162 , C007L-W122, C007L-W162, C007L-U122**CHP****[二合一]氣動式下擺車縫 / 環型鬆緊帶折縫附左切刀修布邊功能
[2 IN 1]Pneumatic Hemming / Tubular Elastic Tape hemming With Left Edge Trimmer**

氣動式布料導邊器能將布料及鬆緊帶順暢的捲折·此外左切刀切齊後再進行縫紉·可增加包縫工程之品質與效率·適用於男內褲·運動褲等褲頭鬆緊帶包縫

With pneumatic driving folder to fold fabric and insert elastic smoothly, left hand side fabric trimming before hemming increases sewing quality & efficiency. For hemming sleeve opening and bottom of underwears, T-shirts, or sportswears, etc...

**CY**

可自行組裝 self-installation : NO

適用機型 applicable model : C007KP-W822



CL

後拉引滾輪 Rear Puller

1. 可拉車縫過後之布及鬆緊帶，使其不會產生車縫過後擠壓之毛病，以達車縫平順快速之效果
2. 本輔助件同時內附齒狀滾輪CL (CL19+ CL53) 與平面滾輪CLA (CL20+CL52)，供客戶依車縫布料之不同來選擇使用。一般布料用平面滾輪，但另車縫鬆緊帶或蕾絲鬆緊帶時，請用齒狀滾輪
3. 為能正確之校縫，機器裝配時會按實際需要裝齒狀滾輪與平面滾輪，但於配件盒附上另一組齒輪



CLA

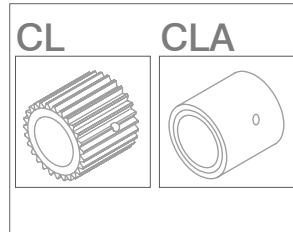

1. Pulls the fabric and elastic after sewing and makes sewing fast, flat and smooth without wrinkles.
2. The attachment includes both CL(CL19+CL53) and CLA(CL20+CL52). CLA is flat type for normal material, and CL is serrated type for elastic or lace, etc...
3. For fine-tuning purpose, the machine will be equipped with one rear puller depending on actual demand, the other one will be placed in the accessory box.

可自行組裝 self-installation : NO

適用機型 applicable model : C007KP



CQ

上帶滾邊車縫 Tape Binding

1. T 恤、內衣褲、兒童服飾等之領口、袖口和褲管口之包邊
2. 訂購內附CQ之機器內附FG組，但個別購買CQ裝置時則不另附FG組
3. 包邊喇叭之標準規格為入布寬度1-3/8"，出布時成三折，寬度為1/2"。若需訂購標準品以外之尺寸，請於訂購時特別註明，但交期及費用另計
4. 本輔助件有三種訂購方式：



CQA

1. For tape binding on openings of leg or neck of underwears, T-shirts, etc...
2. If purchased machine with CQ device, FG device will also be included. If only CQ device were purchased, no FG included.
3. Binder's standard tape size is 1-3/8" wide and finished size is 1/2" wide in 3 folds. Please remark if need another size when ordering, delivery and cost will be recalculated.
4. Ways to order the device:

機型 Model	CQ	FG	CQ 規格組 CQ Gauge Set	喇叭 Binder
C007KP-W222-240/CQ	√	√	√	√
C007KP-W222-240	X	X	√	X
C007KP-W222-240/CQ-P	√	√	√	X

可自行組裝 self-installation : YES

適用機型 applicable model : C007KP-W222



CR

右切刀修布及切布裝置 Right Hand Side Trimmer

修齊右邊或右下方多餘之布料，使衣物車縫後更加整齊美觀；附加吸布屑裝置更能保持工作環境乾淨

Right hand side waste fabric trimming with waste suction device makes fabric edge aligned to seam and keeps the working area clean.

可自行組裝 self-installation : NO

適用機型 applicable model : C007KP-W522, C007KP-W532, C007L-W532, C007L-U532



CRL

左切刀修布裝置 Left Hand Side Trimmer

修齊二片布接縫之左下方多餘之布料，使衣物車縫後更加整齊美觀
Left hand side fabric trimming makes fabric edge aligned to seam.

可自行組裝 self-installation : NO

適用機型 applicable model : C007KP-W812(A), C007KP-W822, C007L-W812,
C007L-U812, C007L-W822



CW

四針六線環縫車縫裝置 Four-needle Flat Seaming

適用於一般內衣褲二片布接縫處之接縫和補強，附有專屬之導邊器，可使二片布順暢縫合
For flat seaming 2 pieces of fabrics on men's briefs, fabric guide included.

可自行組裝 self-installation : YES

適用機型 applicable model : C007KP-W922



CX

環型平織鬆緊帶包縫裝置 Pneumatic Elastic Inserting

環型平織鬆緊帶或蕾絲鬆緊帶與衣物接縫，適用於男女內褲褲腰之鬆緊帶縫合，配合右切刀修布裝置更能提高縫製品質

For tubular elastic or lace waistband attaching on men's or women's briefs, with right hand side fabric trimming to increase sewing quality and efficiency.

可自行組裝 self-installation : YES

適用機型 applicable model : C007KP-W532, C007L-W532, C007L-U532



CZ

氣動式環型羅紋鬆緊帶包縫裝置 Pneumatic Elastic Inserting

男女用內褲之褲頭環型棉織鬆緊帶之包縫，本裝置需搭配CL及RLQ使用

Attaching tubular elastic tape onto waistband, suitable for briefs. For using this device, CL and RLQ must be equipped together.

可自行組裝 self-installation : YES

適用機型 applicable model : C007KP-W152



CZP

膝動式環型羅紋鬆緊帶包縫裝置 Manual Elastic Inserting

男女用內褲之褲頭環型棉織鬆緊帶之包縫，本裝置需搭配CL及RLQ使用

Attaching tubular elastic tape onto waistband, suitable for briefs. For using this device, CL and RLQ must be equipped together.

可自行組裝 self-installation : YES

適用機型 applicable model : C007KP-W152



FA

側向電動送帶裝置 Side Electric Tape Feeding

1. 利用電子微動開關控制布條，鬆緊帶或蕾絲之輸送長度，使上帶車縫更加平順
2. 送帶在控制箱右邊

1. With electronic switch to control the feeding length of tape, elastic, or lace to create smoother sewing.

2. Tape feeding will be on the right hand side of the control box.

可自行組裝 self-installation : YES

適用機型 applicable model : C007KP/CQ, C007KP/CQA,
F007K/FQ, F007K/FFD, F007K/FFP, F007K/FSM, F007KD/FQ,
F007KD/FFP

F□C 後切刀系列 Rear Cutter Series



FAC



FEC



FNC/FSC



FNC



FSC

	操作模式 Operation Mode	切刀驅動 Cutter Driven by	電眼 Sensor	抬壓腳 Presser foot lifter	控制器 Controller	功能 Function
FAC	膝動 Knee	氣缸 + 機械閥 (氣動) Air cylinder + mechanical Valve (Pneumatic)	/	/	/	手動切刀 Manual Cutting
FEC	膝動 Knee	電磁鐵 (電動) Solenoid (Electric)	/	/	FE201-A2 專用電控箱 Specific control box	手動切刀 Manual Cutting
FNC	自動/ 膝動 Auto/ Knee	氣缸 + 電磁閥 (氣動) Air cylinder + Solenoid (Pneumatic)	v	v	DFH608ADE-E 伺服馬達驅動 Driven by servo motor	電眼偵測布邊 (類似700QD/ECA) The sensor checks the cloth edge. (Similar to 700QD/ECA)
FSC	自動/ 膝動 Auto/ Knee	氣缸 + 電磁閥 (氣動) Air cylinder + Solenoid (Pneumatic)	v	v	DFH301NDD-E 伺服馬達驅動 附觸控面板 Driven by servo motor, with Control Panel	電眼偵測布邊·並且控制器以計數方式, 控制布帶的鬆緊度與餘留長度·適用比基尼車縫 Checking the cloth edge by sensor, and also the metering device controls the tape tension and the remained length. Applicable to bikini sewing.

可自行組裝 self-installation : NO

適用機型 applicable model : F007K/FQ, F007K/FE, F007K/SMK, F007K/STC, F007K/FR, F007K/FR/FQS,





FBP

褲耳車縫 Belt Loop Seaming

利用已裁好等寬之布條連續快速車縫褲耳

1. 一般W122機型可變換成FBP機型，只需訂購組件FBP- 256或FBP- 264，便可換成車褲耳之功能

2. 因所車縫布料不同而其所搭配之喇叭與針也會不同，訂購時請註明

Mass production for belt loop by using stripped tape.

1. Normal W122 type can be changed to FBP type with FBP-256 or FBP-264 for belt loop seaming.

2. Different size folders and needles may be required depends on different fabric. Please refer to the below table and remark when ordering.

針距 Needle Gauge	成品尺寸 Finished Good	喇叭代號 Folder No.	布料 Fabric
5.6mm	9 mm	FBP01A	男女西服 Suits for Men & Women
5.6mm	10mm	FBP01B	
6.4mm	12mm	FBP01C	牛仔 Jeans

可自行組裝 self-installation : YES

適用機型 applicable model : F007K-U613, F007KD-U613



FDC

拷克倒骨包縫裝置 Covering Seaming

1. 適中厚至厚布料經四線拷克車包縫後之飾縫

2. 對於運動服等衣物之領子、衣襟、袖管之拷邊包縫後加以單面或雙面裝飾環縫，可增加服飾之美觀及車縫之牢固。利用導布片及壓具壓刀之導縫，可避免車縫彎曲不直

1. Overturned seam covering for medium to heavy fabric after 4 thread plain seaming.

2. Suitable for neck openings, sleeve, cuff or bottom of sportswears, T-shirts, etc... With fabric guide and special presser foot making sewing easy and more efficient.

可自行組裝 self-installation : YES

適用機型 applicable model : F007K-W322, F007KD-W322



FDE

拷克立骨包縫裝置 Covering Seaming

1. 適中厚至厚布料經三線拷克車包縫後之飾縫

2. 對於運動服等衣物之領子、衣襟、袖管之拷邊包縫後加以單面或雙面裝飾環縫，可增加服飾之美觀及車縫之牢固。利用導布片及壓具壓刀之導縫，可避免車縫彎曲不直

1. Bulging seam covering for medium to heavy fabric after 3 thread plain seaming.

2. Suitable for neck openings, sleeve, cuff or bottom of sportswears, T-shirts, etc... With fabric guide and special presser foot making sewing easy and more efficient.

可自行組裝 self-installation : YES

適用機型 applicable model : F007K-W322, F007KD-W322



FE

電子式鬆緊帶控制裝置 Electric Type Elastic Feeding

1. 經由電子控制箱之數位設定，能有效控制鬆緊帶在設定好之鬆緊度輸送，以供車縫

2. 本裝置可接受鬆緊帶最大輸送寬度為2-1/2"

1. Elastic feeding ensures even length and elasticity, controlled by electronic digital control box.

2. Maximum feeding width of elastic is 2-1/2".

可自行組裝 self-installation : YES

適用機型 applicable model : F007K-W522, C007KP-W522



FFC

機械式鬆緊帶控制裝置 Mechanic Type Elastic Feeding

1. 經由機體內機械帶動可自動輸送鬆緊帶，並經由齒輪箱控制器旋轉鈕，可依照衣服尺寸，微調設定車縫鬆緊帶之鬆緊程度
 2. 本裝置可接受鬆緊帶最大輸送寬度為2-1/2"
1. Elastic feeding ensures even length and elasticity controlled by gear set.
 2. Maximum feeding width of elastic is 2-1/2".

可自行組裝 self-installation : No

適用機型 applicable model : F007K-W522, C007KP-W522



FFD

腰間或褲腳包縫控制鬆緊帶前後車縫裝置(機械式) Mechanic Type Elastic Feeding & Binding

1. 短褲及男女用內褲褲頭或褲腳之鬆緊帶包縫，利用無段變速控制器，可精確調整鬆緊帶的鬆緊程度；運用操作簡便之膝動控制系統，控制鬆緊帶前後車縫，使車縫更完美
 2. 本裝置可接受鬆緊帶最大之尺寸為1/8" 到1/4" 之寬度
1. Elastic feeding ensures even length and elasticity controlled by gear set with elastic tape side-motion controller for sewing the beginning and ending of elastic tape onto waistband, leg opening of briefs, etc...
 2. Maximum width of elastic is 1/8" to 1/4".

可自行組裝 self-installation : YES

適用機型 applicable model : F007K-W222



FFP

腰間或褲腳包縫控制鬆緊帶前後車縫裝置(彈簧式) Mechanic Type Elastic Feeding & Binding (Leaf Spring)

1. 短褲及男女用內褲褲頭或褲腳之鬆緊帶包縫，利用無段變速控制器，可精確調整鬆緊帶的鬆緊程度；運用操作簡便之膝動控制系統，控制鬆緊帶前後車縫，使車縫更完美
 2. 本裝置可接受鬆緊帶最大之尺寸為1/8" 到1/4" 之寬度
1. Elastic feeding ensures even length and elasticity controlled by leaf spring with elastic tape side-motion controller for sewing the beginning and ending of elastic tape onto waistband, leg opening of briefs, etc...
 2. Maximum width of elastic is 1/8" to 1/4".

可自行組裝 self-installation : YES

適用機型 applicable model : F007K-W222, F007KD-W222



FHA

下擺車縫 Hemming

T恤、內衣、兒童服飾之下擺車縫；可隨需要調整下擺寬度，操作簡單
Suitable for bottom hemming of T-shirts, underwears, cuff of children's garments, etc... Able to adjust the width of hemming set to meet different demands, easy operation.

可自行組裝 self-installation : YES

適用機型 applicable model : F007K-W121, F007K-W122, F007K-W123, F007K-W162
F007KD-W121, F007KD-W122, F007KD-W123, F007KD-W162



FHK

二針三線·袖口自動車縫裝置 2 Needle 3 Thread Automatic Sleeve Hemming Device

1. T恤袖口、下擺氣動式自動送布、折布裝置·大幅節省人力及提升技術力
 2. 可依客戶車縫需求自行調整下擺折邊寬度(附刻畫尺)·下折布料距左針之左右寬度調整免裁切布料·節省材料成本
 3. 電眼自動檢測送布、折邊、抬壓腳裝置·作業完成後自動停機
 4. 最大產能約: 6000件~7000件(袖口)/8小時
1. The pneumatic automatic feeding and folding device is for T-shirts sleeve hemming, which can save manpower and upgrade technique.
2. Customers can adjust the width of hemming folding edge and the horizontal width between folding fabric and left needle as required. Since there is no need to cut the fabric in advance material cost can be saved.
3. The electric eye can detect feeding, edging and presser foot lifter automatically. After finishing the action, the operation will stop automatically.
4. The maximum productivity: 6000 – 7000 pc (cuff)/ 8 hours.

可自行組裝 self-installation : NO

適用機型 applicable model : F007KD-U131, F007KD-U132



FL

後拉滾輪裝置 Rear Puller

適用於薄到中厚布車縫如: 床單、被套、毛巾等(較厚的硬滑布類不可適用)·另附一組可調式下擺車縫組FHA(K)

Suitable for light to medium fabric, such as bedsheets, quilts, towels etc. With one set of adjustable bottom hemming device, FHA(K). (not suitable for the hard and slip fabric which is much heavy)

可自行組裝 self-installation : NO

適用機型 applicable model : F007K-W121/FHA, F007K-W122/FHA, F007K-W123/FHA,
F007K-W162/FHA, F007K-W222/FQ
F007KD-W121/FHA, F007KD-W122/FHA, F007KD-W123/FHA,
F007KD-W162/FHA, F007KD-W222/FQ



FP

折線條裝置 Crinkle Seaming

運動服裝·牛仔服飾或其他服飾之凸面折線條車縫·車縫時可於折線條內另加縫線繩·以增加凸線條之立體感和裝飾效果

To sew a decorative convex stripe on sportswears, jeans or other clothes, can also add extra stripe inside convex to increase the effects of convexity and decoration.

可自行組裝 self-installation : YES

適用機型 applicable model : F007K-U122-232, F007KD-U122-232



FQ

上帶滾邊車縫 Tape Binding

1. T恤、內衣褲、兒童服飾等之襯帶或包邊車縫
2. 本裝置與機器一起訂購時會加附FG組·但個別購買FQ元件時則不另附FG組
3. 喇叭標準規格為入布寬度1-3/8"·出布寬度為1/2"·捲成三折·若需要標準品以外之尺寸·請訂購時特別註明·但交期和費用另計
4. 本裝置有三種訂購方式:

1. For tape binding on openings of leg or underwear, T-shirt, etc...
2. If purchased machine with FQ, we will also attach FG. If purchase FQ device only, no FG attached.
3. Binder's standard opening size is 1-3/8" wide and finished size is 1/2" wide in 3 folds. Please remark if need another size when ordering, delivery date and cost will be re-calculated.
4. Ways to order the device:

機型 Model	FQ	FG	FQ 規格組 FQ Gauge Set	喇叭 Binder
F007K-W222-240/FQ	√	√	√	√
F007K-W222-240	X	X	√	X
F007K-W222-240/FQP	√	√	√	X

可自行組裝 self-installation : YES

適用機型 applicable model : F007K-W222, F007KD-W222



FR

右切刀修布裝置 Right Hand Side Trimmer

修齊兩片布接縫之下方多餘之布料，使車縫品質更加美觀

Right hand side waste fabric trimming, ensures better sewing quality.

可自行組裝 self-installation : NO

適用機型 applicable model : F007K-W522



FSM 花飾滾邊車縫 Ornamental Tape Binding

適用於T恤衫、襯衫等領口及下擺、袖口等花飾滾邊車縫，附有四組花飾凸輪可變化成數百種車縫花樣

Suitable for ornamental tape binding of neck band, bottom or cuff of T-shirts, shirts, etc... Four sets of cam create hundreds of patterns.

可自行組裝 self-installation : NO

適用機型 applicable model : F007K-W222, F007KD-W222



FSP

雙勾針上布條裝置 Double Looper Tape Binding

雙針雙勾針布條貼縫裝置，例如男內褲門襟

This device is specially designed for tape binding on cross seaming of men's briefs or sportswears.

壓具代碼 Presser Foot Code	入布寬度 Tape Width	出布寬度 Finish Width	適用機型 Applicable Model
P5118 (含喇叭) P5118 (binder included)	25mm	12mm	F007K(D)-U712A
P5117 (含喇叭) P5117 (binder included)	21mm	10mm	F007K(D)-U712

可自行組裝 self-installation : NO

適用機型 applicable model : F007K-U712, F007KD-U712



FSR

捲疊縫 Lap Seaming

本機種設計特殊之左右齒差動方式，能使捲疊縫縫紉更順暢，車縫後左右兩片均一無長短之虞；適用於西褲、休閒褲、牛仔褲薄至厚布料等之捲疊縫

Differential ratio of left and right feed dog can be adjusted separately for lap seaming to ensure symmetrical length to both left and right fabric. Applicable to trousers, casual pants and jeans, etc...

可自行組裝 self-installation : NO

適用機型 applicable model : F007K-U712, F007KD-U712



FW



FWP

四針六線環縫車縫裝置 Four-needle Flat Seaming

用於一般內衣褲二片布接縫處之接縫和補強，無需先經由拷克車拷邊再飾縫，牢固美觀，可附加喇叭 (B417R) 做貼帶補強用組件代號FWP

For flat seaming 2 pieces of fabric, equipped with fabric guide for easy operation.

FWP: Folder(B417R) is optional, for tape attaching.

可自行組裝 self-installation : NO

適用機型 applicable model : F007K-W922, F007KD-W922



FY

褲袋裡布車縫 Pocket Lining Seaming

用於褲袋之縫製，三針三勾一上叉針可強化縫合，增加產品之牢固。西服、工作服等衣袋和褲袋內裡之縫紉工程

This is a 3 needles 3 loopers 1 spreader machine, and special for seaming the shell fabric and lining of pocket in trousers or working pants in simple operation to increase sewing quality and efficiency.

可自行組裝 self-installation : NO

適用機型 applicable model : F007K-W722, F007KD-W722



LFA

直向電動送帶裝置 Electric Tape Feeding Device

利用電子馬達帶動鬆緊帶，使其放鬆到零鬆緊狀況，並可控制所需鬆緊帶之長短，使車縫時鬆緊度能一致

電壓：110V / 220V

Elastic type is fed by electric motor to achieve zero tension. Elastic tape length can be easily adjusted to expect length to ensure elasticity consistency.

Voltage, 110V / 220V

可自行組裝 self-installation : YES

適用機型 applicable model :

C007KP/FE, C007KP/FFC, C007KP/CR/FE, C007KP/CR/FFC, F007K/FE, F007K/FFC, F007K/FFD, F007K/FFP, F007K/FSP, F007K/FBP, F007K/FWP, F007K/FR/FE, F007K/FR/FFC, F007KD/FE, F007KD/FFP, F007KD/FSP, F007KD/FBP, F007KD/FWP



LF290 抖帶輪 Untangle Wheel

可選配安裝於LFA (送帶裝置) · 以逆轉的方式 · 抖動鬆緊帶 · 做為送帶前的處理
電壓：110V / 220V

An optional device to be equipped with LFA (tape feeding device). Untangling the elastic tape by reverse rotation wheel is a pre-feeding process.

Voltage, 110V / 220V

可自行組裝 self-installation : YES

適用機型 applicable model : MODEL w/LFA

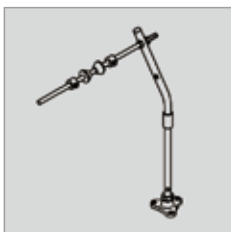

LS-A 上方帶盤 Upper Tape Holder

置於上前方放布條或鬆緊帶

For top feeding tape or elastic.

可自行組裝 self-installation : YES

適用機型 applicable model :

C007KP/FE, C007KP/FFC, C007KP/CR/FE, C007KP/CR/FFC, F007K/FE, F007K/FFC, F007K/FFD, F007K/FFP, F007K/FSP, F007K/FBP, F007K/FWP, F007K/FR/FE, F007K/FR/FFC, F007KD/FE, F007KD/FFP, F007KD/FSP, F007KD/FBP, F007KD/FWP



PCC 拷克倒骨蓋縫裝置 Overlock-Seam Covering (Fold-down Type)

1. 適中厚至厚布料經四線拷克車包縫後之飾縫
2. 對於運動服、領子、衣襟、袖管之拷邊車縫後加以單面或雙面裝飾環縫 · 可增加服飾之美觀及車縫之牢固。利用導布片及壓具上之壓刀導縫 · 可避免車縫時彎曲不直

1. Overturned seam covering for medium to heavy fabric after 4 thread plain seaming.

2. Suitable for neck openings, sleeve, cuff or bottom of sportswears, T-shirts, etc...

With fabric guide and special presser foot, making sewing easy and more efficient.

可自行組裝 self-installation : YES

適用機型 applicable model : S007K all models, S007KD all models

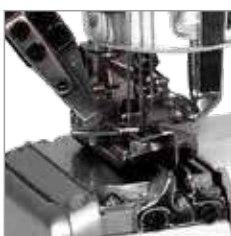

PCE 拷克立骨蓋縫裝置 Overlock-seam Covering (Flattening Type)

1. 適中厚布料經三線拷克車包縫後之飾縫
2. 對於運動服、領子、衣襟、袖管之拷邊車縫後加以單面或雙面裝飾環縫 · 可增加服飾之美觀及車縫之牢固。利用導布片及壓具上之壓刀導縫 · 可避免車縫彎曲不直

1. Bulging seam covering for medium fabric after 3 thread plain seaming.

2. Suitable for neck openings, sleeve, cuff or bottom of sportswears, T-shirts, etc...

With fabric guide and special presser foot making sewing easy and more efficient.

可自行組裝 self-installation : YES

適用機型 applicable model : S007K all models, S007KD all models



PCH

下擺車縫 Bottom Hemming

T恤、內衣及兒童服飾之下擺及袖口之車縫，可隨需要調整下擺飾縫組寬度，操作簡單快捷
Suitable for the bottom hemming of T-shirts, underwears, cuff of children's garments, etc...
Able to adjust the width of hemming set to fit demands, easy operation.

可自行組裝 self-installation : YES

適用機型 applicable model : S007K all models, S007KD all models



RL

筒型衣物撐開滾輪組(長輪) Tubular Extending Roller (Long Type)

專用於輔助筒型衣物之車縫

Especially used to assist with tubular cloth sewing.

可自行組裝 self-installation : YES

適用機型 applicable model : C007KP/CY, C007L



RLP

筒型衣物撐開滾輪組(短輪 + 斜輪) Tubular Extending Roller (Short+ Cone Type)

專用於輔助筒型衣物之車縫

Especially used to assist with tubular cloth sewing.

可自行組裝 self-installation : YES

適用機型 applicable model : C007KP/CX



RLQ

筒型衣物撐開滾輪組 Tubular Extending Roller

專用於輔助筒型衣物之車縫

Especially used to assist with tubular cloth sewing.

可自行組裝 self-installation : YES

適用機型 applicable model : C007KP/CZ

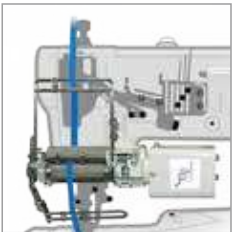

SMK

電子計數式送帶 Electric Metering type tape feeding

SMK1 - □ - □

A: 包縫機 · 上送帶
Overlock, Top Feed
C: 繃縫機 · 上送帶
Interlock, Top Feed
D: 繃縫機 · 下送帶
Interlock, Bottom Feed
E: 繃縫機 · 側送帶
Interlock, Side Feed

O1 附定位器 · 適合簡易伺服或離合器馬達
With synchronizer for simple servo motor or clutch motor
O2 以中繼線 · 連接伺服馬達
Connected to servo motor by encoder cable

可自行組裝 self-installation : YES

適用機型 applicable model : C007KP/CR, F007/CR



SRL

左切刀修布裝置(小筒用) Left Hand Side Trimmer (For Small Cylinder Bed)

修齊兩片布接縫左下方多餘之布料，使車縫後更加整齊美觀
Left edge trimmer makes fabric edge aligned to seam.

可自行組裝 self-installation : NO
適用機型 applicable model : S007KD-812



STC

張力控制式送帶 Tension sensor type tape feeding

STC1 - □ - □

U: 上送帶
Top Feed
B: 下送帶
Bottom Feed
S: 側送帶
Side Feed

01 附定位器，適合簡易伺服或離合器馬達 With synchronizer for simple servo motor or clutch motor
02 以中繼線，連接伺服馬達
Connected to servo motor by encoder cable

可自行組裝 self-installation : YES
適用機型 applicable model : C007KP/CR, F007/CR

UT 自動切線組 Automatic Thread Trimmer Set



上切
Top Trimmer



下切
Bottom Trimmer



夾線
Thread Gripping



吹風
Thread Blowing

機型 Model	代號 Code	功能 Function				驅動 Drive	
		上切 Top Trimmer	下切 Bottom Trimmer	夾線 Thread Gripping	吹風 Thread Blowing	氣動 Pneumatic	電動 Electrical
F007K F007KD	UTG	√	√		*	√	
	UTH		√	選配 Optional	√		
	UTJ	√	√				√
	UTK		√	√			
C007KP C007L	UTP	√	√		*	√	
	UTQ		√	選配 Optional	√		
	UTR	√	√				√
	UTS		√	√			
S007K S007KD U007	UTT	√	√		*	√	
	UTU		√	選配 Optional	√		
	UTX	√	√				√
	UTY		√	√			



*配件盒附吹風管，客戶若不需上網線時，可自行將上切刀改為吹風
Thread blowing device is included in the accessory box. If the coverstich thread is not required, users may install blowing device instead of upper thread trimmer.

DC 下軸型直驅伺服馬達 Lower main shaft type Direct-drive servo motor

DCL H D 1 - 1

① ② ③ ④ ⑤

- ① 機種別 Model
DFK : F007K
DCK : C007KP
DCL : C007L
DSK : S007K
- ② 系列別 Motor Series
H : H系列馬達電控系統
H-Series motor
U : U系列馬達電控系統
U-Series motor
- ③ 認證項目 Certification
空白 : CE認證
none : CE Certification
D : 巴西認證
D : Brazil Certification
- ④ 代別 Version
1 : 第一代 first version
- ⑤ 功能別 Funtion
0 : 簡易型 (針上/下定針) Simple type (needle position function)
1 : 氣動式多功能型 Pneumatic, Multi-functional
2 : 電動式多功能型 Electric, Multi-functional

直驅電控箱組 Direct drive electric control box set		配件表 Accessories list																	
		UTG	UTH	UTJ	UTK	FSC	UTP	UTQ	UTR	UTS	CAR	CR	CRL	UTT	UTU	UTX	UTY	SAR	CAF
F007K	DFKH③④-1	●	●			●													●
	DFKH③④-2			●	●														
C007KP	DCKH③④-1						●	●			●	●	●						●
	DCKH③④-2							●	●										
C007L	DCLH③④-1						●	●				●	●						●
	DCLH③④-2							●	●										
S007K	DSKH③④-1													●	●			●	●
	DSKH③④-2															●	●		
U007	DUKH③④-1													●	●				
	DUKH③④-2															●	●		
F007K	DFKU③④-0	(斜線表示不適用)																	
	DFKU③④-1	●	●																●
	DFKU③④-2			●	●														
C007KP	DCKU③④-0	(斜線表示不適用)																	
	DCKU③④-1						●	●											●
	DCKU③④-2							●	●										
C007L	DCLU③④-0	(斜線表示不適用)																	
S007K	DSKU③④-0	(斜線表示不適用)																	

TABLE

桌板代號 Item No.	尺寸 / Size (mm)			說明 Description	適用機型 Applicable Model	備註 Remark
	長 Length	寬 Width	厚 Thickness			
C007L-T23	1200	540	45	半沉式 Semi-submerged	C007L, C007LD, C007LX	
C007L-T25	1200	540	45	上乘式 Non-submerged	C007L, C007LD, C007LX	
C007L-T30	1200	540	45	上乘式 Non-submerged	C007LD	
C007K-T23	1200	540	45	半沉式 Semi-submerged	C007K, C007KD, C007KP, C007JP, S007K, S007KD, U007	
C007K-T25	1200	540	45	上乘式 Non-submerged	C007K, C007KD, C007KP, C007JP, S007K, S007KD, U007	
C007K-T26	1200	540	45	半沉式 Semi-submerged	C007K/CFC, C007KP/CFC	
C007-T30	1200	540	45	上乘式 Non-submerged	C007K, C007KP, C007JP, S007K, U007	
C007K-T32	1200	540	45	上乘式 Non-submerged	C007K, C007KP, C007JP, S007K, U007 for SILMAQ	
C007K-T33	1200	540	45	上乘式 Non-submerged	C007K, C007KP, C007JP, S007K, U007 DD Motor Model for SILMAQ	
C007KP-T25	1200	540	45	上乘式 Non-submerged	C007KP for CR, CRL, UT	搭桌板散熱風扇 Table board cooling fan
F007K-T	1200	540	45	半沉式 Semi-submerged	F007K	
F007K-T1	1200	540	45	半沉式 Semi-submerged	F007K/FR	
F007K-T2	1200	540	45	半沉式 Semi-submerged	F007KD/FFT/FHK	
F007K-T3	1200	540	45	全沉式 Fully-submerged	F007K	
F007K-T4	1200	540	45	半沉式 Semi-submerged	F007KD	
F007K-T5	1200	540	45	半沉式 Semi-submerged	F007KD/FR	
F007KD-T3	1200	540	45	全沉式 Fully-submerged	F007KD	

DOUBLE CHAINSTITCH

VC008A

-

04

064

P

/

VCE

針數
Needle Numbers

後拉引滾輪
Rear Pullers

配件
Device

機種別 Model

VC008A 筒形多針縫紉機(高貫穿力型)
Multineedle Cylinder Bed Double Chainstitch
Machine (High Penetration Power Type)

VC008B 筒形多針縫紉機(4~6針高速型)
Multineedle Cylinder Bed Double Chainstitch
Machine (4~6 Needles High Speed Type)

HF008A 平台型牛仔用二重環縫紉機
Flat Bed Double Chainstitch Machine for
Jeans

NC008 針送牛仔褲腰車
Needle-Feed Cylinder Bed Double
Chainstitch Machine for Jeans Waistband

等距針距

Equal Distance Between Needles

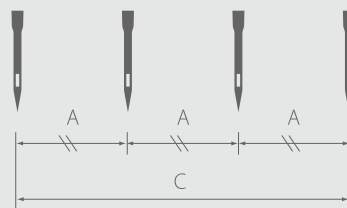

不等距

Unequal Distance Between Needles

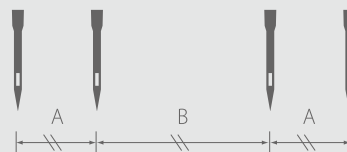

DOUBLE CHAINSTITCH DD SERVO MOTOR

VC008A - 04085P / VWLB / FH / DV□□

DV□□ VC008A/B, HF008A, NC008型直驅電控組
Direct-Drive Servo Motor for VC008A/B, HF008A,
NC008

VC008A / B SERIES FEATURES



VC008A

筒型多針縫紉機(高貫穿力型)

Multineedle cylinder bed double chainstitch machine (High Penetration Power Type)



完全自動供油，勾針縱向運動機構，多針雙重鏈式縫

Automatic lubrication system, vertical looper mechanism, multineedle chainstitch mechanism.



採用獨立勾針座，可變化不同的針位元組合，達到一機多用的功能（選配）

Using independent looper holder and can easily change different needle position, Multi-function machine design.(optional)



筒型機身設計，方便環型衣物縫紉

Cylinder machine frame design, easy sewing operation for circular cloth.



按鈕式縫距調整模式，調整簡便快速

Stitch length adjustment by knob, easy and fast.



左側附一輔助設計，拉布穩定，出布更順暢，維護便利

Using one supportive puller on left side which can stabilize the pulling and sewing process.



適用於多種工序的縫紉，適合針織類高級衣物之裝飾車縫

Suitable for multi sewing process, high quality knit material and decorative sewing.



新型軸承式滾輪，縫製時拉布與出布更順暢穩定

New bearing type rear puller handles the material with better stability.

VC008B

筒型多針縫紉機 (4~6針高速型)

Multineedle cylinder bed double chainstitch machine (4~6 needles High Speed Type)

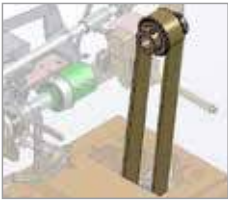

使用皮帶傳動來驅動上下軸，實現高速穩定的縫製

New mechanism uses the belt to drive both upper and lower shaft, provides faster and more stable sewing experience.



平順且低震動，車縫薄料得心應手





High performance with thin material, less vibration and smoother movement.



新型軸承式滾輪，縫製時拉布與出布更順暢穩定



New bearing type rear puller handles the material with better stability.

V1 Device

Model	Specification	 	 	每單位 (Unit)=3.2mm=1/8"																										Remark	
				1	2	3	4	5	6	7	8	9	10	11	12	13	14	15	16	17	18	19	20	21	22	23	24	25	26		
VC008A- VC008B-	04064P	4	8	1/4"(6.4mm)																											
	04085P			1/3"(8.5mm)																											
	04095P			3/8"(9.5mm)																											
	04106P			5/12"(10.6mm)																											
	04127P	1/2"(12.7mm)																													
	04A32-032P	6	12	(1/4-1/8-1/8-1/4")*3 (6.4-3.2-3.2-6.4mm)*3																									A		
	04A64P			1/4"(6.4mm)																											
	12A32-032P			(1/4-1/8-1/8-1/4")*3 (6.4-3.2-3.2-6.4mm)*3																											
	12A64P	1/4"(6.4mm)																												B	
VC008A-	12048P	12	24	3/16"(4.8mm)																											
	12064P			1/4"(6.4mm)																											
	12050P			1/5"(5.0mm)																											
	13032P			1/8"(3.2mm)																											C
	13064P			1/4"(6.4mm)																											
	1332-032P			(1/4-1/8-1/8-1/4")*3 (6.4-3.2-3.2-6.4mm)*3																											
	17032P			1/8"(3.2mm)																											D
	21032P			1/8"(3.2mm)																											E
	23032P			1/8"(3.2mm)																											F

A: 13 針規格組, 配 4 組針 / 勾針
 B: 13 針規格組, 配 6 組針 / 勾針
 C: 13 針規格組, 配 13 組針 / 勾針
 D: 17 針規格組, 配 17 組針 / 勾針
 E: 21 針規格組, 配 21 組針 / 勾針
 F: 23 針規格組, 配 23 組針 / 勾針

A: 13-Needle gauge set with 4 sets of needle/ looper.
 B: 13-Needle gauge set with 6 sets of needle/ looper.
 C: 13-Needle gauge set with 13 sets of needle/ looper.
 D: 17-Needle gauge set with 17 sets of needle/ looper.
 E: 21-Needle gauge set with 21 sets of needle/ looper.
 F: 23-Needle gauge set with 23 sets of needle/ looper.

	1.4-3.6		12		UOX113GS #11~#14		S.P.M. (Max)	4500
--	---------	---	----	---	---------------------	---	-----------------	------

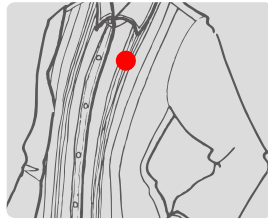

4針機型

4-Needle type

VC008A-04XXX
VC008A-04XXX-XXX

12針機型

12-Needle type

VC008A-12XXX
VC008A-12XXX-XXX
VC008A-13XXX
VC008A-13XXX-XXX
VC008A-17XXX
VC008A-21XXX
VC008A-23XXX

















一般平縫

完全自動給油·勾針縱向運動機構·筒型車台·利於圓筒型衣物之縫紉·適用於一般高級衣物之裝飾車縫

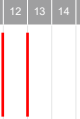
GENERAL SEAMING

Cylinder bed automatic oiling, back and forth loopers driving mechanism, suitable for decorative sewing on high quality dress or tubular goods.

V2 Device

Model	Specification					2.5-5		12		UOX113GS #11~#14		S.P.M. (Max)	4000	Remark
VC008A	1132-064P	11	22	(1/8-1/4-1/8") (3.2-6.4-3.2mm)										

[三合一] 褲頭車縫

本機型適用鬆緊帶皺褶型·平坦型·薄牛仔·可以彈性組合出各種常用的4針針位組如1/4-1/4-1/4, 1/4-3/4-1/4...等



[3 in 1] Waist band sewing

This model is applicable to elastic band wrinkled type, flat type, light denim, which offers various 4-needle gauges by one set.
E.g.: 1/4-1/4-1/4, 1/4-3/4-1/4...etc.







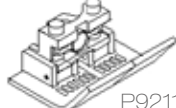

選購配件 OPTIONAL DEVICE

VCE

 VCL08S	細齒上拉輪 (鋼質)·薄牛仔 Fine teeth type upper puller (steel).light denim.
 VCL16P VCL28	平輪組 (PU 材質) Flat type puller set (PU)
 P9211A-A	二段式壓腳 Two-piece type presser foot

V3  Device

				 mm	 mm	 mm	Needle No.	 S.P.M. (Max)
VC008A- VC008B-	04064P/VCE	4	8	1/4"(6.4mm)	1.4-3.6	12	UOX113GS #11~#14	4000
	04085P/VCE	4	8	1/3"(8.5mm)	1.4-3.6	12	UOX113GS #11~#14	4000
	04095P/VCE	4	8	3/8"(9.5mm)	1.4-3.6	12	UOX113GS #11~#14	4000
	04106P/VCE	4	8	5/12"(10.6mm)	1.4-3.6	12	UOX113GS #11~#14	4000
	04127P/VCE	4	8	1/2"(12.7mm)	1.4-3.6	12	UOX113GS #11~#14	4000



VC008B-04064P/VCE

褲頭鬆緊帶車縫

用於運動褲或運動短褲等圓筒型衣褲腰部鬆緊帶的包縫。本機型可有兩種縫合的方式：
(1)環型鬆緊帶布料折邊縫 (2)拷克後上環型鬆緊帶包縫

ELASTIC INSERTING / ATTACHING





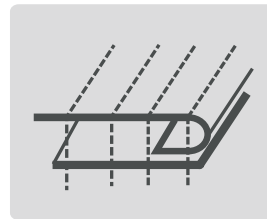
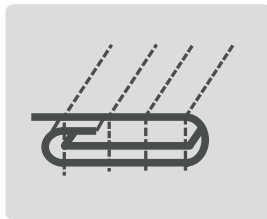

Inserting and attaching elastic on waistband of jogging suits, sportswears or shirts etc., two types of sewing functions are available :

1. To attach tubular seamless elastic waistband.
2. To cover sewing on elastic after overlock seaming.

選購配件 OPTIONAL DEVICE
VAD ,VUT , RL



V4  Device

				 mm	 mm	 mm	Needle No.	 S.P.M. (Max)
VC008A-	04064P/VWL	4	8	1/4"(6.4mm)	1.4-3.6	12	UOX113GS #11~#14	4000
	04085P/VWL	4	8	1/3"(8.5mm)	1.4-3.6	12	UOX113GS #11~#14	4000
	04095P/VWL	4	8	3/8"(9.5mm)	1.4-3.6	12	UOX113GS #11~#14	4000
	04106P/VWL	4	8	5/12"(10.6mm)	1.4-3.6	12	UOX113GS #11~#14	4000
	04127P/VWL	4	8	1/2"(12.7mm)	1.4-3.6	12	UOX113GS #11~#14	4000



VC008A-04085P/VWL

褲頭鬆緊帶車縫 (附B413喇叭)

鬆緊帶送帶滾輪裝置能依據機台之運轉速度送帶，可準確控制鬆緊帶長度與鬆緊度。操作簡便，適用於慢跑褲、運動褲、男女內褲等褲頭之鬆緊帶車縫

註：B413喇叭可用鬆緊帶尺寸為 38mm

ELASTIC ATTACHING (WITH FOLDER B413)

Elasticity and length feeding can be accurately controlled according to sewing speed of machine. Easy operation for elastic inserting and attaching on waistband of jogging pants, sportswears, briefs etc.

Remark : Elastic size 38mm for folder B413

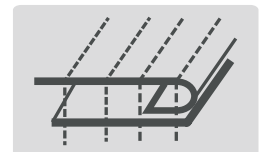

選購配件 OPTIONAL DEVICE
FH

V5 Device

							Needle No.	
VC008A-	04064P/VWLB	4	8	1/4"(6.4mm)	1.4-3.6	12	UOX113GS #11~#14	4000
	04085P/VWLB	4	8	1/3"(8.5mm)	1.4-3.6	12	UOX113GS #11~#14	4000
	04095P/VWLB	4	8	3/8"(9.5mm)	1.4-3.6	12	UOX113GS #11~#14	4000
	04106P/VWLB	4	8	5/12"(10.6mm)	1.4-3.6	12	UOX113GS #11~#14	4000
	04127P/VWLB	4	8	1/2"(12.7mm)	1.4-3.6	12	UOX113GS #11~#14	4000

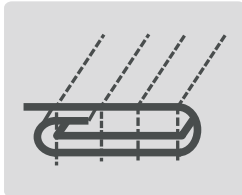

褲頭鬆緊帶車縫 (附B411喇叭及撐開滾輪組)

鬆緊帶送帶滾輪裝置能依據機台之運轉速度送帶，可準確控制鬆緊帶長度與鬆緊度，操作簡便，適用於慢跑褲、運動褲、男女內褲等褲頭之鬆緊帶車縫

ELASTIC INSERTING (WITH FOLDER B411 AND EXTENDING ROLLER)

Elasticity and length feeding can be accurately controlled according to sewing speed of machine. Easy operation for elastic inserting and attaching on waistband of jogging pants, sportswears, briefs etc.

喇叭尺寸 Folder Size	成品尺寸 Finished Size	鬆緊帶尺寸 Elastic Tape Size	適用機型 Applicable Model
B411	33 mm	31 mm	04095
B411P	30 mm	28 mm	04085
B411Q	42 mm	40 mm	04127
B411R	25 mm	23 mm	04064
B411S	36 mm	34 mm	04106

選購配件 OPTIONAL DEVICE

FH

V6 Device

							Needle No.	
VC008A-	04064P/VWLC	4	8	1/4"(6.4mm)	1.4-3.6	12	UOX113GS #11~#14	4000
	04085P/VWLC	4	8	1/3"(8.5mm)	1.4-3.6	12	UOX113GS #11~#14	4000
	04095P/VWLC	4	8	3/8"(9.5mm)	1.4-3.6	12	UOX113GS #11~#14	4000
	04106P/VWLC	4	8	5/12"(10.6mm)	1.4-3.6	12	UOX113GS #11~#14	4000
	04127P/VWLC	4	8	1/2"(12.7mm)	1.4-3.6	12	UOX113GS #11~#14	4000
	12048P/VWLC	12	24	3/16"(4.8mm)	1.4-3.6	12	UOX113GS #11~#14	4000
	12064P/VWLC	12	24	1/4"(6.4mm)	1.4-3.6	12	UOX113GS #11~#14	4000

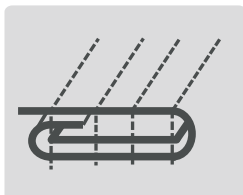

褲頭鬆緊帶車縫 (附VCE導片)

鬆緊帶送帶滾輪裝置能依據機台之運轉速度送帶，可準確控制鬆緊帶長度與鬆緊度，操作簡便，適用於慢跑褲、運動褲、男女內褲等褲頭之鬆緊帶車縫







ELASTIC INSERTING /ATTACHING (WITH VCE FABRIC GUIDE)

Elasticity and length feeding can be accurately controlled according to sewing speed of machine. Easy operation for elastic inserting and attaching on waistband of jogging pants, sportswears, briefs etc.

選購配件 OPTIONAL DEVICE

FH

V7  Device

							Needle No.	
VC008A-	06048P/VPL	6	12	3/16"(4.8mm)	1.4-3.6	12	UOX113GS #11~#14	4000
VC008B-	06064P/VPL	6	12	1/4"(6.4mm)	1.4-3.6	12	UOX113GS #11~#14	4000



VC008B-06064P/VPL

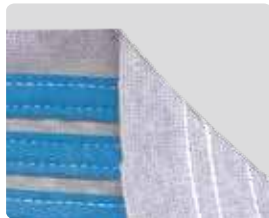
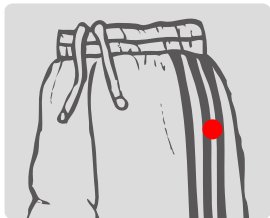

上帶車縫

適用於裝飾條帶、運動衣褲等車縫，效率高、品質穩定

TAPE ATTACHING

Suitable for attaching ornament tape on sportswears.
For high efficiency and perfect quality sewing.







選購配件 OPTIONAL DEVICE

LSA

若需要更高階機型，請參考
ASV-ATS100A (P.16)
For advanced model, please
refer to ASV-ATS100 (P.16)



V8  Device

							Needle No.	
VC008A-	12048P/VPQ	12	24	3/16"(4.8mm)	1.4-3.6	12	UOX113GS #11~#14	4000
	12064P/VPQ	12	24	1/4"(6.4mm)	1.4-3.6	12	UOX113GS #11~#14	4000



VC008A-12064P/VPQ

鬆緊帶抽皺縫裝置

適用於女皺

折連身衣裙等腰邊鬆緊線皺折，如女用襯衫，游泳衣，枕頭套，兒童衫等均能車縫順暢





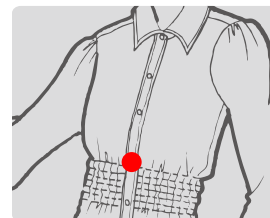

注：勾針底線宜用彈性線

ELASTIC THREAD SHIRRING SEWING

Suitable for sewing ornamental shirring with elastic thread on women's blouses, swimsuits, dresses, pillowcases, and children's shirts etc.

Remark : Suggested to use elastic thread for lower looper



								
VC008A-	12048P/VPQ-K	12	24	3/16"(4.8mm)	1.4-3.6	12	UOX113GS #11~#14	4000
	12064P/VPQ-K	12	24	1/4"(6.4mm)	1.4-3.6	12	UOX113GS #11~#14	4000



VC008A-12048P/VPQ-K

鬆緊帶抽皺縫裝置

適用於女皺褶連身衣裙等腰邊鬆緊線皺褶，如女用襯衫、游泳衣、枕頭套、兒童衫等均能車縫順暢

註：

1. 勾針底線宜用彈性線
2. 增加VWL組可穩定彈性線的鬆緊度讓車縫更平順美觀，不跳針
3. 將彈性線安裝於桌板下，讓彈性線車縫更順暢
4. 本機為多功能車，可調為VWL、VPQ或一般車使用





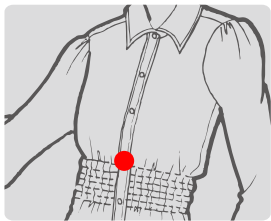

ELASTIC THREAD SHIRRING SEWING

Suitable for sewing ornamental shirring with elastic thread on women's blouses, swimsuits, dresses, pillowcases, and children's shirts etc.

Remark :

1. Suggested to use elastic thread for lower looper.
2. The added VWL set will further stabilize the tension of elastic thread and make sewing process more smoothly, also can avoid stitch skipping.
3. Holds the elastic thread under the table to make sewing process more smoothly.
4. This is a multifunctional machine, can easily adjust to VWL, VPQ, or standard machine.



								
VC008A-	12048P/VPS	12	12	3/16"(4.8mm)	1.4-3.6	12	DV-K25 #18-21	4000
	12064P/VPS	12	12	1/4"(6.4mm)	1.4-3.6	12	DV-K25 #18-21	4000



VC008A-12064P/VPS

鬆緊帶抽皺縫裝置

適用於女皺褶連身衣裙等腰邊鬆緊線皺褶，如女用襯衫、游泳衣、枕頭套、兒童衫等均能車縫順暢





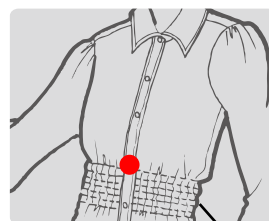

註：針線用彈性線，以勾針為勾線功能不穿線，為101車縫式樣

ELASTIC THREAD SHIRRING SEWING

Suitable for sewing ornamental shirring with elastic thread on women's blouses, swimsuits, dresses, pillowcases, and children's shirts etc.

Remark : Needle uses elastic thread and looper without thread. It's 101 sewing type.



								
				mm	mm	mm	Needle No.	S.P.M. (Max)
VC008A-	12048P/VSC	12	36	3/16"(4.8mm)	1.4-3.6	12	UOX113GS #11~#14	2500
	12064P/VSC	12	36	1/4"(6.4mm)	1.4-3.6	12	UOX113GS #11~#14	2500

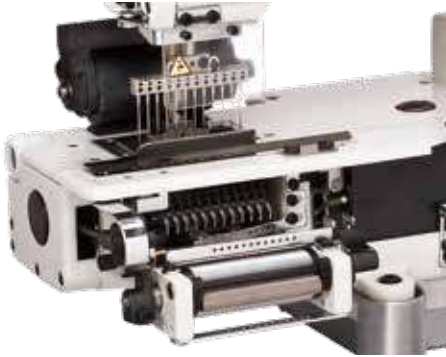

VC008A-12064P/VSC

鬆緊帶抽皺縫裝置

彈性線直送不打線圈，由針線與勾針線上下包覆，車縫成品效果較VPQ薄，且皺褶可拉伸至完全平坦

ELASTIC THREAD SHIRRING SEWING

Elastic thread is straight, not looped, which is fixed by needle thread and looper thread. The finish is thinner than VPQ and the shirring becomes flat as it is pulled extensively.

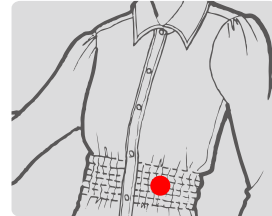

HF008A SERIES FEATURES

HF008A

平台型牛仔用二重環縫紉機 Flat bed double chainstitch machine for jeans



精心設計之供油系統及零配件精度加工，延長機器使用壽命

Using unique design of lubrication system and attachments to extend the machine lifetime.



按鈕式縫距調節可適合多品種生產

Stitch length adjustment by knob, suitable for all different kinds of materials.



上下滾輪之雙重配合使出布更順暢

Upper and lower puller design to make sewing process more stable.

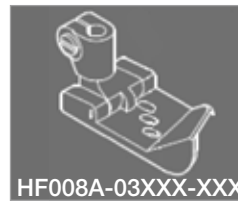

HF008A-03XXX-XXX

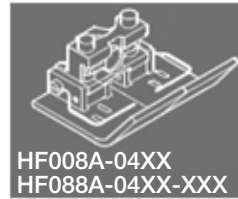
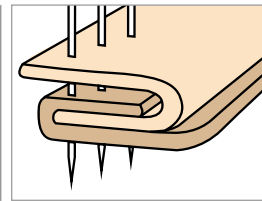

HF008A-04XX
HF088A-04XX-XXX

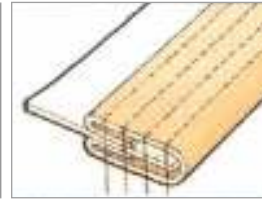

適用工作服、牛仔褲之搭縫(埋夾縫)與褲頭車縫

Suitable for tape binding on waistband of workwear pants, jeans.

H1 Device

	2	4	1/4"(6.4mm)	1.8-3.6	12	UYX128GAS#14~#16	4200
HF008A-02064P/HHD	2	4	1/4"(6.4mm)	1.8-3.6	12	UYX128GAS#14~#16	4200
HF008A-03064P/HHD	3	6	1/4"(6.4mm)	1.8-3.6	12	UYX128GAS#14~#16	4200



HF008A-02064P/HHD

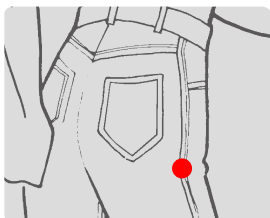

埋夾縫

適用於薄至厚料如工作服、牛仔褲之搭縫

註：一般出車，均不附喇叭，如有需要可依以上規格訂製

LAP SEAMING

To lap seaming on light to heavy material such as workweares or jeans, etc...

Remark : Folder is not included. Please specify folder no. when ordering.

可選擇之規格 Available Model		布料 Material	喇叭代號 Folder No.
02064/HHD 03064/HHD	1/4"	薄料 light	B511
		中厚料 medium	B511P
		厚料 heavy	B511Q

H2  Device

HF008A-03064P/HTF	3	6	1/4"(6.4mm)	1.8-3.6	12	TVX5 #18~#21	4200
-------------------	---	---	-------------	---------	----	--------------	------



HF008A-03064P/HTF

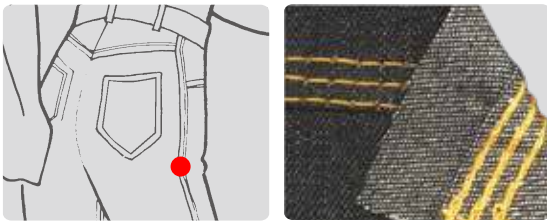

搭縫

適用於中厚布料至極厚布料如工作服、牛仔褲等粗斜紋布之搭縫用註：一般出車，均不附喇叭，如有需要可依以上規格訂製

LAP SEAMING

To lap seaming on medium to extra heavy material such as workwears or jeans, etc...

Remark : Folder is not included. Please specify folder no. when ordering.

布料 Material	喇叭代號 Folder No.
中厚料 Medium	B511P
厚料 Heavy	B511Q
極厚料 Extra Heavy	B511R

H3  Device

HF008A-0464-254P/HPR	4	8	1/4-1-1/4" (6.4-25.4-6.4mm)	1.4-3.6	12	TVX5 #18~#21	4500
HF008A-0664-254P/HPR	4 (6)	8	1/8-1/8-1-1/8-1/8" (3.2-3.2-25.4-3.2-3.2mm)	1.4-3.6	12	TVX5 #18~#21	4500



HF008A-0664-254P/HPR/B530



HF008A-0464-254P/HPR

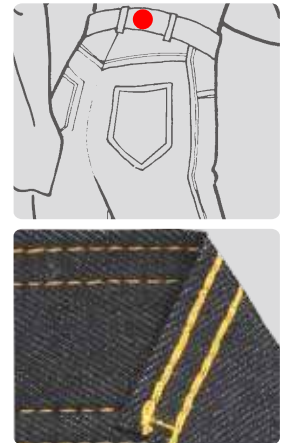

▲
*配備6針規格組，可彈性變換針距
*With 6-needle gauge set for various waistband size

選購配件	OPTIONAL DEVICE
	FH

褲頭上帶滾邊車縫

適用於厚料之工作褲、牛仔褲等褲頭之上帶滾邊一次成型車縫，可依布條之縫合樣式選擇喇叭

註：一般出車，均不附喇叭，如有需要可依以上規格訂製



WAISTBAND ATTACHING

For tape binding on waistband of workwears pants, jeans...etc. Refer to below table to find optional binders for desirable seams.





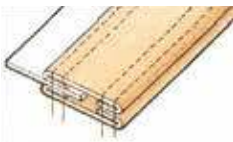
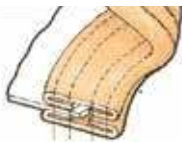
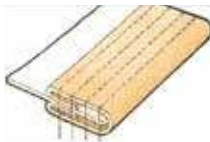

Remark : Binder is not included. Please specify binder no. when ordering.

H3

選配喇叭 OPTIONAL BINDER

成品尺寸 (Finished Size)	上下片直送 For Continuous Strips	上下片弧形 For Arched Type	側送喇叭 Side Feeding	前送喇叭 Front Feeding
1" (25mm)	-	-	-	B530
1- 1/8" (29mm)	-	-	-	B530P
1- 1/4" (32mm)	B516	B518	B519	B530Q
1- 3/8" (36mm)	B516P	B518P	B519P	B530R
1- 1/2" (38mm)	B516Q	B518Q	B519Q	B530S
1- 5/8" (42mm)	B516R	B518R	B519R	B530T
1- 3/4" (45mm)	B516S	B518S	B519S	B530U
縫合樣式 Seam Type				

H4 Device

						
HF008A-0464-254P/PMP	4	8	1/4-1-1/4" (6.4-25.4-6.4mm)	1.4-3.6	12	TVX5 #18~#21 4500
HF008A-0664-254P/PMP	4 (6)	8	1/8-1/8-1-1/8-1/8" (3.2-3.2-25.4-3.2-3.2mm)	1.4-3.6	12	TVX5 #18~#21 4500



HF008A-0664-254P/PMP/
B530

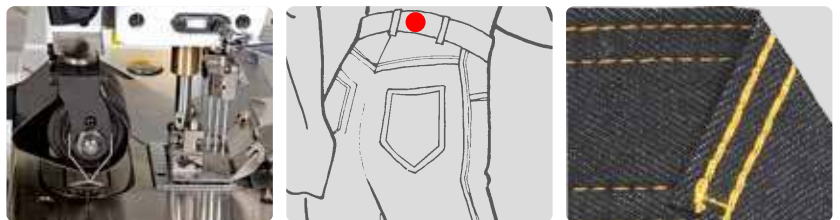







(可調整角度)褲頭上帶滾邊車縫

同HPR褲頭上帶滾邊車縫功能，但角度可進行調整；適用於有曲度之褲腰車縫

(ANGLE-ADJUSTABLE) WAISTBAND ATTACHING

Same waistband attaching function as HPR, with adjustable angle to process curved workpieces.

H5  Device

							
			mm	mm	mm	Needle No.	S.P.M. (Max)
HF008A-02056P/FBQ	2	3	7/32"(5.6mm)	1.8-3.6	12	UYX128GAS#10~#11	4200
HF008A-02064P/FBQ	2	3	1/4"(6.4mm)	1.8-3.6	12	UYX128GAS#14~#16	4200



HF008A-02064P/FBQ

褲耳車縫 (附雙邊切刀)

用本輔助件雙邊切刀裁布之功能，可將零碎之廢布利用來製作褲耳，減少布料消耗





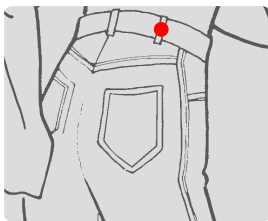

BELT-LOOP SEAMING (WITH RIGHT & LEFT FABRIC TRIMMER)

This machine is equipped with an adjustable fabric trimmer to cut excess fabric edge neatly, and seaming to belt loops for saving cost and increase efficiency.



可選擇之規格 Available Model	成品尺寸 Finished Size	喇叭代號 Folder No.	適用 Application
HF008A-02056P/FBQ	9 mm	FBQ14A	男女西褲 Trousers
	10 mm	FBQ14B	
HF008A-02064P/FBQ	12 mm	FBQ14C	牛仔布 Jeans

H6  Device

							
			mm	mm	mm	Needle No.	S.P.M. (Max)
HF008A-0464-254P/PMP/JD	4	8	1/4-1-1/4" (6.4-25.4-6.4mm)	1.4-3.6	12	TVX5 #18~#21	4500
HF008A-0664-254P/PMP/JD	4 (6)	8	1/8-1/8-1-1/8-1/8" (3.2-3.2-25.4-3.2-3.2mm)	1.4-3.6	12	TVX5 #18~#21	4500



HF008A-0664-254P/PMP/JD



牛仔褲腰車縫 (自動跳針)

車縫褲腰時可使用自動跳針機能避開不需縫製的地方

JEANS WAISTBAND ATTACHING (with Skip-stitch function)

When sewing waistband at the opening area, skip-stitch function can save your time of cutting the seam.

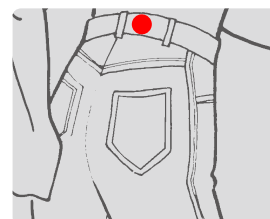

NC008 SERIES FEATURES

NC008

針送牛仔褲腰車

Needle-feed cylinder bed double chainstitch machine for jeans waistband



後拉輪能在高速車縫時讓送布均勻，線跡美觀

Rear puller allows stable material feeding and well-balanced seam.



可同步調整線跡長度與送布量的針送+下送送布機構

Needle feed and material feed can be adjusted synchronously.



可對應至16oz的丹寧布等重厚型布料

Work on heavy material like Denim, up to 16 oz.



最適合車縫牛仔褲腰，也可應用於牛仔褲的約克、捲邊縫、門襟車縫，上鬆緊帶

Designed for jeans waistband sewing, also can apply on jeans yoke seam, front, and elastic attaching.



配件 / DEVICE



HPR / 褲頭上帶滾邊車縫

適用於厚料工作褲・牛仔褲的上帶滾邊一次成型車縫
左右分開的下輪可用轉彎縫製・可依樣式選擇喇叭

HPR/Waistband Attaching Device

For tape binding on waistband of workwears pants, jeans...etc.
Refer to below table to find optional binders for desirable seams.



JD / 跳針裝置

避開褲腰車縫時不需下針的地方

Skip Stitch Device

Control freely to avoid stitches sewed on un-wanted working area.

選配喇叭 / OPTIONAL BINDER

成品尺寸 (Finished Size)	上下片直送 For Continuous Strips	上下片弧形 For Arched Type	側送喇叭 Side Feeding	前送喇叭 Front Feeding
1- 3/8" (36mm)	B516P	B518P	B519P	B530R
1- 1/2" (38mm)	B516Q	B518Q	B519Q	B530S
1- 5/8" (42mm)	B516R	B518R	B519R	B530T
1- 3/4" (45mm)	B516S	B518S	B519S	B530U
縫合樣式 Seam Type				

規格 / SPECIFICATION

NCO08							
			mm	mm	mm	Needle No.	S.P.M. (Max)
NC008-02318	2	4	5/4" (31.75mm)	1.4-3.6	9	DXV57 #14~#25	4000
NC008-02381	2	4	3/2" (38.1mm)	1.4-3.6	9	DXV57 #14~#25	4000
NC008-0464-254	4	8	1/4-1-1/4" (6.4-25.4-6.4mm)	1.4-3.6	9	DXV57 #14~#25	4000
NC008-04254	4	8	1" (25.4mm)	1.4-3.6	9	DXV57 #14~#25	4000
NC008-0464-254/HPR	4	8	1/4-1-1/4" (6.4-25.4-6.4mm)	1.4-3.6	9	DXV57 #14~#25	4000
NC008-0464-222/HPR	4	8	1/4-7/8-1/4" (6.4-22.2-6.4mm)	1.4-3.6	9	DXV57 #14~#25	4000
NC008-06064	6	12	1/4" (6.4mm)	1.4-3.6	9	DXV57 #14~#25	4000

PICOTING MACHINE

One / two needle picoting chainstitch machine

Z008

2

48

Q

機種別 Model

Z008 外曲牙縫紉機
Picoting
Chainstitch
Machine

針數

Needle numbers

1

2

針距

Needle Gauge

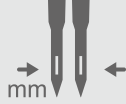

Z008-248Q

代碼
Code

型式
Type

車縫導片 / 壓具
Guide / Presser Foot

車縫樣式
Sewing Pattern

Q 雙鋸齒型
Double-Picot

ZB11-A

P7873-A



ZB09*

P7872-A*

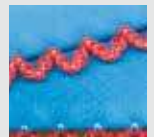

ZB09*

P7872-A*



* 備註：置於配件盒當中
*Remark: Parts marked with an asterisk included in the accessory box.



獨特的筒型台面設計使車縫更得心順手，更適於筒狀物的車縫，整體的外觀設計使操作與技術者的維修更容易

Cylinder machine frame design to make sewing operation easier for circular cloth. Easy maintenance and adjustment.



全自動加油系統，潤滑各部零件，提升機台壽命

Automatic oiling system to lubricate all spare parts, to extend the machine lifetime.



密閉式針杆及天秤結構，防止漏油

Entirely sealed needle bar and take-up design to prevent oil leakage.



按鈕式縫距調整裝置，簡便省時，減少一般式調整或更換零件之冗長作業

Stitch length adjustment by knob, saves time for adjustment and maintenance.

可更換不同規格元件，適合多樣的鋸齒飾邊或雙鋸齒飾邊

Different gauge set can be easily changed suitable for various picot sewing.

Z1

Z008-248Q

2

4

3.7-7.4

1

7

UO163 #11

3500

Z型裝飾

適用於女用內衣褲、手絹、桌布、禮服、童裝、運動裝、枕套等之各種裝飾縫

ZIGZAG SEWING

Suitable for making decorative zigzag stitches on women's underwears, handkerchiefs, tablecloths, formal dresses, children's wear, sportwears and pillowcases.

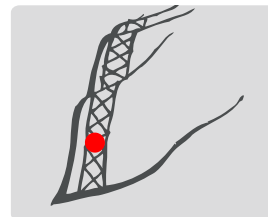

DEVICE



DV¹²

下軸型直驅伺服馬達 Lower main shaft type Direct-drive servo motor

多針鏈縫機模組化搭配直驅伺服馬達，多樣化的選擇，更有彈性

¹ = 廠商代碼 ² = 版本代碼 + 功能代碼

Double chainstitch machine equipped with the modularized direct-drive servo motors to be more flexible for diversification.

¹ =Manufacturer code ² =Version code + Function code

可自行組裝 self-installation : YES

適用機型 applicable model : 全系列多針鏈縫機 All Double Chainstitch Series

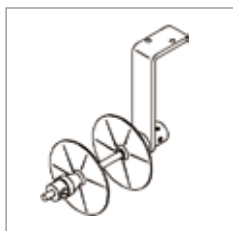

FH

下固定式送帶盤 Lower Fixed Tape Holder

置於桌下方放布條或鬆緊帶

Holds tape or elastic tape under the table

可自行組裝 self-installation : YES

適用機型 applicable model : VC008A/VWL, VC008A/VWLB, VC008A/VWLC, HF008A/HPR



JD

跳針裝置 Skip Stitch Device

避開褲腰車縫時不需下針的地方

Control freely to avoid stitches sewed on un-wanted working area.

可自行組裝 self-installation : NO

適用機型 applicable model : HF008A, NC008



LSA

上固定式送帶盤 Upper Fixed Tape Holder

置於上前方放布條或鬆緊帶

Holds tape or elastic tape in front.

可自行組裝 self-installation : YES

適用機型 applicable model : VC008(A/B)/VPL



RL

筒型衣物撐開滾輪組 Tubular Extending Roller

協助將筒型衣物撐開，便於車縫

Extends the tubular material to make sewing process easier.

可自行組裝 self-installation : YES

適用機型 applicable model : VC008(A/B)/VCE



VAD

氣壓式抬壓腳裝置 Pneumatic Presser Foot Lifter

利用氣壓提升壓具可提高效率

註: 1. 需有空壓設備 2. 搭配伺服馬達使用

Pneumatic presser foot lifter is used to improve operation efficiency.

Remark: 1. Compressor capability needed. 2. Servo motor needed.

可自行組裝 self-installation : YES

適用機型 applicable model : VC008A, VC008B



VAR

密縫裝置 Condense Stitching Device

於車縫起始或結束時進行密縫的功能，確保縫線不易脫落，提高車縫品質

Reinforce the stitches at the beginning and end of sewing, to enhance sewing sturdiness and quality.

可自行組裝 self-installation : NO

適用機型 applicable model : VC008A, VC008B



VCE

環型褲頭鬆緊帶上帶裝置 Tubular Elastic Inserting and Attaching

用於運動褲或男內褲等圓筒型衣褲上鬆緊帶包縫，本機型可有兩種縫合方式:

1. 環型鬆緊帶布料折邊縫
2. 拷克後上環型鬆緊帶包縫

Tubular elastic inserting on sportswears or man's underwears, two types of sewing functions are available:

1. To attach tubular seamless elastic waistband.
2. To cover sewing on elastic after overlock seaming.

可自行組裝 self-installation : YES

適用機型 applicable model : VC008A, VC008B



VCL(P)

後拉引滾輪 Rear Puller

協助車縫後平順，不會擠壓。與針位距離 72 mm，讓拉布與出布更穩定

註: 各機型搭配平輪或齒輪如下表，若有異於標準品訂購時請特別註明

Smooths the sewing process, and no shirr. The 72 mm distance from the needle helps to stabilize the fabric during sewing process.

Remark: Please check the type of pullers (flat or serrated) used for different machines from the table below. If you would like to order different pullers standard, please remark when ordering other than.

滾輪 / Roller	平輪 / Flat	齒輪 / Gear
上 / Upper	VCL16P	VCL37P(27T)
下 / Lower	VCL28	VCL33P(16T)
VC008(A/B)-04xxxP		S
VC008(A/B)-04xxxP/VCE		S
VC008(A/B)-04xxxP/VWL		S
VC008(A/B)-06xxxP/VPL	S	
VC008(A/B)-12xxxP		S
VC008(A/B)-12xxxP/VCE		S
VC008(A/B)-12xxxP/VPQ	S	
VC008(A/B)-12xxxP/VWL		S
VC008(A/B)-12xxxP/VPQ-K	S	

VCL滾輪明細表 VCL Roller List

Type	平輪 Flat Type		齒輪 Gear Type	壓花 Knurling
材質 Material	硬質塑膠 PU (Black)	軟質橡膠 Rubber (Black)	塑鋼 POM (White)	鋼質 Steel
長度 Length	80mm	80mm	80mm	78mm
上滾輪護蓋 Upper Cover	VCL39R	VCL39R	VCL39R	VCL39R
上滾輪 Upper	VCL16P	VCL16R	VCL08P(22T) 厚 Heavy	VCL08N (22T)
			VCL37P(27T) 中厚 Medium	
下滾輪 Lower	VCL28	VCL28R	VCL33(14T) 厚 Heavy	VCN33N(22T)
			VCL33P(16T) 中厚 Medium	
			VCL61(28T) 薄 Light	
			VCL64(32T) 輕薄 Fine	

滾輪選用原則 Puller Set Application

平輪 Flat type	塑膠 PU	適用一般薄布料，如梭織棉布 For common materials, eg: woven cotton fabric.
	橡膠 Rubber	適用貼帶車縫，或光滑薄布料使用，如梭織絲光布 For tap attaching or slippery materials, eg: woven silk fabric.
齒輪 Gear type	粗齒塑鋼 Big-teeth POM	適用鬆緊帶車縫，大折景 For elastic band sewing, big gathering
	細齒塑鋼 Fine-teeth POM	適用鬆緊帶車縫，小折景 For elastic band sewing, small gathering
鋼質壓花輪 Knurling Steel roller		適用牛仔類與厚布料 For jeans and heavy material

可自行組裝 self-installation : NO

適用機型 applicable model : VC008A, VC008B



VPQ

彈性線抽折縫裝置 Elastic Thread Shirring

適用於女用裙皺褶，連身衣裙等腰邊鬆緊帶皺褶均能順暢縫紉，勾針底線宜用彈性線
Suitable for sewing ornamental shirring on women's blouses. Suggested to use elastic thread for lower looper.

可自行組裝 self-installation : YES

適用機型 applicable model : VC008A-12048P, VC008A-12064P



VPQ-K

彈性線抽折縫裝置 Elastic Thread Shirring

適用於女用裙皺褶，連身衣裙等腰邊鬆緊帶皺褶均能順暢縫紉

1. 勾針底線宜用彈性線
2. 增加VWL組可穩定鬆緊帶的鬆緊度讓車縫更平順美觀，不跳針
3. 將彈性線安裝於桌板下，讓彈性線車縫更順暢
4. 本配件為多功能，可調為VWL，VPQ單一使用

Suitable for sewing ornamental shirring on women's blouses.

1. Suggested to use elastic thread for lower looper.
2. The added VWL set will further stabilize the tension of elastic thread and make sewing process more smoothly, also can avoid stitch skipping.
3. Holds the elastic thread under the table to make sewing process more smoothly.
4. Multifunction device can be adjusted to VWL or VPQ.

可自行組裝 self-installation : YES

適用機型 applicable model : VC008A-12048P, VC008A-12064P



VPL

貼帶裝置 Tape Attaching

主要用於襯衫門襟·腰帶·運動衣等裝飾條帶

註: 1.喇叭成品規格如圖表

2.布條之尺寸可依3/16"或1/4"倍數變換

Decorative tape for shirt-fronting, sportswears, waist band, etc...

Remark: 1. Folder and finished goods specifications as listed in the table below

2. Tape size can be adjusted in multiples of 3/16" or 1/4".

機型 Model	完成尺寸 Finished Size(mm)	X	Y	Z	針距 Needle Gauge	壓具 Presser Foot
VC008(A/B)- 06048P	8	B417P	B417AP	B417P	3/16"	P9412DA
	9	B417Q	B417AQ	B417Q		P9412D
VC008(A/B)- 06064P	10	B417R	B417AR	B417R	1/4"	P9512DA
	12	B417S	B417AS	B417S		P9512D
	16	B417U	B417AU	B417U	1/2"	P9512B

可自行組裝 self-installation : YES

適用機型 applicable model : VC008(A/B)-06048P, VC008(A/B)-06064P



VPS

彈性線抽折縫裝置 Elastic Thread Shirring

適用於女用裙皺褶·連身衣裙等腰邊鬆緊帶皺褶·如:女襯衫·游泳衣·婦女用衣物·枕頭套·兒童衫。針線用彈性線·勾針為勾線功能不穿線·為101車縫式樣

Suitable for sewing ornamental shirring on women's blouses, swimsuits, pillowcases, children's shirts. Needle uses elastic thread and looper without any thread. It's 101 sewing type.

可自行組裝 self-installation : YES

適用機型 applicable model : VC008A-12048P, VC008A-12064P



VWL VWLB VWLC

前鬆緊帶送帶滾輪裝置 Front Elastic Feeding

鬆緊帶送帶滾輪裝置能隨機台本身之運轉·將鬆緊帶送出·且可調整鬆緊帶送出量之多寡·操作簡便;車縫慢跑褲·運動褲·休閒褲等褲頭·由於前後導輪裝置·上鬆緊帶時能保持一定張力·維持車縫品質

註:VWL 附 B413 喇叭

VWLB 附 B411喇叭及撐開滾輪組

VWLC 附 VCE 導片

Length of elastic type can be easily adjusted by elastic feeding device, suitable for sports pants and casual pants. Roller maintains the tension of elastic thread and quality during sewing process.

REMARK: VWL with folder B413

VWLB with folder B411 and extending roller

VWLC with VCE fabric guide

可自行組裝 self-installation : YES

適用機型 applicable model : VC008A-04064P, VC008A-04085P, VC008A-04095P,
VC008A-04106P, VC008A-04127P, VC008A-12048P,
VC008A-12064P

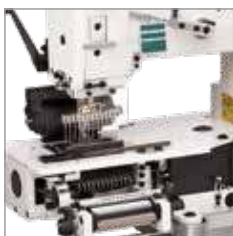

VSC

鬆緊帶抽皺縫裝置 Elastic Thread Shirring Sewing

彈性線直送不打線圈·由針線與勾針線上下包覆·車縫成品效果較VPQ薄·且皺褶可拉伸至完全平坦

Elastic thread is straight, not looped, which is fixed by needle thread and looper thread. The finish is thinner than VPQ and the shirring becomes flat as it is pulled extensively.



可自行組裝 self-installation : NO

適用機型 applicable model : VC008A-12048P, VC008A-12064P



VUT

自動切線裝置 Pneumatic Automatic Thread Trimmer

氣動式自動切線可提高車縫效率節省成本

Pneumatic automatic thread trimmer increases operation efficiency and saves the cost.

可自行組裝 self-installation : NO

適用機型 applicable model : VC008(A/B)-04085P, VC008(A/B)-12048P, VC008(A/B)-12050P, VC008(A/B)-12064P

VC008 彈性線機型對照/ VC008 Comparison on Elastic Thread Models

型號 Model	布樣 Sample Fabric	面線(針線) Surface Thread (NeedleThread)	底線(勾針線) Rear Thread (Looper Thread)	花樣線 Decorative Thread	備註 Remark
VPQ		一般 Standard	彈性線 Elastic	-	
VPQK		一般 Standard	彈性線 Elastic	-	車縫與VPQ完全相同 差別在多加VWL下送輪, 使底線控線穩定 Same stitch as VPQ. The difference is on the front roller, VWL, which stabilizes rear thread controls.
VPS		彈性線 Elastic	無 None	-	勾針不穿線 Looper without thread.
VSC		一般 Standard	一般 Standard	-	彈性線拉直,由底線與面線包 Elastic thread is stretched and covered by rear thread and surface thread.

TABLE

桌板代號 Item No.	尺寸 / Size (mm)			說明 Description	適用機型 Applicable Model	備註 Remark
	長 Length	寬 Width	厚 Thickness			
VC008-T1	1200	540	45	半沉式 Semi-submerged	VC008(A/B)-04 VC008(A/B)-04P/VCE, VUT	
VC008-T2	1200	540	45	上乘式 Non-submerged		開口型 Open type
VC008-T3	1200	540	45	半沉式 Semi-submerged	VCO08B-11, VCO08B(A/B)-12,VCO08A-13, VCO08(A/B)-06/VPL, VC008A-12/VPQ, VCO08(A/B)-12/VUT	
VC008-T4	1200	540	45	上乘式 Non-submerged		開口型 Open type
VC008-T5	1200	540	45	半沉式 Semi-submerged	VC008A-04/VWL, VWLB, VWLC	
VC008-T6	1200	540	45	半沉式 Semi-submerged	VC008A-12/VPQK, VWL	
VC008-T9	1200	540	45	半沉式 Semi-submerged	VC008A-12/VSC	
VC008-T10	1200	540	45	全沉式 Full-submerged	VC008(A/B)-04, VC008A-12	需搭配 SM899-A SM899-A set required
VC008-T25	1200	600	45	上乘式 Non-submerged	VC008(A/B) for SLA	
HF008-T1	1200	540	45	半沉式 Semi-submerged	HF008(A)	
HF008-T3	1200	540	45	全沉式 Full-submerged	HF008(A)	
HF008-T4	1200	540	45	半沉式 Semi-submerged	HF008(A)/FBQ	
Z008-T1	1200	540	45	半沉式 Semi-submerged	Z008	
Z008-T2	1200	540	45	上乘式 Non-submerged	Z008	開口型 Open type
NC008-T1	1200	600	45	上乘式 Non-submerged	NC008	開口型 Open type

ONE NEEDLE LOCKSTITCH MACHINE

DL7200C

-

B

M

1

A

-

16

機種別 Model

DL720 直驅單定針平縫車
Direct-Drive Needle Positioning
Lockstitch Machine

DL7200C 單步進電腦平縫車
Computerized Lockstitch
Sewing Machine With Single
Stepping Motor

DL7200D 雙步進電腦平縫車
Computerized Lockstitch
Sewing Machine With Double
Stepping Motor

DL7500 雙步進電腦觸控平縫車
Computerized Lockstitch Sewing
Machine with Double Stepping
Motor and Touch Panel

旋梭 Hook

- 1 高速縫梭頭
High Speed Hook
- 2 大旋梭
Large Hook

送布牙 Feed Dog

- 四排牙
4 Rows of Teeth
- A 三排牙
3 Rows of Teeth



功能選配 Function Option

功能碼 Function	快速倒縫 Reverse Feeding	拔線桿 Wiper	電子夾線 Thread	自動抬壓腳 Auto Lifter	防鳥巢 Bird Nest Prevention
11	V	V	-	-	-
12	V	-	-	V	-
13	V	V	-	V	-
15	V	-	V	-	-
16	V	-	V	V	-
17	V	-	V	V	V

特性 Features

- R 右切刀
Vertical Edge Trimmer
- B 旋轉式切線系統
Rotary Thread Trimming
- N 針送布
Needle Feed
- RN 右切刀針送布
Edge Cutter & Needle
Feed

車縫布料

Sewing Material

- L 薄布料
Light
- M 中厚布料
Medium
- H 厚布料
Heavy
- HM 中厚至厚布料
Medium & Heavy
- X 牛仔料
Jeans

DL720 SERIES FEATURES



DL720 直驅單定針平縫車 Direct-drive needle positioning lockstitch machine

- 機電一體化的完美整合，內置電控箱及控制台，安裝簡易，使用方便
- 直驅伺服馬達，反應快速，動作精準，比離合器馬達省電 60%
- 使用方便：配備 LED 照明，內置式繞線器，與補針功能
- Mechatronic integration with built-in control box and control panel. It is easy to install and operate.
- Direct-drive servo motor is speedy, accurate, and energy-saving than clutch motor by 60%.
- User friendly: Equipped with LED light, built-in bobbin winder, and half stitch function.

DL720	mm	mm	mm	Needle No. DB × 1	S.P.M. (Max)	選配桌板 Optional Table
M1	0-4	15.8	手動 Hand lifter 5.5mm 膝動 Knee lifter 13mm	#11~#14	4000	DL7000T-T1
H1	0-5	18.0		#18~#21	3500	
M1A	0-6.5	15.8		#11~#14	4000	

DL720 -RM1 直驅單定針帶刀平縫車 Direct-Drive Needle Positioning Lockstitch Machine & Edge Cutter



30mm 落料空間：
廢料從落料口自然滑落，每時每刻保持清爽乾淨。

30mm space:
30mm space for giving up the waste, it brings out with a clean working space.



黑金剛鍍層：
刀架導杆均採用 DLC 塗層處理，更耐用更耐磨。

Special black coating:
Cutter's stick is made with DLC coating which helps to increase durability.



簡易定針型可搭配喇叭組，進行布條滾邊車縫（喇叭為三折捲，入布寬度 28mm，出布寬度 8~10mm）

Needle position function models can equip with binders, to perform tape binding. (Binders are with 3 folders; entering width is 28mm, exiting width is 8~10mm for material.)

DL720	mm	Needle No. DB × 1	布料厚度 Fabric Weight			手動 Hand	自動 Auto	mm	S.P.M. (Max)	mm	KG
			L	M	H						
RM1	3.2 4.8 6.4	#14				4	10~13 (可調 Adjustable)	0~4	3700	L630 W245 H540	34.5 / 37.5

DL7200C SERIES FEATURES



DL7200C 單步進電腦平縫車 Computerized Lockstitch Sewing Machine With Single Stepping Motor

專利斜板自動式抬壓腳、搭載智能主板由核心精準控制針距，精度可達 0.1mm 的誤差。
智能控制作動行程、誤差，達到精準無聲倒縫。

Stepping motor controls stitch length and reverse stitch. It enables precision control over the stitch length to get an accuracy of 0.1mm and gives reverse stitches precisely on the top of the previous ones.

特點

FEATURES

- 【專利】斜板自動式抬壓腳：**
降低電磁鐵負載、耐用度提升
Patented inclined plane design of auto-presser foot lifter will lead to a significant increase of the electromagnetic service life and enhance its durability.
- 大風量手輪設計，高效率散熱**
Big hand wheel with cooling fan design improves the heat dissipation efficiency.
- 具備智能操控屏幕與USB接口**
Intelligent control panel with USB port
- 出廠預設9種花樣縫，也可彈性設定花樣，滿足多種縫紉需求**
Up to 9 standard sewing patterns for different needs and the sewing patterns can also be customized upon request.



規格

SPECIFICATIONS

DL7200C	mm — — — —	mm ! — — — —	mm ! — — — —			Needle No. DB×1	S.P.M. (Max.)	倒縫 Reverse Feeding	電子夾線 Thread Nipper	自動抬壓腳 Auto Lifter
BM1(A)-15	0~5 / A : 0~7	15.5	手動 Hand 5.5	膝動 Knee 13	自動 Auto 9	#11~#14	4500	V	V	—
BM1(A)-16	0~5 / A : 0~7							V	V	V
BH1(A)-15	0~5 / A : 0~7	18				V	V	—		
BH1(A)-16	0~5 / A : 0~7								V	V
BX2(A)-15	0~5 / A : 0~7	18				V	V	—		
BX2(A)-16	0~5 / A : 0~7								V	V

*A：表示針板、送具為三排齒 A：Needle plate, feed dog have three gears.
無：表示針板、送具為四排齒 None：Needle plate, feed dog have four gears.



DL7200C -RM1 單步進帶刀電腦平縫車 Computerized Lockstitch Sewing Machine With Single Stepping Motor & Edge Cutter

採用內置式直驅伺服馬達，實現了機器的快速啟動和制動的精確度；大幅度降低了噪音和振動，並降低了能耗，與普通的驅動裝置相比，電量耗減 35% 以上，適用於縫製各類襯衫、西服或類似服裝，特別是其衣領、前襟等部位，高速縫製時倒順送料針距能保持完全一致，側切刀裝置使縫紉和修刀工序一次完成，工作效率提高。



With built-in direct drive servo motor to achieve the accuracy of the machine's rapidstart-up and braking; a significant reduction in noise and vibration, and reduce energy consumption, compared with conventional drive unit, battery depletion of 35% or more, suitable for sewing various shirts, suits or similar garments, especially it's collar, breast and other parts, inverted send high-speed sewing material pitch to be completely consistent, side cutter device sewing and knife trimming procedures in one time efficiency.

特點

FEATURES

30mm 落料空間：
廢料從落料口自然滑落，每時每刻保持清爽乾淨。

30mm space:
30mm space for giving up the waste, it brings out with a clean working space.

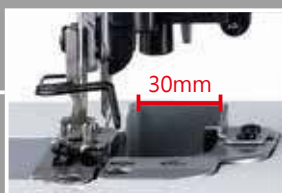

USB 介面：超能 USB 介面。

USB interface:
Versatile USB interface equipped.



1 倒縫步進電機驅動：
步進電機控制倒縫和針距，精確度達到 0.1mm，針距精準，重針度高，針距可鎖定，不會因為傳統標盤針距長久使用後導致針距忽大忽小。
Reverse sewing driven by stepping motor:
Stepping motor controls reverse sewing and needle movement. Actual precision can be as 0.1 mm. Needle gauge, which can be locked in, is precise with sewing repetition. It would not have the issue of unstable needle gauge using with traditional needle gauge device.

2 新靜界，新智縫：
採用步進電機驅動倒縫，加固，聲音輕，給你安靜舒適的工作環境。而且可實現鎖針，花樣加固縫等傳統結構無法實現的功能。
Quietness and Intelligence:
Manipulating the reverse sewing with stepping motor, it brings a calm environment. Other than traditional structure, it offers function of lockable needle and pattern sewing.

3 黑金剛鍍層：
刀架導杆均採用 DLC 塗層處理，更耐用更耐磨。
Special black coating:
Cutter's stick is made with DLC coating which helps to increase durability.



規格

SPECIFICATIONS

DL7200C	mm ↓	Needle No. DB×1	布料厚度 Fabric Weight			mm ↓	mm ↓	S.P.M. (Max)	mm ↓	KG ↓	
			L	M	H						手動 Hand
RM1	3.2 4.8 6.4	#14				4	10~13 (可調 Adjustable)	0~4	3700	L680 W250 H530	36 / 44
功能 Function	代碼 Function Code		自動切線 Auto trimming			倒縫 Reverse Feeding		自動抬壓腳 Auto Lifter			
	12		V			V		V			

DL7200D FEATURES

DL7200D 雙步進電腦平縫車 **Computerized Lockstitch Sewing Machine With Double Stepping Motor**



- 雙步進馬達驅動 · 實現完美的連貫動作
 - 起縫微鳥巢 · 結束短線頭 · 實現優美的車縫品質
 - 完整而優良的各項細節
-
- Double stepper motors drive for the perfect coherent movements
 - Starting with micro-bird nest, ending with short thread head, for the beautiful sewing quality
 - Complete and excellent details

特點

FEATURES

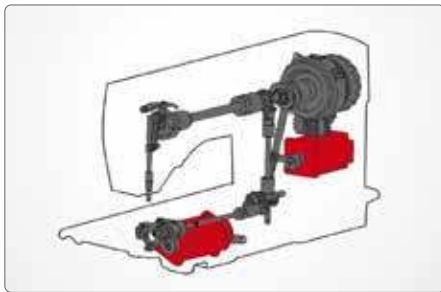

雙步進馬達驅動 · 實現完美的連貫動作

底部的步進馬達控制雙動刀切線與抬壓腳 · 右側的步進馬達控制針距與倒縫 · 以電控技術串聯每一個縫紉機功能 · 實現完美的連貫動作

Double stepper motors drive for the perfect coherent movements

The bottom stepper motor controls the double knives thread trimmer and presser foot lifter, and the right side stepper motor controls the stitch distance and reverse stitch. The computer control technology integrates every function of the sewing machine, and realize the perfect coherent movements.

起縫微鳥巢 · 結束短線頭 · 實現優美的車縫品質

完美的連貫動作 · 起縫時機針上只需極短線頭 · 大幅降低底面的鳥巢現象 · 穩定的雙動刀切線 · 可達 3 mm 以下的短線頭 · 實現優美的車縫品質

Starting with micro-bird nest, ending with short thread head, for the beautiful sewing quality

Due to the perfect coherent movements, it requires a very short thread head at the needle at the sewing starting, which significantly reduces the bird nest on the bottom side. The double knives thread trimmer is very stable, and it makes the ending with Max. 3 mm thread head, which realize the beautiful sewing quality.

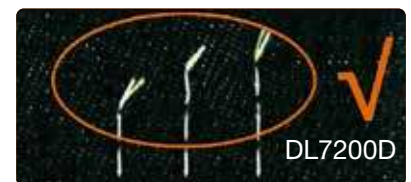

完整而優良的各項細節 Complete and excellent details

<p>照明與快速鍵三合一模組 Lighting and hot key 3-in-1 module</p>		<p>縫製多達 8 種不同線跡 Swing up to 8 different stitch patterns</p>	
	<p>電子膝控抬壓腳 Electronic knee touch presser foot lifter</p>		<p>密封油盤 Closed oil pan</p>
	<p>根據厚薄變化，智能提升壓腳 According to the thickness change, the intelligent presser foot</p>	<p>USB 充電埠 USB charging port</p>	

規格 SPECIFICATIONS

DL7200D	mm	mm	mm			Needle No. DB X 1	S.P.M. (Max)
BM1	0~5	15.5	手動 Hand 5.5	膝動 Knee 13	自動 Auto 9	#11~#14	4500
BM1A	0~7	15.5				#11~#14	4500
BH1	0~5	18				#20~#23	4000
BH1A	0~7	18				#20~#23	4000

功能 Function	代碼 Function Code	自動切線 Auto trimming	倒縫 Reverse Feeding	電子夾線 Thread Nipper	自動抬壓腳 Auto Lifter	防鳥巢 Bird nest prevention
	16	V	V	V	V	-
	17	V	V	V	V	V

DL7500 SERIES FEATURES



DL7500 雙步進電腦觸控平縫車 Computerized Lockstitch Sewing Machine with Double Stepping Motor and Touch Panel

本機採用一體式智能操作系統，配備 4.3 寸觸摸顯示屏，簡化操作邏輯，參數調整更加便捷。無軸承主軸伺服馬達、花樣米粒縫、包油盤、電子膝控、短線頭等功能，且送布、剪線、抬壓腳為步進電機驅動，穩定低噪音，功能齊全，質量穩定。

This machine adopts an integrated intelligent operating system, equipped with a 4.3-inch touch screen, which simplifies the operation logic and makes parameter adjustment more convenient. Special features includes bearing-less spindle servo motor, pattern stitch, sealed oil tank, electronic knee pad, short thread trimmer.

Feeding, thread trimming and presser foot lifting are driven by stepping motors, which is stable and quiet. Completed functions and stable quality.

特點

FEATURES

1 步進馬達電子針距控制技術： 實現倒縫與正縫針腳高度重合。

Stepping motor electronic stitch length control:
The stitch height of reverse stitching and normal stitching are aligned.

2 步進馬達雙向驅動技術（專利技術）： 一個馬達完成切線和抬壓腳動作。

Two-way stepping motor technology(patented):
One motor completes thread trimming and presser foot lifting.

3 短線頭： 採用電機驅動的雙動刀剪線機構，可在機針正下方完成剪線，縫紉後的線頭最短可達 3mm，可有效減少人工剪線的工作量。

Short thread head:
The shortest thread head is down to 3mm, which can effectively reduce workload of manual trimming.

4 花樣縫： DL7500 可以透過設定產生 8 種不同線跡。

Pattern stitch:
DL7500 stepping motor offers 8 different patterns.

5 低噪音： 優化的機殼設計和主軸馬達結構，機器運轉時噪音低；採用步進馬達控制加固縫，加固時無聲響；採用步進馬達控制抬壓腳，壓腳提升和下降時聲音輕柔；採用步進馬達驅動切線，切線聲音大幅度降低。

Low noise:
With optimized internal design and with stepping motor without bearing, DL7500 is quiet when reverse feeding, presser foot lifting, and trimming.

6 密封油盤設計： 避免油污造成的縫料污染，同時可減小整機運作時的噪音。

Oil tank design:
Sealed oil tank to avoid fabric from grease and to reduce noise when machine operates.

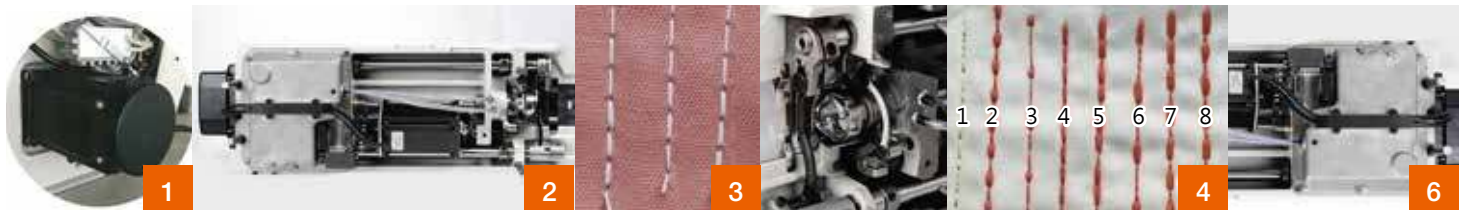

完整而優良的各項細節 Complete and excellent details

全新觸控顯示屏：
4.3 英寸彩色觸摸屏，內容直觀，操作方便



Advanced touch screen:
4.3-inch colored touch screen, intuitive and convenient.

四個按鍵：
配有四個補針鍵，方便進行加固、補針（補 1 針·補 1/2 針·1/4 針）倒縫操作。



Four buttons:
Equipped with four stitch compensation buttons, machine is convenient for reinforcement and stitch compensation (1 stitch, 1/2 stitch, 1/4 stitch) and reverse stitching operation.



黑金鋼針桿：
採用 DLC 塗層針桿，減少了頭部供油，顯著減少針桿漏油。

Needle bar made with black gold metal:
DLC coating helps to decrease the oil supply and to prevent the needle bar from oil leakage.

規格

SPECIFICATIONS

DL7500	Needle No.	布料厚度 Fabric Weight			mm		mm	S.P.M. (Max)	mm	KG
		L	M	H	手動 Hand	自動 Auto				
M	DB×1 #9 - #16				11	0~5	4500	L620 W280 H550	37.4 / 43.5	
H	DP×5 #18 - #21					0~7				

功能 Function	代碼 Function Code	自動切線 Auto trimming	倒縫 Reverse Feeding	電子夾線 Thread Nipper	自動抬壓腳 Auto Lifter	防鳥巢 Bird nest prevention
	16	V	V	V	V	-
	17	V	V	V	V	V

DL7500 -RNM1

雙步進帶刀針送電腦觸控平縫車 Computerized Needle Feed Lockstitch Sewing Machine with Double Stepping Motor and Touch Panel and Edge Cutter



本機通過針送布防止縫紉料的層移動和過骨的針跡堆積。調節操作簡便、設計精巧、省時省力、使縫製與切除縫料邊一次完成。採用步進馬達控制針腳長度、倒回縫、剪線無聲、可縫製 8 種不同線跡。適用於縫製各種服裝、男女襯衫、童裝、床單、窗簾等。

This machine uses needle feed system to prevent the layer movement of the sewing material and the accumulation of stitches passing through cross seam. The adjustment operation is simple, the design is exquisite, time-saving and labor-saving, and the sewing and cutting of the sewing material can be completed at one time. Stepping Motor-controlled stitch length, reverse sewing, silent thread trimming, and 8 different stitches can be sewn. Suitable for sewing all kinds of clothing, men's and women's shirts, children's garment, bed sheets, curtains, etc.

特點

FEATURES

- 1 無軸承主軸伺服馬達：**
直接使用主軸作為電機軸，無需用連軸器連接，主軸剛性好、力矩輕，電機運轉聲音輕。

Bearingless Spindle Servo Motor:

The main shaft is directly used as the motor shaft, and there is no need to connect with a coupling, the main shaft has good rigidity, light torque, and the motor has a light running sound.

- 2 步進馬達雙向驅動技術 (專利技術)：**
一個馬達完成切線和抬壓腳動作。

Two-way stepping motor technology(patented):

One motor completes thread trimming and presser foot lifting.

- 3 可離合式切刀開關：**
實現切布與非切布縫製功能切換。

Clutchable cutter switch:

Achieve the switching between cutting and non-cutting sewing functions.

- 4 花樣縫：**
DL7500 可以透過設定產生 8 種不同線跡。
Pattern stitch:
DL7500 stepping motor offers 8 different patterns.

- 5 高品質的加固縫線跡：**
步進電機控制針距與倒縫：針距精準、倒縫無噪聲；前、後加密縫功能有效縮短留在縫料上的線頭長度，防止線頭鬆散。

High-quality bartack stitches:

Stepper motor controls stitch length and reverse stitching: precise stitch length and noiseless reverse stitching; the front and back stitching functions effectively shorten the length of the thread left on the sewing material and prevent the thread from loosening.

- 6 電子膝控：**
比傳統機械膝控更加輕柔，減小操作負荷。

Electronic knee control:

Softer than traditional mechanical knee control, reducing operating load.

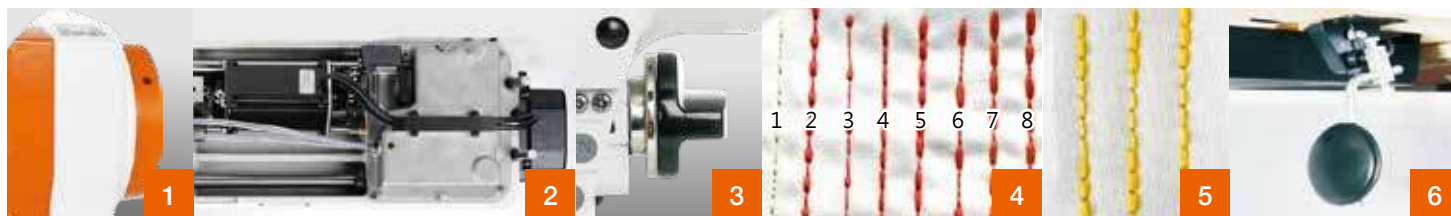

完整而優良的各項細節 Complete and excellent details

全新觸控顯示屏：
4.3 英寸彩色觸摸屏，
內容直觀，
操作方便



Advanced touch screen:
4.3-inch colored touch screen,
intuitive and convenient.

多功能補針開關：
可實現改變針距補針功能。



Multi-function needle compensation switch:
It can realize the function of changing stitch length to make up the needle.







針送料結構：
本機採用連桿式針送料結構，針送料方式使送料特性更加穩定，縫層之間不易產生滑移。

This machine adopts the connecting rod type needle feeding structure, the needle feeding method makes the feeding characteristics more stable, and it is not easy to slip between the seam layers.

規格

SPECIFICATIONS

DL7500		! Needle No. DB×1	布料厚度 Fabric Weight							
			L	M	H	手動 Hand	自動 Auto			
RNM1	3.2 4.8 6.4	#9 - #16				11	0~5	4500	L620 W280 H550	40 / 46

功能 Function	代碼 Function Code	自動切線 Auto trimming	倒縫 Reverse Feeding	電子夾線 Thread Nipper	自動抬壓腳 Auto Lifter	防鳥巢 Bird nest prevention
	16	V	V	V	V	-

TWO NEEDLE LOCKSTITCH MACHINE

DT828L

-

42

-

064

M

/

C

①機種別 Model

DT828 直驅雙針平縫車
Direct Drive Double
Needle Lockstitch
Sewing Machine

DT828L 雙步進雙針電腦平縫車
Computerized Double
Needle Lockstitch Sewing
Machine With Double
Stepping Motor

③針距 Needle Gauge



No.	mm	inch
032	3.2	1/8"
048	4.8	3/16"
064	6.4	1/4"

④車縫布料 Sewing Material

M 中厚布料
Medium

H 厚布料
Heavy

⑤自動切線 Auto Thread Trimmer

	機型 Machine Series	撥線 Thread Wiper	自動抬壓腳 Auto Lifer
C-13	DT828L	V	V

②功能 Function

規格 Sub-Class	針送 Needle Feed	標準旋梭 Standard Hook	大旋梭 Big Hook	倒縫 Reverse Feeding	角縫 Split Needle Bar
42	V	V	-	V	-
45	V	V	-	V	V
72	V	-	V	V	-
75	V	-	V	V	V

DT828 FEATURES



DT828 直驅雙針平縫車 Direct Drive Double Needle Lockstitch Sewing Machine

- 針送式送料，縫目準確，並可自由調整大小，縫目穩定美觀。
- 採用旋轉水平式旋梭，並附自動給油裝置。
- 附有檢視底線用的窗口，方便查看梭仔線的餘量。
- The design of needle feed mechanism moves with simple operation , excellent stitching and precise stitch-length.
- Adopting fully rotating horizontal axis hook , slide type thread take-up as well as automatically lubricating system.
- Convenient window for monitoring bobbin thread volume.



一般平縫
General plain seaming

特點

FEATURES



- 1 機電一體化的完美整合：
內置電控箱及控制台，安裝簡易，使用方便。
Perfect mechnronic combination:
Built-in control box & panel, easy to install and operate.
- 2 直驅伺服馬達：
反應快速，動作精準，比離合器馬達省電 60%。
Direct drive servo motor:
Quick reaction, precise movement, 60% energy saving compared to clutch motor.

3 倒縫撥桿裝置：
可以輕鬆實現倒縫縫紉。
Reverse lever:
Easy to achieve reverse.

4 縫距控制鈕：
轉動調整達到理想縫距。
Stitch length control button:
Rotate to get ideal stitch length.

5 簡易式操作面板裝置：
操作內容直觀，簡單方便。
Simple control panel:
User friendly, easy to operate.

6 邊角縫裝置：
從縫紉角度和針數決定距寬，來做到美麗之邊縫。
Split stitching device:
Decide the ideal width by sewing angle and stitches numbers, it will make good quality of split stitching.



規格

SPECIFICATIONS

DT828	mm	Needle No. DP×5	布料厚度 Fabric Weight			mm 手動 Hand	mm	S.P.M. (Max)	mm	KG
			L	M	H					
42	4.8 6.4	#14 - #22				7	M : 0~4 H : 0~5	3600	L730 W315 H670	49 / 52
45										
72							M : 0~7 H : 0~7	3000		
75										

功能 Function	規格 Sub-Class	針送 Needle Feed	標準旋梭 Standard Hook	大旋梭 Big Hook	角縫 Split Needle Bar
	42	V	V	-	-
	45	V	V	-	V
	72	V	-	V	-
	75	V	-	V	V

DT828L

FEATURES

DT828L

雙步進雙針電腦平縫車 Computerized Double Needle Lockstitch Sewing Machine With Double Stepping Motor



- 上軸採用通軸設計，整體力矩輕，機器運轉平穩，送料流暢。
 - 本機採用 750W 大功率伺服電機直接驅動，噪音低、震動小，安裝方便，啟動停車反應迅速，機針貫穿力強。
 - 雙步進驅動技術，實現縫、加固、剪線和抬壓腳無聲。
 - 密封式油盒設計，清潔無污染。
 - 電子膝控裝置，抬壓腳輕盈省力，降低勞動強度。
 - LED 照明燈亮度三檔可調。
 - 多鍵位操作面板，操作內容直觀，簡單方便。
 - 一體式背掛式電控，安裝方便。
- The upper shaft adopts the through-all design; the overall torque is light; the machine runs smoothly; and the feeding is smooth.
 - 750W high-power servo motor: larger needle penetration force, lower noisy, lower vibration, easier to install and shorter responding time.
 - Stepping motor with bidirectional driven technique: powerful, stable as well as quiet when end back-tacking, reinforced stitching, trimming, and presser foot lifting.
 - The sealed lubricate design: avoid fabrics from grease effectively.
 - Electronic knee control pad makes the foot lifter light and easy to operate.
 - 3-level LED light.
 - Multi-functional panel: intuitive and user-friendly.
 - Integrated back-mounted control box; easy to install.



- 1 步進馬達雙向驅動技術 (專利技術):**
一個馬達完成切線和抬壓腳動作。
可靠的切線機構：
切線機構採用步進馬達驅動，結構簡單、切線穩定、方便維護。

Stepping motor bidirectional driven technology (patent):
One step motor control trimming and pressing foot lifter work.

The unique thread trimmer device:
Adopt step motor to drive, stable, light noise and convenience on maintenance.

- 2 直刀剪線結構:**
直刀剪線機構，剪線穩定。
Straight knife system:
Straight knife thread trimming mechanism, stable thread trimming.

- 3 密封油盤設計:**
縫料清潔無污染。
The sealed lubricate design:
Effectively avoid the material dirty from oil.

- 4 多鍵位操作面板:**
操作盒按鍵內容直接，操作簡便迅速。
Multi-key operation panel:
The operation box has direct key content, and the operation is simple and rapid.

完整而優良的各項細節 Complete and excellent details



角縫車縫
Split needle bar sewing

多功能按鍵設置：
可以輕鬆實現轉角、
倒縫、密縫、補針等
縫紉。

一般車縫
General sewing

The multifunctional
buttons:
easy to achieve angle
change, reverse stitch,
seam stitch and stitch
compensation.

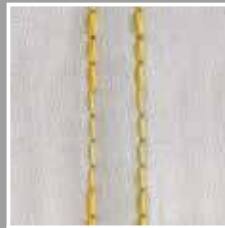

高品質的加固縫
線跡：
採用步進馬達控
制的送料機構，
精準控制送料行
程，任何針距下
都可以實現線跡
重合的加固縫。

High-quality reinforcement stitches:
Step motor can accurately control
the feeding, making reinforcement
available for any stitch length.

電子膝控：
不改變工人的操
作習慣實現輕鬆
抬壓腳。



Electronic knee pad:
Without worker changing oper-
ating habits, presser foot can be easily
lifted.

規格

SPECIFICATIONS

DT828L	mm	Needle No. DP×5	布料厚度 Fabric Weight			mm	mm	S.P.M. (Max)	mm	KG
			L	M	H					
42	3.2 4.8 6.4	#11 - #16		■		7	8-12 (可調 Adjustable)	3000	L680 W290 H640	55 / 62
45				■						
72		#14 - #22		■						
75				■						

功能 Function	規格 Sub-Class	針送 Needle Feed	標準旋梭 Standard Hook	大旋梭 Big Hook	倒縫 Reverse Feeding	角縫 Split Needle Bar
		42	V	V	-	V
	45	V	V	-	V	V
	72	V	-	V	V	-
	75	V	-	V	V	V

DT828 Series	③ mm	mm			Needle No. DP×5	mm	S.P.M. (Max)		倒縫 Reverse Feeding	撥線桿 Wiper	自動抬壓 腳 Lifter	角縫 Split Needle Bar
		手動 Hand	膝動 Knee	自動 Auto								
DT828-42-③M	048 064	7	10	-	#14	0~4	3600	Direct- drive AC Servo motor	√	-	-	-
DT828-42-③H					#22	0~5	3000		√	-	-	-
DT828-45-③M					#14	0~4	3000		√	-	-	√
DT828-45-③H					#22	0~5	3000		√	-	-	√
DT828-72-③M			10		#14	0~7	3000		√	-	-	-
DT828-72-③H			13		#22	0~7	3000		√	-	-	-
DT828-75-③M			10		#14	0~7	3000		√	-	-	√
DT828-75-③H			13		#22	0~7	3000		√	-	-	√
DT828L-42-③M/C-13	032 048 064	-	8-12	#11~#16	0~4	3000	√	√	√	-		
DT828L-42-③H/C-13				#11~#16	0~5	3000	√	√	√	-		
DT828L-45-③M/C-13				#11~#16	0~4	3000	√	√	√	√		
DT828L-45-③H/C-13				#11~#16	0~5	3000	√	√	√	√		
DT828L-72-③H/C-13				#14~#22	0~7	3000	√	√	√	-		
DT828L-75-③H/C-13				#14~#22	0~7	3000	√	√	√	√		

* 028,032,040,048,064,079,095,127,159,191,222,254,381

TABLE

桌板代號 Item No.	尺寸 / Size(Mm)			說明 Description	適用機型 Applicable Model
	長 Length	寬 Width	厚 Thickness		
DL7000T-T1	1200	540	40	全沉式 Fully-submerged	DL720, DL7200C, DL7200D, DL7500
DT828L-T	1200	535	40	半沉式 Semi-submerged	DT828L
DT828-T	1200	545	40	半沉式 Semi-submerged	DT828

PS SERIES

Direct-drive Programmable Electronic Pattern Sewing Machine 直驅可程式電子花樣機



特點

FEATURES

新一代伺服步進驅動技術

馬達運行更精準，長時間工作狀態下，馬達溫升低，回應速度更快

New Generation Servo-stepping driving technology

The motor runs more accurately, and the response speed is faster. The temperature rises lower under long working conditions.

採用高階直驅馬達

最高速度達到2800 S.P.M.，生產效率進一步提高，起動與停車反應迅速，與傳統型相比縮短19%，提高生產效率，耗電低，經濟實用，與傳統型相比減少50%

High quality direct-drive servo motor

As the maximum speed reaches 2800 S.P.M. so the production efficiency is more improved. The start / stop response is rapid, which is 19% shorter than the conventional type. Low power consumption makes it economy and practical, which is 50% lower than the conventional type.

以0.05mm的最小解析度實現美觀的縫紉線跡

每脈衝0.05的高解析度，PS系列可縫製出滑順的曲線，並且可做簡單的繡花圖案，就連一般刺繡機很難勝任的厚面料刺繡也可完成

The min. resolution 0.05mm realizes perfect sewing quality.

With a high resolution of 0.05 per pulse, PS series can make a smooth curve, and a simple embroidery pattern. Even a thick fabric embroidery is available, which is difficult for a typical embroidery machine.

標配斷線感測器

發生斷線時，可偵測並立即停機，報警提示

Thread breaking sensor is standard equipped

When it happened thread breaking, the machine senses the problem and then stop with alarm.

可選配數碼夾線器

傳統方式以手感調整面線張力，配備數碼夾線器可以數位化設定，實現穩定的縫製品質

**Digital thread nipper is optional**

Adjusting the upper thread tension with human feeling is the old way. With the digital thread nipper can be set easily to realize the stable sewing quality.

裁片定位簡單準確

馬達驅動式抬壓腳 (S type)的行程，可選擇設定為1步或2步下降

Sewing material setting is easy and accurate

Motor-drive type presser foot (S type) can be set the stroke as 1-step or 2-step.

均勻穩定的收線

在低張力下，可以穩定收線，由於中壓腳的高度可以改變，即使面料厚度有段差的變化，也可保持適當壓力，確保均勻穩定的收線效果

Stable and uniform seam tightness

Under low tension condition, the seam tightness can be stabilized. Because the height of the intermediate presser can be changed, even if the thickness of the fabric changes as a step, the proper pressure can be maintained to ensure a uniform and stable seam tightness.



搭載WIFI功能，與生產管理系統快速對接，即時傳輸設備的縫紉資料
支持多種媒體，搭載1個SD卡插槽、2個USB埠

Built-in WIFI function for easy connection to production management system and sewing data real-time transmission.

Multi-data input with 1 SD card slot and 2 USB ports.

使用“NS600”程式設計軟體

可快速簡便的編輯花樣，更可相容“VDT、SEW”等格式花樣，修改花樣更簡便，可根據圖示和命令，輕鬆創建縫紉資料

NS600 pattern editing software

Easy pattern editing by computer. VDT, SEW, and the other format compatible.



- 程式編程畫面，使用說明圖示，可輕鬆創建縫紉程式

Pattern editing panel with instruction for easy creating your sewing patterns.

- 簡潔的縫紉資料修改區，可快速修改花樣圖形準確實現需要的縫紉資料

Compact sewing data tuning area for quick modification.

- 功能區選擇介面，圖形化顯示，便於使用者選擇

Function selection area with graphical display for user friendly.



- 直觀顯示縫紉資料，無需調取其他介面查看

Intuitive display of sewing data without changing the page.

- 資料讀入讀出簡單快捷，一鍵完成

Input and output easily.

配件

DEVICE



MY 帽沿
Cap brim



HM 快速換模
Template fast changing



KX 開口袋
Pocket welting

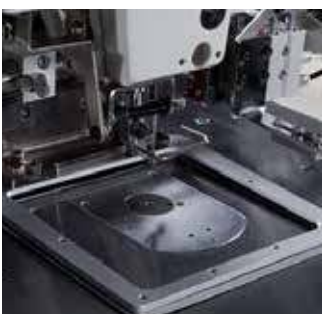

SS 側移壓腳
Side shift clamp



FZ 反轉壓腳
Inverted Clamp



規格

SPECIFICATION

PS-1010A-01S
 PS-1010A-01A
 PS-1010A-01A/SS
 (100 X 100 mm)
 PS-1310A-01S
 PS-1310A-01A
 (130 X 100 mm)
 PS-1510A-01S
 PS-1510A-01A
 (150 X 100mm)



PS-2210A-01A
 (220 X 100mm)
 PS-2516A-01A
 (250 X 160mm)



PS-3020A-01A
 PS-3020A-01A/HM
 PS-3020A-01A/MY
 (300 X 200 mm)
 PS-3525A-01A
 (350 X 250 mm)
 PS-4030A-01A
 (400 X 300 mm)

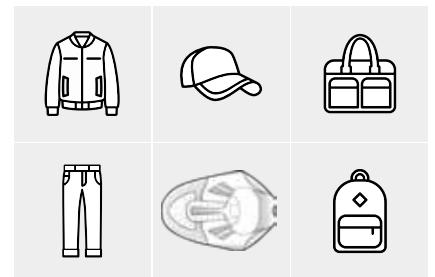

PS-2210AL-01A
 (220 X 100 mm)



PS-6040A-01A
 (600 X 400 mm)

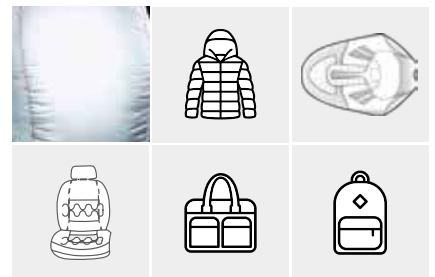

規格 Specification	1010A-01S	1310A-01S	1510A-01S	2210A-01A	2516A-01A	3020A-01A	3525A-01A	4030A-01A	6040A-01A
	1010A-01A	1310A-01A	1510A-01A	2210A-01A/KX		3020A-01A/HM			
	1010A-01A/SS			2210AL-01A		3020A-01A/MY			
線跡 Stitch Type	單針鎖縫 Single Needle Lockstitch								
最高縫製速度 Max. Sewing Speed	2800 S.P.M.								
縫製區(X x Y) Sewing area (X x Y)	100 X 100	130 X 100	150 X 100	220 X 100	250 X 160	300 X 200	350 X 250	400 X 300	600 X 400
送布方式 Feeding	間歇性送布 (步進馬達驅動) Intermittent Feeding (Stepping motor drive mode)								
針距 Stitch length	0.05~12.7 mm								
最大針數 Max. stitch	20,000 針/ 圖形 20,000 stitch / pattern								
壓腳驅動方式 Work Clamp Drive	S: 步進馬達驅動 A: 氣動式 S: Stepping motor drives A: Pneumatic drive			氣動式 Pneumatic drive					
壓腳上升量 Work Clamp Lift Amount	S: Max. 25 mm A: Max. 30 mm			Max. 30 mm					
兩步壓腳 2-step work clamp	S: 左右一體式 A: 左右分離式 S: Integrated-type A: Separate-type			左右分離式 Separate-type				左右一體式 Integrated-type	
間歇壓腳上升量 Stepping Presser foot Height	22 mm								
間歇壓腳行程 Stepping Presser foot Stroke	0 或 2~10mm (出廠預設3mm) 0 or 2~10mm (Default setting 3mm)								
旋梭 Hook	半回轉2倍梭 Double Capacity Shuttle Hook								
掃線 Thread Wiper	標配 Standard								
切線 Thread Trimmer	標配 Standard								
數碼夾線器 Digital Tension	選配 Optional								
斷線感測器 Thread Breakage Detector	標配 Standard								
外部資料儲存 External Data storage	經由 USB 埠 Inputted by USB Port								
馬達 Motor	直驅式 AC 伺服馬達 750W Direct-drive AC Servo Motor 750W								
電源 Power	單相 220V, 三相 380V Single Phase 220V, 3-Phase 380V								
重量 Weight	機頭: 88 kg, 電控箱: 14~16kg Machine Head: 88 kg, Control Box: 14~16kg			機頭: 166 kg, 電控箱: 14~16kg Machine Head: 166 kg, Control Box: 14~16kg	機頭: 174 kg, 電控箱: 14~16kg Machine Head: 174 kg, Control Box: 14~16kg		機頭: 184 kg, 電控箱: 14~16kg Machine Head: 184 kg, Control Box: 14~16kg	機頭: 224 kg, 電控箱: 14~16kg Machine Head: 224 kg, Control Box: 14~16kg	
氣壓/ 用風量 Air Pressure/ Consumption	0.5MPa 1.7L /min								

BT SERIES

Electronic High-speed Lockstitch Bartacking / Button Sewing/ Small Area Pattern Sewing Machine

BT 430 Q - 01

機電一體
Mechatronic

機種別 Model
430 套結 Bartacking
438 釘扣 Button Sewing
439 立扣 Shank Button
530 兩用型 套結/釘扣 2-in-1 Bartacking/ Button
630 小型花樣機(80X60) Small Pattern Sewing (80X60)

車縫應用 Sewing Application
01 標準 Standard
02 厚料 Heavy Material
03 帽眼 Radial Tacking
05 褲耳 Belt Loop
06 鬆緊帶拼接 Elastic Band Joining
07 針織 Knits Material

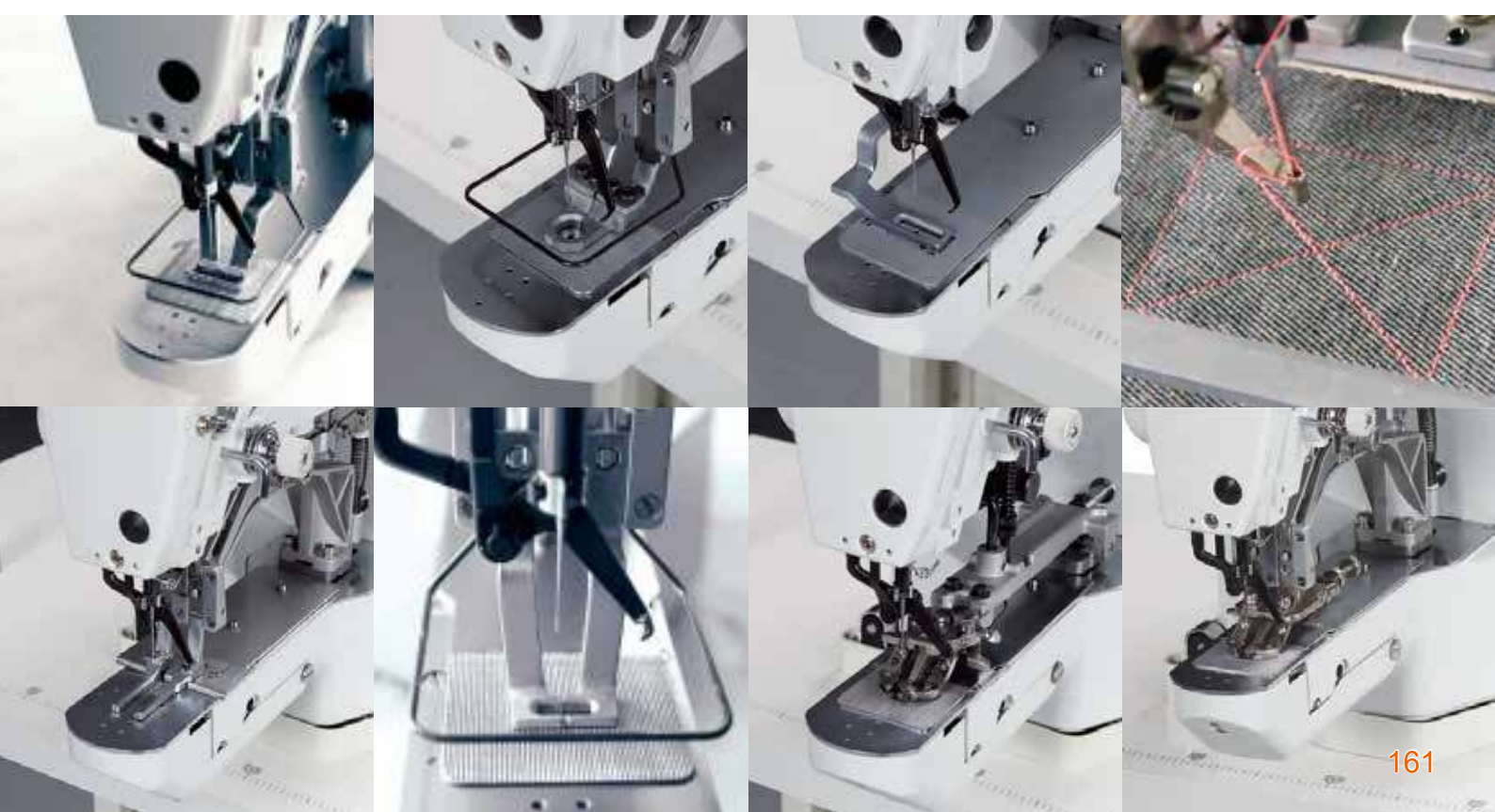

無油機構設計

採用DLC 針棒·挑線機構軸承設計·以固態油脂潤滑·有效防止面料油污問題

Oil-free Mechanism Design

With DLC needle bar, thread take-up lever's bearing design, and grease lubrication, it avoids the problem of oil stain.

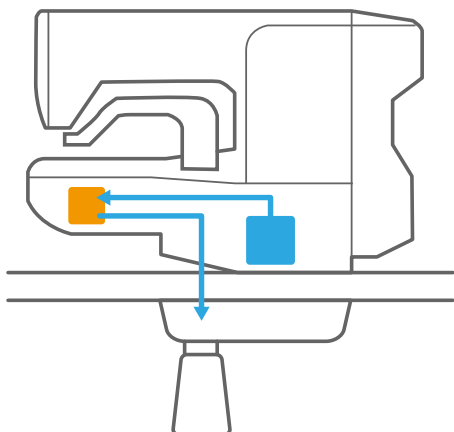
**雙踏板模式**

支援雙踏板操作模式·縫製特殊產品時·定位更容易

Dural Pedal Mode

Support double pedal mode for special sewing operation. It makes the material positioning easier.

**均勻的大壓腳壓力**

可對大壓腳角度進行調節·使得四周壓力均衡·確保縫製物穩定

Dural Pedal Mode

Support double pedal mode for special sewing operation. It makes the material positioning easier.

**操作面板內建USB埠**

以USB 記憶體進行圖形資料儲存·方便快速

Control Panel with Built-in USB port

It is easy and convenient for Pattern input by USB memory

**適用範圍大**

中厚料規格·可以改進挑線行程·提高線跡穩定度·擴大厚料縫製性能

Wider Range of Sewing Application

For heavy material, with thread take-up lever's stroke changing, it makes the stitches stable and upgrades the sewing performance.

**短線頭設計**

改進切線結構·在針孔最近點線·使餘線長度變短·減少修線工作

Short Thread End Design

Improving the thread trimming mechanism to cut the thread at the nearest spot from the needle. It shortens the thread end and reduces the finishing job.

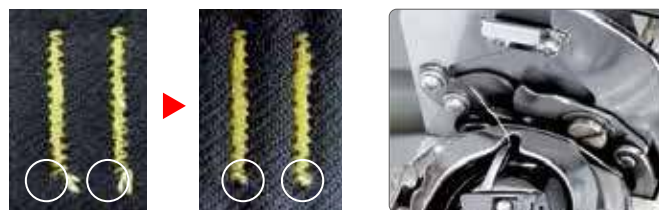
**BT630Q****均勻穩定的收線**

由於間歇壓腳提升量可以改變·當裁片厚度變化時·不會產生壓力過大或不足的問題·確保在低張力下仍可穩定收線

Consistent and Stable Thread Tightness

As the stepping presser foot's height can be changed, no problem of excessive or insufficient pressure with the sewing material thickness changing, it makes the stable thread tightening.



BT430Q-01 / 02

01 標準
Standard

02 厚料
Heavy material



BT430Q-03

帽眼
Radial tacking



BT430Q-05

褲耳
Belt loop



BT430Q-06

鬆緊帶拼接
Elastic Band Joining



BT430Q-07

針織
Knits material



BT438Q

釘扣
Button sewing



BT530Q

兩用型 套結/釘扣
2-in-1 Bartacking/ Button sewing

出廠時為套結機，釘扣套件附在配件盒中，用戶可以操作面板切換車縫模式

Bartacking is the standard setting, while the button sewing kit is included. Customer can change the sewing mode by control panel.



BT630Q

小型花樣機(80X60)
Small Area Pattern Sewing (80X60)



代號 Code	BT430Q						BT439Q	BT438Q	BT530Q	BT630Q
	01	02	03	05	06	07				
用途 Application	標準 Standard	厚料 Heavy material	帽眼 Radial tacking	褲耳 Belt loop	鬆緊帶拼接 Elastic Band Joining	針織 Knits material	立扣 Mushroom button sewing	釘扣 Button sewing	兩用型 套結 / 釘扣 2-in-1 Bartacking/ Button sewing	小型花樣機 Small Pattern Sewing
最高縫製速度 Max. Sewing Speed	3200 S.P.M.						2700 S.P.M.		3000 S.P.M.	
縫製區域 (X x Y) Sewing area (X x Y)	40X30	40X30	15X15	40X30	9X40	40X30	6.4X6.4		40X30	80X60
鈕扣尺寸 Button Size	間歇性送布 (步進馬達驅動) Intermittent Feeding (Stepping motor drive mode)						12mm	8~30mm		
送布方式 Feeding										
針距 Stitch length	0.05~12.7 mm									
最大針數 Max. stitch	5000 針 / 圖形 5000 stitch / pattern									
抬壓腳 Presser foot lifter	步進馬達驅動 Stepping motor drives									
壓腳 / 鈕夾上升量 Height of Presser foot/ Button clamp Lifting	Max. 17mm						Max. 13mm		Max. 17mm Max. 13mm	Max. 17mm
旋梭 Hook	半旋轉標準旋梭 Standard Shuttle hook									
外部資料儲存 External Data storage	經由 USB 埠 Inputted by USB Port									
循環縫 Cycle program	最多30 組, 每組上限50個步驟 Max. 30 sets, each set includes Max. 50 steps.									
記憶容量 Memory Capacity	內建 89種圖形, 最多可追加 512種圖形 / 500,000針 Built-in 89 patterns, Max. 512 patterns / Max. 500,000 stitches can be added.									
馬達 Motor	直驅式 AC伺服馬達 550W Direct-drive AC Servo Motor 550W									
電源 Power	單相 220V Single Phase 220V									
重量 Weight	機頭: 約 57 kg, 操作面板: 約 0.4 kg, 控制箱: 約 9 kg Machine Head: about 57 kg, Operation Panel: about 0.4 kg, Contro Box: about 9 kg									

Accurate sewing based on sewing data

先進電子技術精確控制，生產效率與縫紉品質得到高水準提升

BH-9820 SERIES

電子圓頭鎖眼機

Direct-drive Programmable
Electronic Eyelet Button Holer



BH-9820-00

BH-9820-01

BH-9820-02

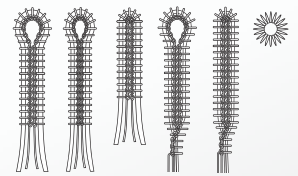

特點

FEATURES

1 改良氣缸

優化改進的可攜式氣管介面，隨插即用，用戶外接氣源更簡便

Improved cylinder

Improved pipe port to make connection much easier.



- 2 特殊工藝加工處理的齒輪和凸輪，大幅度降低了機器噪音及震動，經過科學的實驗測試，噪音比歷史資料降低了8-10個分貝，操作工的舒適度大大提升**

Special process processing of gears and cams,a significant reduction in the machine noise and vibration,after a scientific experimental test,the noise than the historical data reduced by 8-10db,the operator's comfort greatly improved.



3 精確調整簡單易行

切刀間隔和切刀位置補正等精確調整可在液晶顯示幕的操作盤上進行。專案以圖示顯示，操作人員無需閱讀也可直觀地進行操作

Easy adjustment

The position and adjustment of cutting knife can be adjusted by operate panel.All these adjustments will be showing in the operate panel in image.

4 提高了圖案的精確性

採用了伺服控制的送布裝置提高了剛性，因此可縫製出高精度圖案，即便高速縫紉或縫製重物時，也不會產生電子縫紉機常有的失調偏位。伺服控制還免去了初始位置的檢測

Making the accurate pattern

The machine controlled by servo system,it makes the patterns accurate even in high speed stitching.servo control system avoid the initial position checking.



5 減少跳針

優化彎針形狀·挑線量和其他零件。無論使用何種類型的線·由於線張力的改變而引起的跳針和針腳不夠緊密的情況都減少了·使縫紉能力得到擴張

Reduce skip stitch

Improved the looper and thread take-up, machine can stitch different fabric with different thread.

縫紉能力擴展圖

Sewing capacity expansion picture

(面線張力 / Tension force of stream thread)

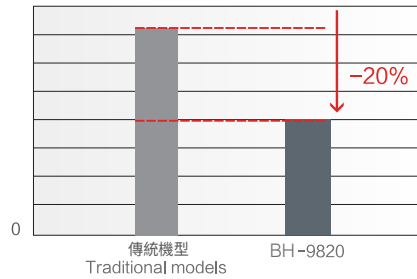

3.0mm寬度之字縫·縫紉後裁剪
2塊聚酯纖維(其中一塊的一側有夾層)
紡線：# 40
底線張力：30g
縫紉速度：2,500 S.P.M.

3.0mm-wide zigzag sewing, after-sewing cutting.
2 pieces of polyester serge (one side of one piece has a layer).
Span thread : # 40
Tension force of end thread : 30g
Sewing speed : 2,500 S.P.M.

6 短切面線及底線剪線器的特殊規格 (-02)

-02 規格中·單機支援較大範圍的應用·從休閒褲的平頭扣眼加固縫到牛仔褲的流線扣眼加固縫。該規格的縫製長度範圍為：18-26 mm

special specification of thread trimmer for -02 model

The machine model -02 can stitch big size pattern for both casual pants and jeans.the length of eyelet button hole can be 18-26mm.

8 操作簡單的操作盤

BH-9820 帶有液晶顯示幕(LCD)·並以圖示和文字顯示·設置或查看圖案以及更改縫製模式時·便於理解並易於操作

Easy operation

BH-9820 has liquid crystal display (LCD), supported by icon and character display. When setting or checking pictures and changing sewing mode, it is easy to understand and operate.



7 以圖示和文字顯示便於理解

The display of icons and characters makes it easy to understand



多語言顯示 Multi-language display

功能拓展

FUNCTION EXTENSION



應用實例

APPLICATION EXAMPLE



規格 Specification	BH-9820-00	BH-9820-01	BH-9820-02
面線剪線裝置 Needle thread trimmer	長線剪切 Long thread trim	長線剪切 Long thread trim	短線剪切 Short thread trim
底線剪線裝置 Bobbin thread trimmer	無 None	長線剪切 Long thread trim	短線剪切 Short thread trim
主要用途 Main applications	女裝 Suit-dress	男裝、休閒裝 Men's clothing, casual clothing	牛仔褲、褲裝 Jeans trousers, trousers
其他用途 Other applications	男裝、休閒裝、牛仔褲、褲裝 Men's clothing, casual clothing, jeans trousers, trousers	女裝、牛仔褲、褲裝 Suit-dress, jeans trousers, trousers	—
功能 Function	剪線裝置僅剪切面線。 可縫紉最長為50mm的扣眼。 Only trim the needle thread. The max. Length of button hole is 50mm;	剪線裝置將較長地剪切所有線頭。 在縫紉持續過程中可在更長距離內安全把握線尾。 Trimming both needle thread and bobbin thread	剪線裝置將較短地剪切線頭。 這樣可省去動手。 Trimming both needle thread and bobbin thread. No need second trim
縫製形狀 Sewing shape			
縫紉長度 Sewing length	圓頭鎖眼 8-50mm 直形鈕孔 8-50mm Round-head eyehole 8-50mm Straight button hole 8-50mm	圓頭鎖眼 8-42mm 直形鈕孔 5-42mm Round-head eyehole 8-42mm Straight button hole 5-42mm	22-30mm* 14-22mm* 18-26mm* 26-34mm* 34-42mm*
壓腳長度(標準) Press foot length (standard)	30mm		30/26mm
刀墊長度(標準) Length of hammer (standard)	22mm		24/20mm
刀墊長度(附件) Length of hammer (accessory)	30mm		28/24mm
縫紉速度 Sewing speed	1000-2500 S.P.M.		
針碼 Needle code	0.5-2.0mm		
之字縫寬度 Zigzag sewing width	1.5-5.0mm (在機械條件下最寬為4.0mm之字縫寬度補償最多為5.0) 1.5-5.0mm (In mechanical conditions, it is 4.0mm wide at most and the zigzag sewing width is 5.0 At most.)		
之字縫寬度(出廠設置) Zigzag sewing width (factory setting)	2.5mm		3mm
流線加固縫長度 Length of stream thread	0-20mm		
壓腳高度 Height of work clamp	標準高度為12mm(最高可達16mm) Standard height is 12mm (may reach 16mm at highest)		16mm
啟動方式 Start-off mode	雙踏板開關 Double pedal switch		
送布裝置 Fabric feeding device	三個步進馬達的間歇送布 (x,y,θ) Intermittent cloth-sending of 3 stepping motors (x,y,θ)		
機針*4 Machine needle 4	DOx558 Nm80 - Nm120		
安全設備 Safe setting	若有問題發生，有緊急停止功能和由安全電路驅動的內置自動停止設備 If there are any problems, the inner setting with urgent stop function and driven by safe circuit will automatically stop the machine		
上軸馬達 Upper shaft motor	AC伺服馬達550W AC-servo motor 550W		
空氣壓力 Air pressure	主調整器：0.5Mpa; 錘壓調整器：0.4Mpa Main regulator : 0.5Mpa; Hammer-pressure regulator : 0.4Mpa		
空氣消耗量 Air consumption volume	43.2升/分鐘(8周/分鐘) 43.2 liter/minute (8 cycles/minute)		
電源 Power supply	單相 100V / 200V, 三相 200V / 220V / 380V / 400V, 400VA Single phase 100V / 200V, Three phases 200V / 220V / 380V / 400V, 400VA		
重量 Weight	機頭：≈ 120kg / 操作盤：≈ 0.6kg / 控制箱：14.2-16.2kg Machine head: ≈ 120kg / Operation board : ≈ 0.6kg / Control box : 14.2-16.2kg		

LBHS-1790D Series

Computer-controlled, High-speed, Lockstitch Buttonholing Machine 高速電子平頭鎖眼機



應用範圍

APPLICATIONS

採用新型旋梭，實現美觀線跡效果。高效節能、舒適縫紉！

Machine with the new type rotary hook gives smooth operation and maximize sewing work efficiency!

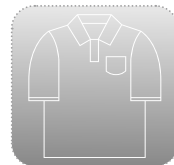

特點

FEATURES



三角縫 Purl stitch 平縫 Whip stitch

採用新型旋梭，防止斷線，收線不良等縫紉跟問題。低張力線跡美觀，三角縫和平縫都能很好呈現。

The new type rotary hook helps to prevent thread breaks, uneven winding and other related issues. With low tension, machine makes a quality finish for purl stitch and whip stitch.



代表性的縫紉圖案
Standard and round end patterns

細小圖案也能呈現美觀的線跡。Beautiful stitches even in small patterns. 針擺最小分辨率每個脈衝提高0.05mm，防止切刀後切開部位起毛。各種縫紉圖案都能準確縫製。Achieve minimum resolution of needle zigzag with 0.05 increment to prevent thread with fraying ends. It is capable to work on different type of sewing patterns.

四種打底縫紉形狀 Four types of underlay patterns

1



有效防止面料的鬆弛，保持線跡的柔軟性同時，提高扣眼的強度。

This type of underlay stitch is effective in preventing seams from unraveling and giving extra strength on buttonhole stitches.

矩形 Rectangle

2



有效防止面料的鬆弛，防止打結部位的褶皺產生，有效防止脫線。

The type of underlay stitch is effective in preventing seams from unraveling and preventing seam puckering.

山行 Mountain line

3



有效防止脫線，可以在矩形或山行後使用。

This type of underlay stitch is effective in preventing seams from unraveling and used after rectangle and mountain line underlay stitches.

交叉縫 Cross seam

4



鎖眼線跡形成前事先縫合開孔部位，事先壓平起毛面料的絨毛，使扣眼外觀更美觀。





Zig-zag underlay stitch gives an extra support to the buttonhole area before stitching and cutting to make a nice and beautiful buttonhole.

之字形 Zigzag



規格

SPECIFICATION

型號 Model	用途 Application	 mm	 DP×5	 mm	 S.P.M. (Max)	縫製區域 (X×Y) Sewing area (X×Y)	 KG
LBHS-1790DS	標準品 Standard	6.4~31.8mm	#11 - #14	34.6	4200	X:5mm, Y:41mm (選配件最大可縫製 Max.Y:120mm) (Y:120mm is max for optional device)	100.5kg / 106kg
LBHS-1790DK	針織布 For Knit						
標準縫紉圖案 Number Of Standard Patterns						21	
存儲圖案數 Max. Number Of Stored Memory Patterns						50	
最大針數 / 1 個程序 Max. Number Of Stitches Per Program						999	
數據存儲方式 Data Storage Method						經由 USB 埠 USB port	
電源 Power Supply						單相 Single-phase 110V/220V 三相 Three-phase 220V/380V	

LKS-1900D Series

Computer-controlled, High-speed, Lockstitch, Bartacking Machine 高速電子平頭套結機

- 精工品質·智慧高效·性能出色。
- 電控與機頭一體式設計·安裝更便捷。
- 全新操作面板·調用圖案便捷·圖案一致性強。
- 新型的自動抬壓腳和剪線機構·速度更快更穩定。
- 乾式無油機頭·無需擔心污染縫料·更環保。
- 全密封內潤滑機構·整機噪音更低·使用壽命持久。
- Focus on quality, efficiency and performance.
- Control box and machine head connect together; easy for installation.
- Brand new control panel, easy to use.
- New design for auto presser foot lifter and for automatic thread trimmer; with faster and more stable performance.
- Machine head with oil-free structure; no oil stains; environment-friendly.
- Sealed structure of lubrication; low noise; longer service life.



特點

FEATURES

1 閉環控制系統：

步進馬達閉環智慧運動控制系統·能夠即時監控機械結構的運動趨勢·對運動偏差進行即時補償和修正·減少高速運行時的失步·消除了機械配合誤差·提高動作精準度·達到提升效率的目的。

Closed control system：

stepping motor closed control system can do immediate monitor of the mechanic movement, both make up and correct the deviations, cut the reaction time, rise the efficiency and accuracy, ensure the productivity.

2 高效地生產性能：

實現了高速的縫製速度 3,300 S.P.M.·通過高速的性能·能快速啟動和終止縫製·通過高速的切線速度以及自動抬壓腳操作·大幅度縮短了套結循環時間。

Higher productivity：

The machine realizes high speed 3,300 S.P.M., in addition to the high speed sewing performance, cycle time can be substantially decreased.

3 優質的縫製品質：

配備面線夾線機構·它可防止起縫時的鬆線·以及布料反面的鳥巢現象·還消除了面線被污染的情況·通過進一步改進切線機構·使切線後留在布料反面的線殘量變短。

Excellent seam quality：

With needle thread nipper, which prevents thread slipping off from the needle hole at the beginning of sewing, and bird-nest problem on the bottom side, and also oil stain problem. For the advanced thread trimming mechanism, the remained thread-end can be shortened.

閉環和開環對比 Comparison of Open & Closed system		
項目 Item	回饋系統 Feedback	對運動偏差即時補償 Reaction of deviation compensation
開環系統 Open	無 No	無 No
閉環系統 Closed	有 Yes	有 Yes

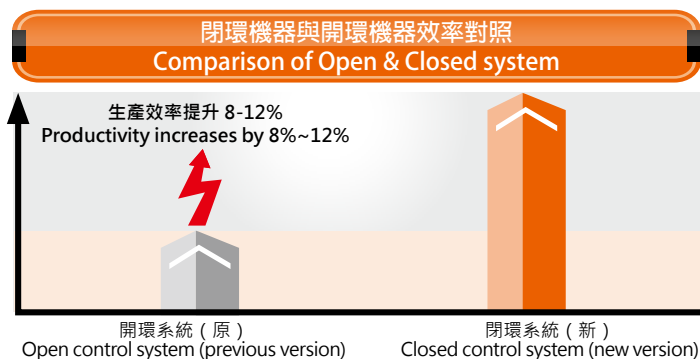

規格
SPECIFICATION

型號 Model	用途 Application	mm 	Needle No.	布料厚度 Fabric Weight					mm 	 S.P.M. (Max)	縫製區域 (X×Ymm) Sewing area (X×Ymm)
				L	M	H	手動 Hand	自動 Auto			
LKS-I900D-SS	套結 Bartacking	41.2	DP ×5 #11				標準 14，最大 17 (反轉抬針時) Standard: 14 Maximum: 17 (moment of reversing and lifting)	0.1~10.0 (0.1 單位)	3300	40x30	
LKS-I900D-HS			DP×5 #14								
LKS-I903D-SS	釘扣 Button sewing		DP×17 #19							2800	6.8x6.8

用途 Function	套結 Bartacking	釘扣 Button sewing
送布 Fabric Feeding	間接送布 (步進馬達 2 軸驅動方式) Indirect fabric feeding (Driven by 2-axis stepping motor)	
抬壓腳方式 Way of presser foot lift	步進馬達 Stepping motor	
旋梭 Hook	半旋轉標準旋梭或半旋轉倍旋梭 Standard hook with semi-rotation or other hook with semi-rotation	
加油方式 Way of adding oil	旋轉部：微量加油 Rotation part: add oil with minimum capacity	
放大縮小功能 Function of Zoom in & Zoom Out	X 方向、Y 方向各自獨立縮放 20%~200% (1% 單位) Zoom in and Zoom out 20%~200% independently of X axis and Y axis	
放大縮小方式 Way of Zoom in & Zoom out	線跡長度增減方式 Stitching length adjustment	
標準縫紉圖案 Standard Sewing Pattern	100 種圖案 100 Patterns	50 種圖案 50 Patterns
USB 存儲圖案數 Max. Number Of Stored Memory Patterns For USB	100 組 100 Combos	
儲存容量 Capacity	最大 20000 針 Maximum with 20,000 needles	
馬達 Motor	直驅式 AC 伺服馬達 550W Direct-drive AC Servo Motor 550W	
電源 Power supply	AC 220V ± 10%; 50/60Hz	
額定功率 Power	600W	
重量 Weight	機頭 (包括馬達) : 45 kg, 電子控制箱 : 5 kg Machine Head (including motor): 45 kg, Electronic Control Box: 5 kg	

※ 最高縫製速度請根據縫製條件降低速度使用。 ※Max speed varies base on actual sewing condition.

4 Needle 6 Thread Feed-off-the-arm Flatseamer

D007SP - 4 52 - 02 R - T1 / AW1

①機種別 Model

D007SP
S款一般型
General Type

D007SXP
S款雙差動型
Dual-differential Type

D007RB
R款一般型
General Type

②針數 Needle Numbers

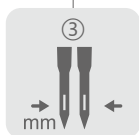

④切刀 Trimmer

01

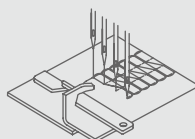

02

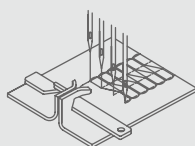

⑤特殊規格 Special Specification

R 弧狀車縫
Curved Seaming

H 厚類車縫 (過目、過骨車縫)
Heavy-Weight Material Seaming
(Cross Seaming of Binding / Taping
or Overlock Seam)

AC 布邊防捲曲
Anti-Curl Edge

⑦選配件 Attachment

⑥車縫功能 Seaming Function

S 褲襠
For Panty Hose

DS 潛水衣
For Diving Suit

T1 織帶(女用內衣褲)
For Attaching Woven Tape
(Women's Underwear)

T2 貼條(男用內衣褲)
For Attaching Folded Tape
(Men's Underwear)

4L10 段差型壓腳針板組
Step Type Presser Foot and
Needle Plate

4L15
4L20



I 1.0, 1.5, 2.0 mm

D007 | Series

四針六線曲臂式併縫機

4 Needle 6 Thread Feed-off-the-arm Flatseamer

D007SP SERIES FEATURES



D007SP

四針六線曲臂式併縫機

4 Needle 6 Thread Feed-off-the-arm Flatseamer

D007SP為全新的進階款，專為貼身衣物與機能型運動衣的疊併縫所設計，提供即強韌又柔和的車縫效果

All new D007SP realizes the strong and delicate sewing quality for intimate fit wear and high-end sportswear's flat-seaming.

特 点 FEATURE

線道採精密陶瓷設計，使過線收線更加順暢，線跡更均勻穩定，有效提升車縫效果

The ceramic precision design of the line that makes the winding line is smooth. Stitches are better stable and average, and the sewing effect is effectively improved.

驅動馬達與機體結合採一體成形設計，避免組裝誤差，有效降低車體震動

The driving motor is combined with the sewing machine to form a single machine. Design to avoid assembly errors and effectively reduce sewing machine vibration.

針座部位改採全包覆一體式設計，杜絕漏油的可能性。

The needle seat is changed to a fully covered and integrated design to prevent the possibility of oil leakage.



D007SXP

四針六線曲臂式併縫機附雙差動

4 Needle 6 Thread Feed-off-the-arm Flatseamer interlock sewing machine with dual differential feed



特 点 FEATURE



延續D007SP之特點，外加外撥式針距調整撥桿設計，可輕易調整各式差動量，滿足各種布類所需之車縫品質。

D007SP features with the new design stitch-length adjustment lever for easy adjustment on the differential range, ensuring consistent stitch quality on different types of fabrics.



選購件 OPTIONAL ATTACHMENT

AW1 外接空壓式吸布屑組 *需外接空壓機
External compressor type waste suction set
*for compressor compatible

AK 電眼氣動切線組
Sensor controlled pneumatic type chain cutter

AW2 吸風馬達式吸布屑組
Suction motor type waste suction set

LFA 電動式直向送帶裝置(搭配T1)
Electric Type Upper Tape Feeding Device (for T1)

AW7 外接式吸布屑組 *需外接空壓機(搭配AK)
The external waste suction set
*for compressor compatible (for AK)

LF290 抖帶輪(搭配LFA)
Untangle Wheel (for LFA)



AW1



AW2



AK



LFA



LF290









規格

SPECIFICATIONS

D007SP - 4 52 - 02 R - T2 / AK

規格索引，詳細請參考P.174 Specification index, please refer to P.174

- ① 機種別 Mode
- ② 針數 Needle Numbers
- ③ 針距 Needle gauge
- ④ 切刀 Trimmer
- ⑤ 特殊規格 Special Specification
- ⑥ 車縫功能 Seaming Function
- ⑦ 選配件 Attachment

DS01	 x		 ③					
D007SP/SXP-4 ③-01	4	6	4.8/5.2/6.0	1.6 2.5	1:0.7 1:1.5	8	FL X 118GCS (4 PCS) FLG - 1 (1 PC)	4200
D007SP/SXP-4 ③-02	4	6	4.8/5.2/6.0			6		
D007SP/SXP-4 ③-02R	4	6	4.8/5.2/6.0			6		
D007SP/SXP-4 ③-02H	4	6	5.2/6.0			6		
D007SP/SXP-4 ③-01-S	4	6	5.2/6.0			8		
D007SP/SXP-4 ③-02-S	4	6	5.2/6.0			6		
D007SP/SXP-4 ③-02-T1	4	6	4.8/5.2/6.0			6		
D007SP/SXP-4 ③-01-T2	4	6	5.2/6.0			8		
D007SP/SXP-4 ③-02-T2	4	6	5.2/6.0			6		

Remarks :

FLG - 1 為假針規格，避免車縫薄軟面料之縫份起皺。

FLG - 1 is a retainer for seaming light / soft materials without seam wrinkling.

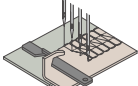
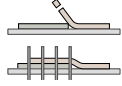
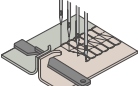
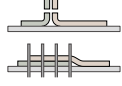
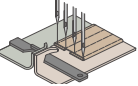
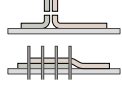
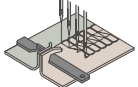
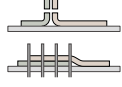
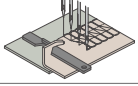
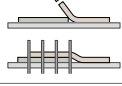
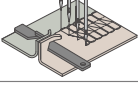
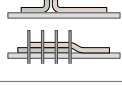
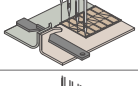
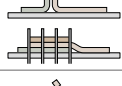
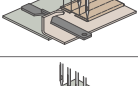
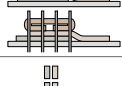
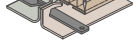
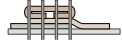
Model	Trimming	Cross-section	Fabric Weight		
			Light	Medium	Heavy
D007SP/SXP-4 ③-01					
D007SP/SXP-4 ③-02					
D007SP/SXP-4 ③-02R					
D007SP/SXP-4 ③-02H					
D007SP/SXP-4 ③-01-S					
D007SP/SXP-4 ③-02-S					
D007SP/SXP-4 ③-02-T1					
D007SP/SXP-4 ③-01-T2					
D007SP/SXP-4 ③-02-T2					

D007RB SERIES FEATURES



新型後切刀

以電磁閥驅動，橫向連杆增加彈簧設計，調整更方便

New chain cutter

Solenoid type cutter with new design mechanism, which make the connecting rod adjustable easily by the spring.



新型潤滑設計

壓腳棒封閉機構設計，並有強制供油回油，前蓋密封且採用倒回流設計，確保零漏油

New Lubrication Design

Sealed type presser foot mechanism with active oil supply and return, and the front cover is sealed without opening realize zero oil leakage.



雙護針機構

專利雙護針設計 (類似三針車的行程)，更穩定控制高速車縫線跡，且較不易斷線

Dual-Needle Guard Mechanism

Patented dual-needle guards (similar to interlock's stroke) make high speed sewing stable and reduce the problem of needle or thread breaking.



高速車縫的穩定度再提升

新型直驅傳動設計，主軸結合馬達轉子，直接傳動不需連軸器配合零件精度的提升，高速車縫更穩定

High Speed Sewing's Stability is Upgraded

New direct-drive design, which the rotor is fixed in the main shaft without connector, is more directly for power delivery. Moreover, spare parts accuracy is upgraded to make a more stable high speed sewing.



全系列併縫上下布邊皆可四針包到位

特殊機構設計，適用不同面料，可達到上下布邊皆可四針包到位之縫製需求

Fully Coverstitching For All Lapseamer Series

Unique mechanism design to deal with wide range fabrics fulfills the sewing request for top and bottom plies lapseaming, going fully to both left and right edge of the stitch.



全新專利隱藏式抬壓具機構

巧妙將抬壓腳電磁閥考量配重藏入機座，節省風力及氣動配件；整機輕量化，避震安靜，外型簡潔；省時省力，提高產能

Patented Electric Presser Foot Lifter Mechanism

The Solenoid smartly concealed in holding base, saving pneumatic volume and accessories, for less weight, anti-vibration, low noise, well balanced body and tidy looks, resulting in time-saving, labor-saving, and higher productivity.





特殊切布刀設計

採用特殊材質·經鏡面處理·低磨擦係數·鋒利耐用·提高縫製品質

Special Fabric Trimmer Design

Unique fabric trimmer with special material and mirror finish, resulting in frictionless, sharp & durable trimming to enhance sewing quality.



超細筒機構設計

過針部之懸臂周長僅150mm·小筒型之衣物縫製也能得心應手·如童裝之袖子

Minimum Cylinder Design

150mm circumference at the needles allows for sewing small tubular work, such as the sleeves seaming of children's wear.



控線更優異

密封式控線鈕；防止繞線；提高縫製之順暢與穩定·過線件全部為陶瓷材質·超耐磨·更滑順

Better Threading Control

Sealed thread tension control knob design, preventing from exceptional winding, makes sewing more smooth and stable. Threading parts are all with ceramic material, which is super wear-resistant, super smooth.



送具機構防油

送具機構新增刮油窗設計·下座的防油性能好

Feed Dog Mechanism Oil Proof

Feed Dog Mechanism is equipped with oil wiper to upgrade sewing bed portion's oil proof level.



標配LED燈·具有5段亮度調節

Standard equipped LED lights with 5-level brightness adjustment.

選購件 OPTIONAL ATTACHMENT



AW1 外接空壓式吸布屑組

*需外接空壓機

External compressor type waste suction set

*for compressor compatible



LFA 電動式直向送帶裝置(搭配T1)

Electric Type Upper Tape Feeding Device (for T1)



AK9 電眼電動切線組+外接式吸布屑組

*需外接空壓機

Sensor electronic type thread cutter & The external waste suction set

*for compressor compatible



LF290 抖帶輪(搭配LFA)

Untangle Wheel (for LFA)



EW2 密封式吸布屑組









*內含吸風馬達

The sealed waste suction set

*equipped with suction motor











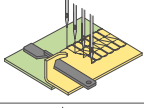
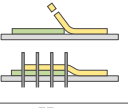

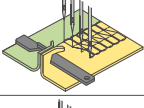
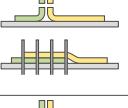

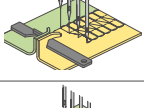
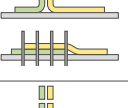

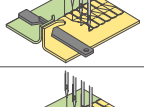
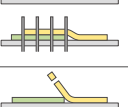

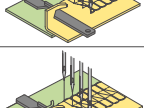
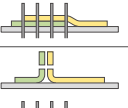

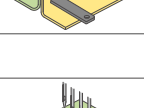
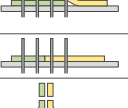

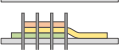
規格/ SPECIFICATION

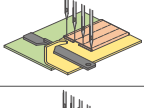
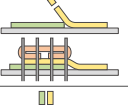
RB01	 x		 mm + ③	 mm		 mm	 Needle No.	 S.P.M. (Max)	OPTIONAL	
D007RB-4③-01 *	4	6	4.8/ 5.2/ 6.0/ 6.4	1.6	1: 0.7 1: 1.5	8	FL X 118GCS (4 PCS)	4200	AW1/ EW2/ AK9	
D007RB-4③-02 *	4	6	4.8/ 5.2/ 6.0/ 6.4						6	AW1/ EW2/ AK9
D007RB-4③-02R *	4	6	4.8/ 5.2/ 6.0/ 6.4						6	AW1/ EW2/ AK9
D007RB-4③-02H	4	6	5.2/ 6.0						6	AW1/ EW2/ AK9
D007RB-4③-01-S	4	6	5.2/ 6.0						8	AW1/ EW2/ AK9
D007RB-4③-02-S	4	6	5.2/ 6.0						6	AW1/ EW2/ AK9
D007RB-4③-01-DS	4	6	5.2/ 6.0	2.5		8		AW1/ EW2/ AK9		
D007RB-4③-02-T1	4	6	4.8/ 5.2/ 6.0					6	AW1/ EW2/ LFA/ AK9	
D007RB-4③-01-T2	4	6	5.2/ 6.0					8	AW1/ EW2/ AK9	
D007RB-4③-02-T2	4	6	5.2/ 6.0					6	AW1/ EW2/ AK9	

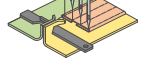
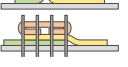
Remarks :

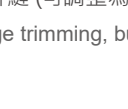
- 標示 * 的型號也供應552機型(5針7線5.2針距)。
 - 552機型具特殊針規·主適用於Spandex面料之縫製·採購此款機針時請徑洽SiRUBA代理商以符合原廠規格。
 - FLG - 2為假針規格·避免車縫薄軟面料之縫份起皺。
- The model with * mark is available for 552 model (5 needle 7 thread 5.2 needle gauge).
 - 552 model with special needle shank spec is mainly designed for Spandex fabrics. While purchasing the needles of 552, please directly contact Siruba to meet original spec.
 - FLG - 2 is a retainer for seaming light / soft materials without seam wrinkling.

Model	Trimming	Cross-section	Fabric Weight		
			Light	Medium	Heavy
D007RB-4 ③-01					
D007RB-4 ③-02					
D007RB-4 ③-02R					
D007RB-4 ③-02H					
D007RB-4 ③-01-S					
D007RB-4 ③-02-S					
D007RB-4 ③-01-DS *					
D007RB-4 ③-02-T1					
D007RB-4 ③-01-T2					
D007RB-4 ③-02-T2					

「*」 DS model : 潛水衣規格·出廠標準為無切布之接併縫(可調整為單切疊併縫)

「*」 DS model : Diving suit sewing's standard is non-edge trimming, butt seam (One side edge trimming lap seam is adjustable.)

LZ SERIES FEATURES



LZ457A

143N

L

機種別 Model

曲折縫縫紉機
High Speed One Needle Zig-Zag Stitching Machine

表示功能或用途
Function or Purpose

143N 萬能車
Universal Sewing

車縫布料
Sewing Material

L 薄布料
Light
M 中厚布料
Medium

LZ1388

0

/

L

機種別 Model

曲折縫縫紉機
High Speed One Needle Zig-Zag Stitching Machine

表示功能或用途
Function or Purpose

0	2點人字車縫-最大擺寬5mm Two points zig zag stitching-max width is 5mm
1	2點人字車縫-最大擺寬8mm Two points zig zag stitching-max width is 8mm
3	3點人字車縫-最大擺寬8mm Three points zig zag stitching-max width is 8mm
6	4點人字車縫-最大擺寬8mm Four points zig zag stitching-max width is 8mm
5/140	漁網狀3針4點車縫-最大擺寬8mm Fishnet type three stitches four points zig zag stitching-max width is 8mm

車縫布料
Sewing Material

L 薄布料
Light
M 中厚布料
Medium

漁網車 Fishnet Type



Fishnet

LZ1388-5/140L

漁網狀3針4點人字形，適用於束褲、束腹、塑身衣褲、護腰、醫療及運動器材...

Fishnet type three stitches four points zigzag sewing type. Suitable for corsets, fitting clothes, waist protection clothes, medical and fitness equipment, etc.

萬用車 Universal Type









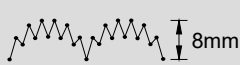
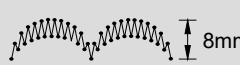

專利萬用可換花盤
Patented Universal
Decorative Cam

LZ457A-143N-L

可作裝飾縫製，新式流行女用緊身內衣褲及襯衫之縫紉。配合線跡需要而備有多種花樣凸輪供更換

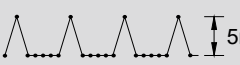
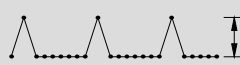
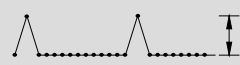
Decorative sewing, new type fashion feminine underwear and shirts. Multiple decorative type cam for changing based on needs.

花盤(凸輪)選購表(Optional Cams)

12針跡開式扇形花盤 NP-6358 12-stitch opened scallop cam	24針跡新月扇形花盤 NP-6360 24-stitch crescent scallop cam	24針跡勻稱扇形花盤 NP-6464 24-stitch even scallop cam	24針跡勻稱扇形花盤 NP-6295 24-stitch even scallop cam
			
4針跡盲縫花盤 NP-6396 Blind stitch cam (4 stitches)	6針跡盲縫花盤 NP-6364 Blind stitch cam (6 stitches)	8針跡盲縫花盤 NP-6480 Blind stitch cam (8 stitches)	12針跡盲縫花盤 NP-6482 Blind stitch cam (12 stitches)
			
普通Z字形花盤 NP-6394 1-step Zig Zag cam	2針3點Z字形花盤 NP-6462 2-step Zig Zag cam	3針4點Z字形花盤 NP-6362 3-step Zig Zag cam	
			

規格/ SPECIFICATION

				用途 Applications	圖形 Graph
LZ1388-0	Max 5.0mm (13/64")	2.0mm (13spi)	5000	可做蕾絲花邊及肩帶縫製等等 Attaching lace, making shoulder straps etc.	
LZ1388-1	Max 8.0mm (5/16")	1.3mm (20spi)	5000	可做蕾絲鑲邊及一般人字形之縫紉 Attaching lace and making general herringbone sewing.	
LZ1388-5/140L	Max 8.0mm	6.5mm	4000	漁網狀3針4點人字形。 Fishnet type three stitches four points zigzag sewing type.	
LZ1388-5/140M	Max 8.0mm	6.5mm	4000		
LZ1388-3	Max 8.0mm (5/16")	1.3mm (20spi)	5000	可做緊身衣物或胸衣之鬆緊帶縫製 Elastic seaming and attaching for corsets or bras.	
LZ1388-6					
LZ457A-143N-L (Universal Type)	Max 8.0mm (5/16")	1.3mm	3400	裝飾縫製配合線跡需要而備有多種花樣凸輪供更換 (5.0mm凸輪隨車附於配件盒裡) Decorative sewing, multiple decorative type cam for changing based on needs. (The 5.0mm cam is attached inside the accessory box with each product.)	
	Max 5.0mm (13/64")	2.0mm			

MDL312 / MDL314



機械式鬆緊帶調節裝置

MDL312:送帶寬度2" (50mm)

MDL314:送帶寬度4" (100mm)

Mechanical metering device for elastic tape

Feeding width: 2"(50mm)

Feeding width: 4"(100mm)

DL3880 SERIES

CHAINSTITCH SEWING MACHINE



DL 388 3 R H - 64 P

機種別
Model

DL 直驅型
Direct-drive type

針數
Number of needles

1	單針 Single Needle
2	雙針 Two Needles
3	三針 Three Needles

針向
Needle array

- (雙針)橫列
(Two Needles)Parallel
- R (雙針)縱列
(Two Needles)Tandem
- (三針)斜三針*
(Three Needles)Oblique
- R (三針)三角針*
(Three Needles)Triangular

*註 Remark :

車縫布料
Sewing fabric

- 中厚料
Medium
- H 厚料
Heavy

No.	mm	inch
32	3.2	1/8"
48	4.8	3/16"
64	6.4	1/4"
95	9.5	3/8"

後拖輪
Rear puller

- 無
None
- P 平膠拖輪
Rubber wheel
- G 齒型膠輪
Plastic gear
- I 齒型鐵輪
Iron gear
- AP 氣動拖輪
Pneumatic Puller

產品特點 :

- 一、彎針機構採用的是傾斜彎曲體型的裝置，能發揮優越的耐久性。
- 二、加固縫是與平縫機相同都可通過反縫拉桿進行操作，可確實的防止脫線。
- 三、可對縫跡長度進行簡單的調節。
- 四、帶拖輪裝置，拉料更順暢，縫跡更加平整。

Features

- The looper mechanism adopts an obliquely curved body type device, which exhibits excellent durability.
- The bartack function is the same as the lockstitch machine, which can be operated by the reverse stitching lever, which can definitely prevent thread release.
- The stitch length can be easily adjusted.
- The puller device makes the cloth feeding smoother and the stitch forms more flat.

規 格 SPECIFICATIONS

DL3880		Needle NO.		mm			選配 Option	
							後拉輪 Rear Puller	桌板 Table
DL3881	-	TVx7 #14~#21	2	Min: 1.4 mm Max: 4 mm	8~10mm	3500	-P -G -I -AP	DL7000T-T1
DL3882(H)	3.2 / 4.8 / 6.4 / 9.5	or	4					
DL3882R	-	UY128GAS	6					
DL3883(H)	6.4	#14~#20						
DL3883R(H)	6.4							

AA FEATURES



手提式縫袋口機(附加潤滑油裝置)





手提操作，輕便快捷，每台約 5 公斤。自動切線及壓具提升裝置，塑膠握把附皮帶護蓋，可加裝掛勾裝置，節省人力，機構優良附加潤滑油裝置，經久耐用。適宜縫合各類紙袋、麵粉袋、塑膠編織袋、麻袋及其他袋類之袋口縫合或布頭接合染整



portable bag closer(with lubricating device)

Light weight, easy operation with automatic thread cutter and presser foot lifter. Equipped with lubricating device for oiling and prolonging machine life . For closing all kinds of paper, cotton, PP/PE and gunny bags for packing feeds, seed, fertilizer, flour, chemical powder etc. Also available for closing textile end-join before dyeing.

規格/ SPECIFICATION

A1	 x		 mm	 Needle No.	 S.P.M. (Max)
AA-6	1	1	7.2	D5	1700



台灣

TAIWAIN



高林股份有限公司

總公司

105台北市民生東路三段128號11樓
電話：+886-2-27130232
傳真：+886-2-27130318 / +886-2-27130501

台北門市部

台北市士林區社子街38號
電話：+886-2-28168808
傳真：+886-2-28168806



桃園廠

桃園市桃園區國際路一段246號
電話：+886-3-3262128 ~31
傳真：+886-3-3262127

KAULIN MFG. CO., LTD.

HEAD OFFICE

11F., No.128, Sec. 3, Minsheng E. Rd., Songshan District, Taipei City, Taiwan.
TEL : +886-2-27130232
FAX : +886-2-27130318 / +886-2-27130501

RETAIL DEPT.

No.38, Shezi St., Shilin Dist., Taipei City 111, Taiwan.
TEL : +886-2-28168808
FAX : +886-2-28168806

TAOYUAN FACTORY

No.246, Sec. 1, Guoji Rd., Taoyuan Dist., Taoyuan City, Taiwan.
TEL : +886-3-3262128 ~31
FAX : +886-3-3262127

中國

CHINA



寧波高林銀箭機電有限公司

浙江省寧波市北侖區龍潭山路16號(郵編：315806)
電話：+86-574-55016666
傳真：+86-574-86114666 / 86117799

KAULIN M.&E. INDUSTRIAL CO.,LTD.

No. 16 Long Tan Shan Road Bei Lun District, Ningbo City Zhejiang Province China.
TEL : +86-574-55016666
FAX : +86-574-86114666 / 86117799

美國

AMERICA



SIRUBA 美國分公司

11380 NW 36th TERRACE, DORAL, FL 33178, U.S.A
電話：(1)305-477-4562
傳真：(1)305-477-7524

SIRUBA LATIN AMERICA INC.

11380 NW 36th TERRACE, DORAL, FL 33178, U.S.A
TEL : (1)305-477-4562
FAX : (1)305-477-7524

越南

VIETNAM



SIRUBA 越南子公司

Lô số 3, Khu biệt thự Hoa Phượng, xã An Khánh, huyện Hoài Đức, Hà Nội
電話：+84-024-73079888

SIRUBA MACHINERY VIETNAM CO., LTD.

Lô số 3, Khu biệt thự Hoa Phượng, xã An Khánh, huyện Hoài Đức, Hà Nội
TEL : +84-024-73079888



SIRUBA 越南胡志明市辦事處

549 Hoang Van Thu, Phuong 4, Tan Binh, TP. Ho Chi Minh

Siruba Machinery Vietnam CO., (HCMC Branch)

549 Hoang Van Thu, Phuong 4, Tan Binh, TP. Ho Chi Minh

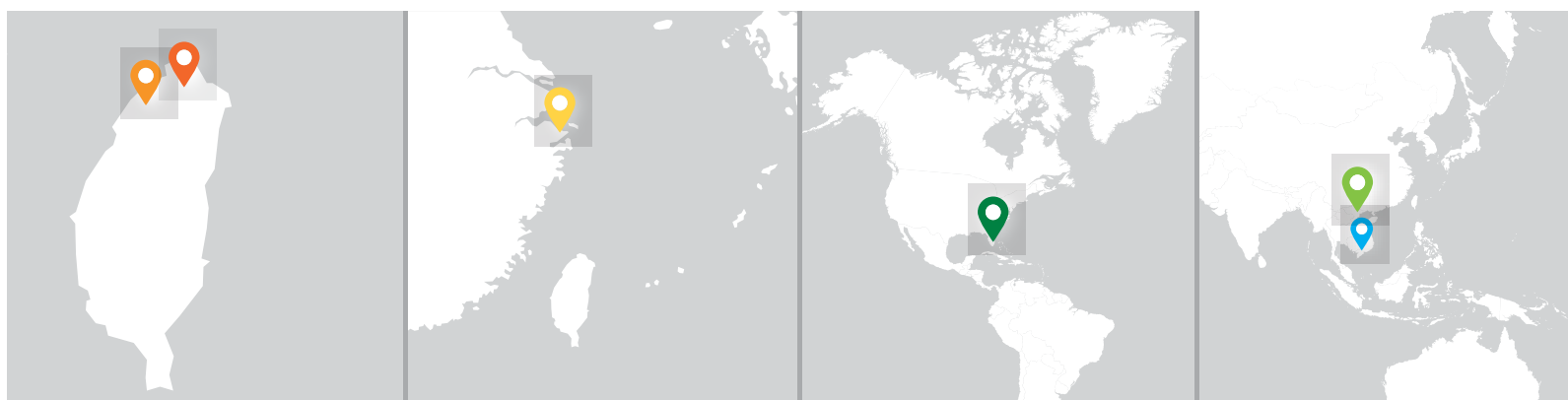



 高林股份有限公司
KAULIN MFG. CO., LTD.

 TOP 100
TAIWAN BRANDS



ISO 9001:2000
ISO 14001:2004

由於對產品的改良及更新，本產品型錄中之產品規格及外觀的修改恕不事先通知
The specification and/or appearances of the equipment described in this catalogue are
subject to change without previous notice because of modification.

C.S2022-01 JULY 2022

