



NOBLELIFT

Material Handling

EDGE



PSE26N SL Straddle Stacker

Li-ion Powered 2600lbs/1200kg , Lift height: up to 142inch/3.6m.

NOBLELIFT INTELLIGENT EQUIPMENT CO., LTD

www.noblelift.com

PSE26N SL

The EDGE Smart Design Pallet Stackers

PSE26N SL

- 2600lbs/1200kg Capacity **Li-ion**
- Perfect for light-duty applications
- Compact & light service weight
- High maneuverability
- Fast-charging Li-ion batteries
- Integrated on-board 25A charger
- Ideal for use on mezzanines
- Ultimate solution for light duty operations

DC 24V



Smart and Ergonomic Tillers

Standard For PSE26N SL

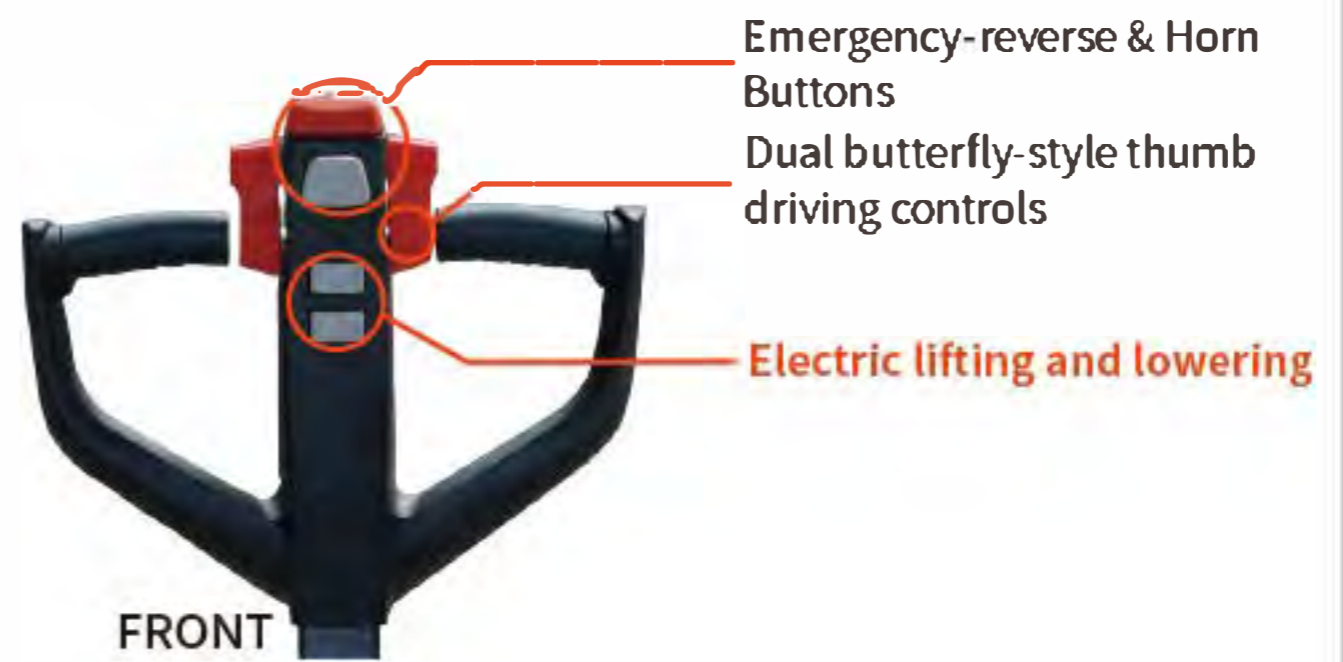
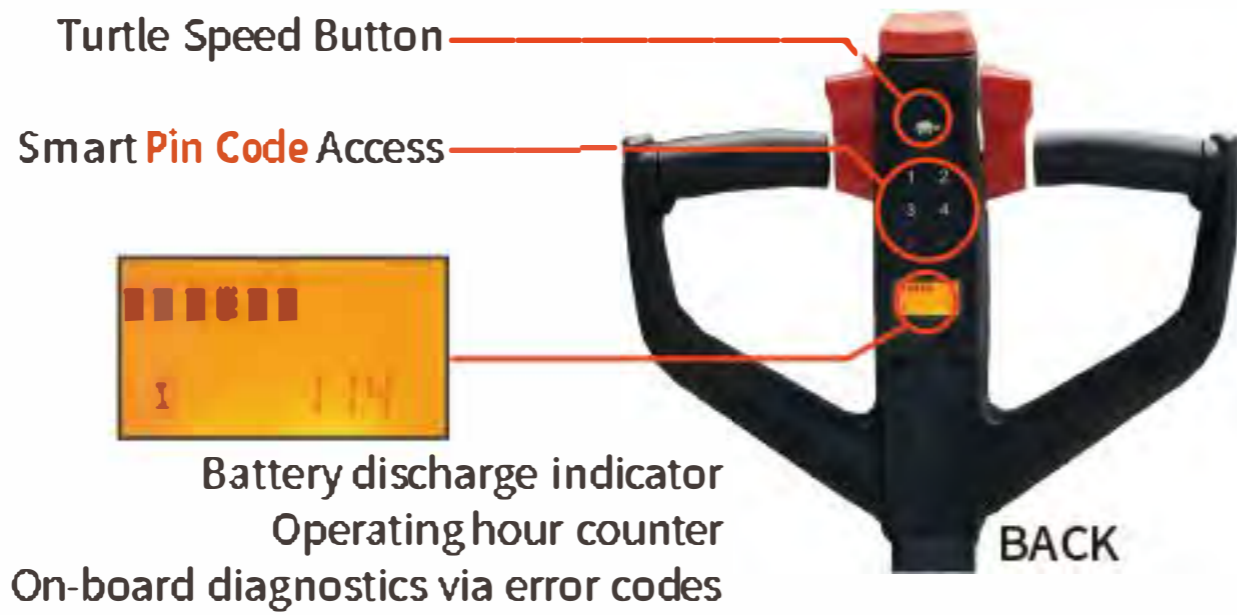

RFID Card Access is standard for PSE26N SL

RFID card provides faster access to equipment and is ideal for applications when one truck needs to be used by different operators



Vertical Driving in Confined Space



The ability to operate the unit with the tiller in the upright position allows working in confined spaces.

The tiller bar is supported by the air spring which helps to return the tiller to its vertical position without impact.

For increase of operation comfort and safety the trucks are equipped with speed reduction in turns.



Great stability and safety with its 3-point structure design

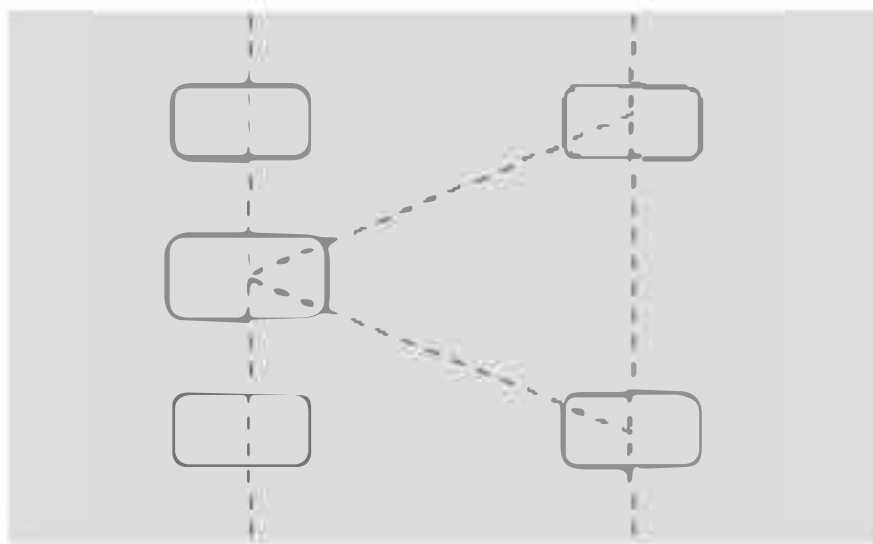

Chassis with 3+2-point structure: 1x+2/2

- The drive wheel is located in the middle for better traction and stability of the stacker.
- The support wheels with suspension are located from left and right sides and provide better lateral stability to the truck.
- Straddle legs are equipped with single rollers.

Maintenance Friendly

Convenient and fast access to any component of the truck, no elements are located in areas difficult to reach. No Special tools are required.

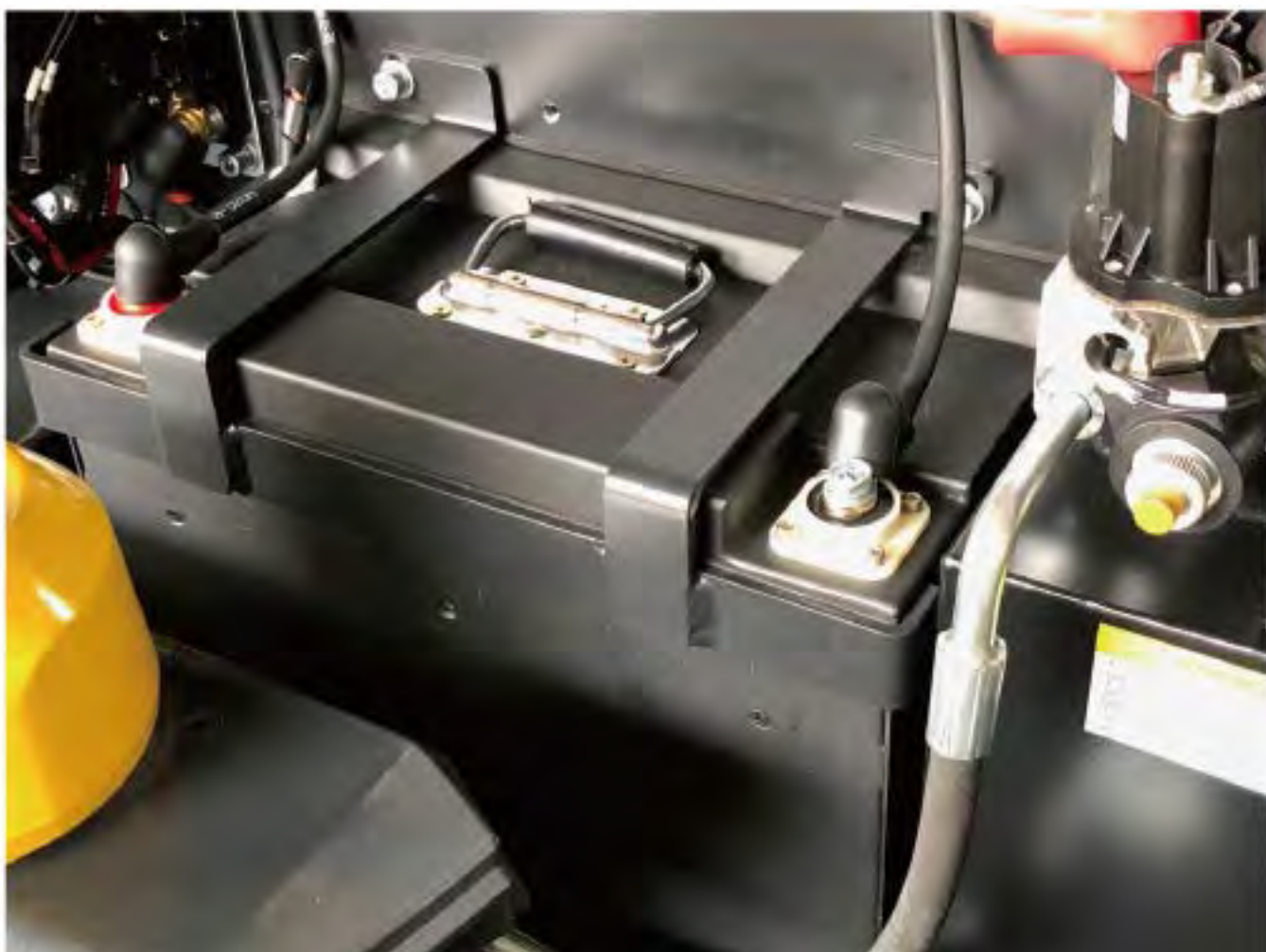

Robustness and Performance



Steel cover

The main cover is made out of steel with thickness 2.0mm



Tiller is made of fiber glass material for high strength.

Capacity of 2600lbs with high residual value at maximum height (load center distance 23.6")

Real mast profiles are used for long life-time, no cheap bended solutions used. All directed to maintain performance of the truck during its life-cycle.



Support legs are made out of solid steel (not tube) to have enough rigidity to ensure the stability and safety.

The width of each leg is consistent which prevents possible hooking of pallets and racks when driving out from the racking system.

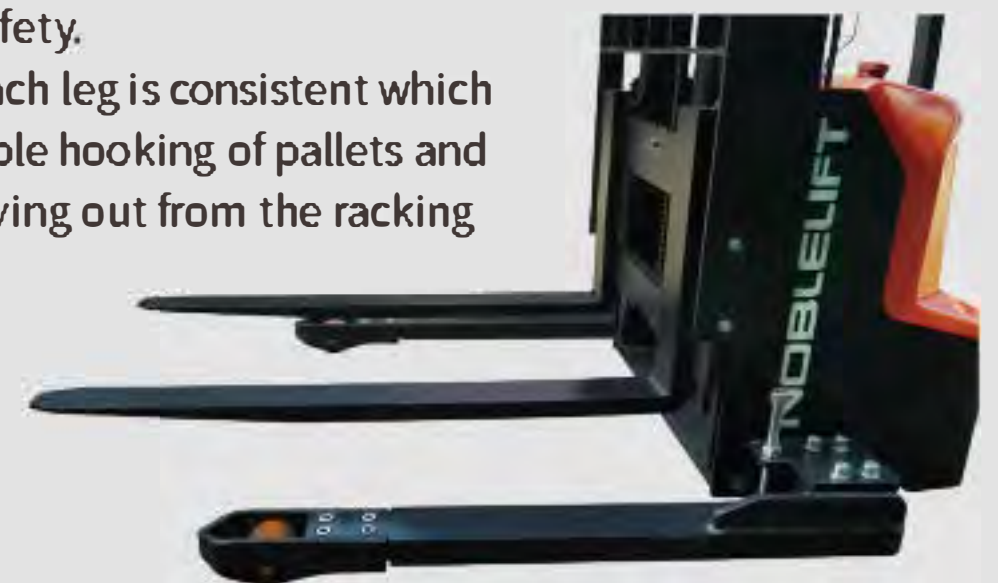

Adjustment of suspension



Perfect Observation



Wide mast provides perfect observation of forks, the field of view is clear and not interrupted by mast sections, cylinder or chains.



The operator can always clearly see the forks which significantly increases safety of operation.

Support legs and forks

The support legs are fixed with screws located outside of the truck's body (4 screws for each side). The position can be easily adjusted according to the customer's needs to achieve the overall width of the truck: 46.5"/50.5"/54.5"/58.3".

Forged forks are supplied for long life. Width of forks is adjustable 9.9-31.5". The truck is equipped with LBR (load back rest) as standard equipment.



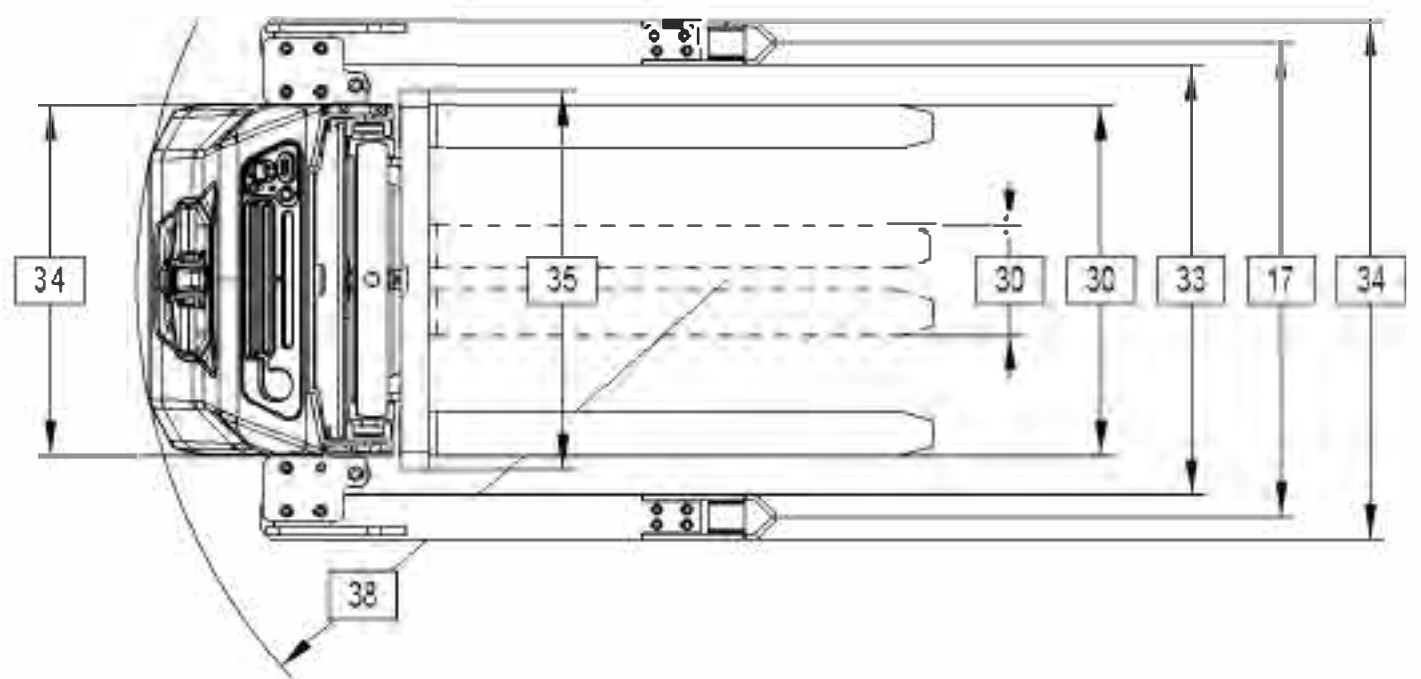
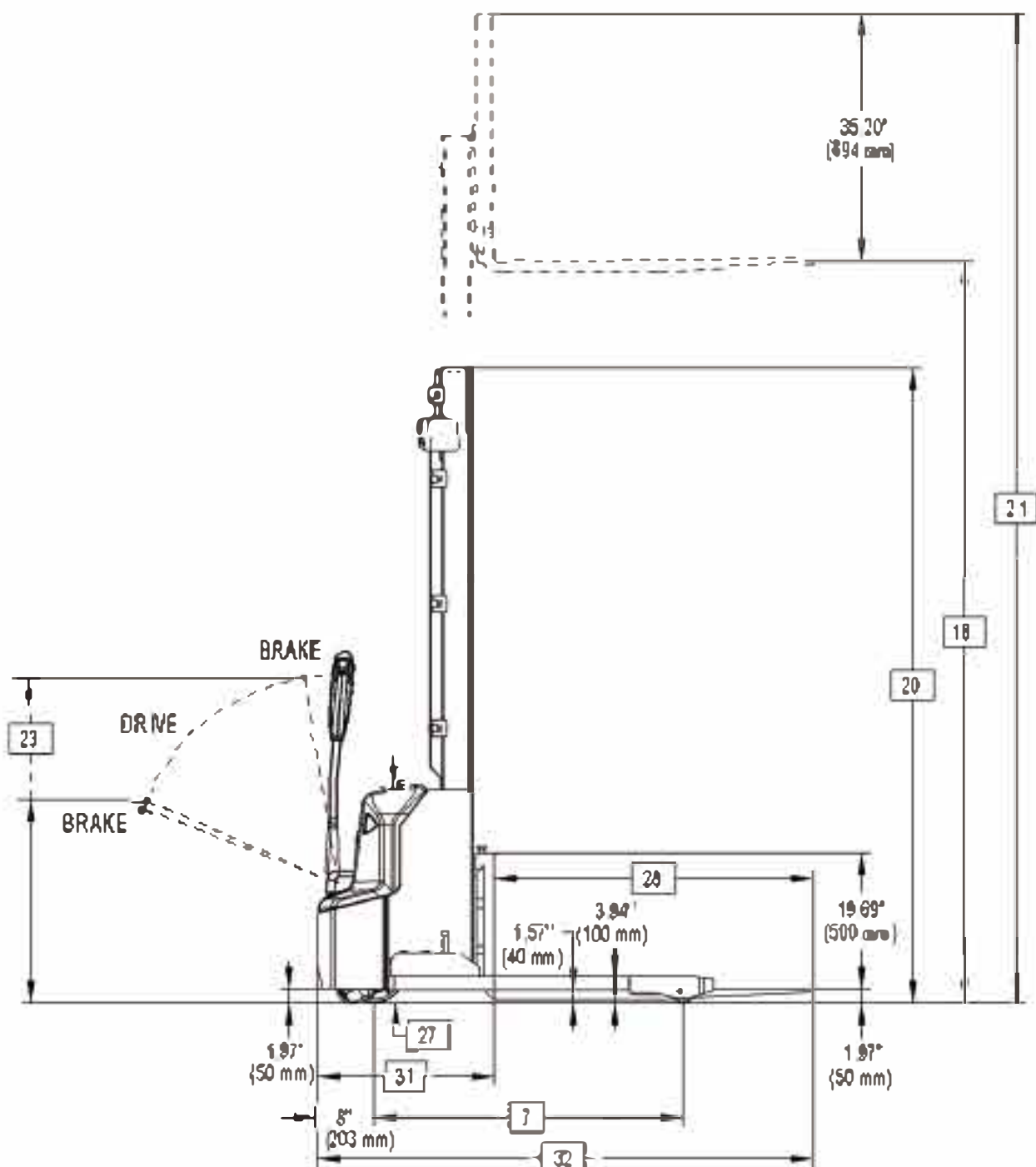

Mast table PSE 26NSL

Lift Height		in	63	79	102	114	126	142
Collapsed Height		in	76.38	92.13	70.47	76.38	82.28	90.16
Extended Height	w/o Load Backrest	in	82.68	98.43	122.05	133.86	145.67	161.42
	w/ Load Backrest	in	98.19	113.94	137.56	149.37	161.18	176.93

Mast table PSE 12NSL

Lift Height		mm	1600	2000	2600	2900	3200	3600
Collapsed Height		mm	1940	2340	1790	1940	2090	2290
Extended Height	w/o Load Backrest	mm	2100	2500	3100	3400	3700	4100
	w/ Load Backrest	mm	2494	2894	3494	3794	4094	4494



PSE26N SL

24V 60Ah Lithium LiFePO4 battery with BMS. Lithium battery has connection terminals with screws and located inside the steel case



For PSE26N SL the charger with current 25A is used
The standard charging time is 2.5 hours
Opportunity charging is supported

The **PSE26N SL** stacker is equipped with maintenance-free 24V/60Ah LiFePO4 type Li-ion battery with fast charging and ultra-high number of charging /discharging cycles during life time; opportunity charging feature basically does not limit your operation time. The integrated BMS provides the same features as the BMS for the batteries of pallet trucks (refer to pallet truck section).

The on-board charger with 25A current can provide full charge for less than 2.5 hours with great efficiency.



Type sheet for industrial truck acc. to VDI2198 (1KG=2.2LB 1INGH=25.4MM)

				Imperial						Metric					
General Information															
2	Model			PSE26NSL						PSE12NSL					
	Mast Type		in mm	63	79	102	114	126	142	1600	2000	2600	2900	3200	3600
3	Power			Electric											
4	Operator Type			Walkie											
5	Load Capacity		lb kg	2600						1200					
6	Load Center		in mm	24						600					
7	Wheelbase		in mm	43.74						1111					
8	Weight Less Battery		lb kg	1421	1466	1587	1609	1631	1675	645	665	720	730	740	760
Tires															
13	Wheel Size Front (d x w)		in mm	8.27 x 2.76						210 x 70					
14	Wheel Size Rear (d x w)		in mm	3.31 x 2.76						84 x 70					
15	Additional Wheels Caster Wheel (d x w)		in mm	3.94 x 1.57						100 x 40					
16	Wheels Number (x = driven)	Front / Rear		1x + 2 / 2											
17	Track Width		in mm	Inside Straddle + 3.94						Inside Straddle + 100					
Dimensions															
18	Lift Height		in mm	63	79	102	114	126	142	1600	2000	2600	2900	3200	3600
20	Collapsed Height		in mm	76.38	92.13	70.47	76.38	82.28	90.16	1940	2340	1790	1940	2090	2290
21	Extended Height	w/o Load Backrest	in mm	82.68	98.43	122.05	133.86	145.67	161.42	2100	2500	3100	3400	3700	4100
		w/ Load Backrest	in mm	98.19	113.94	137.56	149.37	161.18	176.93	2494	2894	3494	3794	4094	4494
23	Tiller Arm Height in Drive Position		in mm	27.95 / 45.28						710 / 1150					
24	Outrigger Height		in mm	3.94						100					
25	Lowered Fork Height		in mm	1.97						50					
27	Power Unit Height		in mm	29.92						760					
28	Fork Lengths		in mm	45.28						1150					
29	Fork Dimensions	Thickness x Width	in mm	1.57 x 3.94						40 x 100					
30	Width Across Forks		in mm	9.92 - 31.50						252 - 800					
31	Headlength		in mm	25.2						640					
32	Overall Length		in mm	Headlength + Fork Length											
33	Inside Straddle		in mm	38.62 / 42.56 / 46.50 / 50.43						981 / 1081 / 1181 / 1281					
34	Overall Width	Front	in mm	31.5						800					
		Rear	in mm	Inside Straddle + 7.87						Inside Straddle + 200					
35	Fork Carriage Width		in mm	33.27						845					
36	Ground Clearance	w/ Load below Mast	in mm	1.57						40					
37		Center Wheelbase	in mm	1.57						40					
38	Turning Radius		in mm	52.95						1345					
39	Length w/ Outriggers		in mm	56.14						1426					
Performance															
40	Travel Speed	w/ wo Load	mph km/h	2.61 / 2.80						4.2 / 4.5					
41	Lift Speed	w/ wo Load	fpm/m/s	21.65 / 31.50						0.11 / 0.16					
42	Lowering Speed	w/ wo Load	fpm/m/s	25.59 / 21.65						0.13 / 0.11					
44	Max Gradeability	w/ wo Load	%	4 / 10											
45	Service Brake			electromagnetic											
Battery															
47	Battery Voltage (Nominal Capacity 5 Hour Rating)	24V Lithium battery (PSE26N SL)	V / Ah	24 / 60											
48	Type of Controller			DC speed Control											
49	Battery Weight	24V Lithium battery (PSE26N SL)	lb kg	42						19					

Note: English conversions are approximations. Metric conversions should be done to find true values.



Official website

Noblelift Headquarters

Add:#528 Changzhou Road, Taihu
Sub-district, Changxing, 313100, China
TEL:+86 572 6210311/6120989
FAX:+86 572 6210777
WEB:www.noblelift.com
Email: info@noblelift.com

Noblelift North America Corp.

Add:2461 S Wolf Road, Des Plaines, IL 60018

Tel:847-595-7100
Fax:847-595-7200
Email:sales@nobleliftna.com
Http: www.nobleliftna.com

Noblelift Europe GmbH

Add:Borsigstrasse 9d-93092 Barbing
Germany
TEL:+49 9401 607930
FAX:+49 9401 6079329
WEB:www.noblelifteuopr.com
Email: mail@noblelifteurope.com

Noblelift Russia

ООО "Ноблелифт Рус"
194292, Санкт-Петербург
Домостроительная ул. 4А офис 301
Бизнес-центр "Парнас"
тел.: +7 (800) 700-28-97
Email: sales@noblelift.com.ru

