

ARO 6.6H-C1-US
ARO 9.9H-C1-US
ARO 13.2H-C1-US
ARO 16.5H-C1-US
ARO 19.8H-C1-US

Installation
&
Operation Manual



Download
Manual



Growatt New Energy

Growatt USA, Inc
9227 Reseda Blvd, #435 Northridge, CA 91324, USA.

T +818 800-9177
E usaservice@ginverter.com
W www.growatt-america.com

GR-UM-225-A-00

Index

1 Information on this document

- 1.1 Validity
- 1.2 Target Group
- 1.3 Storage of the manuals
- 1.4 Symbols in this document

2 Safety

- 2.1 Intended Use
- 2.2 Qualification of skilled person
- 2.3 Safety instruction
- 2.4 Certified countries
- 2.5 DC and AC disconnect
- 2.6 Operation Warnings

3 Product description

- 3.1 ARO-US Overview
- 3.2 Information of Label
- 3.3 ARO-US Dimension and Weight
- 3.4 Transportation

4 Inspection of delivery

- 4.1 Unpacking and inspection

5 Instruction

- 5.1 Safety instruction
- 5.2 Selecting the installation location
- 5.3 Mounting the ARO-US
- 5.4 Opening the wiring compartment

6 Electrical connection

- 6.1 Safety
- 6.2 Intended use
- 6.3 Overview of the connection area
- 6.4 Grounding
- 6.5 connection

7 Commissioning

- 7.1 Checking Before Power-On
- 7.2 Powering on the system
- 7.3 LED description
- 7.4 Powering off the system
- 7.5 Button

8 Decommissioning

- 8.1 Storing the ARO-US
- 8.2 Disposing of the ARO-US

9 Growatt Warranty

10 Technical Data

- 10.1 Specification
- 10.2 Ambient temperature

11 Contact

1 Information on this document

1.1 Validity

This manual describes the assembly, installation, commissioning and maintenance of the following Growatt ARO-US model:

ARO 6.6H-C1-US
 ARO 9.9H-C1-US
 ARO 13.2H-C1-US
 ARO 16.5H-C1-US
 ARO 19.8H-C1-US

This manual does not cover any details concerning equipment connected to the ARO 6.6-19.8H-C1-US (e.g. TL-XH US). Information concerning the connected equipment is available from the manufacturer of the equipment.

1.2 Target Group

This manual is for qualified personnel. Qualified personnel have received training and have demonstrated skills and knowledge in the construction and operation of this device. Qualified Personnel are trained to deal with the dangers and hazards involved in installing electric devices.



1.3 Storage of the manuals



Find further information on special topics in the download area at <http://www.growatt-america.com>. The manual and other documents must be stored in a convenient place and be available at all times. We assume no liability for any damage caused by failure to observe these instructions. For possible changes in this manual, GROWATT NEW ENERGY CO.,LTD accepts no responsibilities to inform the users.

1.4 Symbols in this document









1.4.1 Warnings in this document

A warning describes a hazard to equipment or personnel. It calls attention to a procedure or practice, which, if not correctly performed or adhered to, could result in damage to or destruction of part or all of the Growatt equipment and/or other equipment connected to the Growatt equipment or personal injury.

Symbol	description
 DANGER	DANGER indicates a hazardous situation which, if not avoided, will result in death or serious injury. DANGER indique une situation dangereuse qui, si elle n'est pas évitée, est susceptible de provoquer un décès ou des blessures graves.
 WARNING	WARNING indicates a hazardous situation which, if not avoided, could result in death or serious injury. AVERTISSEMENT indique une situation dangereuse qui, si elle n'est pas évitée, pourrait entraîner la mort ou des blessures graves.

 CAUTION	CAUTION indicates a hazardous situation which, if not avoided, could result in minor or moderate injury. ATTENTION indique une situation dangereuse qui, si elle n'est pas évitée, pourrait entraîner des blessures mineures ou modérées.
 NOTICE	NOTICE is used to address practices not related to personal injury. AVIS est utilisé pour traiter des pratiques non liées aux blessures corporelles.
 Information	Information that you must read and know to ensure optimal operation of the system. Informations que vous devez lire et connaître pour assurer un fonctionnement optimal du système.

1.4.2 Markings on this product

Symbol	Explanation
	Risk of electrical shock Risque electrocution
	Risk of fire or explosion
	Risk of burns injuries Risque de brûlures
	Wait for 5 minutes before engaging in the indicated action Attendez 5 minutes avant de vous engager dans l'action indiquée
	Earth Ground Terre au sol
	Observe the operating instructions Respectez les instructions de service
	Direct Current (DC)
	Alternating Current (AC)
	The ARO-US must not be disposed of with the household waste.

1.5 Glossary

AC

Abbreviation for "Alternating Current"

DC

Abbreviation for "Direct Current"

Energy

Energy is measured in Wh (watt hours), kWh (kilowatt hours) or MWh (megawatt hours). The energy is the power calculated over time. For example, your inverter operates at a constant power of 4600 W for half an hour and then at a constant power of 2300 W for another half an hour, it has fed 3450Wh of energy into the power distribution grid within that hour.

Power

Power is measured in W (watts), kW (kilowatts) or MW (megawatts). Power is an instantaneous value. It displays the power your ARO-US is currently feeding into the power distribution grid.

Power rate

Power rate is the ratio of current power feeding into the power distribution grid and the maximum power of the ARO-US that can feed into the power distribution grid.

Power Factor

Power factor is the ratio of true power or watts to apparent power or volt amps. They are identical only when current and voltage are in phase then the power factor is 1.0. The power in an ac circuit is very seldom equal to the direct product of the volts and amperes. In order to find the power of a single phase ac circuit the product of volts and amperes must be multiplied by the power factor.

PV

Abbreviation for photovoltaic.

Wireless communication

The external wireless communication technology is a radio technology that allows the ARO-US and other communication products to communicate with each other. The external wireless communication does not require line of sight between the devices and it is selective purchasing.

2.1 Intended Use

The Growatt ARO6.6-19.8H-C1-US(Hereinafter referred to as ARO-US) series battery converts the DC current generated by the low-voltage lithium battery module into a high-voltage DC current that meets the requirements of the MIN TL-XH US and performs the work of bidirectional power flow. This series of batteries are manufactured according to all required safety regulations. However, incorrect use may cause fatal hazards to operators or third parties, or may damage equipment and other properties.

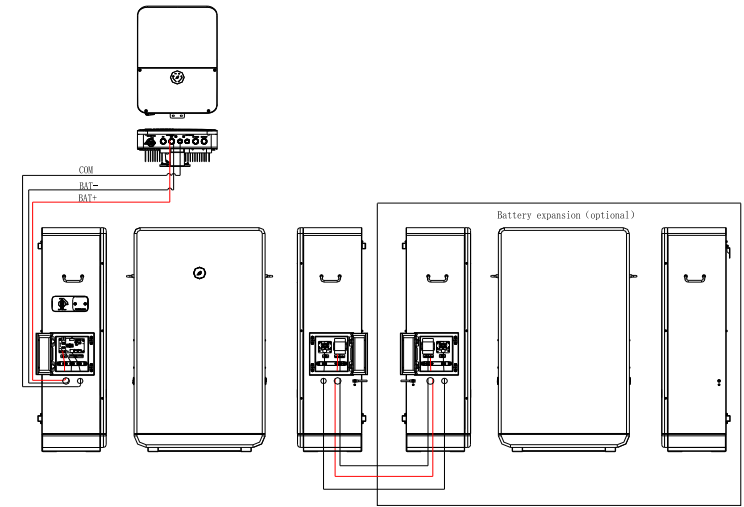

Fig 2.1 ARO 6.6-19.8H-C1-US









NOTE : When connect the ATL battery module to the ARO-US, please make sure that the ATL battery module is turned off, and there is no PV and mains, otherwise there is a risk of electric shock.

2.2 Qualification of skilled person

This grid-connected energy storage system can only operate when it is correctly connected to MIN TL-XH US. This connection must be made only by qualified technical personnel, and it must be carried out after obtaining the appropriate approval under the premise that the local authority having jurisdiction requires it.

2.3 Safety instruction

The ARO-US is designed and tested according to international safety requirements; however, certain safety precautions must be observed when installing and operating this ARO-US. Read and follow all instructions, cautions and warnings in this installation manual. If questions arise, please contact Growatt's technical services at +1 (818)800-9455.

	Danger to life due to lethal voltages! Lethal voltages are present within the unit and on the power supply lines. Therefore, only authorized electricians may install and open the unit. Even when the unit is disconnected, high contact voltages may still be present within the unit.
	Danger of burn injuries due to hot enclosure parts! During operation, the four sides of the enclosure lid and the heat sink may become hot. Only touch the front enclosure lid during operation.
	Electric arc hazards! The product has large electrical potential differences between its conductors. Arc flashes can occur through air when high-voltage current flows. Do not work on the product during operation.
	Risk of fire! Improper installation of the product may cause a fire.
	Possible damage to health as a result of the effects of radiation! In special cases, there may still be interference for the specified application area despite maintaining standardized emission limit values (e.g. when sensitive equipment is located at the setup location or when the setup location is near radio or television receivers). In this case, the operator is obliged to take proper action to rectify the situation. Do not stay closer than 8 inches to the ARO-US for any length of time.
 NOTE	Grounding the PV generator! Comply with the local requirements for grounding the PV modules and the PV generator. Growatt recommends connecting the generator frame and other electrically conductive surfaces in a manner which ensures continuous conduction with ground these in order to have optimal protection of the system and personnel.
 NOTE ARO-US	Permanent connection! The ARO-US may only be operated with a permanent connection to the public power grid. The ARO-US is not intended for mobile use. Any other or additional use is not considered the intended use. The manufacturer/supplier is not liable for damage caused by such unintended use. Damage caused by such unintended use is at the sole risk of the operator.
 NOTE ARO-US	PV modules Capacitive Discharge Currents! PV modules with large capacities relative to earth, such as thin-film PV modules with cells on a metallic substrate, may only be used if their coupling capacity does not exceed 1µF. During feed-in operation, a leakage current flows from the cells to earth, the size of which depends on the manner in which the PV modules are installed (e.g. foil on metal roof) and on the weather (rain, snow). This "normal" leakage current may not exceed 50mA due to the fact that the ARO-US would otherwise automatically disconnect from the electricity grid as a protective measure.

2.4 Certified countries

With the appropriate settings, the unit will comply with the requirements specified in the following standards and directives.

➤ UL1973

Growatt can preset special grid parameters for other countries installation locations according to customer requests after evaluation by Growatt. You can make later modifications yourself by changing software parameters with respective communication products. To change the grid-relevant parameters, an access code is required; please contact Growatt support if needed.

2.5 DC and AC disconnect

Isolate the ARO-US securely from the MIN TL XH-US using DC Switch. DC and AC Switch shall be able to disconnect all ungrounded conductors after installation.

2.5.1 Assembly Warnings

 WARNING	<ul style="list-style-type: none"> ➤ Prior to installation, inspect the unit to ensure absence of any transport or handling damage, which could affect insulation integrity or safety clearances; failure to do so could result in safety hazards. ➤ Assemble the ARO-US per the instructions in this manual. Use care when choosing installation location and adhere to specified cooling requirements. ➤ Unauthorized removal of necessary protections, improper use, incorrect installation and operation may lead to serious safety and shock hazards and/or equipment damage. ➤ In order to minimize the potential of a shock hazard due to hazardous voltages, cover the entire solar array with dark material prior to connecting the array to any equipment.
------------------------------------------------------------------------------------------------	----------------------------------------------------------------------------------------------------------------------------------------------------------------------------------------------------------------------------------------------------------------------------------------------------------------------------------------------------------------------------------------------------------------------------------------------------------------------------------------------------------------------------------------------------------------------------------------------------------------------------------------------------------------------------------------------------------------------------------------------------------------------------------------------------------------

2.5.2 Electrical Connection Warnings

 DANGER	<ul style="list-style-type: none"> ➤ The components in the ARO-US are live. Touching live components can result in serious injury or death. • Do not open the ARO-US except the wire box by qualified persons. • Electrical installation, repairs and conversions may only be carried out by electrically qualified persons. • Do not touch damaged ARO-US. ➤ Danger to life due to high voltages in the ARO-US • There is residual voltage in the ARO-US. The ARO-US takes 20 minutes to discharge • Wait 20 minutes before you open the wire box. ➤ Persons with limited physical or mental abilities may only work with the Growatt ARO-US following proper instruction and under constant supervision. Children are forbidden to play with the Growatt ARO-US. Must keep the Growatt ARO-US away from children.
-------------------------------------------------------------------------------------------------	---------------------------------------------------------------------------------------------------------------------------------------------------------------------------------------------------------------------------------------------------------------------------------------------------------------------------------------------------------------------------------------------------------------------------------------------------------------------------------------------------------------------------------------------------------------------------------------------------------------------------------------------------------------------------------------------------------------------------------------------------------------------------------------------------------------------------------------------------------------------------------------------------

Product description 3



WARNING

- Make all electrical connections (e.g. conductor termination, fuses, PE connection, etc.) in accordance with prevailing regulations. When working with the ARO-US powered on, adhere to all prevailing safety regulations to minimize risk of accidents.
- Systems with ARO-US typically require additional control (e.g., switches, disconnects) or protective devices (e.g., fusing circuit breakers) depending upon the prevailing safety rules.

2.6 Operation Warnings



WARNING

- Anytime the ARO-US has been disconnected from the power network, use extreme caution as some components can retain charge sufficient to create a shock hazard; to minimize occurrence of such conditions, comply with all corresponding safety symbols and markings present on the unit and in this manual.
- Ensure all covers and doors are closed and secure during operation.
- All operations regarding transport, installation and start-up, including maintenance must be operated by qualified, trained personnel and in compliance with all prevailing codes and regulations.
- Although designed to meet all safety requirements, some parts and surfaces of ARO-US are still hot during operation. To reduce the risk of injury, do not touch the heat sink at the back of the PV-ARO-US or nearby surfaces while ARO-US is operating.
- Incorrect sizing of the PV plant may result in voltages being present which could destroy the ARO-US. The Shinephone will read the error message 'PV-Over voltage'. Turn the rotary switch of the DC Disconnect to the Off position immediately. Contact installer.

3.1 ARO-US Overview

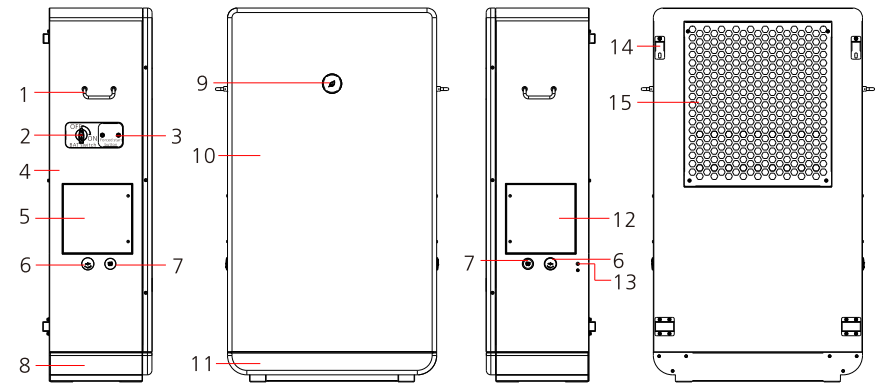

Fig 3.1

- | | | |
|-----------------------------|----------------------------|----------------------------|
| (1) Handle | (2) Box | (3) Base |
| (4) BAT-switch | (5) Power wire outlet hole | (6) Power button |
| (7) Signal wire outlet hole | (8) Left-side wiring box | (9) Front cover |
| (10) LED indicator | (11) Base front cover | (12) Right-side wiring box |
| (13) Ground port | (14) Install ears | (15) Heat sink |

3.2 Information of Label

The labels provide technical information of the ARO-US. You can identify the ARO-US by the label; it is located on the enclosure of the ARO-US. Different type labels can be found on the ARO-US 6.6-19.8H-C 1-US models.

- The type of product (Type/Model).
- Device-specific characteristics.
- Specifications of the ARO-US.
- Requirements of cable & torque.
- Serial number.
- Warning.

3.2.1 Product's label





GROWATT Lithium Ion Battery	
Model/	<input type="checkbox"/> ARO 6.6H-C1-US/ 400 d.c.V/3.5KW/ 6.6kWh/6kWh
Nominal Voltage/ Nominal Power/	<input type="checkbox"/> ARO 9.9H-C1-US/ 400 d.c.V/5.2KW/ 9.9kWh/9kWh
Total Capacity/ Total Energy/	<input type="checkbox"/> ARO 13.2H-C1-US/ 400 d.c.V/5.2KW/ 13.2kWh/12kWh
	<input type="checkbox"/> ARO 16.5H-C1-US/ 400 d.c.V/5.2KW/ 16.5kWh/15kWh
	<input type="checkbox"/> ARO 19.8H-C1-US/ 400 d.c.V/5.2KW/ 19.8kWh/18kWh
Enclosure	IP56
Operation Ambient Temperature	-10°C- +45°C 14°F- +113°F
Max. short Current and Duration	3670A,500µs
Certified to ANSI/CAN/UL STD 1973	
 	
 	
x Made in China	

Fig 3.2

3.2.2 Product's label

CAUTION!

- Risk of Electric Shock, Do Not Remove Cover.
- No User Serviceable Parts Inside ,Refer Servicing To Qualified Service Personnel.
- Risk of Electric Shock from energy stored in capacitor.
- Do not remove cover until 5 minutes after disconnecting all sources of supply.
- Do not use the equipment for purposes not described in its documentation.
- Do not drop,strike,puncture,or step on the equipment.
- The equipment is heavy and cause injury if not handled safely.

CAUTION!

Hot surfaces – To reduce the risk of burns – Do not touch.

CAUTION!

To reduce the risk electric shock and fire – Do not connect to a circuit at more than 150 volts to ground.

MISE EN GARDE!

- Risque de choc électrique, ne retirez pas le couvercle.
- Aucune pièce réparable par l'utilisateur à l'intérieur, confiez l'entretien à un personnel de service qualifié.
- Risque de choc électrique dû à l'énergie stockée dans le condensateur.
- Ne retirez que le couvercle 5 minutes après avoir déconnecté toutes les sources d'alimentation.
- N'utilisez pas l'équipement à des fins non décrites dans la documentation.
- Ne laissez pas tomber, ne heurtez pas, ne perforez pas et ne marchez pas sur l'équipement.
- L'équipement est lourd et peut causer des blessures s'il n'est pas manipulé en toute sécurité.

MISE EN GARDE!

Surfaces chaudes - Pour réduire le risque de brûlures - Ne pas toucher.

MISE EN GARDE!

Pour réduire les risques d'électrocution et d'incendie - Ne connectez pas à un circuit à plus de 150 volts par rapport à la terre.



x **Made in China**

Fig 3.3

Inspection of delivery 4

3.2.3 Labels in the wire box

INVERTER Port Only :

+	-
BAT	

INV	Link in	Link out
BAT		

INVERTER Port Only :

COM
BAT

+	-
BAT-Expansion	

3.3 ARO-US Dimension and Weight

Datasheet	ARO 6.6H-C1-US	ARO 9.9H-C1-US	ARO 13.2H-C1-US	ARO 16.5H-C1-US	ARO 19.8H-C1-US
Dimension (W/D/H)	650*320*1160mm (25.6*12.6*45.7in)		1300*320*1160mm (51.2*12.6*45.7in)		
Weight	105kg/232lb	140kg/309lb	210kg/462lb	240kg/529lb	270kg/596lb

3.4 Transportation

The ARO-US has been fully tested and strictly inspected before delivery. Our batteries leave the factory under appropriate electrical and mechanical conditions. Special packaging ensures safe and careful transportation. However, shipping damage may still occur. In this case, the transportation company is responsible. Please thoroughly inspect the ARO-US before leaving the factory. If you find any damage on the package that the ARO-US may be damaged, or if you find any obvious damage to the ARO-US, please notify the responsible transportation company immediately. If needed, we will be happy to help you. When transporting the ARO-US, the original packaging or equivalent packaging should be used. The maximum number of layers of the original carton is four to ensure safe transportation.

4.1 Unpacking and inspection

The ARO-US is thoroughly tested and inspected strictly before delivery. Our ARO-US leave our factory in proper electrical and mechanical condition. Special packaging ensures safety and careful transportation. However, transportation damage may still occur. The shipping company is responsible in such cases. Thoroughly inspect the ARO-US upon delivery. Immediately notify the responsible shipping company if you discover any damage to the packaging which indicates that the ARO-US may have been damaged or if you discover any visible damage to the ARO-US. We will be glad to assist you, if required. When transporting the ARO-US, the original or equivalent packaging should be used, and the maximum layers for original carton is four, as this ensures safe transport. After opening the package, please check the contents of the box. It should contain the following, Please check all of the accessories carefully in the carton. If anything missing, contact your dealer at once.

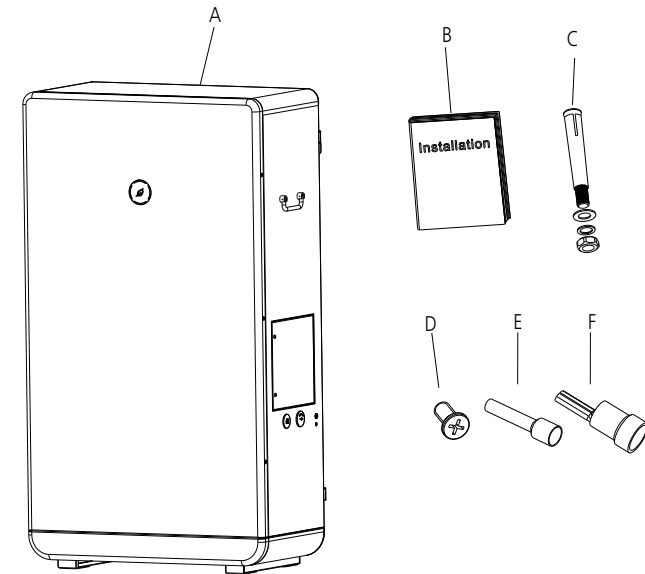





Fig 4.1

Object	Description	Quantity
A	ARO 6.6-19.8H-C1-US	1
B	Installation/ Quick Guide	1
C	M6 Setscrew	2
D	M5 Screw	6
E	BAT+/BAT- terminal	2

5 Instruction

5.1 Safety instruction

 DANGER	<p>Danger to life from electric shock due to high voltages. High voltages are present in the DC cables and later during operation in the conductive components of the ARO-US. These can cause fatal electric shocks.</p>
 DANGER	<p>Danger to life due to fire or explosion . Despite careful construction, electrical devices can cause fires. Do not install the ARO-US on easily flammable materials and where flammable materials are stored.</p>
 WARNING	<p>Risk of burns due to hot enclosure parts. The surface of the ARO-US can become very hot. Touching the surface can result in burns. Do not touch hot surfaces. During operation, do not touch any parts other than the lower enclosure lid of the ARO-US. Mount the ARO-US in such a way that it cannot be touched inadvertently.</p>

5.2 Selecting the installation location

This is the guidance for installer to choose a suitable installation location, and avoid potential damages to device and operators. Rain-tight or wet location hubs that comply with the requirements in the Standard for Conduit, Tubing, and Cable Fittings, UL 514B, are to be used.

The equipment should stand vertically beside the wall. The installation location must be suitable for the weight and size of ARO-US for a long time.

- Select a wall or solid vertical surface that can support the ARO-US.
- Select the installation location so that the status display can be easily viewed.
- Select a well-ventilated location sheltered from direct sunlight and rain.
- Do not install the ARO-US on structures constructed of flammable or thermo labile materials.
- The humidity of the installation location should be 0~100% without condensation.
- The installation location must be freely and safely to access at all times.
- When possible, mount the ARO-US vertically. Never install horizontal and avoids forward and sideways tilt.
- Make sure there is a distance of more than 300mm from ARO 6.6-19.8H-C1-US's front, top, left and right in order to have better heat dissipation when the machine is running.

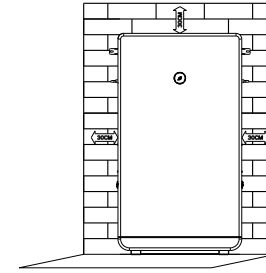

Fig 5.1

- Ensure that the ARO-US is out of the children's reach.
- Don't put any physical item on the ARO-US. Do not cover the ARO-US.
- The location shall be away from strong electromagnetic interference.
- Do not install the ARO-US near television antenna or any other antennas and antenna cables.
- Providing better ventilation for the ARO-US to ensure the heat escape adequately. The ambient temperature should be below 30°C to ensure optimum operation.
- Do not expose the ARO-US to direct sunlight, as this can cause excessive heating and thus power reduction.
- Observe the Min. clearances to walls, other ARO-US, or objects as shown below:

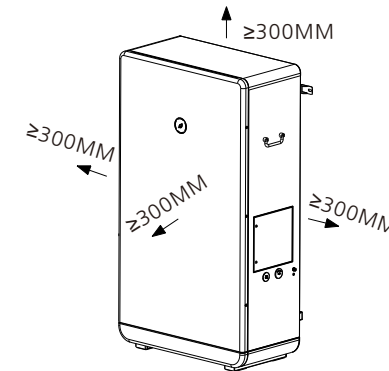

Fig 5.2 Ambient dimensions of one ARO-US

- There must be sufficient clearance between the individual ARO-US to ensure that the cooling air of the adjacent ARO-US is not taken in.
- If necessary, increase the clearance spaces and make sure there is enough fresh air supply to ensure sufficient cooling of the ARO-US.
- The ARO-US can't install to solarization, drench, firm location. We suggest that the ARO-US should be installed at the location with some cover or protection.

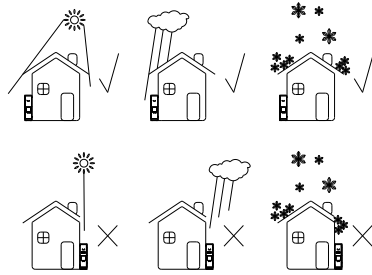

Fig 5.3

➤ Please make sure the ARO-US is installed at the Proper location. The ARO-US can't install close to trunk.

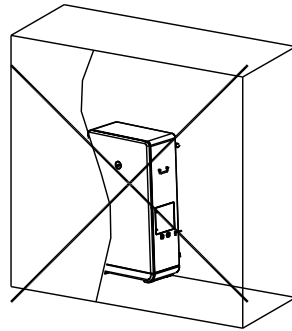

Fig 5.4

5.3 Mounting the ARO-US

5.3.1 Preparatory work



Information

➤ General tools
Personal safety equipment such as gloves, helmet, goggles, ear plugs, safety harness etc.
Step ladders.
Knife.

➤ Tools for mechanical installation.
Equipment for transporting and lifting the ARO-US
Electric(hammer) drill
Hammer
wrenches, sockets and screw bits
Socket driver, screw driver
Tape measure.
Level.
Pencil or other marker.
Fastening screws, plugs, etc.

5.3.2 Fixed the ARO-US on wall



In order to avoid electrical shock or other injury, inspect existing electronic or plumbing installations before drilling holes.

- 1.Remove the ARO 6.6-19.8H-C1-US from the box , rotate the two mounting ears which on ARO 6.6-19.8H-C1-US's back 90 degrees outward.
- 2.Move the ARO 6.6-19.8H-C1-US to the installation position against the wall.
- 3.Draw the expansion bolt's installation position on the wall with the pen.
- 4.Move the ARO 6.6-19.8H-C1-US , and punch the marked location with $\varnothing 8$ drill,and the depth is 50mm, fixed the expansion bolt in the corresponding hole
- 5.Fixed the ARO 6.6-19.8H-C1-US in the expansion bolt's installation position,and tighten the nut.

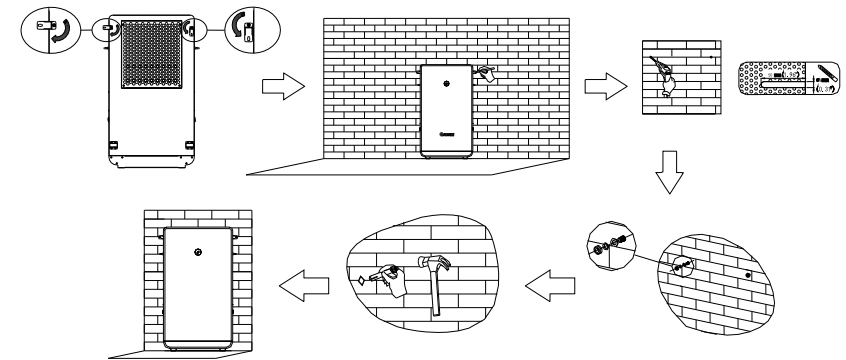

Fig 5.6

5.3.3 Remove ARO' front cover

- 1.Pull out the ARO 6.6-19.8H-C1-US' front cover of the base
- 2.Remove screws on both sides of the door.
- 3.Open the buckle under the door.
- 4.Flip the bottom of the door up, open the door upward.
- 5.Flip the bottom of the door left slowly(attention:Do not pull the cable connected to the door),remove the ground wire screw front door and LED board cable.

Electrical connection 6

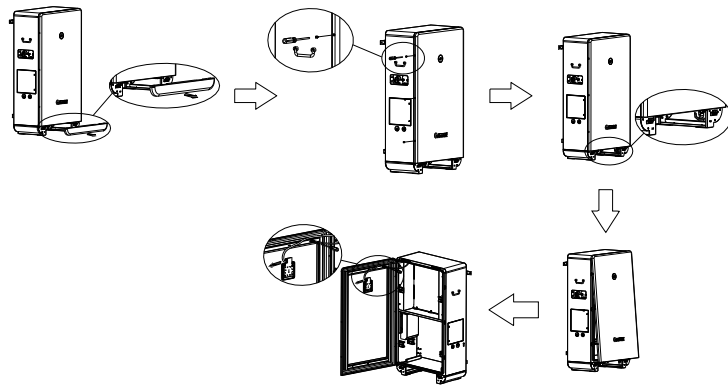



Fig 5.7

5.4 Opening the wiring compartment

 Information	<ul style="list-style-type: none"> ➤ This step may be performed before or after mounting the ARO-US. ➤ General tools.
 Warning	<p>Ensure no live voltages are present on PV input and AC output circuits, and verify that the DC disconnect, AC disconnect, and de-dicated AC branch circuit breaker are in the "OFF" position, before ARO-US installation. Please make sure the internal battery module is in sleep state.</p>

1. Ensure the ARO-US ON/OFF switch is OFF.
2. Loosen the screws of the left junction box cover as shown below.
3. Remove the cover.
4. Open the required BAT and COM Waterproof cover according to the conduits used in the installation.

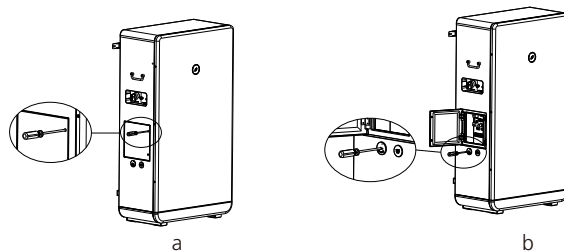





Fig 5.5

6.1 Safety

 DANGER	<p>Do not disconnect the DC connectors under load!</p>
 WARNING	<p>Risk of burns due to hot surfaces The surface of the ARO-US can become very hot. Touching the surface can result in burns. Do not touch hot surfaces. During operation, do not touch any parts other than the lower enclosure lid of the ARO-US. Mount the ARO-US in such a way that it cannot be touched inadvertently.</p>
 DANGER	<ol style="list-style-type: none"> 1. All electrical installations shall be done in accordance with the local and national electrical codes. Do not remove the casing. ARO-US contains no user serviceable parts. Refer servicing to qualified service personnel. All wiring and electrical installation should be conducted by a qualified service personnel. 2. Carefully remove the unit from its packaging and inspect for external damage. If you find any imperfections, please contact your local dealer. 3. Be sure that the ARO-US connect to the ground in order to protect property and personal safety. 4. The ARO-US must only be operated with MIN TL-XH US. Do not connect any other source of energy to it. 5. Energy stored in this equipment's DC link capacitors presents a risk of electric shock. Even after the unit is disconnected from the grid and Battery pack, high voltages may still exist inside the ARO-US. Do not remove the casing until at least 5 minutes after disconnecting all power sources. 6. Although designed to meet all safety requirements, some parts and surfaces of ARO-US are still hot during operation. To reduce the risk of injury, do not touch the heat sink at the back of the PV-ARO-US or nearby surfaces while ARO-US is operating. 7. Before any electrical wiring can be connected to the ARO-US, the ARO-US must be permanently mounted.
 WARNING	<p>Danger of damage to electronic components due to electrostatic discharge. Take appropriate ESD precautions when replacing and installing the ARO-US.</p>

- Connecting the second protective conductor.
- If the installation requires, the earth terminal can be used to connect a second protective conductor or as equipment bonding. This prevents touch current if the original protective conductor fails.
- The battery pack power terminal faces the right side of the cabinet.

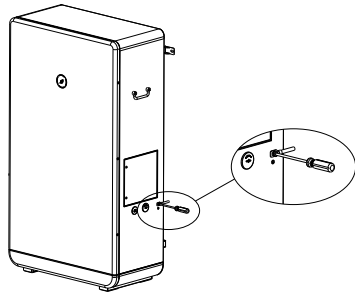

Fig 6.1

Electrical installations

i	All electrical installations must be done in accordance with all local electrical codes and the NATIOAL Electrical Code®, ANSI/NFPA 70. For installation in Canada the installations must be done in accordance with applicable Canadian standards. Before connecting the ARO-US to the power distribution grid, contact your local electric utility company. This connection may be made only by electrically qualified persons.
i	<p>Tools for electrical installation</p> <ul style="list-style-type: none"> • Hexagonal driver 3mm for securing the front cover and AC connector. • Flat screwdriver 3mm for releasing spring terminals. • Cable and wire strippers. • Side cutters. • Crimping tool and cable lugs. • Cable marking equipment. • Digital multi-meter (insulation tester) with DC and AC sensitive current clamp, voltage measurement (max. 1000 VDC) and continuitytesting functions.

6.2 Intended use

Growatt ARO-US are built according to all required safety rules. Nevertheless, improper use may cause lethal hazards for the operator or third parties, or may result in damage to the units and other property.

This unit or system is provided with fixed trip limits and shall not be aggregated above 30 kW on a single Point of Common Connection.

- Convert the low-voltage direct current output from the battery pack into high-voltage direct current. ARO-US can not only release the power of the battery pack but also charge the battery pack.
- Connection system: This 'interface' between Utility and inverter may consist of electrical breaker, fuse and connecting terminals. To comply with local safety standards and codes, the connection system should be designed and implemented by a qualified technician.
- Utility: Referred to as 'grid' in this manual, is the way your electric power company provides power to your place.

6.2.1 Cable requirements



NOTE

Use only solid or stranded wire but not fine stranded wire.
Use cables with high ambient temperatures.
Use cables with a large cross-section.

The maximum allowed wire size for battery cable is 8AWG.
The maximum allowed wire size for battery expansion cable is 5AWG.

6.3 Overview of the connection area

6.3.1 DC HV connection area

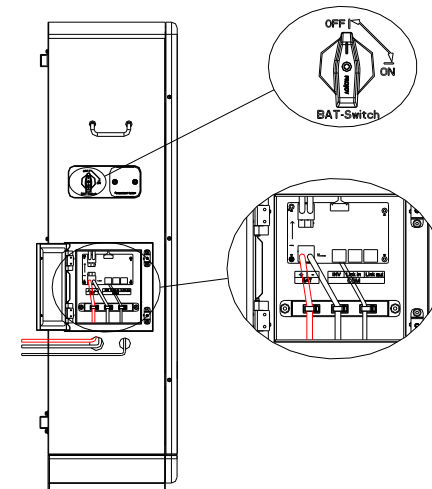

Fig 6.2

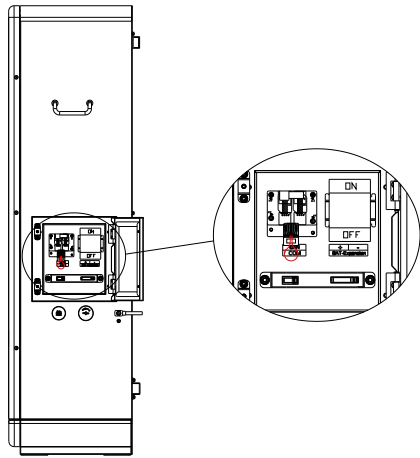

Fig 6.3

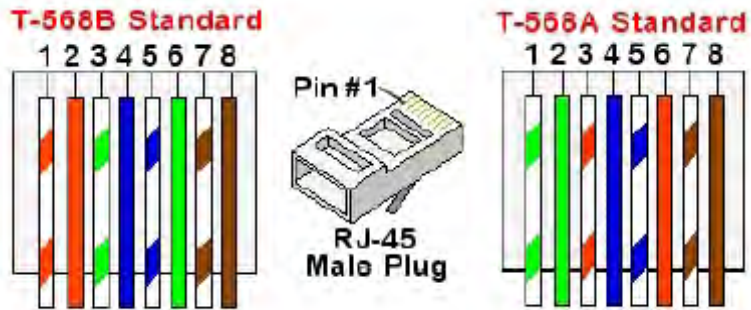

Fig 6.4 Standard cable wiring

CAT5/6 standard cables have eight wires (four twisted pairs), as shown in the diagram below. Wire colors may differ from one cable to another. You can use either wiring standard, as long as both sides of the cable have the same pin-out and color-coding.

- > Insert the conduit into the right side COM drill guide that was opened
- > Insert the CAT 5/6 cable through the conduit to the ARO-US wiring box
- > Remove the cable's external insulation using a crimping tool or cable cutter and expose eight wires
- > Insert the eight wires into an RJ45 connector, as described in Figure 4
- > Use a crimping tool to crimp the connector.
- > Connect the signal cable from the battery to the RJ45 port on the communication board.
- > Keep the wiring box clean.

6.4 Grounding

AC Grounding

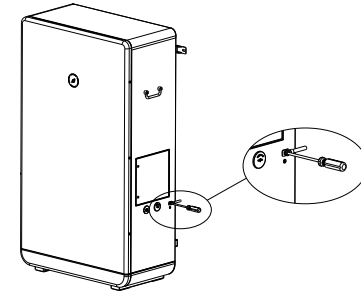

Fig 6.5

Grounding Electrode Terminal (GET)

A grounding electrode terminal may be required to local regulations.

6.5 connection

6.5.1 Battery module connection

6.1.1 Put in the battery pack
Put the battery inside the cabinet (pay attention to the direction of the battery placement, put the power terminal of the battery on the cabinet right). Unscrew the wing nut, Push the battery baffle to the middle and tighten the wing nut. Install the batteries in order from top to bottom.

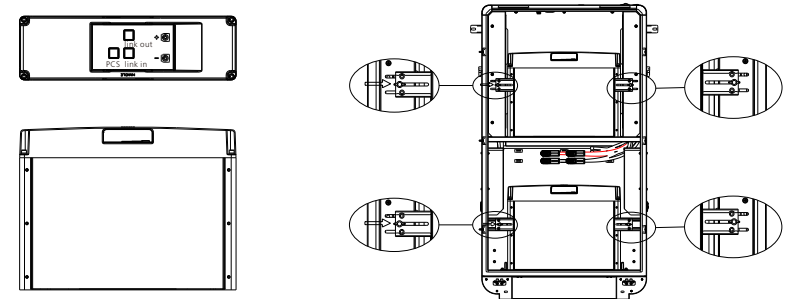

Fig 6.6

6.5.2 Connecting Cables

1. When connecting the battery pack cable, find the cables and cut the cable tie.
2. The LINK-IN port of the upper battery pack needs to be inserted with a shorting cap (battery pack accessory).

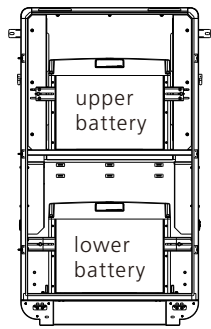

Fig 6.7

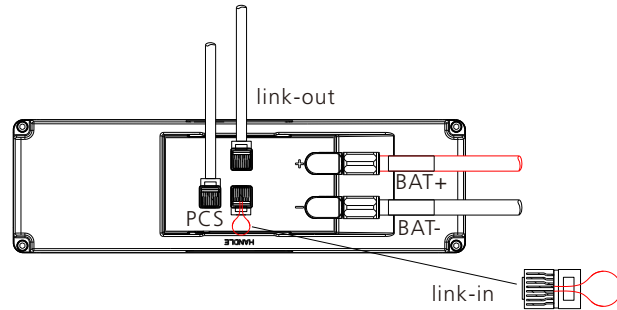

Fig 6.8 upper battery

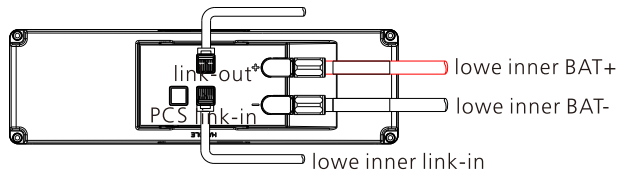

Fig 6.9 low inner battery

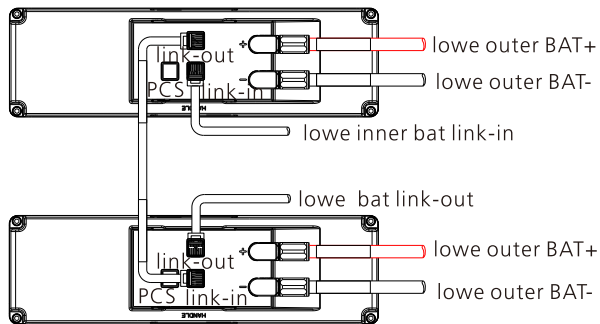





Fig 6.10 low outer battery

 DANGER	<ul style="list-style-type: none"> ➤ Battery short circuits may cause personal injury. The high transient current generated by a short circuit will release a surge of energy and may even cause fire. ➤ To prevent the risk of electric shock, do not connect or disconnect battery cables when the ARO-US is running ➤ Before connecting ARO-US cables, ensure that the DC switch on the ARO-US and all the switches connecting to the ARO-US are in the OFF position, and the ARO-US contains no residual electricity. Otherwise, the high voltage of the ARO-US and Inverter may result in electric shock.. ➤ Exposure to battery voltage can result in serious injury. Use dedicated insulation tools to connect cables.
 WARNING	<ul style="list-style-type: none"> ➤ A battery switch and DC fuse can be configured between the ARO-US and the battery to ensure that the ARO-US can be safely disconnected from the battery. The recommended DC fuse type is littelfuse KLKD 600V/30A. Make sure the battery positive cable connecting to positive fuse holder and positive pole of the switch in series, the battery negative cable connecting to negative fuse holder and negative pole of the switch in series ➤ Make sure the battery cable is connected correctly. That is, the positive and negative terminals of the battery connect to the positive battery terminal and negative battery terminal on the ARO-US respectively. ➤ Do not connect loads between the ARO-US and the battery. ➤ Since the ARO-US is transformer-less, the battery connected to the ARO-US cannot be grounded, ensure that the battery output is well insulated to ground.
 NOTE	<ul style="list-style-type: none"> ➤ The cable distance between the Inverter and the ARO-US should be less than or equal to 10 meters, ideally less than 5meters. ➤ If the power cables are not installed or routed as required, the positive or negative terminal of the ARO-US may be short-circuited to ground ,an AC or DC short circuit may occur and damage the ARO-US and.

7 Commissioning

 DANGER	High voltages in the Battery system Risk of death or serious injury due to electric shock Only electrically skilled persons may perform work on the Battery.
 WARNING	Read all of these instructions, cautions, and warnings for the ARO-US series inverter and associated PV array documentation. Installation and commissioning must be performed by a licensed electrician.
 CAUTION	Disconnect in the "OFF" position, verify the PV input polarity once more simply by carefully using a 600 V, DC rated digital volt meter and probing the positive (+) and negative (-) PV array connections.

7.1 Checking Before Power-On

No.	Check Item	Acceptance Criteria
1	ARO-US installation	The ARO-US is installed correctly, securely, and reliably
2	Cable layout	Cables are routed properly as required by the customer.
3	Cable tie	Cable ties are secured evenly, with no sharp protrusions.
4	Grounding	The ground cable is connected correctly, securely, and reliably.
5	Switches	The DC switch are in the OFF position.
6	Cable connections	The DC output power cable, battery cable, and signal cable are connected correctly, securely, and reliably.
7	Unused terminals and ports	Unused terminals and ports are fitted with waterproofing bolts or watertight caps.
8	Cable routing pipe sealing	All cable routing pipes at the bottom of the enclosure are sealed.
9	Cleanliness in the maintenance compartment	The maintenance compartment interior is clean and tidy.
10	Installation environment	An appropriate installation space has been chosen, and the installation environment is clean and tidy.
11	ATL battery module	Confirm the sleep status of the ATL battery module, and most of the LEDs are off

7.2 Powering on the system

case1:If the inverter has PV access or mains accessing, or both PV and mains accessing, the steps of ARO-US 6.6-19.8H-C1-US accessing to energy storage system are as follows:

1. Turn on the BAT-switch on the left side of the ARO-US 6.6-19.8H-C1-US;
 2. Open the wiring box on the right side and close the BAT-Expansion circuit breaker (optional, if there has battery expansion) ;
 3. Turn on the PV switch or the mains switch of the inverter, or turn on the PV switch and the mains switch at the same time; waiting for 10S, the inverter will send a wake-up signal to run the ARO-US 6.6-19.8H-C1-US. By observing the LED indicator in the middle of the ARO-US 6.6-19.8H-C1-US cabinet door, confirm that the machine enters the discharge state (refer to 7.1 for the LED indicator description), indicating that ARO-US 6.6-19.8H-C1-US has been successfully started by the inverter.
- Case2:If the inverter has no PV accessing and no mains accessing, the steps of ARO-US 6.6-19.8H-C1-US accessing to energy storage system are as follows:
1. Turn on the BAT-switch on the left side of the ARO-US 6.6-19.8H-C1-US;
 2. Open the wiring compartment on the right side and close the BAT-Expansion circuit breaker (optional, if there has battery expansion);
 3. Press and hold power button $\geq 3S$, $\leq 10S$ (please refer to item 8 for power button operation), and observe the LED indicator in the middle of the cabinet door until the middle green LED flashes quickly, then you can release the button. Wait for 10S, observe the LED indicator, and confirm that the machine enters the discharge state (refer to 7.1 for LED indicator description), indicating that ARO-US 6.6-19.8H-C1-US has been manually forced to start successfully.

7.3 LED description

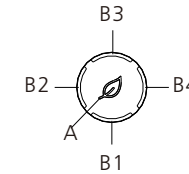

A: Middle indicator(indicate status)
B: Ring indicator(indicate batter power)

LED lights are displayed as follows in ARO-US 6.6-19.8H-C1-US different states:

number	ARO-US 6.6-19.8H-C1-US status	LED light display	Remarks
1	Manual forced Power on state	Middle green light flashing (0.1 seconds on and 0.1 seconds off) indicate that the manual forced start is starting. Ring indicator indicate : 1) power $\leq 25\%$, LED B1 is on, LED B2/B3/B4 are off; 2) power $\leq 50\%$, LED B1/B2 are on, LED B3/B4 are off; 3) power $\leq 75\%$, LED B1/B2/B3 are on, LED B4 are off; 4) power $> 75\%$, LED B1/B2/B3/B4 are on;	The force power on button to be pressed continuously for $\geq 3S$, $\leq 10S$, the button needs to be released when the green light flashes (0.1 seconds on and 0.1 seconds off);

2	Standby state	Middle green light flashing (0.5 seconds on and 2 seconds off) indicate the standby state ; Ring indicator indicate : 1) power≤25% , LEDB1 is on, LED B2/B3/B4 are off ; 2) power≤50% , LEDB1/B2 are on, LEDB3/B4 are off ; 3) power≤75% , LEDB1/B2/B3 are on, LEDB4 are off ; 4) power > 75% , LEDB1/B2/B3/B4 are on ;
3	Charge state	Middle green light is on , Ring indicator indicate : 1) power≤25% , LEDB1 flashes, LED2/3/4 are off; 2) power≤50% , LEDB1 is on, LEDB2 flashes, LEDB3/B4 are off; 3) power≤75% , LEDB1/B2 are on, LEDB3 flashes, LEDB4 is off; 4) power > 75% , LEDB1/B2/B3 are on, LEDB3 flashes;
4	Discharge state	Middle button green light is on , Ring indicator indicate : 1) power≤25% , LEDB1 is on, LEDB2/B3/B4 are off; 2) power≤50% , LED1/2 are on, LEDB3/B4 are off; 3) power≤75% , LEDB1/B2/B3 are on, LEDB4 is off; 4) power > 75% , LEDB1/B2/B3/B4 are on ;
5	Alarm state	Middle green light flashes (0.5 seconds on and 0.5 seconds off , 0.5 seconds on and 2 seconds off)indicate that the alarm state ; Ring indicator indicate : 1) power≤25% , LEDB1 is on, LEDB2/B3/B4 are off; 2) power≤50% , LEDB1/B2 are on, LEDB3/B4 are off; 3) power≤75% , LEDB1/B2/B3 are on, LEDB4 is off; 4) power > 75% , LEDB1/B2/B3/B4 are on ;

6	Fault state	Middle red light flashes (1 second on and 1 second off)indicate that the fault state ; Ring indicator indicate : 1) power≤25% , LEDB1 is on, LEDB2/B3/B4 are off; 2)power≤50% , LEDB1/B2 are on, LEDB3/B4 are off; 3)power≤75% , LEDB1/B2/B3 are on, LEDB4 is off; 4)power > 75% , LEDB1/B2/B3/B4 are on ;
7	Manual forced shut down state (Manual forced shut down state only turn machine from normal state to standby state, BAT stop out putting high voltage)	Middle red light flashing (0.1 seconds on and 0.1 seconds off) indicate that the manual shut down is starting ; Ring indicator indicate : 1) power≤25% , LEDB1 is on, LEDB2/B3/B4 are off; 2)power≤50% , LEDB1/B2 are on, LEDB3/B4 are off; 3) power≤75% , LEDB1/B2/B3 are on, LEDB4 is off; 4)power > 75% , LEDB1/B2/B3/B4 are on ;
8	Upgrade state	Middle yellow light flashes (1 second on and 1 second off)indicate that the upgrade state ; Ring indicator indicate: 1) power≤25% , LEDB1 is on, LEDB2/B3/B4 are off; 2)power≤50% , LEDB1/B2 are on, LEDB3/B4 are off; 3)power≤75% , LEDB1/B2/B3 are on, LED4 is off; 4)power > 75% , LEDB1/B2/B3/B4 are on ;

7.4 Powering off the system

If the ARO 6.6-19.8H-C1-US to be forced to turn off under normal charging and discharging state, you can press and hold Power button $\geq 3S$, $\leq 10S$ (please refer to item 7.5 for power button operation), and at the same time observing the LED in the middle of the door, until the middle LED changes from green light ON to red light flashing quickly, the button can be released.

Wait for 10S, observe the LED indicator, and confirm that the machine enters the standby state (see 7.3 for LED indicator description), indicating that ARO 6.6-19.8H-C1-US has been manually forced to shut down successfully. Then turn off BAT-Switch (Please refer to the accessory manual of the ATL battery module, for the operating instructions of the ATL battery module).

7.5 Button

Forced start/shut down ARO-US 6.6-19.8H-C1-US power supply steps:

1. Disengage the captive screws of cover of the forced start button with Phillips screwdriver.

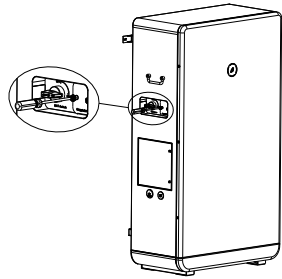

Fig 7.1

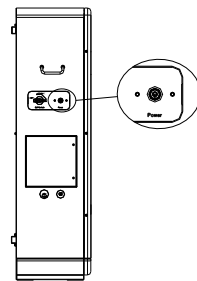

Fig 7.2

2. Press and hold the button with your finger, see 7.22 and 7.3 for the button holding time.

- > Before the system is powered on, long press the button for 3s~6s, the internal battery module and ARO will be awakened, and the LED on the front door will light up.
- > Long press again for 6s~10s until the leaf-shaped light on the front door flashes quickly, the ARO high voltage DC output will be turned on.
- > When the system is running, press and hold for 6s~10s until the leaf-shaped light on the front door flashes quickly, the ARO high voltage DC output will be turned off.

3. After the forced start/shut down is successful, install the cover back removed in the first step.

8.1 Storing the ARO-US

Store the ARO-US in a dry place where ambient temperatures are always between $-20-45^{\circ}C$ / $-4-+113^{\circ}F$.

8.2 Disposing of the ARO-US



Do not dispose of faulty ARO-US or accessories together with household waste. Please accordance with the disposal regulations for electronic waste which apply at the installation site at that time. Ensure that the old unit and, where applicable, any accessories are disposed of in a proper manner.

9 Growatt Warranty

Please refer to the warranty card.

10 Technical Data

10.1 Specification

Datasheet	ARO-US 6.6H-C1-US	ARO-US 9.9H-C1-US	ARO-US 13.2H-C1-US	ARO-US 16.5H-C1-US	ARO-US 19.8H-C1-US
Battery Data					
Energy Capacity	6.6kWh	9.9kWh	13.2kWh	16.5kWh	19.8kWh
Capacity	64Ah*2	64Ah*3	64Ah*4	64Ah*5	64Ah*6
Battery Type	LFP (LiFePO4)				
Nominal Voltage	400V				
Operating Voltage Range	360-480V				
MaxCharging/ Discharging Current	9.7A@360V 13.5A@360V	14.3A@360V	14.3A@360V	14.3A@360V	14.3A@360V
MaxCharging/ Discharging Power	3500W/ 3500W	5200W/ 5200W	5200W/ 5200W	5200W/ 5200W	5200W/ 5200W
General Data					
Dimension(W/D/H)	650*320*1160mm (25.6*12.6*45.7in)		130*320*1160mm (51.2*12.6*45.7in)		
IP Protection	IP56/NEMA Type 4X				
Weight	105kg/232lb	140kg/309lb	210kg/462lb	240kg/529lb	270kg/596lb
Working Temperature	-10+50°C / 14-122°F				
Storage Temperature	-20-45°C / -4-+113°F				
Features					
DoD	90%				
Cycle Life	≥6000 cycle				
BMS Monitoring Parameters	SOC, System voltage, current, cell voltage, cell temperature, PCBA temperature measurement				
Communication Port	RS485/CAN				
Warranty	10 Years				
Certification	UL1973/IEC62619 (Cell & Pack) / UN38.3+PI965				

10.2 Ambient temperature

The ARO-US can be operated in an ambient temperature from -10+50°C / 14-122°F. The ARO-US US series ARO-US operate at full power and full currents up to a certain temperature, above which they may operate with reduced ratings to prevent device damage. The following diagram illustrates how the output power of the solar ARO-US is reduced automatically in accordance with ambient temperature.

The device should be installed in a well-ventilated, cool and dry location.

Due to tolerance of temperature sensor and ARO-US efficiency difference under different battery voltage, this derating curve may be a little different from each.

Contact 11

If you have technical problems about our products, contact the GROWATT Serviceline. We need the following information in order to provide you with the necessary assistance:

- ARO-US type
- Serial number of the ARO-US
- Event number or display message of the ARO-US
- Type and number of PV modules connected
- Optional equipment

Growatt USA, Inc

9227 Reseda Blvd, #435 Northridge, CA 91324, USA.

- T** +818 800-9177
- E** usaservice@ginverter.com
- W** www.growatt-america.com