

COLOR	PT# SUFFIX
BLACK	-BK
WHITE	-WH
GREY	-GY

NO.	NOTE	DESCRIPTION	QTY
1	1844-005	WALL SUPPORT 24" WELD ASSY	1
2	1305031033	J-BOLT - 5/16-18 x 2" (3" O.A.)	2
3	5/16-18	HEX. NUT 5/16-18	2
4	5/16	LOCK WASHER	2

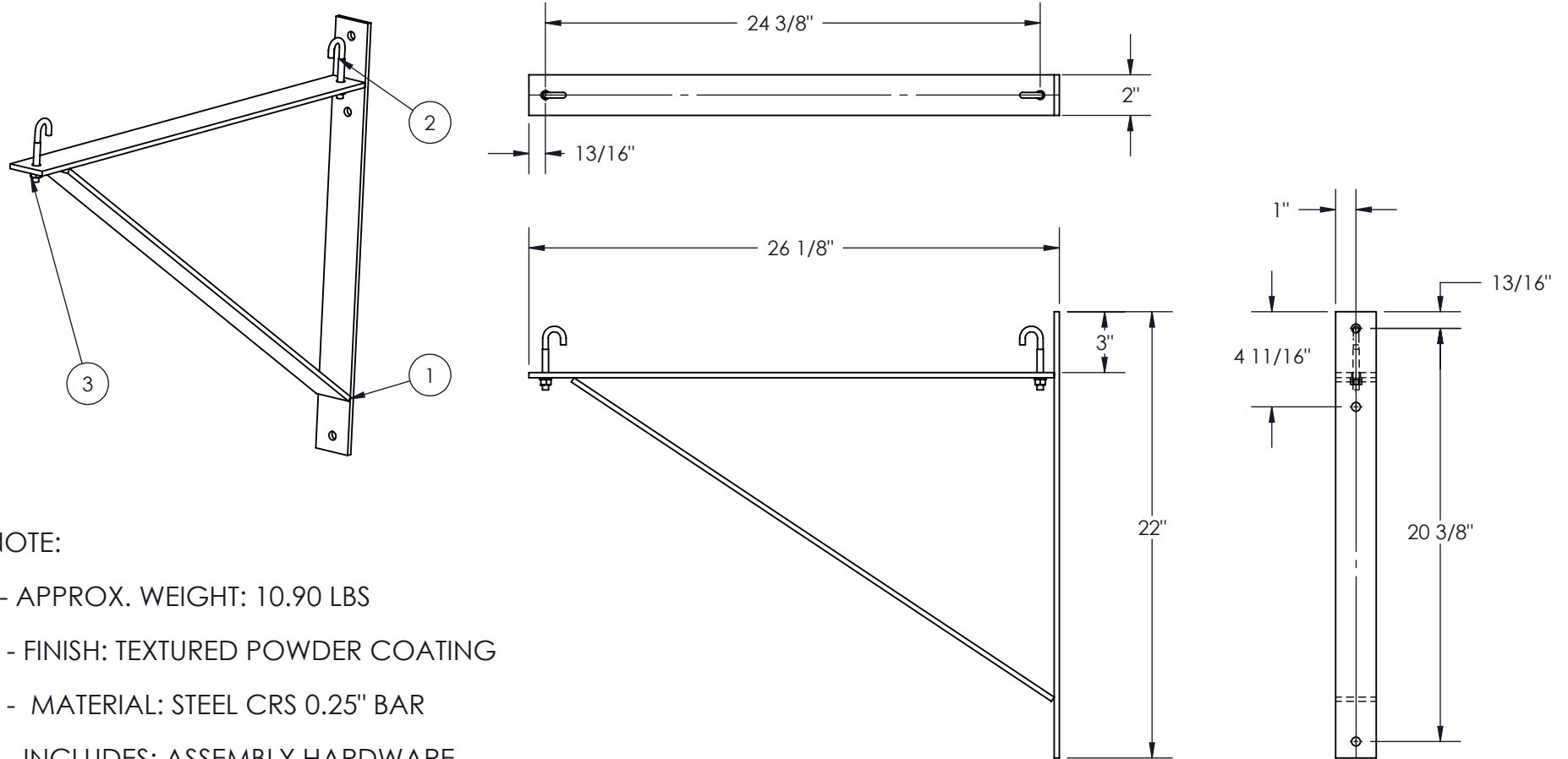

NOTE:

- 1 - APPROX. WEIGHT: 10.90 LBS
- 2 - FINISH: TEXTURED POWDER COATING
- 3 - MATERIAL: STEEL CRS 0.25" BAR
- 4 - INCLUDES: ASSEMBLY HARDWARE
- 5 - BAG AND SHIP HARDWARE LOOSE.



PROPRIETARY AND CONFIDENTIAL
 THE INFORMATION CONTAINED IN THIS DRAWING IS THE SOLE PROPERTY OF ELECTRON METAL A.I.G. INC. ANY REPRODUCTION IN PART OR AS A WHOLE WITHOUT THE WRITTEN PERMISSION OF A.I.G. ELECTRON METAL INC IS PROHIBITED.

DRAWN BY:
R.B
 CHECKED BY:
R.B

Title:
TRIANGLE WALL SUPPORT 24"

FILE:
TriangleWallSupport24_1844-006_Eng

APPROVED BY:
E.D.

PART NO.:
CABLRW-2400

DRAWING NO.:
1844-006

REV.:
A

SCALE:
1:4

DATE:
2017-04-18

SHEET:
1 / 1