

NO.	NOTE	DESCRIPTION	QTY
1	.375-16 x 4.5	THREADED ROD	1
2	TIGE 3/8", TROU 3/4"	EXPANSION SHIELD HD	1
3	.375 ID, 1.5 OD	WASHER, EXTRA WIDE (FENDER)	3
4	3/8-16	HEX NUT 3/8-16	3
5	1305021667	NYLON WASHER	1
6	1540	NYLON BUSHING	1
7	3/8"	SPLIT LOCK WASHER 3/8"	1

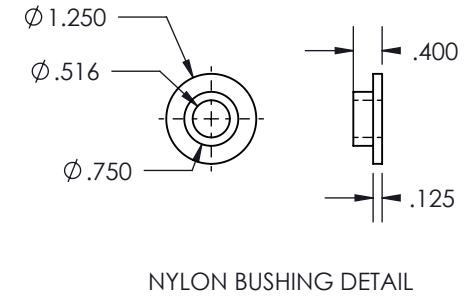
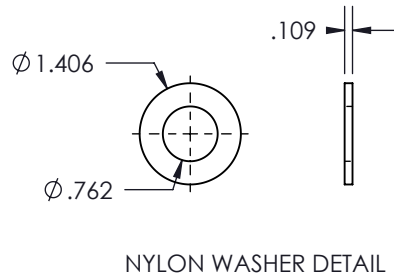
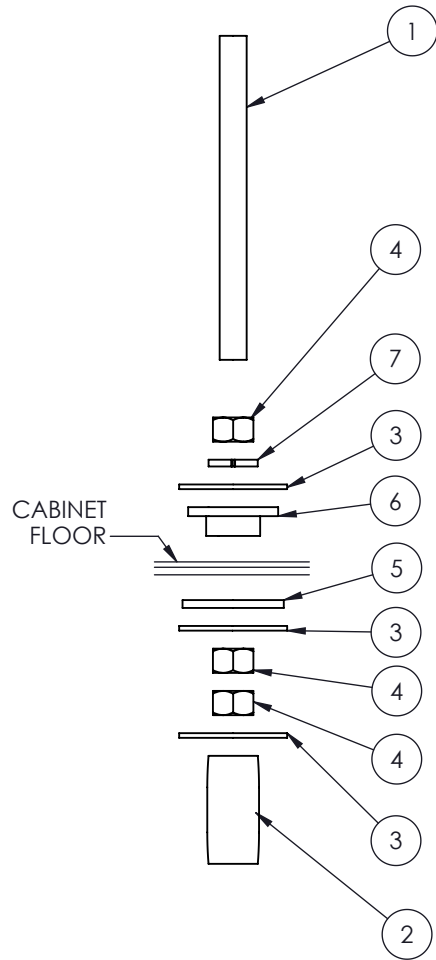

NOTES:

1- EACH KIT CONTAINS 4 ASSEMBLIES AS SHOWN ON THIS DRAWING.

VERSION FRANÇAISE RECTO-VERSO

REV.	DESCRIPTION	DATE	APPR.
C	3/4" HOLE WAS .625" HOLE	2011-05-30	E.D.
REVISIONS			



PROPRIETARY AND CONFIDENTIAL
 THE INFORMATION CONTAINED IN THIS DRAWING IS THE SOLE PROPERTY OF ELECTRON METAL A.I.G. INC. ANY REPRODUCTION IN PART OR AS A WHOLE WITHOUT THE WRITTEN PERMISSION OF A.I.G. ELECTRON METAL INC IS PROHIBITED.

DRAWN BY: E.D.	Title: ISOLATED ANCHORING KIT 4 RODS SLAB FLOOR		
CHECKED BY: E.D.			
PROJECT: G:\SWDwgs\Bell\Accessories\FeetCastersAnchors\	FILE: IsolationKitSlabON_12700		
PART NO: AN4CRS-061609	DRAWING NO: 12700	REV.: C	SCALE: 3:8
		DATE: 2005-03-23	SHEET: 1 / 2

APPROVED BY:

NO.	DESSIN/FOURNISSEUR	CFG/NO. FOURNISSEUR	DESCRIPTION	QTÉ
1	FASTENAL	.375-16 x 4.5	TIGE FILETÉE	1
2	KC INDUSTRIEL	.375 BOLT .75 HOLE	TAMPON D'EXPANSION ROBUSTE	1
3	ATTACHES RICHARD	0.375	RONDELLE, EXTRA LARGE (FENDER)	3
4	FASTENAL	.375-16	ÉCROU HEX 3/8-16	3
5	FASTENAL	0.750"	RONDELLE EN NYLON	1
6	1540	Default	BAGUE NYLON	1
7	TECHNI-VIS	*.375	RODELLE DE BLOCAGE FENDU 3/8"	1

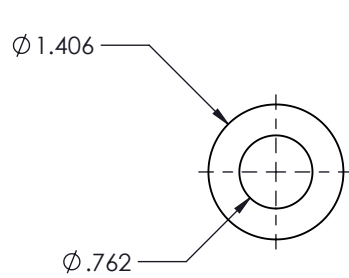
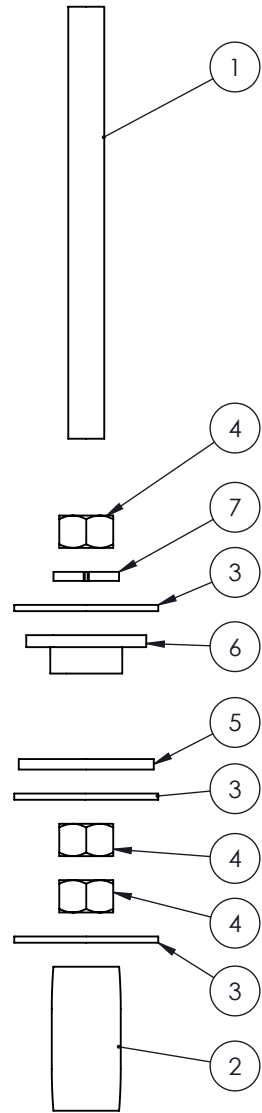

DÉTAIL RONDELLE EN NYLON

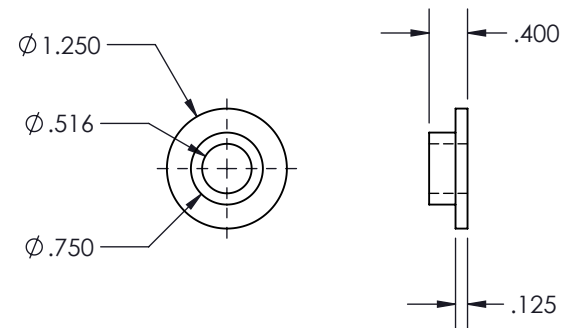

DÉTAIL BAGUE EN NYLON

NOTES:

1 - CHAQUE ENSEMBLE INCLUS 4 ASSEMBLAGE TEL QUE ILLUSTRÉ SUR CE DESSIN

ENGLISH VERSION RECTO-VERSO

 <p>FABRIQUÉ AVEC FIERTÉ AU QUÉBEC.</p> <p>CONFIDENTIEL L'INFORMATION CONTENUE DANS CE DESSIN EST L'ENTIÈRE PROPRIÉTÉ D'ELECTRON METAL A.I.G. INC. TOUTE REPRODUCTION PARTIELLE OU EXHAUSTIVE SANS PERMISSION ÉCRITE D'ELECTRON METAL A.I.G. INC. EST INTERDITE.</p>	DESSINÉ PAR/DRAWN BY: E.D.	Title/Titre: ANCRAGE ISOLÉ 4 TIGES POUR DALLE							
	VÉRIFIÉ PAR/CHECKED BY: E.D.								
APPROUVÉ PAR:	PROJET/PROJECT: G:\SWDwgs\Bell\Accessories\FeeTCastersAnchors\	NO. DE PIÈCE/PART NO.: AN4CRS-061609		FICHER/FILE: IsolationKitSlabON_12700	NO. DE DESSIN/DRAWING NO.: 12700	RÉV./REV.: C	ÉCHELLE/SCALE: 1:2	DATE: 2005-03-23	PAGE/SHEET: 2 / 2