



H₂ Series

Vesta H₂, Athena H₂, Melody II



Warning! Incorrect installation and/or operation could void your valuable warranty.
Please protect your investment! READ THIS MANUAL CAREFULLY!



STOP

Read Me First / Quickstart Guide

- Step One:** Watch the Installation Video at alkaviva.com/h2-videos
- Step Two:** Test your Tap Water
- Step Three:** Install your Ionizer
- Step Four:** Validate your Warranty within 30 days of purchase (US Customers)
- Step Five:** Enjoy your Water!

IMPORTANT NOTES:

- If your ionizer is wet, some residual water may be present. Water is run through every machine for quality control and testing purposes.
- If you have well water - before you use your ionizer, it is critical that a water test is completed to ensure your water is potable (safe for drinking) and suitable to work with an ionizer. For testing, please visit: alkaviva.com/professional-testing
- If you are using an Undersink Conversion Kit, please see Installation Requirement below.
- Installation Requirement: For undersink installations, or installations directly connected to the cold water line (versus countertop installation connected to your faucet with a diverter), AlkaViva requires installation be performed by a qualified, licensed and bonded professional plumber or contractor. AlkaViva will not be held responsible for any damages caused by improper installation.

When having a professional install your ionizer, we recommend that you email techsupport@alkaviva.com at least 48 hours in advance to ensure a technician will be available during your installer's visit. Our office hours at 8 AM - 5 PM (Pacific Time), Mon - Fri.

- If you have a water softener, do not use your ionizer with a sodium or potassium based ion-exchange softening system without first consulting with your AlkaViva Dealer or Technical Support.
- Iron will cause major damage to your ionizer. Orange stains in your plumbing indicates iron in your water supply. If you have any indication of iron in your water supply, do not use your ionizer without first consulting with your AlkaViva Dealer or Technical Support
- Remove the film on the display of your unit.
- Check your filters. They may have come loose during shipment. Refer to this Owner's Manual and check your filters prior to use.
- If you choose to install your ionizer under the counter as described in this manual, ONLY use the AlkaViva approved Undersink Kit (double spouted faucet). Never use a single spout faucet, this will damage your ionizer and void your warranty.

Should you require assistance with your ionizer, fill out the ionizer repair and support form at:
alkaviva.com/repairs

DO NOT ATTEMPT TO REPAIR YOUR WATER IONIZER! DOING SO WILL VOID YOUR WARRANTY!

Table of Contents

Congratulations on Your New Purchase & Register your Warranty.....	1
Important Safety Warnings and Precautions.....	2
How to Protect Your Investment & Warranty.....	3
Let's Take a Tour of Your New Ionizer.....	4
Overview of the Control Panel.....	5
Installation Procedure (Methods 1, 2, and 3).....	7
Operating Your Ionizer.....	9
Manually Adjusting the Power.....	11
Ionizer Performance Factors.....	12
Using Alkaline, Ionized Water.....	13
Replacing the H ₂ Series Smart Filter.....	16
How to Add Optional Calcium Inserts.....	17
How to Add Optional Inline Sediment Filter.....	17
Operating the Quick Connect Fitting.....	17
Troubleshooting.....	18

Congratulations on Your New Purchase!

Your new H₂ Series ionizer is designed to provide you with many years of the cleanest, healthiest and most functional water available. There are many specific uses and benefits of this amazing water, so read this manual carefully to learn how to install, maintain, protect and get optimum performance out of your investment.

Your new H₂ Series Ionizer produces filtered alkaline, ionized, and hydrogen-rich water. Just exactly what is that? Your ionizer employs computer accurate and selectable magnetic energy to perform electrolysis through platinum titanium electrodes inside a water cell. Inside this advanced cell, the magnetic energy separates the water into alkaline (high pH) and acidic (low pH) stream and enriches the water with dissolved molecular hydrogen without using any chemicals.

Ionizing the water also binds extra oxygen molecules, and concentrates ionized, absorbable and beneficial minerals like calcium, magnesium and potassium.

Your new H₂ series ionizer also produces acidic water. This type of water has a low pH (less than pH 6) and has many excellent uses. You now have the convenience and benefits of ionized water that functions in many ways that ordinary tap, filtered or bottled water simply cannot.

Make sure you register your ionizer warranty within 30-days of purchase. To activate your Limited Lifetime Warranty, go to www.alkaviva.com/warranty

Enjoy your H₂ Series water ionizer!



Prior to installation, it is very important that you read through and adhere to each of these safety warnings & precautions.

- Always plug your ionizer into an appropriate outlet that is installed in accordance with all local codes and ordinances. Use a grounded outlet. Do not plug in your ionizer where it will exceed the rating of the outlet or electrical wiring. Failure to comply can result in fire, injury and/or damage to your electrical wiring, your ionizer, or yourself!
- NEVER attempt to repair or service the unit yourself. Attempting to do so will void your valuable warranty! Contact AlkaViva to arrange service or repair.
- If your ionizer becomes submerged in water, unplug the power cord from the wall before removing the ionizer from the water. Failure to do so may cause electric shock!
- Your ionizer uses a free voltage feature. This means that your ionizer will operate on 120v or 220v power supplies. Be sure to use the appropriate adapter for your outlet if needed.
- NEVER touch the power cord or plug with wet hands - this may result in electric shock!
- Do not wash your ionizer by immersion or by pouring water over the main body; always unplug your ionizer while cleaning the casing. Clean with damp sponge or cloth.
- Ensure the power plug is firmly and properly inserted into the outlet - failure to do so may result in electric shock or fire!
- Keep the power cord and your ionizer away from hot surfaces or appliances - failure to do so may result in electric shock, fire, or damage to the ionizer!
- Never insert foreign objects into your ionizer.
- Do not operate your ionizer with a damaged power cord or plug or insert into a faulty or worn outlet.
- Always unplug your ionizer when changing a fuse or cleaning your ionizer. Failure to do so may result in an electric shock!
- Do not run hot water through your ionizer. Doing so will damage your filters.
- Protect your ionizer from freezing temperatures and direct sunlight.
- Install your ionizer only on a level, hard surface.
- Do not put anything heavy on top of your ionizer,
- Do not use benzene, paint thinner or insecticidal sprays for cleaning your ionizer. Doing so can damage the finish.
- Do not close, bend, pinch, press or otherwise obstruct output ports or tubing.
- If the appliance makes strange or unusual noises or odors, unplug the power cord immediately and contact AlkaViva Customer Service.
- Unplug your ionizer if you plan not to use it for an extended period. Store your filters in a plastic bag inside of your refrigerator to prevent bacterial growth. Filter replacement may be necessary when you use it again.
- Your ionizer is NOT under warranty for any damage caused by hard water.
- Do not use an ionizer downstream of any ion exchange water softening system or reverse osmosis system without first consulting AlkaViva Customer Service.
- Make sure to use your ionizer only with potable water which is suitable for human consumption.
- DO NOT use your ionizer with well water, water with extreme hardness, high sediment or TDS levels without first contacting AlkaViva Customer Service.

How to Protect your Investment & Warranty

**Your H₂ Series includes a hard water test strip.
Test your tap water BEFORE you install your ionizer.**

Important! Hard Water Information

The H₂ Series ionizers have the most advanced cleaning system available, DARC II.





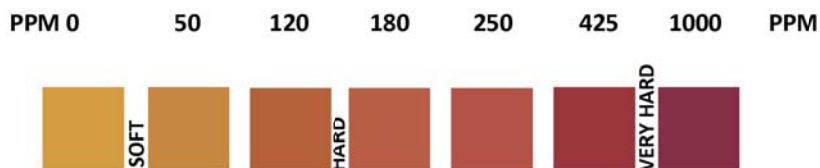

The DARC II cleaning system does an amazing job of protecting the critical components of your ionizer, but cannot reach all the internal plumbing inside of an ionizer. Which can also be susceptible to hard water damage called scale. Hard water damage will not only degrade performance, it will void your warranty.

To protect you and your ionizer, read the following information carefully and be sure to test your water.

Instructions:

1. Dip the hard water test strip into a water sample for 3 seconds.
2. Remove - DO NOT SHAKE.
3. Wait 20 seconds, and then match with the closest color block. Colors are stable for one minute.



If test strip is this color:		You need to order:
	50 ppm or less	We Recommend UltraWater Filter
	51 ppm to 120 ppm	EOS Scale Guard Inline Filter
	121 ppm to 180 ppm	
	181 ppm to 250 ppm	
	251 ppm to 425 ppm	AlkaViva Ultra Spartan
	Over 426 ppm	AlkaViva Reverse Osmosis System with Re-mineralizing Filter

If you have any questions, we're happy to help. Call AlkaViva at (775) 324-2400.

Let's Tour your New H₂ Series Ionizer

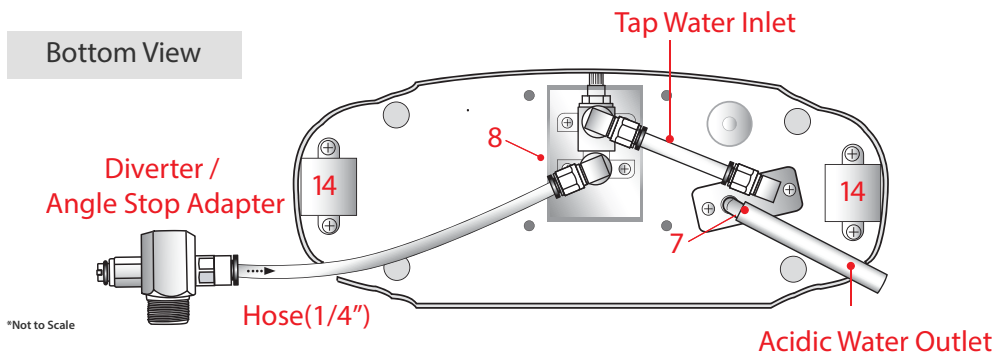
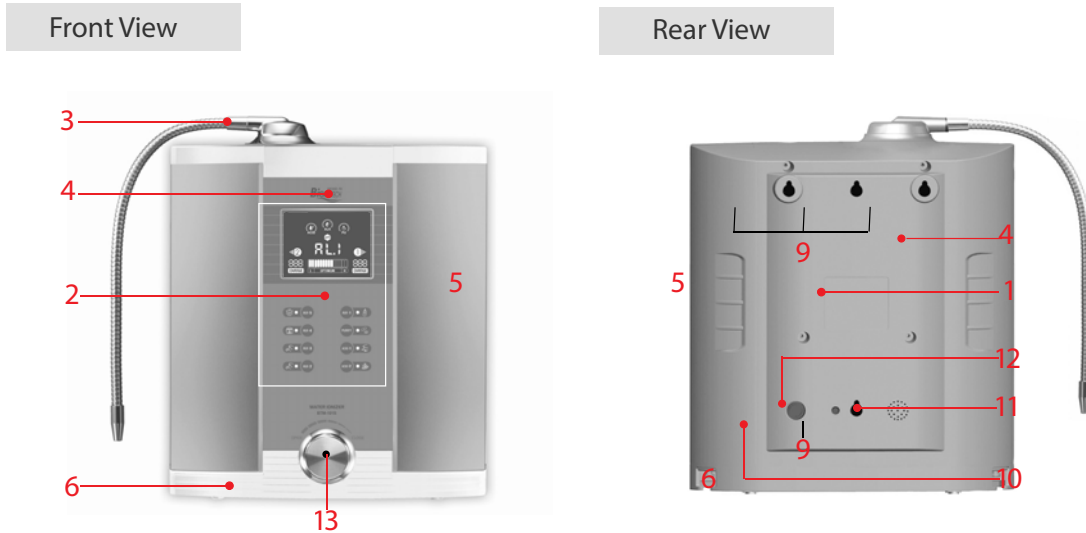

#	Name	Description
1	Back Panel	Covers the back of the ionizer.
2	Control Panel	Function controls and display. Detailed on next page.
3	Flexible Stainless Steel Spout	Outlet for either alkaline or acidic water (user-selected).
4	Front Panel	Covers the front of the ionizer.
5	Filter Cover	Remove this panel to change filters.
6	Bottom Panel	Covers bottom of the ionizer.
7	Acidic Water Outlet	For acidic water. Labeled with red sticker.
8	Water Inlet	Tap water supply. Labeled with black sticker.
9	Key-hole Slots	For wall mounting.
10	Fuse Holder	Fuse.
11	Audio Speaker	Transmits voice and melody.
12	Audio Volume Control	Volume control.
13	Flow Control Valve	On/Off and water flow adjustment.
14	Locking Device	Filter cover safety lock. Depress when removing filter cover.

Overview of the Control Panel

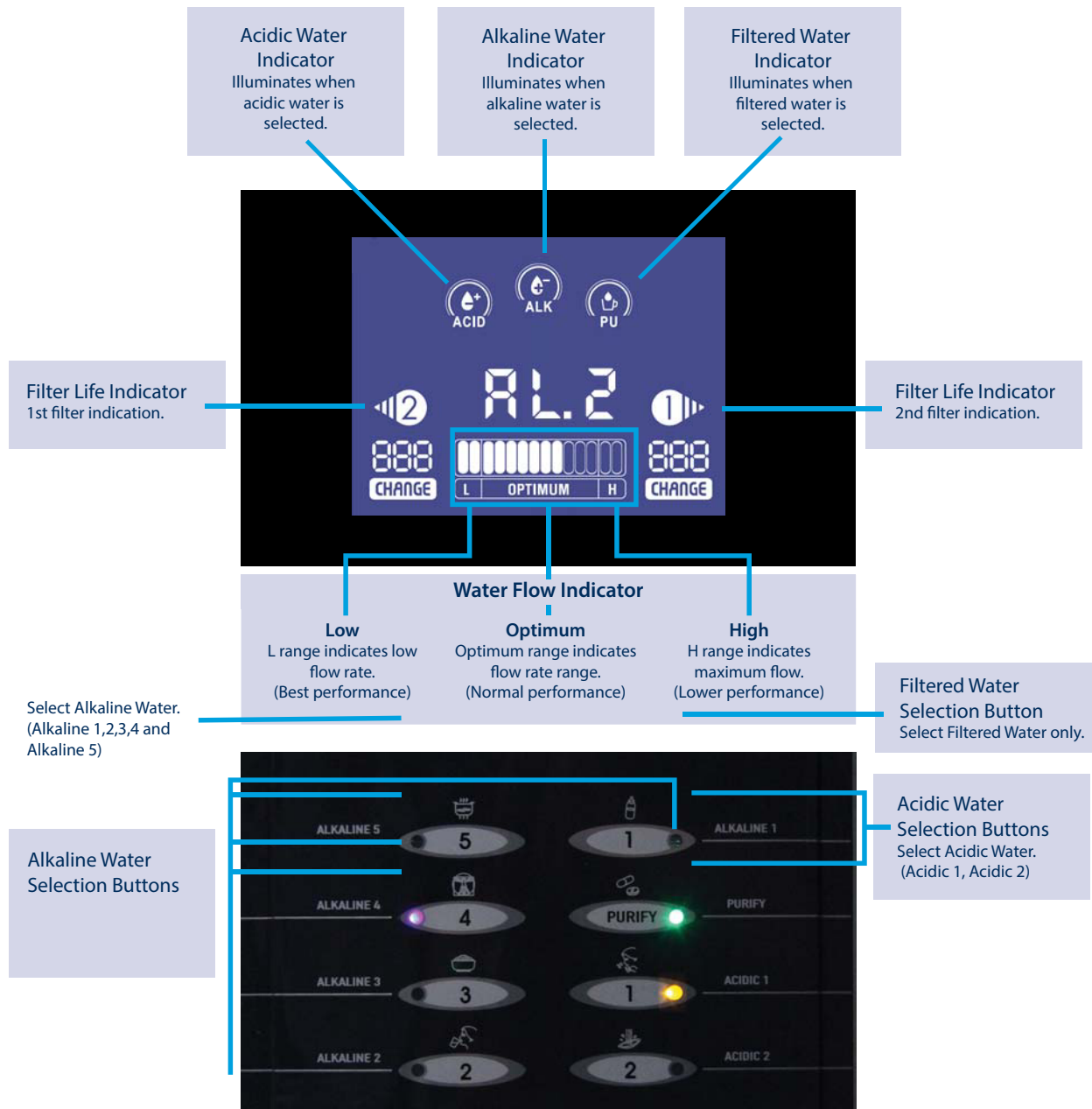

Make Sure you Have all the Accessories

If you have installation questions, please call AlkaViva Customer Service.

Installation Options

Install Method 1: At your sink attached to your faucet with the Diverter,

Install Method 2: At your sink but plumbed directly to your cold water line (no Diverter)

Install Method 3: undersink - completely out of sight with a small dedicated faucet.

It is recommended that Methods 2 and 3 be done by a licensed plumber.

Before installation, please check to ensure you have the accessories pictured below.

Please note that the Diverter and adapters accommodate the vast majority of standard faucets. The optional Angle Stop Adapter fits both 1/2" and 3/8" standard plumbing. If you have a non-standard or a custom faucet, or plumbing, you may need to locate and purchase additional parts. If you need help, please contact AlkaViva Customer Service.



Complete Installation Package

Your Angle Stop Adaptor will look like one of the two styles shown below depending on your Country.



Angle Stop Adapter
(optional part on request)



pH Test Reagent



In-line Sediment Filter
(Arrow indicates direction
of water)

Note: The sediment filter is an optional accessory that will further protect your ionizer and lengthen the life of your filters. It is installed in the 1/4" white tap water inlet hose before it enters your ionizer in any of the three installation methods. It can be opened and cleaned as needed.



Note: The extra wire at the bottom of your ionizer is only to be used in conjunction with the Delphi H₂ Faucet (not included). If you are interested in learning more about the Delphi H₂, contact your dealer or AlkaViva Customer Service.

Installation Method 1: At the Sink, With a Diverter (Easiest)



Tools You May Need:

- Standard pliers or channel locks
- A sharp knife or a good pair of kitchen scissors



1. Attach Diverter to Your Tap - Remove the aerator from tap (pliers may be required) and attach Diverter valve in its place. In case the diverter does not fit your tap, we have included adapters. To prevent leaks, use plumber's Teflon tape when installing the diverter at your faucet.

2. Attach the 1/4" White Hose to the Diverter (Fig. 1) - Measure the appropriate length of white hose to go from the diverter to the bottom of the ionizer, allowing for a reasonable amount of slack, and cut using sharp knife or scissors. Remove the small compression nut on the back of the Diverter (opposite of the lever). Slide the nut over the opposite (free) end of the white 1/4" hose with the threads positioned so it will screw onto the Diverter. Push the hose firmly onto the nipple, then screw the compression nut back on. Ensure the nut is tightened firmly. Do not over tighten.

3. Attach the 1/4" White Tap Water Inlet Hose (Fig. 2) - Attach the white 1/4" hose coming from the diverter to the white port on the bottom of the ionizer labeled TAP WATER INLET. To attach the white hose, simply push it firmly into the opening on white port. Give it a gentle tug to ensure proper connection. If it is properly installed, it will not come out. If you need to remove it, press on the ring at the end of the fitting while pulling out.

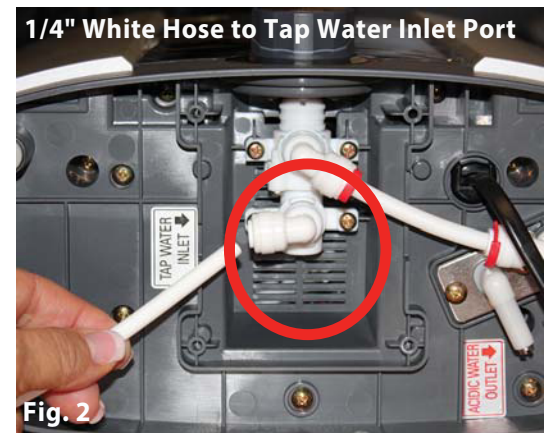

4. Attach the Gray Acidic Water Outlet Hose (Fig. 3) - Attach the gray hose to the white plastic port labeled ACIDIC WATER OUTLET on the bottom of the ionizer. First, slide a squeeze clamp over the end of the hose. Attach the gray hose by simply pushing it firmly over the white plastic port. Soaking it in hot water for 30 seconds will make attaching it very easy. Squeeze the clamp and position it over the white port. Ensure the opposite end runs into the sink.

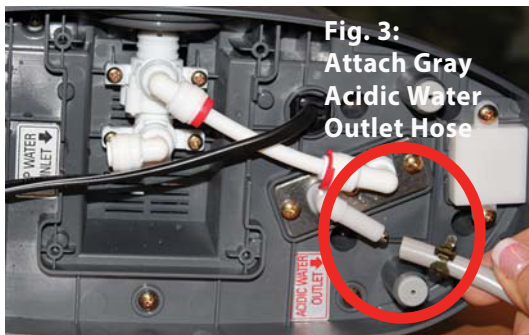

5. Position your Ionizer - Ensure it is on a hard and level surface. See installation precautions.

6. Connect the Power Cord - Use an appropriate grounded outlet.

7. Install Flexible Stainless Steel Spout - Screw the spout clockwise into the threaded silver port on top of the ionizer. Do not over tighten.

8. Save the Box your ionizer came packed in. This will help if your ionizer needs to be transported at a later date.

Installation Method 2: At the Sink, Direct Plumb (More Difficult)



Tools You May Need:

- Wrench
- Pliers
- Drill with 1/4" or 5/16" bit

1. Install Angle Stop Adapter (optional part on request) to Cold Water Supply Line

Locate the cold water line. Shut off the cold water supply. Unscrew the flexible supply line from the Angle Stop. Attach the Angle Stop Adapter. (Fits standard 1/2 and 3/8" plumbing.) Make sure Angle Stop Adapter is in "off" position (blue knob parallel to the length of the body of the Angle Stop Adapter). Leave Angle Stop closed (in water shut off position) (Fig 1). If you have a copper line, you may consider replacing it with a flexible supply line for easier installation.



2. Attach the White 1/4" Tap Water Inlet Hose to the Angle Stop Adapter

(Fig. 1) Attach the white 1/4" hose to the Angle Stop Adapter by simply pushing firmly into the white port. Give a gentle tug to ensure proper connection. It should not come out. You will need a way to route the white hose from the Angle Stop Adapter to your ionizer. Most newer sinks have cutouts that will work for this. If not, drill a 1/4" hole.

3. Attach the White 1/4" Tap Water Inlet Hose to your Ionizer (Fig. 2)

Attach opposite (free end) of the white 1/4" hose to the white TAP WATER INLET port on the bottom of the ionizer. To attach the white hose, simply push it firmly into the TAP WATER INLET port. Give it a gentle tug to ensure proper connection. It should not come out. To remove it, press the ring at the end of the fitting and pull the hose out at the same time.



4. Attach the Gray Acidic Water Outlet Hose (Fig. 3) - Attach the gray hose to the white plastic port labeled ACIDIC WATER OUTLET on the bottom of the ionizer. First, slide a squeeze clamp over the end of the hose. Attach the gray hose by simply pushing it firmly over the white plastic port. Soaking it in hot water for 30 seconds will make attaching it very easy. Squeeze the clamp and position it over the white port. Ensure the opposite end runs into the sink.



5. Position your Ionizer - Ensure it is on a hard and level surface. See installation precautions.

6. Connect the Power Cord - Use an appropriate grounded outlet.

7. Install Flexible Stainless Steel Spout - Screw the spout clockwise into the threaded silver port on top of the ionizer. Do not over tighten.

8. SAVE THE BOX your ionizer came packed in. This will help if your ionizer needs to be transported at a later date.

Installation Method 3: Undersink with Conversion Kit (Most Difficult)

Undersink installations can only be accomplished with an AlkaViva Undersink Conversion kit. Off the shelf parts will not work. Your ionizer will require a very specialized faucet and a variety of other parts. The Conversion Kit comes with everything needed including instructions to complete this type of installation. AlkaViva recommends that a licensed and bonded plumber or contractor perform this type of installation. Please contact AlkaViva Customer Service for details.

Operating Your Ionizer

For Installation Method #1 - at the sink with a Diverter:

1. Open the Flow Control Valve - This control is on the front of the machine and has an ON and OFF position. Try initially setting this half way between ON and OFF

Important : This is one of the most critical features in controlling your ionizer's performance. This control WILL DIRECTLY impact the performance of your ionizer. A slow flow will yield higher performance; a fast flow will yield lower performance.

2. Turn on your Cold Water Faucet- Turn the Diverter lever until the water runs through your ionizer.

3. Notice the Difference in Flow Rates by adjusting the FLOW CONTROL VALVE from a slow trickle to the fastest flow. When you begin making hydrogen-infused ionized water, start with it in the normal, or optimum range for optimal results.



For Installation Method #2 - at the sink direct plumbed

1. Turn on the Water Supply Line at the Angle Stop - Ensure the Angle Stop Adapter is in the open position. (The blue knob parallel to 1/4" Tubing or Hose.)

2. Open the Flow Control Valve - This control is on the front of machine and has an OPEN and CLOSE position. When ionizing water initially try opening the valve half way between OPEN and CLOSE.

Important: This is one of the most critical features in controlling your ionizer's performance. This control WILL DIRECTLY impact the performance of your ionizer. A slow flow will yield higher performance; a fast flow will yield lower performance.

3. Notice the Difference in Flow Rates by adjusting FLOW CONTROL VALVE from a slow trickle to the fastest flow. When you begin making hydrogen-infused ionized water, start with it in the normal, or optimum range for optimal results.



What you will Notice:

- The control panel will illuminate, and water should flow from both hoses.
- The Digital Filter Life Indicator will begin to register numbers and you will hear your ionizer's "voice" announcing the mode of operation. For instance: "Purified water selected".

NOTE: When running water through your ionizer for the first time, the water will initially come out discolored (light to charcoal gray) due to carbon dust in the new filter. This is not harmful and is typical of all carbon filters. To flush your new filters, allow the water to flow for 1-2 minutes in the PURIFIED mode until it runs clear.

Operating Your Ionizer

Selecting Alkaline, Ionized Hydrogen-Infused Water



Water Flow Indicator



When you select Alkaline water, it will flow through the Flexible Stainless Steel Spout at the top of your H₂ Series Ionizer.

1. Open the Flow Control Valve to let the water flow in. Your control panel will illuminate and the word ALKALINE will show on the display. For optimal performance, set the value so the flow is in the normal range on the display.
2. Use the ALK button to select the level. A light on the selected ALK button will illuminate.
3. You will hear voice confirmation: "Alkaline Ionized Water on process."
4. To change alkaline levels, simply press the button of the alkaline level desired, ALK 1-5. ALK 1 is the weakest setting and ALK 5 is the strongest.
5. Your H₂ Series Ionizer will always "remember" the last setting used. If you were using ALK 2, the next time you start your ionizer it will automatically start on ALK 2.

Exception to the above: when ALK 5 (strong alkaline) is selected, your H₂ Series Ionizer will come on at the last ALK 1-4 level used the next time you use it.

Alkaline Level Buttons

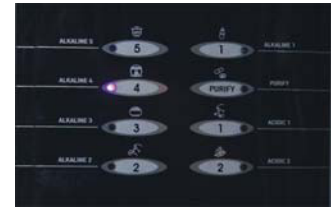

What you will see in the Display



This value will change, depending on the ALK setting you have chosen.

When the tap water flows through your H₂ Series Ionizer, the Water Flow Indicator illuminates: **L** when the water pressure/flow rate is low and **H** when it is high, **OPTIMUM** when it is normal. Your H₂ Series Ionizer will produce optimal performance for drinking water (the perfect balance in pH, -ORP, H₂ and taste) when it is in the normal range.

Selecting Acidic Ionized Water

Acidic Level Buttons



What You Will See In the Display



This value will change depending on the ACID setting you have chosen.

When you select Acidic water, it will flow through the Flexible Stainless Spout at the top of your H₂ Series Ionizer.

1. Open the Flow Control Valve to let the water flow in. Your Control Panel will illuminate.
2. Use the ACID button to select the level. Your control panel will illuminate and the word ACID will show on the display. For optimal performance, set the value so the flow is in the normal range on the display.
3. You will hear voice confirmation: "Acidic Ionized Water on process." You will also hear a melody to alert you that acidic water is running.
4. To change acid levels, simply depress the button of the acidic level desired, ACID 1 or 2. ACID 1 is the weakest setting and ACID 2 is the strongest.
5. Your H₂ Series Ionizer will always "remember" the last alkaline setting used. If you were using ACID 1, the next time you start your ionizer it will revert to the last ALK 1-4 level you used.
6. When the tap water flows through your H₂ Series Ionizer, the Water Flow Indicator illuminates: **L** when the water pressure is low and **H** when it is high, **OPTIMUM** when it is normal.

NOTE:

- Acidic ionized water is not intended for regular drinking water. Acidic ionized water has many great uses. Learn more about this on page 15, "Uses for Acidic Water".
- The DARC cleaning system will help keep your electrodes clean. Running acidic water through your ionizer will keep the rest of the components of the machine clean. **If you live in a hard water area this should be done daily for 1-2 minutes.**

Selecting Purified Water

Purified Water Buttons

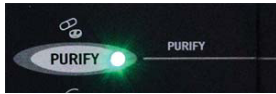

What You Will See In the Display



PU will always appear.

Purified water is only filtered, not ionized. When selected, it will flow through the Flexible Stainless Steel Spout at the top of your H₂ Series Ionizer.

1. Open the Flow Control Valve to start the water flow. NOTE: Your control panel will illuminate.
2. Use the PURIFIED button to select filtered water. On the control panel the word PURIFY will illuminate and the letters "PU" will illuminate on the display panel.
3. You will hear voice confirmation: "Crystal clear water in production."
4. Your H₂ Series Ionizer will always "remember" the last alkaline setting used. If you were using PURIFIED, the next time you start your ionizer it will revert to the last ALK 1-4 level you used.

When the tap water flows through your H₂ Series Ionizer the Water Flow Indicator illuminates: **L** when the water pressure is low and **H** when it is high, **OPTIMUM** when it is normal.

Manually Adjusting the Power

While AutoAdjust automatically provides very fine real-time adjustments to the electrical pulse, you can also manually adjust the power to best suit your unique water quality and desired performance requirements. By manually changing the power-steps for each Alkaline and Acidic level, you can change the main power settings, making bigger and more impactful changes in performance. Here's how:

Step 1. Start water flow through your ionizer by turning on the Flow Control valve and/or Diverter.

Step 2. For this example, we will use ALK 5 level. You may manually set this for each ALK or ACID level. Select the ALK or ACID level you'd like to adjust – just as you would for changing levels under normal operation.

Step 3. Press and hold the ALK 5 button until Display changes to look like figure 1.

The first digit (5) means "ALK Level 5" and second digit (2) means electric power value 2. There are four electric power values available - Power Level 1 is the lowest and Power Level 4 the highest. If you want to raise or lower the Power Value, press same button (ALK Level 5). The second digit will change to reflect the power level.



Fig. 1

Step 4. Press "purify" to save the setting. The next time you use the ionizer, it will "remember" the last manually selected Power Level. You must set each ALK and ACID level.

Step 5. For other levels, please repeat the steps above.

Ionizer Performance Factors

There are three primary factors that control the performance of your ionizer:

- 1) The quality of your source water and its mineral content. We cannot control this factor.
- 2) The voltage being applied to the water. You control this by selecting the ALK level or ACID level on the control panel. The higher the setting, the more voltage or power applied to the water.
- 3) The flow rate of water through your ionizer. You control this with the Flow Control knob on the control panel. This determines how long the water is being processed. With a fast flow your ionizer will produce lower pH, with a slow flow it will produce higher pH.

Water quality and mineral content vary greatly in different localities. Use the pH Test Kit and be sure to test your source water. Generally in "hard water" areas where mineral content is higher, your ionizer will easily reach high levels of pH even with a faster flow. In "soft water" areas where mineral content is lower, your ionizer may only reach the higher levels of pH with a slower flow. If your source water tests at a very low pH, you may want to "boost" performance by adding a calcium cartridge into the calcium port at the top of the ionizer filter (see page 17).

How to Measure pH

1. Fill a shot glass or other small, clean glass container with about 1 inch of alkaline, acidic or purified water.
2. Place 3 drops of the pH reagent into the container and gently shake or stir. If the reagent and water are not mixed well, the correct result may not be achieved. Too many or too few drops will affect results.
3. The pH value is determined by matching the color to the pH color chart provided.
4. Keep the pH reagent in a dark and cool place. DO NOT expose to sunlight or heat.
5. Be sure to rinse out the container thoroughly prior to each use or the pH level may be incorrect.
6. Do not drink the water that has been tested with the pH testing solution.

Using Alkaline, Ionized Water



Caution!

Don't Develop a 'Drinking' Problem!

If you've never used hydrogen-infused ionized water, do not use an Alkaline Setting higher than 1 to begin with. Let your body adjust slowly and naturally for 2-3 days. After this initial adjustment period, gradually increase the alkalinity of the water by increasing the setting you use.

Do not take medications with ionized water. Take medications only with purified, filtered water.

Consult with a physician before drinking ionized water if you are currently under medical treatment, have a chronic disease, or have achlorhydria.

Consult a physician before using acidic water externally if you have sensitive skin or allergies.

Do not drink acidic water.

Only use potable drinking water in your ionizer. Poor water quality may have negative effects on your health and your ionizer! Most municipal water sources will be fine in your ionizer. Well water and water from smaller systems should be checked and may require pre-filtering.

Do not drink the following types of water:

- Acidic water.
- Water tested with the pH reagent, or pH reagent by itself.

Additional Cautions

- Do not use the water in an aquarium.
- Ionized water loses its effectiveness if stored for more than a day or two.

Suggested Alkaline Water Levels

5 – Cooking vegetables

4 – Making coffee / tea

3 – Cooking rice, grains, beans and pasta

2 – Drinking

1 – Drinking – start drinking at level 1 for 2-3 days. After this initial adjustment period, gradually increase the alkalinity of the water by increasing the setting you use.

Helpful Hint: Ionized hydrogen-infused water is always best fresh out of the ionizer and ideal if consumed on a day-to-day basis. Carry it with you in glass, ceramic or high quality BPA-free plastic bottles. Always keep your stored water cool and away from direct sunlight to preserve optimal water quality.

Purified Water Setting

Use this setting when taking medication.

Suggested Acidic Water Levels

1 – Washing face, hair, and mouth rinse

2 – Cleaning counters, cutting boards, etc.

Other Uses for Hydrogen-Infused Alkaline Water

Cooking rice

Try cooking rice after soaking the rice in the alkaline water for 30 - 60 minutes in advance. When cooking rice with the alkaline water, the rice will be glossy, tasty, and it will store better for a longer period of time.



Coffee, black tea and herbal tea

Help remove the bitter taste of coffee and the puckery taste of black tea as well as enriching the faint taste and fragrance unique to black tea.

Heavy drinking and hangover

If you drink a 12-16 oz glass before going to bed or on an empty stomach in the morning you will minimize the effect of a hangover.

Various dishes

When cooking bamboo shoots, tree shoots, taro and seaweed with the alkaline water, the bitter taste and the sour taste will be gone while the natural taste will be enriched. When using it as the water for steaming fish, the fishy smell will be eliminated and it will make the fish taste better.



Liquors and cocktails

When used as the water for mixing, liquor will taste softer and milder. When making a cocktail, use ice made from alkaline water.

Plants

If seeds are soaked in the alkaline water before being planted, the germination rate will be enhanced. In case of stem cutting or grafting, they will take better.

Vegetables and fruits

Wash vegetables or fruits in alkaline water and they can be kept fresh for a longer period of time.

Vegetables with unpleasant odors

When cooked after being soaked in the alkaline water for about 20-30 minutes, odor will be reduced, making vegetables softer and tastier.



Uses for Acidic Water

Skin Care

Acidic water can be a beauty solution for your skin. It acts as an astringent and helps make the skin soft and elastic. (Skin is mildly acidic.)

Hair Care

Use acidic water as a hair rinse after shampooing to neutralize the alkalinity of the shampoo, and help retain the hair's natural gloss.

Shaving

Use acidic water after shaving; it can replace skin toner or after shave.

Floral arrangement

Use acidic water for cut flowers. It will keep the flowers fresh for a longer period of time.

Boiling eggs

When the acidic ionized water is used for boiling eggs, the shell is less likely to crack while cooking and the eggs will peel easily.

Water for parboiling noodles

When the acidic ionized water is used for parboiling noodles, it will make them chewy and tastier.

Washing or processing deep colored fruits and vegetables

Washing peaches, grapes, strawberries, red cabbages, beans and asparagus etc. with acidic water will retain their natural colors and they will stay bright and vibrant.

When preparing fried dishes

Use acidic ionized water to prepare batter for fried dishes to make the foods crispy and tastier.

General cleaning

When the acidic ionized water is used for cleaning floors, dirt and grime can be easily removed and it dries quickly.

Cleaning glass

When glass, mirrors and glasses are washed with acidic ionized water, dirt and grime is easily removed and glass is shiny without streaks.

Encrusted pots and pans

Soak pots and pans in the acidic ionized water overnight to remove encrusted or burnt food.

Cleaning the cutting board or counters

Use acidic ionized water to naturally clean and sanitize your cutting board and counters.

Cleaning dishes and silverware

Use acidic water for cleaning dishes and silverware. It will not leave spots.



Replacing the H₂ Series Smart Filter

Replace your Smart Filter when the Filter Life Indicator on the Control Panel lights up and displays 999 (for an Ultra Water Filter and Pre-Filter). The Filter Indicator indicates which filter needs to be changed (Filter 1 or Filter 2).

IMPORTANT NOTE: The Smart Filter will run for approximately 200 gallons beyond the end of the filter life. After that, the ionization will be disabled unless new Smart Filters are installed. Make sure you order your replacement filters in advance!

Considering that filter life span can differ based on water quality in individual areas, we recommend replacing the filter before the end of the life span is reached if the water smells or the water flow rate decreases.

Possible situations where filter life can be shortened:

- If there is sediment or impurities in the water
- If you have very low water pressure
- If you have untreated water, such as a private well

Open Both Filter Covers (Fig. 1)



Fig. 1

Press the white button to unlock the cover. It is in the middle of the bottom of the cover.

Remove the Cover (Fig. 2)

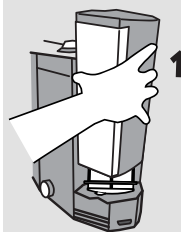

Fig. 2

With the cover unlocked, lift the cover straight up.

Remove the Old Filters

Unplug the wire harness at the top of the filter. Twist the expired filter counterclockwise and lift out.



Remove the protective sticker on the base of the new filters.

Install New Filters (Fig. 3)

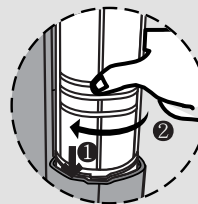

Fig. 3

Be sure each filter is in its proper place: Pre-Filter / Fluoride Filter goes in the right side, Main Filter goes in the left side. Insert the opening at the base of the filter onto the raised filter base. Twist clockwise until locked into place.

Check for leaks. Leaks occur when filter is not seated properly. In this case, take filter out and reinstall.

Install New Filters (Fig. 4)

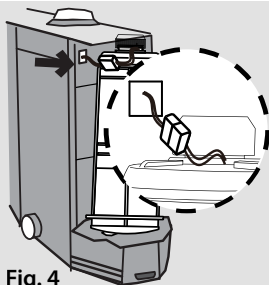

Fig. 4

Reconnect the wire harness to the new filters.

This will reset the Filter Life Indicator to 0.

Install New Filters (Fig. 5)



Fig. 5

Close the covers by lining up the vertical edges and slide down until you feel / hear the cover lock.

Always flush your new filters using the Purified Setting for 1 - 2 minutes or until the water runs clear.

Adding Optional Calcium Inserts

Use calcium inserts if you have soft water.

1. Ensure the water flow is off.
2. The inserts go into a port on the top of your filter. To access the filter, follow the instructions on Page 14, 'Replacing the H₂ Series Smart Filter'.
3. Once you have the filter removed, unscrew the cap on the top of the filter body. If you have previously used an insert, dispose of the old insert. (Fig 1)
4. The new insert will have a soft silicone protective cap. Remove the cap.
5. Place the new insert into the port on the top of the filter, with the open end up. **DO NOT EMPTY THE CONTENTS INTO THE PORT.** (Fig. 2)
6. Replace the cap on the port of the filter. Tighten firmly to prevent leaking.
7. Replace the filter following the instructions on Page 14, 'Replacing the H₂ Series Smart Filter'.



Fig. 1



Fig. 2

Installing the Optional In-line Sediment Filter

Consider using the In-line Sediment Filter if the aerator on your faucet needs regular cleaning, meaning there is sediment in your water. An In-line Sediment Filter is included with all ionizer models. Install the In-line Sediment Filter on 1/4" White Tubing somewhere between your source water and the tap water inlet (arrow located on filter indicates direction of water). Cut tubing according to your installation needs. See photos below.



1. In-line Sediment Filter attaches to 1/4" White Tubing as pictured.

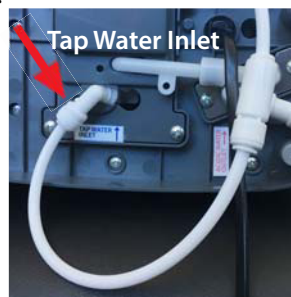

2. Install shortest part of tubing at the Tap Water Inlet - make sure the arrow on the Sediment Filter points towards the TAP WATER INLET.

Operating the Quick Connect Fitting

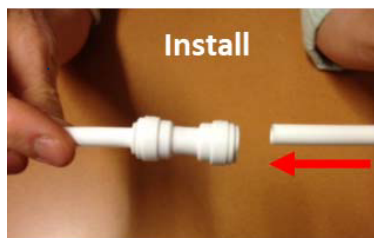

Install

Install: Insert tubing into Quick Connect Fitting and PUSH IN firmly until it can't go further. Give a gentle tug to ensure proper connection.

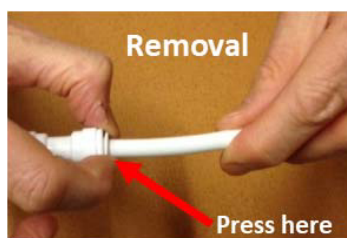

Removal

Press here

Troubleshooting

Condition	Possible Cause(s)	Resolution
The Control Panel does not come on	The power plug is not properly inserted, or it is inserted into a faulty outlet	Properly insert power plug into a correctly functioning power outlet.
The Control Panel / Display Indicators do not come on after starting water flow through the ionizer	The fuse is blown The fuse is not inserted properly	Replace the fuse. A spare fuse is included in your reagent kit (3A / 110 V fuse).
	Faulty Flow Sensor Faulty Circuit Board	Immediately unplug the unit and contact AlkaViva to arrange service
pH test shows little or no change in color	Most likely, your reagent is out of date and has expired. This is usually caused by age, exposure to light, heat, or air	Replace reagent
Power supply is suddenly cut off while operating the unit	Electrical problems including safety switches and fuses	Check your power outlet or replace fuse
	High level of TDS or salts in the water, extended time of operation, sudden change in electrical current. In these cases, your machine will shut down automatically to protect the electrodes and circuitry	The AutoAdjust feature has built-in protection from extended use or high TDS. Wait 30 - 60 minutes and try to operate your ionizer again
Low or slow flow of alkaline water from the ionizer	Clogged filter. Premature clogging may be caused by a sudden drop in water quality and an influx of sediment or other contaminants, which stress the filter	Replace your filter Clean pre-filter
	Low pressure in your household plumbing	Ensure water supply valves are fully open. Increase water flow from supply
	The input tubing is bent, kinked, or otherwise restricted	Straighten the bent, kinked, or restricted tubing
No acid water flow from the acidic output port	Acidic output hose is bent, kinked or otherwise obstructed	Straighten the bent, kinked, kinked or otherwise obstructed hose. Increase water flow from supply
Water leaking from the filter cartridge housing	Filter not installed correctly in the filter housing	Remove your filter and reinstall it properly following the filter replacement instructions. Increase water flow from supply
Water appears milkish - white snow like particles in the bottom of your glass	You have high levels of hardness (calcium, primarily) in your water. The white is extracted CaCO ₃ (calcium carbonate)	This is calcium! It is harmless to ingest, and actually good for you. Remember, the ionizer separates and condenses the alkaline minerals and this is what you are seeing You can lower the setting (1-2) and reduce this effect. Typically, this only occurs in hard water areas. See Page 3

Abnormal Condition	Possible Cause(s)	Resolution
At first, no smell, but then smell from the alkaline water about one hour later	Expired filter	Replace filter(s)
	Your water bottle or receptacle is dirty and needs cleaning. Contamination mixes with alkaline water when filling your bottle	Clean your water bottle or receptacle
Strange smell from alkaline water	Expired filter from ordinary use, or clogging from change in water quality	Replace filter(s)
	Sudden change in water quality with elevated level of some disinfectants and naturally occurring elements in the water (not Chlorine). These elevated levels are observed in some areas during the summer months. These levels fall within safe drinking water standards, yet will cause a reaction with ionized water, causing a unique smell	Select a lower pH level. If the smell is still present, you may consider replacing your filter

DO NOT attempt to repair your ionizer yourself. Doing so could void your valuable warranty.



V. 7.30.18