

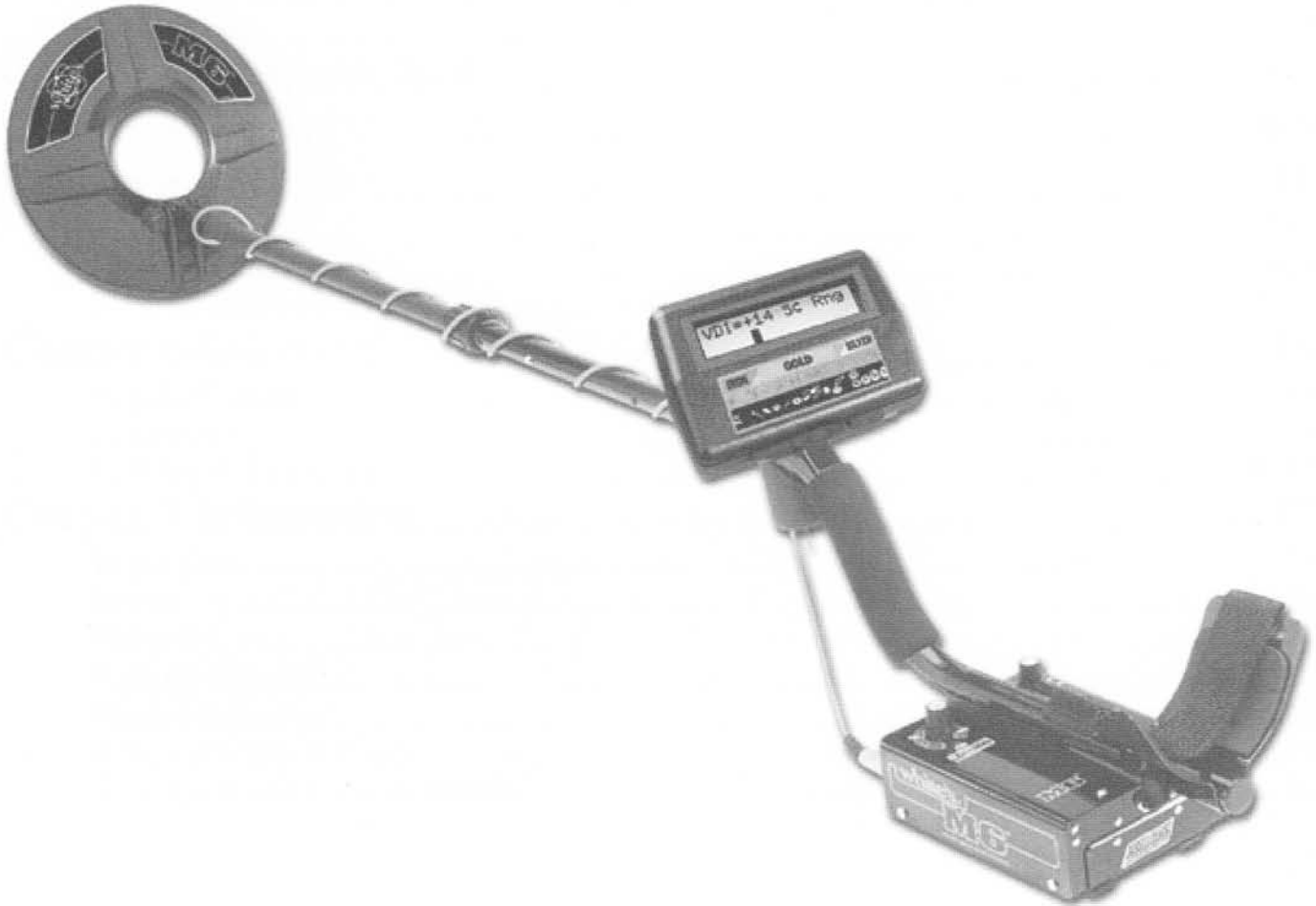

OWNER'S GUIDE



M6

White's Electronics, Inc. -
Manufacturers of the World's Finest Metal Detectors

To see complete details or to purchase the White's Matrix M6 Metal Detector, visit:
<http://www.metaldetector.com/whites-matrix-m6-metal-detector>

To see complete details or to purchase the White's Matrix M6 Metal Detector, visit:
<http://www.metaldetector.com/whites-matrix-m6-metal-detector>

M6 Table of Contents

Chapter 1 Assembly	2
Assembly Instructions	3
Chapter 2 Batteries	4
Standard Battery Holder	4
Using the Standard Battery Holder	4
Rechargeable Battery (Opt.)	5
Battery Check	5
Chapter 3 M6 Quick Start	6-7
Chapter 4 Display ..	8-9
Chapter 5 Controls	11
AUTO TRAC®	12-13
SENS (Sensitivity)	14-15
DISC (Discrimination)	16-17
Chapter 6 Searching	18
Pinpoint Technique	18
Headphones	19
Field Use & Tuning Tips	20-21
Chapter 7 Information	22
Proper Care	22
Service	23
Warranty	24
Warranty Transfer	25
Owner Information	26
White's (UK)Ltd Warranty	27
White's (UK)Ltd Warranty Transfer	28

Assembly

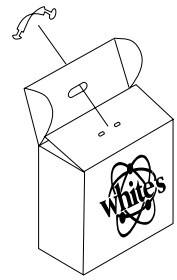

Twist and insert each end of handle (provided) through top of shipping carton into second flap. (CARRY CARTON)

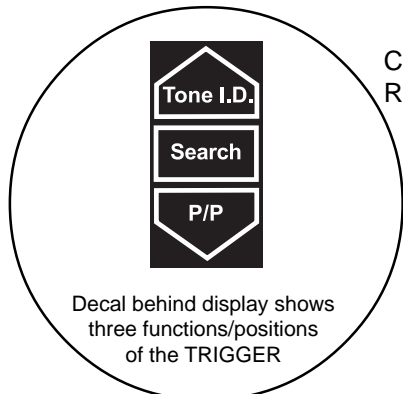
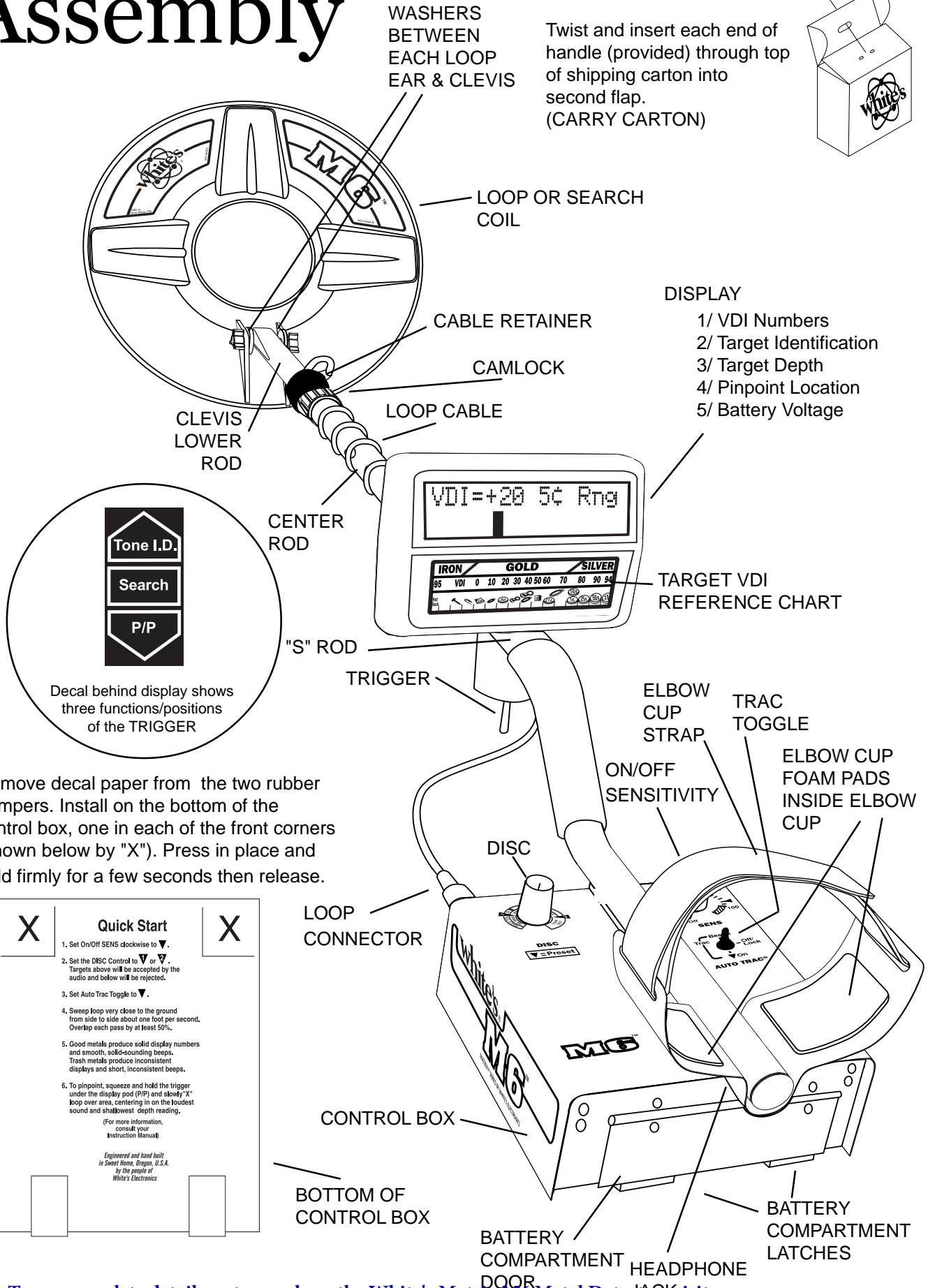

Decal behind display shows three functions/positions of the TRIGGER

Remove decal paper from the two rubber bumpers. Install on the bottom of the control box, one in each of the front corners (shown below by "X"). Press in place and hold firmly for a few seconds then release.

X	<p>Quick Start</p> <ol style="list-style-type: none"> 1. Set On/Off SENS clockwise to V. 2. Set the DISC Control to V or V. Targets above will be accepted by the audio and below will be rejected. 3. Set Auto Trac Toggle to V. 4. Sweep loop very close to the ground from side to side about one foot per second. Overlap each pass by at least 50%. 5. Good metals produce solid display numbers and smooth, solid-sounding beeps. Trash metals produce inconsistent displays and short, inconsistent beeps. 6. To pinpoint, squeeze and hold the trigger under the display pod (P/P) and slowly "X" loop over area, centering in on the loudest sound and shallowest depth reading. <small>(For more information, consult your instruction Manual)</small> <p><small>Engineered and hand built in Sweet Home, Oregon, U.S.A. by the people of White's Electronics</small></p>	X
----------	--	----------

Assembly Instructions

1. Remove all parts from shipping carton and check the assembly page to make sure the kit is complete.
2. There are rubber washers between clevis/lower rod and loop ears. **Use only the provided washers, fiber bolt, and thumbnut to secure loop/search coil to clevis/lower rod.**
3. Unlock rod camlocks and insert clevis/lower rod into center rod. Center rod into curved "S" rod so that stainless steel spring slip buttons line up and lock into one of the adjustment holes. Turn camlock to secure.
4. Unravel loop cable and wind the cable around the clevis and rod assembly, first revolution over the top of the rod. Wind cable all the way to the top of the curved "S" rod, about five revolutions. Use the black cable retainers, one near the loop, and one behind the display, to hold the loop cable in place. Plug loop connector into control box and screw finger tight to secure.
5. Unlock control box rod camlock and insert curved "S" rod so that stainless steel spring clip buttons line up and lock into the rod on top of the control box. The "S" rod is designed to curve up toward the display. However, those who prefer to sweep the loop close to their feet may desire to assemble the "S" rod to curve down toward the ground. Turn camlock to secure. Plug loop connector into control box, screw lock ring to secure.
6. Grip the instrument by the handle, with your arm in the elbow cup with strap secure, and sweep the loop/search coil over the floor. If the instrument fit feels uncomfortable, adjust the elbow cup by removing and repositioning the bolt/thumbnut and installing in one of the optional positions. If necessary, readjust clevis/lower rod length with the spring clip buttons so that the search coil can be held near the floor and remain standing comfortably.
7. Remove the protective paper from the two black elbow cup foam pads. Carefully align pads on the inside of the elbow cup, one on each side of the center rod, and press firmly into place.
8. Adjust the elbow cup strap so that it is loose enough for you to slide your arm in and out without loosening each time you want to set the detector down. The elbow cup strap provides extra leverage and control, however, some prefer not to use it.
9. Install battery as described in the next section, **lid decal facing down**, with plastic tab and steel contacts facing toward inside of battery compartment.
10. It should be noted at this point that the detector may not work as expected indoors due to the high degree of metals used in modern construction. It is best to tune and practice outdoors to ensure stable, predictable results. Additionally, freshly-buried targets will not produce the normal depth and discrimination results of targets that have been naturally lost and settled in the ground. It may take a number of years for freshly-buried targets to respond at true depths and discriminate accurately. The best way to determine true detection depth is to use real search conditions.

Batteries

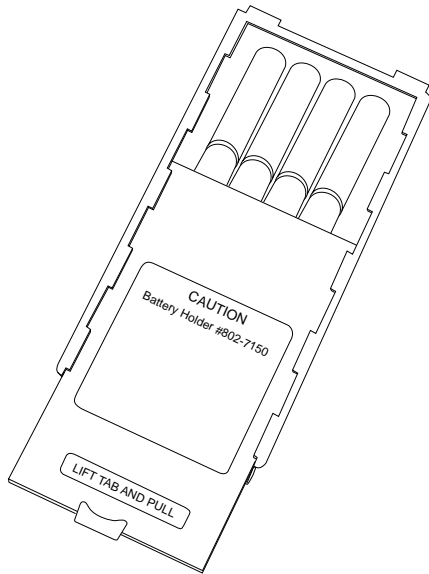

Standard Battery Holder

1. The standard battery holder holds eight “AA” cell batteries equalling 12 volts total. Alkalines are recommended for use with this model. During normal searching conditions you can expect about 40 hours of hunting time from a quality set of eight alkaline batteries.

2. Non-alkaline batteries can be used in this holder. When non-alkalines or rechargeable “AA” cells are used, detecting time (before replacement/recharge) may be reduced to about 30-35 hours.

3. The battery voltage appears automatically on the display when the SENS knob is used to turn the M6 “ON”. Once the batteries become weak (8 volts) “Lo Bat” will automatically appear on the display during searching. At that point the batteries should be replaced. Alkalines provide some reserve time after “Lo Bat” appears, rechargeables do not.

4. The battery compartment opens by gently pulling down on the front of each of the two latches (on the bottom of the control box) releasing the catch and hinging open the door.

Using the Standard Battery Holder

1. Slide open the battery holder lid (decal side of battery holder) by applying gentle upward pressure on the tab of the door so that it unlocks. Slide the door away from the battery box exposing the cell positions.

2. Remove any old cells from the holder. Note the (+) and (-) positions of each cell and the (+) and (-) for each position marked inside the cell tray. Install new “AA” cells **noting carefully the correct (+) and (-) positions.**

If the cells are installed incorrectly, the detector may require service by an Authorized Service Center.

3. Slide the door closed so that it snaps securely.

4. Insert the battery holder into the detector so that the decal is facing down, with the battery holder door tab and metal contact points facing toward the inside of the battery compartment.

Close the battery compartment door and secure the two latches on the bottom of the case. Hook the front of each latch first, then press down on the rear.

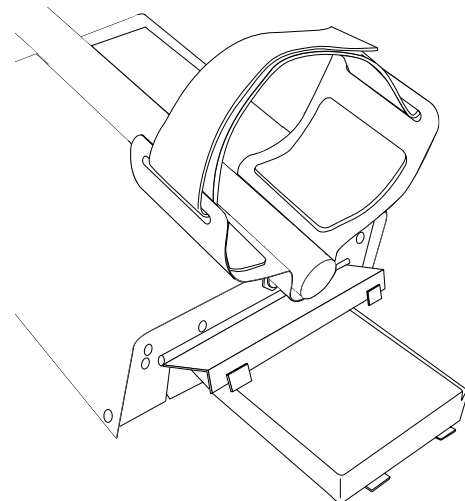

Rechargeable Battery (Optional)

A rechargeable battery system is not standard equipment with your M6, however, high quality systems are available.

White's rechargeable battery #802-5211, and charger #509-0022 are recommended and offer quick charge and overnight charge options.

Rechargeable batteries deliver fairly constant voltage until they're nearly dead. If you use them until they are dead, they will deteriorate more quickly than if you only use them until their voltage starts to drop significantly. Rechargeables should be taken out of the detector and recharged as soon as you notice "Lo Bat" on the display.

Rechargeable batteries will not provide the same amount of continuous use as a new set of Alkaline batteries.

Non-rechargeable batteries will start to drop in voltage as soon as they are put into use and then steadily diminish in voltage until they die. The Nicad rechargeable battery pack, however, will diminish very slowly (plateau) somewhat steadily, then drop quickly.

Headphone use prolongs all battery life.

Battery life will vary a great deal with temperature, number of target signals, battery type, brand, and shelf life.

Alkaline Batteries may be used well into the "Lo Bat" indication. Rechargeables can not.

Battery Packs are available (#802-7150). It is a good idea to have a spare set when far away from a new battery.

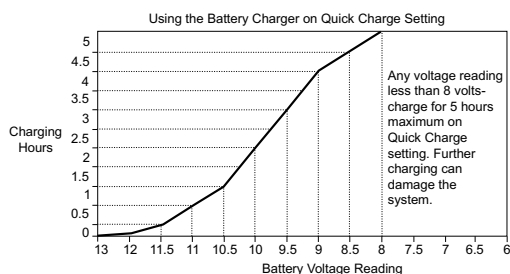
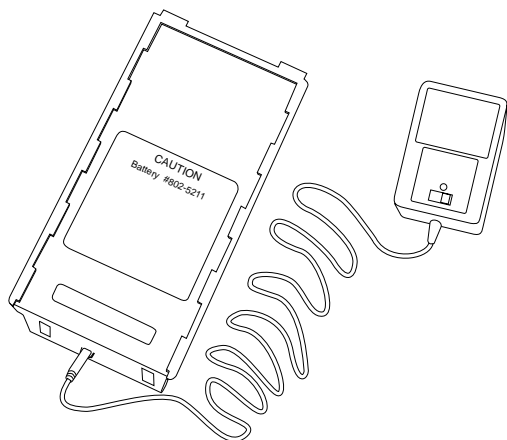

M6 Quick Start

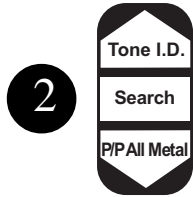
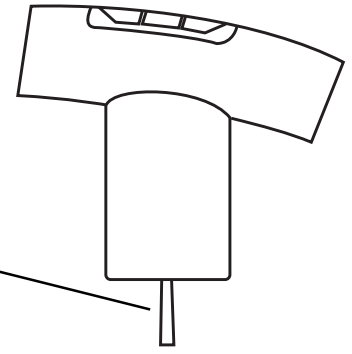

Trigger Switch has three positions;

1. Forward (Tone I.D.).
2. Center (Search).
3. Squeezed and Held (Pinpoint/All Metal).

2

SENS

Turns the M6 ON/OFF and adjusts the signal strength of targets, ground and electrical interference.

4

DISC

establishes the level of trash metal rejection (Discrimination).

3

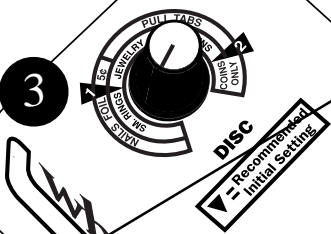

1

TRAC Toggle

The Beach and "▼ On" positions enable "Auto Trac®" to adjust automatically to beach and ground conditions. The center Off/Lock position locks the tracking system and does not track the ground.

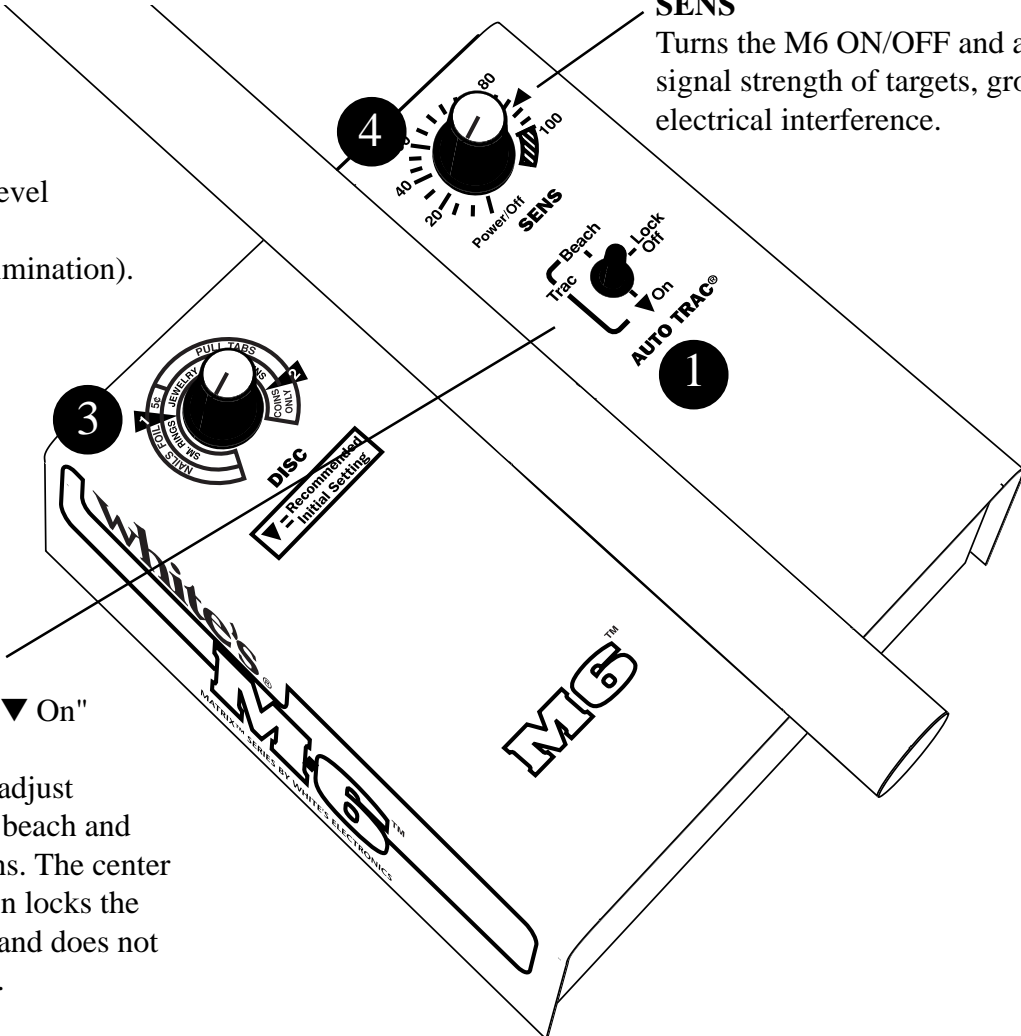

Quick Start Instructions

With the M6 properly assembled and the batteries installed, follow the instructions below to start finding treasures!

- 1 Set the **Auto Trac® Toggle** to the "On" position. "▼"
- 2 Set the **Trigger Switch** (under the hand grip) to the center (**Search**) position.
- 3 Set **DISC** to "▼".
- 4 Turn the **SENS** control clockwise until the power clicks "ON". Rotate the **SENS** control clockwise to "▼".
- 5 Lower the search coil to the ground, then "pump" the coil up and down 2-4" a couple of times and **AutoTrac®** will automatically balance or track out the ground mineralization.
- 6 Start **swinging the search coil** in wide sweeps that overlap each other, as near to the ground surface as possible, about one second per foot.
- 7 If you experience **false signals or constant beeping or popping** and you are not near common sources of electrical interference, set **TRAC** to **LOCK** and/or reduce **SENS** (counterclockwise) slightly and try again.

* SPECIAL NOTICE

If you attempt to demonstrate or test the M6 by waving targets in the air in front of the search coil, the Auto Trac® toggle must be in the Lock position.

When the M6 Auto Trac® toggle is in the "On" or "Beach" positions with no ground present, it will think that the target *IS* ground and will attempt to track it out.

You may, however, demonstrate the fast ground balancing feature of Trac "On" or "Beach" by waving or pumping a mineralized rock in the air in front of the search coil.

5

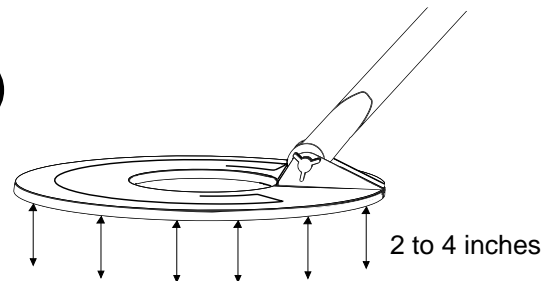

6

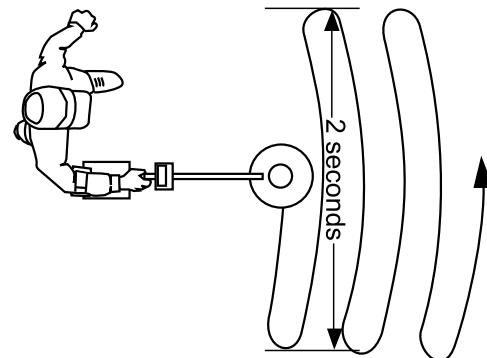

M6 Display

The M6 display and reference label below the display provide a wealth of information about the metal target. The display information works best after the solid repeatable audio "beep".

The display will momentarily show a software version and battery voltage immediately after the SENS knob is turned "on". The M6 operates on a twelve volt battery system, new quality batteries will indicate 12 + volts. After 35 to 40 hours of operation, "Lo Bat" will start appearing on the display at 8 volts and below. If using rechargeable batteries 8 volts is the end of their performance. If you are using quality alkaline batteries you do have a small reserve after 8 volts. Quality alkaline batteries will provide extended normal performance well after the "Lo Bat" warning.

The M6 provides 5 different significant indications on the display.

1. VDI = number - The VDI (Visual Discrimination Indication) is a reference number dictated mostly by the metal targets exact alloy, size, and shape. The reference label below the display provides a comparison of known targets and their common VDI numbers. Different metal targets may share the same VDI numbers based on their electrical characteristics. VDI numbers from -95 to +94 are available and cover the entire range of alloys and sizes.

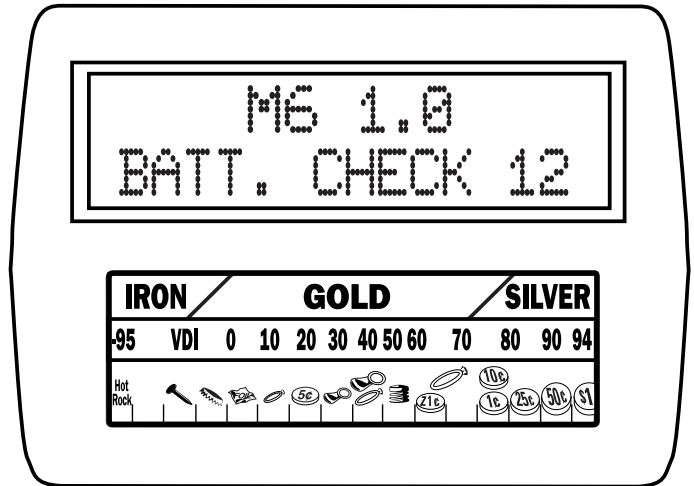

VDI number on display

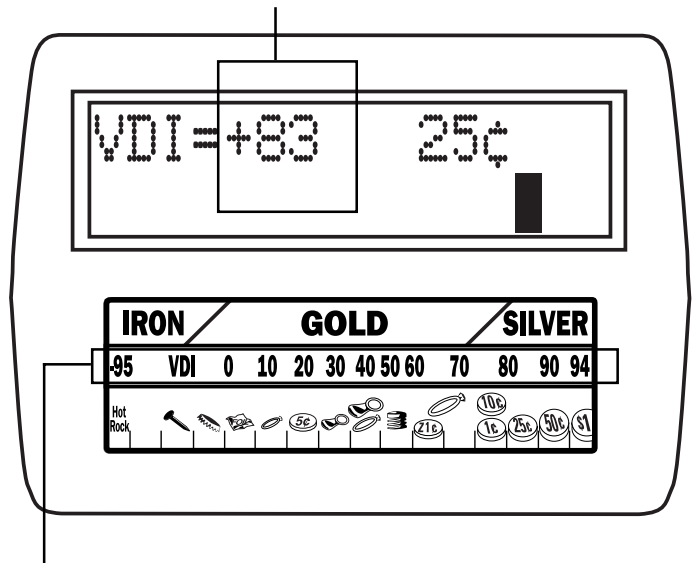

VDI number range on reference label

The M6 (hand grip toggle forward position) has seven distinct tone ranges that correspond directly to the types of targets indicated on the display. The lower the tone, the lower the VDI number.

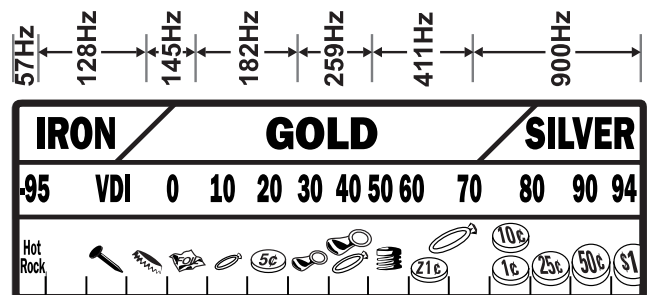

Half block indicates target I.D. is not certain.

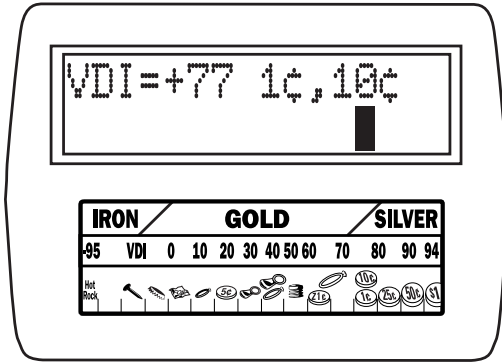
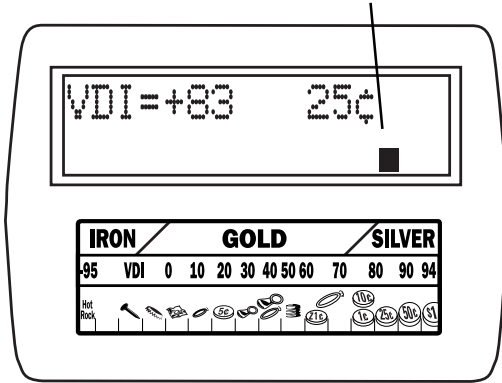

Note: In this case, the 1¢ is the probable ID.

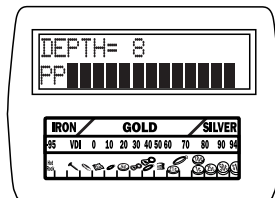
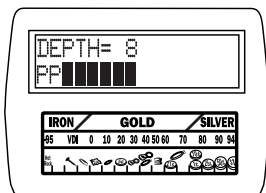
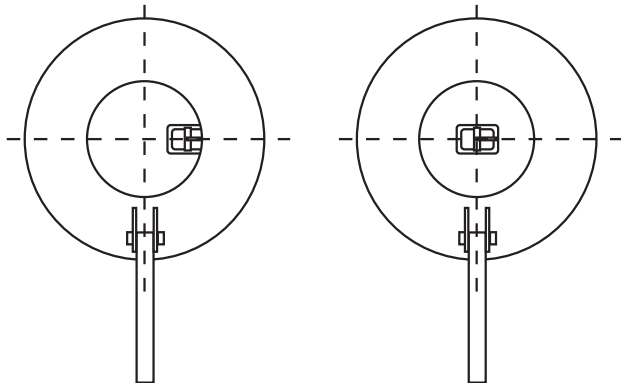
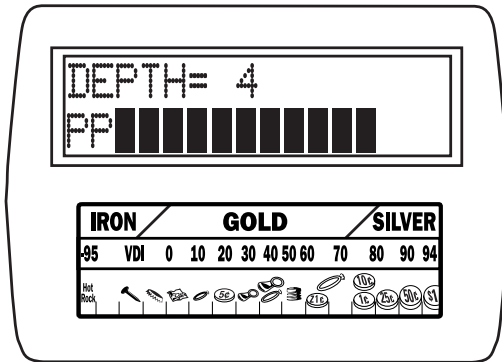

Chapter 4 M6 Display

2. Blocks - A series of 16 blocks appear along the bottom portion of the display and line up with the indications on the reference label below the display. It is important to note these blocks are from a separate source than the VDI number and separate sound provides a second opinion. A full block indicates the M6 has complete information for target identification. A half block indicates the M6 has partial information. A quarter block indicates the M6 has only a small amount of target information.

3. Labels - The most common metal target (or targets in some cases) within a particular Block is listed on the display and referenced on the label below the display. If two targets are listed, the first to be listed is the most common, the second is less common than the first.

4. Depth Indication - Trigger (on hand grip) squeezed and held, the display indicates the depth of coin sized metals. Starting at 12 inches and indicating in descending order (as the target gets closer to the bottom of the search coil) the indicator provides an aid in better locating the target in the ground (how deep you will need to dig) and whether the metal target is likely worth digging. Only the heavier more valued targets get deeper into undisturbed ground. Foil will not sink deeply into undisturbed ground. Targets that indicate depth readings from 3-5 inches are not as predictable.

5. PP Blocks - Trigger (on the hand grip) squeezed and held, the PP blocks aid in pinpointing the exact center of the metal target. When the search coil is directly over the center of the metal target (longest possible length PP Blocks) the depth reading is giving you the most accurate depth indication. With some experience the relative size and shape of the metal target can be recognized during pinpointing.

NOTE: Please refer to page 18 for the proper "X"ing technique to pinpoint the exact center of the target. To see complete details or to purchase the White's Matrix M6 Metal Detector, visit: <http://www.metaldetector.com/whites-matrix-m6-metal-detector>

Controls

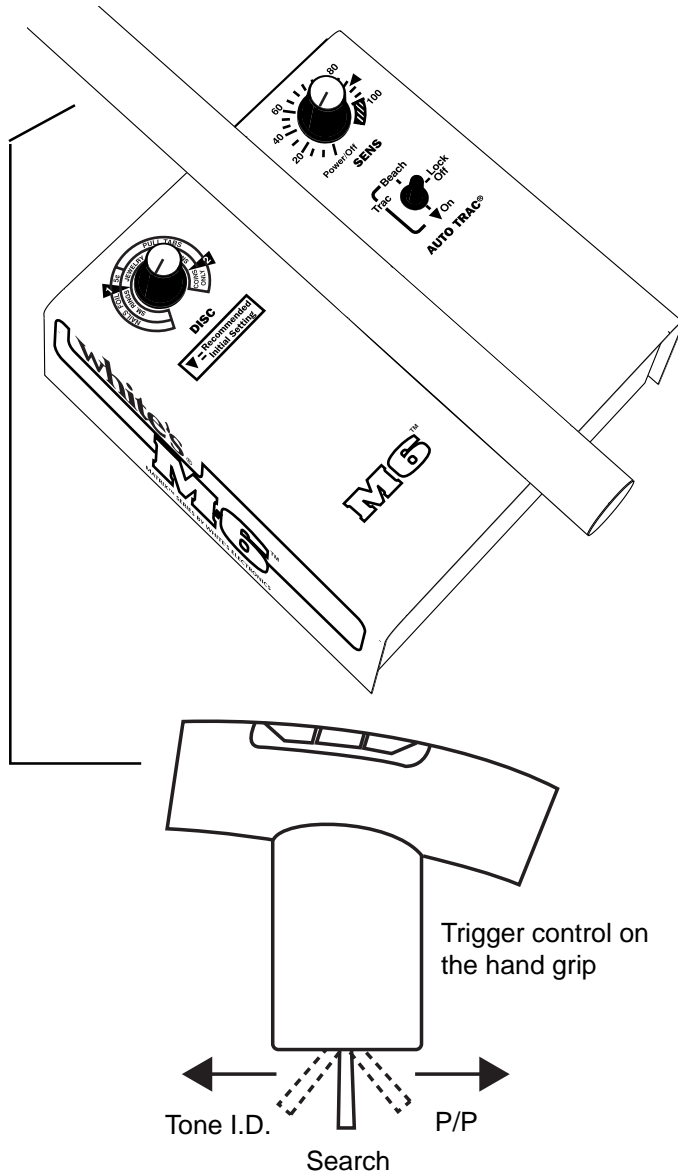

Trigger (on hand grip)

Center Position (Discrimination) "Search"

The DISC control works like most traditional metal detectors. Metal items below the DISC control setting are rejected (quiet or broken) by the audio ... metal items above the DISC control setting are accepted and produce a smoother, solid, and more consistent audio beep.

Forward Position "Tone I.D."

With the Trigger on the hand grip in the forward position and DISC set at minimum, seven different tones indicate the display categories from Iron "Lowest Tone" thru Coins "Highest Tone". This Tone I.D. feature makes the operator immediately aware of the likely category of the metal item without looking at the display. Each major Display category has its own tone. Display categories selected for rejection with the DISC control setting either produce no beep at all or a broken, inconsistent beep. In addition, a very low tone and a display reading of "OVERLOAD" appears when the search loop is too close to a large metal item.

Squeezed and held "Pinpointing/Depth Reading"

When the Trigger on the hand grip is squeezed and held, the display indicates the depth, in inches, of coin sized targets. Once released, the trigger will automatically return to the Center "Search" position.

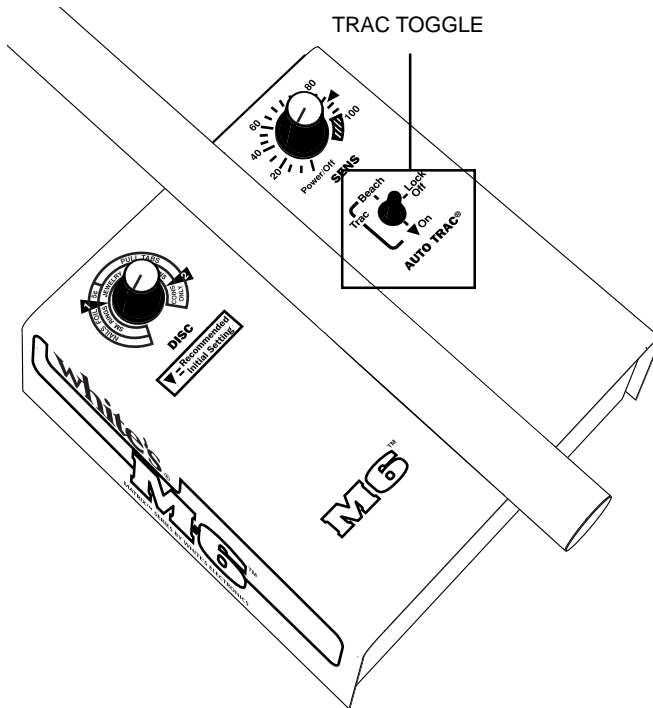

AUTO TRAC® Toggle

The TRAC toggle selects the type of ground mineral rejection (ground balance) and automatic tracking to ground mineral changes best suited to the specific area. Three different positions each for a specific ground condition (ground type) are provided.

The **On** position is used for normal or typical ground conditions. In this position the M6 will quickly compensate for ground minerals in a few pumps of the search coil over the ground being searched and quickly (automatically) track to any ground changes as you sweep the search coil during searching. For most operators, the On position will be used for over 90% of your searching conditions.

The **Lock** position monitors, but does not track to changing ground conditions. This position should be used when decomposing iron or other unstable ground conditions create noise and instability. This "noise" appears when patches of ground are vastly different from surrounding ground.

Find a "clean and quiet" area, pump the loop, and move the toggle to the "Lock" position. Update occasionally by moving the toggle to Beach or On and repeat the above step.

Eliminating Hot Rocks:

The "Lock" can be used to deal with rocks that contain much different minerals than the surrounding ground. (Referred to as hot or cold rock). This procedure is the reverse of the previous example. To eliminate hot or cold rock, balance DIRECTLY OVER the problem rock and move toggle to "Lock". This eliminates the ground response of the rock and detects targets only.

The **Beach** position provides an extended ground balance and tracking range to compensate for salt water beach and alkali. Ground rejection against salt water and alkali slightly overlaps the lower end of the conductive target (metal) range and may produce a very slight reduction in sensitivity to conductive targets. The advantage and performance improvements of rejecting saltwater, however, far outweigh any loss. The Beach TRAC is not recommended for normal conditions, only for saltwater beaches and areas known to contain salt.

Remember- When hunting in the "Beach" mode-balance in the "Beach" mode.

Summary - The **On** TRAC setting is recommended for most searching conditions. **Lock** is used to hold a ground rejection setting that is first established in the On or Beach TRAC positions. Lock is recommended for areas that cause detector instability due to extreme ground conditions such as a lot of decomposing man made iron. **Beach** provides extended ground rejection range to compensate for conductive saltwater or alkali conditions.

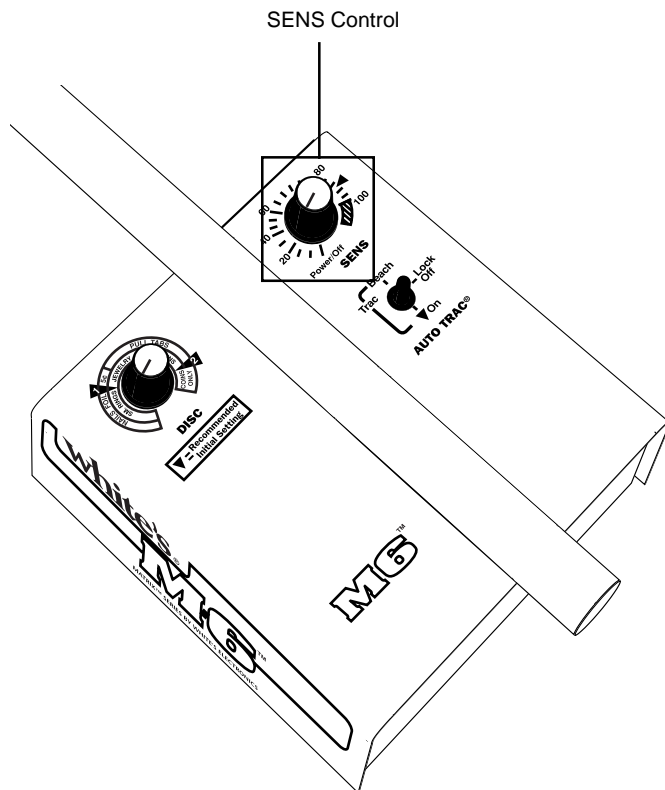

SENS Control/ON-OFF

The SENS control turns the instrument on/off and selects the signal strength. Increased signal strength does not always find more targets at greater depths. Sometimes high ground mineralization will "bounce" the signal back and mask good targets. It is therefore necessary to ADJUST the SENS to give you the maximum allowable SENS without masking targets or overloading

When ground mineralization is too high for the SENS control setting, the display indicates **"OVERLOAD-REDUCE SENS/LIFT LOOP"** along with an audible "squawk". Reduce the SENS until the overload warning ceases. On occasion, while searching, you might sweep the loop over a very large or very shallow target. The message on the LCD display will read **"OVERLOAD-REDUCE SENS/LIFT LOOP"**. Sweep the loop a little higher over the area and note the display and audio indications. The M6 will self correct after the message and you can continue to search as normal.

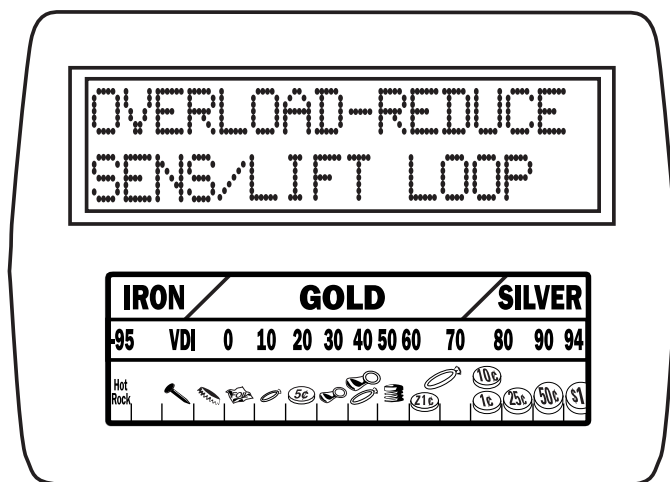

NOTE: Ground Mineralization too high, large or shallow target message.

SENS Adjustment

1. The SENS control knob turns the M6 ON and OFF and controls the SENS. Starting from the POWER OFF position and going clockwise, the power is turned ON and the dial increases the SENS from a minimum level of 1 to a maximum level of 100+. Set the control to the "Initial Setting Triangle" (between level 90 & 100).
2. Although the setting of 90-100 gives more than enough SENS, if the ground mineralization is low enough, you might attempt to raise the SENS above 100.

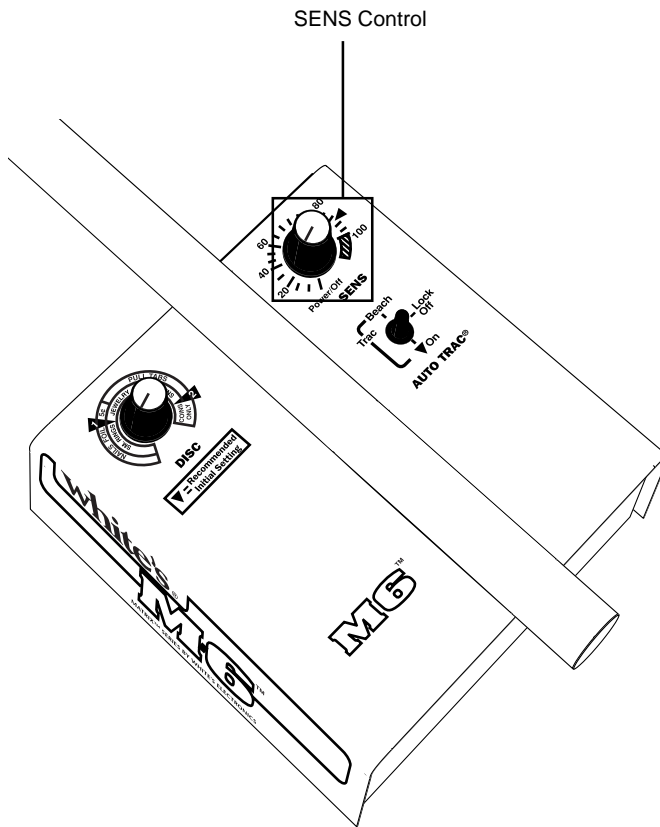

SENS Adjustment (continued)

If, of course, "OVERLOAD-REDUCE SENS/ LIFT LOOP" message is displayed, common for very nasty ground mineralization, you must heed it and reduce the SENS rather than raise it.

3. If the ground is highly mineralized, SENS settings well below this initial triangle may be necessary to identify metal items, and will still provide ample detection depth.

4. In addition, any increase in SENS adjustment should NOT BE at the expense of maintaining predictable results without false signals, beeps and static from bits of mineralization (erratic behavior).

SENS Adjustment (continued)

5. While using a steady slow search coil sweep speed, simultaneously advance SENS towards "100". If the "OVERLOAD-REDUCE SENS/ LIFT LOOP" alert keeps popping up on the display, or if ground noises make it difficult to recognize metal targets, reduce SENS counter-clockwise.

6. The trash I.D. capability of the M6 also functions more accurately when the SENS is set at a level which allows for smooth operation. Too much SENS can cause bad ground to distort the proper identification of iron and non-iron targets.

7. Note: It is normal to hear changes, clicks or soft beeps, coming from the audio (speaker) during SENS adjustments as the circuit shifts between hardware and software SENS (different electrical parts of the circuitry). The SENS control adjusts both the hardware SENS (physical component) as well as the software SENS (computer code) alternating between the two throughout it's range. As the M6 shifts between these two intricate parts of the circuitry an audio indication notes the transitions. This can be helpful. If you adjust the SENS slightly, the audio notes a significant rather than slight change.

8. The M6 provides more SENS control range than is typically useful. Few areas will allow maximum SENS (full clockwise) without at least some noisy operation. Settings in the 100+ area require a high degree of operator skill and patience.

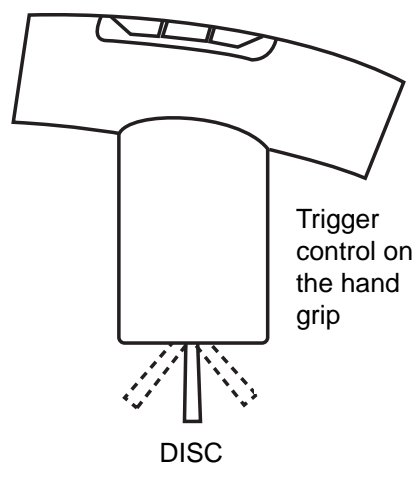
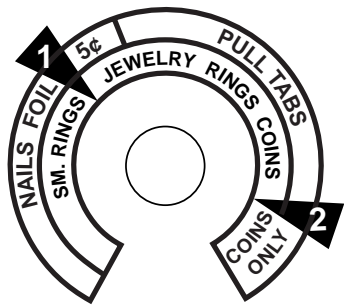
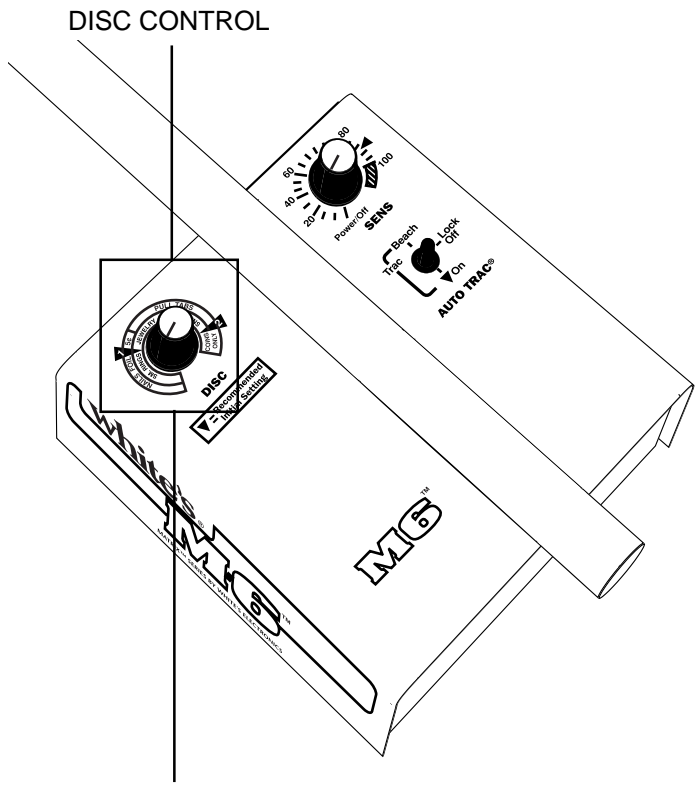

DISC (Discrimination) Control

DISC (Discrimination) is used to adjust the level of audio rejection against trash metals.

The ▼ (Preset) just below NICKEL is recommended for most general purpose searching. In this position, the detector will provide a reject response to most iron and small foil and respond to most valuables including jewelry.

Positions lower than ▼ (counterclockwise) provide less trash metal rejection, to the point of detecting virtually all types of common metals.

Positions higher than ▼ (clockwise) will reject more trash metals including aluminum pull tabs. **The display will continue to indicate I.D. even though the audio discriminator will signal with a reject (suppressed or broken) sound.** Nickels and some jewelry will also be rejected with DISC settings much greater than ▼.

The ▼ position is recommended. If, when searching at the ▼ position, you feel you are digging too much trash, adjust DISC slightly clockwise and try again. Finding the lowest (furthest counterclockwise) position that eliminates the common trash metals in your area is important in order to find items of jewelry.

The M6 provides two significantly different DISC (Discrimination) modes.

1. Traditional DISC

Put the Trigger on the hand grip in the center position. When a trash metal is being rejected it will produce no beep at all or a suppressed beep that is shorter sounding typically inconsistent, a click or flutter-sounding beep. When a valuable metal is accepted it will produce a consistent, smooth, solid, and longer sounding beep.

Some large trash metals, such as pieces of lead, pot metal, aluminum, tin, brass, copper, or significant grade iron will produce a good sound regardless of the DISC control position. An operator should dig these unusual scrap metals to be successful.

2. Tone I.D.

With the Trigger on the hand grip in the forward position, and the DISC control set at any typical rejection level, Tone I.D. is available. Iron, if accepted by the DISC control setting, produces the lowest pitched beep. Coin range targets (pennies and above) produce the highest pitch beep. Seven different pitch beeps are available for each major display category. Beep pitch is dictated by where that specific item indicates on the display. Some search coil motion is required to achieve detection and Tone I.D.

The loop must be in motion for metals to respond and provide accurate discrimination. Each pass of the loop from left to right (or from right to left) should overlap the last by at least 50% and take about two seconds.

NOTE* THE VISUAL I.D. SYSTEM IS OPERATING IN BOTH TOGGLE POSITIONS.

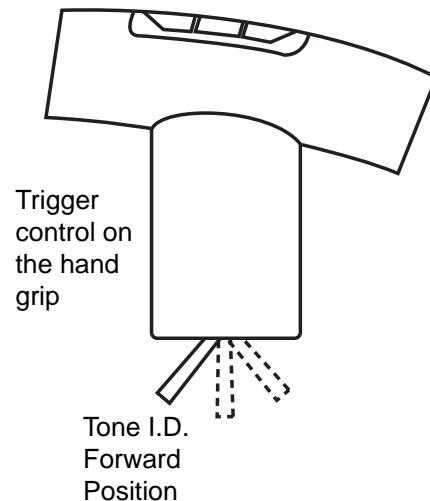

Find an outdoor area relatively free of metal to practice. Place a coin on the ground. Pass the loop over the coin. Note that some loop movement is necessary to receive a good clean sound. Note that if you sweep the loop too slow the coin doesn't respond well.

Pinpointing

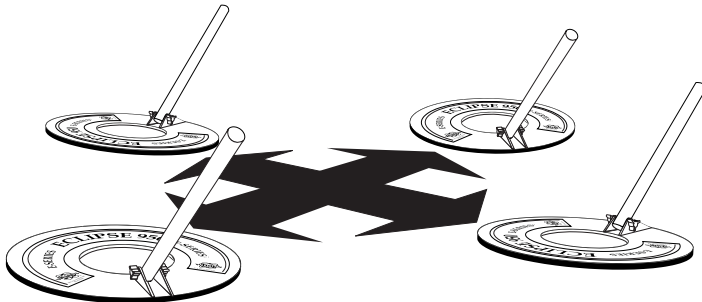

NOTE: Turn the detector 90° to the first side to side loop movement and repeat for "X"ing the center.

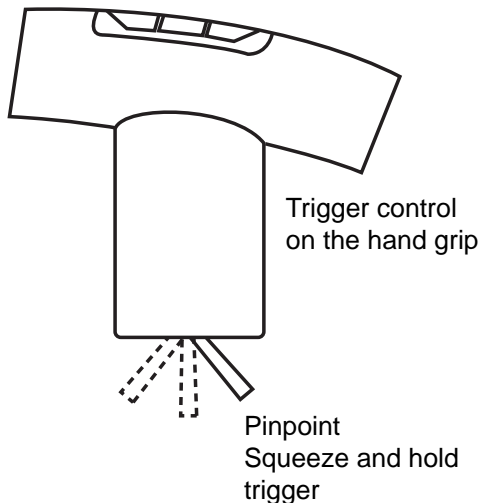

Pinpoint Technique

Due to the wide scan nature of modern search coils it can be difficult to locate small targets under the physical center of the loop. Use an "X marks the spot" technique as shown in the diagram to identify the portion of ground the metal target is in.

Squeezing and holding in the trigger on the grip accesses a pinpoint and depth reading mode that makes it much easier to sweep the search coil slowly and center directly above the target. Use loudest tone, display depth reading and bars, to indicate targets exact center.

Again, the procedure is to sweep over the target from side to side noting the side to side center. Then turn 90 degrees and sweep the coil side to side noting the center from this new direction. "X" marks the spot that you need to dig. You can practice with a coin on top of the ground to become acquainted with this technique.

Shallow targets, 0-3" depth readings, are more difficult to pinpoint than deeper targets. When shallow depth readings are noted, lift the loop several inches higher above the area, then X to pinpoint.



Headphones

The headphone jack on the M6 is located on the control box above the battery compartment. There is a dust cover on the headphone jack that needs to be removed before the stereo plug from the headphone is inserted. Replace it when headphones are not being used. Most users prefer high quality stereo headphones so White's has chosen to wire the headphone jack for stereo. If you have a mono headphone, you can purchase an adapter that will allow sound in both earpieces. Some headphones come with a switch for stereo or mono jacks.

In choosing headphones, make sure they have a VOLUME CONTROL as there is no target volume control on the M6. As well as comfort, headphones also avoid bothering others with a "beeping" box, and save on battery life. Many high quality headphones from full ear enclosure to lightweight summer models offering more safety in snake and bear country are available on the market. Higher impedance headphones (60 Ohms or greater) give the most sensitivity. Properly balanced impedance is important as well as low distortion.

Whites has several headphone models to choose from.

Field Use & Tuning Tips

1. **Trigger (on hand grip)** center " Search" position.
2. **TRAC** to On position.
3. **SENS** to "▼" position.
4. **DISC CONTROL** to DISC "▼".
5. **Pump the search coil** on the ground to be searched until ground ceases to respond.
6. **Move the coil** just over the ground and listen for the distinct repeatable beep produced by a good metal target. It is wise to plant metals just under the soil to practice on in order to learn to recognize what it will sound like. Planting a metal target disturbs the ground mineral, which usually reduces the depth it would have been found in undisturbed ground. It will take practice to determine the proper search speed and technique. Do not go too fast. Try to overlap your sweep path so that you won't miss the small and/or deeper metal targets.

7. Once a solid repeatable beep is located:

- A. Consult the display information.
- B. Squeeze and hold the Trigger on the hand grip and "X" the area to pinpoint and note how deep you will need to dig listed on the display.

OPTIONAL method for Pull Tab/Jewelry separation:

8. Once a solid repeatable beep is located

A. Push the Trigger forward and sweep the search coil over the target area.

1. If it beeps with a high pitch tone it is likely a coin worth digging, proceed with 2.

- a. If it beeps with a medium pitch tone it is in the Pull Tab range, Squeeze and hold the Trigger on the hand grip and check the depth. If it is shallow (0 - 2 inches) depending on the hardness of the ground, it is most likely a Pull Tab and should be ignored. If it is deeper (beyond 2 inches) depending upon the hardness of the ground, it is likely heavier gold jewelry and should be dug.

2. Consult the display information.

3. Squeeze and hold the Trigger on the hand grip and "X" the area to pinpoint and note how deep you will need to dig listed on the display.

9. **Heavy Pull Tab.** In areas littered with hundreds of Pull Tabs it may be necessary to search full time in Tone I.D. or with the "▼" DISC setting and save your time and efforts digging coins and jewelry that indicate outside the pull tab range.

10. Ground Mineralization:

A. For Salt/Alkali environments proceed exactly as above only with the TRAC toggle in the Beach position.

B. For areas with an abundance of decomposed man made iron (which may make the M6 appear unstable only during search coil sweeps), proceed exactly as above only once you pump the loop over the ground, then set the Trac control to Lock.

The M6 provides good general purpose searching for a wide variety of targets and environments.

From residential yards, parks and school grounds, farm fields to beaches (for salt beaches use Beach Trac setting).

Coins & Jewelry are the primary goals, however, these settings and features will also respond to any better alloy including common relics and any other item made of a valued metal alloy.

The 1st choice a user should consider is the selection of an appropriate TRAC toggle setting for the area. The On setting and Beach settings should be almost self explanatory. If you are searching in typical ground, use the TRAC On setting. If you are on a salt water beach or desert alkali, use the TRAC Beach setting. When to use the Lock setting can be less obvious. If it seems like something is wrong with the detector, wildly fluctuating (only while sweeping the search coil), try the TracLock setting. If the detector smooths out and starts operating more predictably, you made the correct choice. If there isn't any improvement, you may need to either reduce the SENS control setting counterclockwise and/or increase the DISC control setting clockwise. An area littered with man made iron would dictate the Lock setting. On the other hand an area littered with small aluminum foil would not, such an area would dictate the Reduced SENS and/or higher discrimination settings.

The 2nd choice is SENS. Some areas require, and some operators just prefer the more predictable operation reduced SENS settings provide, where as others prefer to push SENS to the limits of their patience to find the deepest targets. There is a point of diminishing returns either indicated by the display indicating OVERLOAD, or a user missing targets because they can not sort them out from sporadic noises experienced at too high of a SEN control setting.

The 3rd choice is the alternate MODE "Tone I.D." accessed by pushing the Trigger (on the hand grip) forward. Many prefer, after locating a target in the primary Trigger center position, to check targets with the Tone I.D. Others use the Tone I.D. as their primary search mode. It depends a lot on the area and degree of aluminum Pull Tabs present. Remember, the display will indicate if a metal target is in the Pull Tab range in either Trigger position. Also remember a metal target that indicates in the Pull Tab range however, provides a deep depth indication, is more likely to be jewelry than a Pull Tab. There are three types of targets that typically indicate in the Pull Tab range, Aluminum, Lead, Brass, and Gold. Without consistency in size/shape, all a metal detector can tell you is that it indicates within that range of targets. It is up to the operator to identify the common trash items of each area and then weigh the likelihood of good targets.

The 4th choice is the level of audio Discrimination. The "▼" setting provides a popular setting rejecting most iron and small foil and accepting nickels and most jewelry. Remember you have the display to further sort out accepted metals. However, if the common trash of the area consistently produces an audio to the point of distracting from finding anything at all, an operator can increase discrimination (clockwise)▼ and check the area for silver and copper. If a hot spot of multiple coins is located an operator may then want to search isolated spots within that area at lower discrimination settings. Even with modern discriminating metal detectors, it takes a good deal of patience to search high trash areas.

Information

Proper care

I. Cleaning

A. Both the coil and rod are waterproof and can be cleaned with fresh water and mild soap. The control box is not water proof and must be kept dry. **Never** lift a wet coil above the height of the control box as water can run down the inside of the rod damaging the electronics. A damp cotton cloth can be used to wipe off a dirty control box.

II. Weather

A. Do not expose your detector to the conditions of a car trunk during winter and/or summer extremes.

B. Protect it from direct sunlight during storage.

C. The control box is rain resistant, but must be protected from heavy rain.

III. Storage

A. When the instrument is not in use, make sure it is turned OFF.

B. If you plan on storing your detector for long, remove the battery holder from the instrument and remove the batteries from the holder.

C. Store the instrument indoors, in an area where it will be protected from abuse. Over the years White's has noted more service repairs and physical damage, on units in storage than those experiencing daily use.

IV. Additional Precautions

A. Avoid dropping your detector while attempting to set it down to dig.

B. Avoid using your detector for leverage when standing up from a dig.

C. Do not use any lubricants, such as WD-40®, on any part of your detector.

D. Do not modify your instrument during its warranty period.

Service

White's reputation has been built on quality products backed by quality service. Our Factory Authorized Service Centers are factory trained and equipped. They offer the same quality service as the factory. Service before and after the sale is the cornerstone of our customer relations.

White's Authorized USA Service Centers:

Centerville Electronics
10063 Wellington Road Road
Manassas, Virginia 20110
Toll Free 1-888-645-0202
Fax: 1-703-367-0868
E-Mail: centelec@vwx.com

Electronic Exploration
575 West Harrison
Lombard, Illinois 60148
Toll Free: 1-800-392-3223
Fax: 1-630-620-1005
E-Mail: tony@ee-il.com

White's Electronics, Inc.
1011 Pleasant Valley Road
Sweet Home, Oregon 97386
Telephone: 1-541-367-6121
Fax: 1-541-367-6629
E-Mail: nbaker@whiteselectronics.com

Before shipping detectors for service:

- A.** Contact your Dealer. There may be a quick, simple fix or explanation that will prevent having to send the detector in for service.
- B.** Double check the obvious, such as batteries, and try the detector in another area to be sure there is not interference.
- C.** Be sure to send all necessary parts with your detector such as search coil, batteries and holders.
- D.** Always include a letter of explanation about your concerns, even if you have talked to the Service Center by telephone.
- E.** Take care in packaging instruments for shipping and always insure your package.

Warranty

If within two years (24 months) from the original date of purchase, your White's detector fails due to defects in either material or workmanship, White's will repair or replace at its option, all necessary parts without charge for parts or labor.

Simply return the complete detector to the Dealer where you purchased it, or to your nearest Authorized Service Center. The unit must be accompanied by a detailed explanation of the symptoms of the failure. You must provide proof of date-of-purchase before the unit is serviced.

This is a transferable manufacturer warranty, which covers the instrument two years from the original purchase date, regardless of the owner.

Items excluded from the warranty are non-rechargeable batteries, accessories that are not standard equipment, shipping / handling costs outside the continental USA, Special Delivery costs (Air Freight, Next Day, 2nd Day, Packaging Services, etc.) and all shipping / handling costs inside the continental USA 90 days after purchase.

White's registers your purchase only if the Sales Registration Card is filled out and returned to the factory address by your dealer, soon after original purchase for the purpose of recording this information, and keeping you up-to-date regarding White's ongoing research & development.

The warranty does not cover damage caused by accident, misuse, neglect, alterations, modifications, unauthorized service, or prolonged exposure to corrosive compounds, including salt.

Duration of any implied warranty (e.g., merchantability and fitness for a particular purpose) shall not be longer than the stated warranty. Neither the manufacturer or the retailer shall be liable for any incidental or consequential damages. Some states however, do not allow the limitation on the length of implied warranties, or the exclusion of incidental or consequential damages. Therefore, the above limitations may not apply to you.

In addition, the stated warranty gives you specific legal rights, and you may have other rights which vary from state-to-state.

The foregoing is the only warranty provided by White's as the manufacturer of your metal detector. Any "extended warranty" period beyond two years, which may be provided by a Dealer or other third party on your detector, may be without White's authority involvement and consent, and might not be honored by White's Electronics, Inc.

Warranty Transfer

If for any reason you should sell your White's detector prior to the date the warranty expires, the remaining warranty is transferable. **This transfer is authorized by calling 1-800-547-6911, and getting an Authorization Number.**

Simply fill out the following information, including the Authorization Number, seal it in a stamped envelope, and send it to **White's Electronics, 1011 Pleasant Valley Road, Sweet Home, Oregon 97386.** The remaining warranty period will then be available to the new owner.

The Warranty Statement applies to both the original owner as well as the second owner.



 **WARRANTY TRANSFER**

Original Owner:

Name: _____

Address (Which appears on the original warranty card):

Instrument Serial Number: _____

Original Purchase Date: _____

New Owner:

Name: _____

Address: _____

Comments: _____

Distributor Authorization Code: _____

Owner Information

Serial Number: _____ (*inside of battery compartment*)

Purchase Date: _____ (*The date on the sales receipt*)

Dealer Name: _____

Address: _____

Telephone #: _____

Payment method: _____

Personal markings: _____

WHITE'S ELECTRONICS (UK) Ltd.
After Sales Service
LIMITED WARRANTY STATEMENT

The Serial Number which is unique to your unit is on a White Label inside the Battery Compartment.

Please quote the number on all correspondence regarding your detector.

White's Electronics have always been concerned with the absolute quality of their metal detectors. Service after the sale is of extreme importance to us and we always do our utmost to ensure that customers are satisfied with our units. If your unit should require servicing or repair, simply return it to us at the factory in Inverness and we shall carry out the necessary work for you.

Any work carried out by unauthorized persons will automatically nullify the warranty.

If within 2 years (24 months) from the original date of purchase, your White's detector fails due to defects in either material or workmanship, White's Electronics (UK) Ltd will repair or replace, at its option, all necessary parts without charge for parts or labour.

Simply return the Control Box, Searchhead and, if used - rechargeable battery and charger to our factory in Inverness giving details of the faults and contact details (Daytime telephone number if possible.) *Items excluded from the warranty are non-rechargeable batteries, and other accessories.*

The warranty is not valid unless the Warranty Registration Card is returned to the factory address within 10 days of purchase from the purpose of recording that date, which is the actual commencement date of the warranty.

The warranty does not cover damage caused by accident, misuse, neglect, alterations, modifications or unauthorized service.

Duration of any implied warranty (e.g.. Merchantability and fitness for a particular purpose) shall not be longer than the stated warranty.

Neither the manufacturer nor the retailer shall be liable for any incidental or consequential damages resulting from defects or failures of the instrument to perform.

This warranty does not affect your statutory legal rights.

White's Electronics (UK) Ltd
35 Harbour Road ~Inverness ~ Scotland ~ IV1 1UA
Telephone: (01463) 223456 Fax: (01463) 224048
Email: sales@whelects.demon.co.uk
Web site: www.whites.co.uk

WARRANTY TRANSFER

If for any reason you should sell your White's Metal Detector prior to the date the warranty expires, the remaining warranty may be transferable.

Simply fill out the Warranty Transfer form below, send it to White's Electronics (UK) Ltd, 35 Harbour Road, Inverness, Scotland, IV1 1UA. White's will then advise you what, if any Warranty is available.

The Warranty Statement must be completed with Serial number and information on previous and new owners.



WARRANTY TRANSFER

Original Owner:

Name: _____

Address (as on original Warranty Card):

Serial Number: (inside battery door) _____

New Owner:

Name: _____

Address: _____

Tel: _____ Email: _____

To see complete details or to purchase the White's Matrix M6 Metal Detector, visit:
<http://www.metaldetector.com/whites-matrix-m6-metal-detector>

A message from ...

**Kenneth R. White, President
White's Electronics, Inc.**



metal detectors

It is with pride that we put our American Made label on every metal detector we build. At our facility here in Sweet Home, Oregon, we've been proudly building the world's finest metal detectors in the world for over fifty years now.

It starts in Marketing and Engineering with a plan using the very latest technology to design detectors better than ones before. Once we've thoroughly tested and refined a new design in the field, it's ready for production. We take raw metal, bend, paint, bake and silkscreen to form a housing. Wire is wound, plastic is formed, and foam is inserted to construct a loop. Rods are bent and punched. Boards are stuffed and soldered. Knobs and displays are added. Manuals and catalogs are designed and written right here.

At every step of the way, quality is foremost. Each detector is quality checked after each process, and bench-tested one more time before it goes out the door. And if you need service, our Customer Service Department does their best to repair your detector quickly so you can get back out in the field.

Finally, finished detectors are shipped out the door here in Sweet Home to virtually every corner of the world.

It has always been my philosophy to keep our people working by keeping our customers happy. I'm proud of our metal detectors, and of the people here at White's who build them for you.

White's Electronics, Inc.
1011 Pleasant Valley Road
Sweet Home, Oregon 97386
USA
www.whiteselectronics.com

621-0493-1

Distribution: 1-800-547-6911
Factory: 1-541-367-6121
FAX: 1-541-367-6692
email: info@whiteselectronics.com

**To see complete details or to purchase the White's Matrix M6 Metal Detector, visit:
<http://www.metaldetector.com/whites-matrix-m6-metal-detector>**