

Gold  
**RACER**

# USER GUIDE



**2 YEARS**  
WARRANTY

**MAKRO**  
METAL DETECTORS

[www.makrodetector.com](http://www.makrodetector.com)

## READ CAREFULLY BEFORE OPERATING THE DEVICE!

### LEGAL DISCLAIMERS

Comply with the laws and regulations in force within the area while using the device. Do not use the device in protected or archeological sites and military zones. Notify any historical and cultural artifacts you find to the concerned authorities.

### WARNINGS

**GOLD RACER** is a state-of-the-art electronic device. Do not assemble or operate the device before reading the user manual.

Do not keep the device and search coil under extremely low and high temperatures for extended periods. (Storage Temperature: - 20°C to 60°C / - 4°F to 140°F).

Do not immerse the device and its accessories (except for the search coil) in water or keep them in excessively humid environments.

Protect the device against impacts that may occur during shipping in particular.

**GOLD RACER** may only be disassembled and repaired by authorized service centers. Disassembling the device for any reason voids the warranty.

# Table of Contents

Assembly .....	1
General Description of the Device .....	2
Battery Details .....	3
Display.....	4
Correct Use.....	5
Quick Guide.....	6
Menu.....	7
Search Modes.....	7-10
Settings Common to All Modes.....	11
Ground Balance.....	12-15
Sensitivity, iSAT, Threshold and iMask.....	16-17
Target ID and ID Filtering.....	17-18
Other Settings Not Shown on Screen.....	19
Pinpoint.....	19-20
Target Distance.....	20
Swinging Speed and Target Identification.....	20
Large or Near-Surface Targets.....	20
False Signals and Reasons.....	21
Magnetic Mineralization Indicator.....	21
Rocks and Searching in Rocky Terrains.....	21-22
Tracking and Effects of Rocks.....	22-23
Metals Under Rocks.....	23
Messages.....	23-24
Technical Specifications.....	24

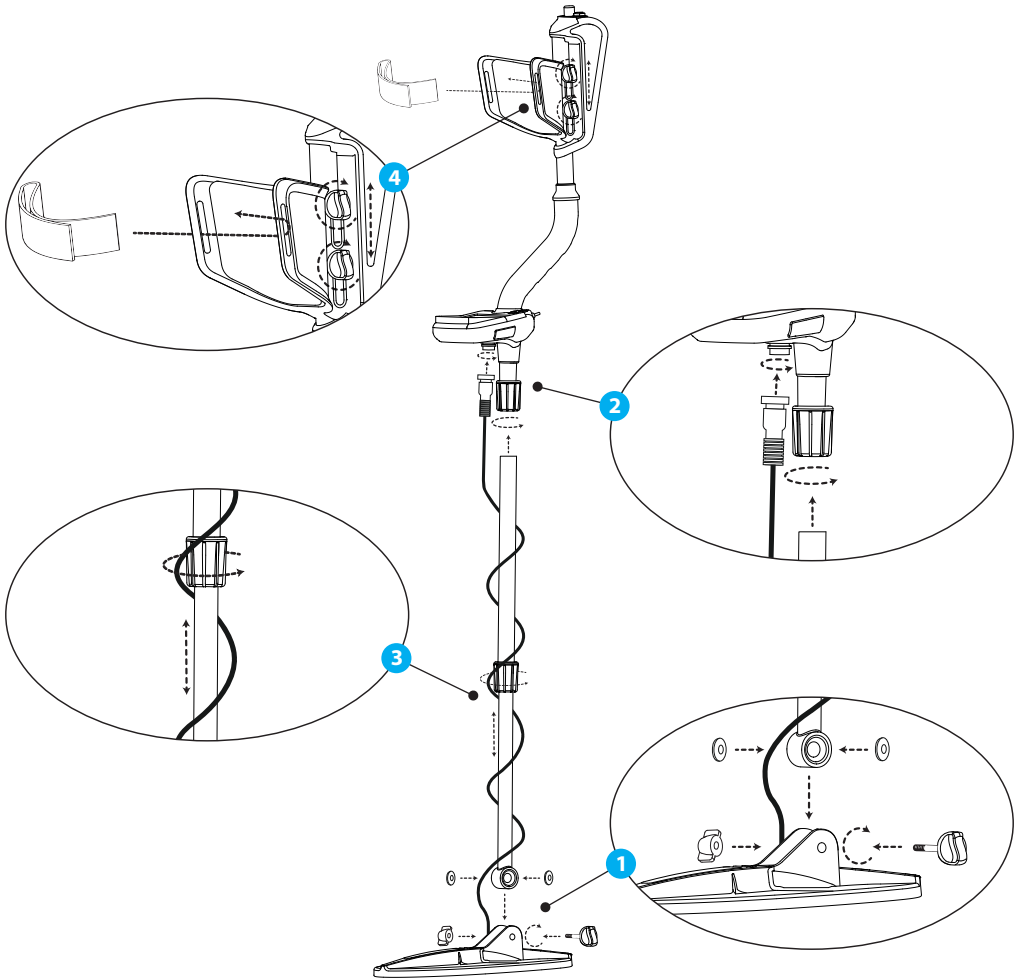

- 1 Insert the washers as shown on the telescopic shaft. Install the telescopic shaft to its location on the search coil. Secure by tightening the screw and nut.
- 2 Loosen the twist lock before mounting the telescopic shaft to the upper rod. Press down the pin and engage the pieces together and tighten the twist lock after the pin is clicked into the hole. Wind the cable of the search coil on the telescopic shaft without stretching too much. Plug the connector on the cable to the search coil input socket on the system box and secure by tightening the nut.
- 3 Loosen the twist lock of the telescopic shaft to extend or shorten it. Adjust the length of the shaft by keeping the pin located on the rear pressed down and clicking the pin in any of the holes. Secure by tightening the twist lock.
- 4 Insert the armrest band through its slot as shown in the figure. Loosen the screws and adjust the armrest position to your comfort by sliding it down or up and secure by tightening the screws.

## General Description of the Device



- 1 Display showing all settings and information.
- 2 Wireless headphone module jack (wireless headphones are sold separately).
- 3 Keypad for navigation among menu options and changing the device settings.
- 4 Ground balance and pinpoint trigger.
- 5 Speaker.
- 6 Battery compartment cover.
- 7 On /Off and volume adjustment button.
- 8 Wired headphone jack.
- 9 Search coil connector socket.
- 10 LED flashlight.

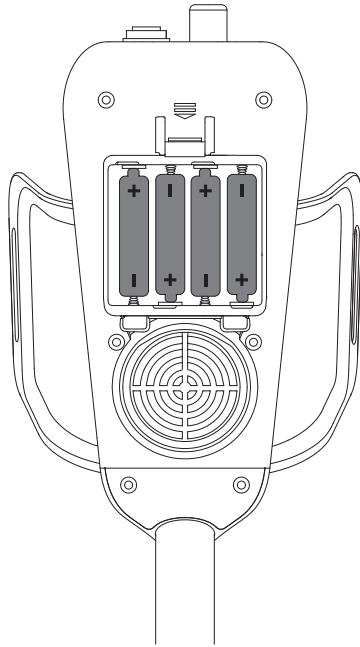

The device is supplied with 4 pieces of AA Alkaline batteries.

To remove the battery compartment cover, press on the latch and pull out. Insert the batteries observing correct polarity of + (plus) and - (minus).

The device can be used for approximately 25-30 hours when the batteries are fully charged. Operating time of other brands and types of batteries available on the market may vary.

AA Alkaline batteries are recommended for the best performance. Good quality Ni-MH rechargeable batteries can be used, too. Rechargeable batteries with high mAh (capacity) ratings offer extended operating times than batteries with lower rating. We recommend use of minimum 2500mAh batteries.

### **Low Battery Level**

Battery icon on the display shows the battery life status. When the charge decreases, the bars inside the battery icon decrease, too. "Lo" message appears on the display when the batteries are depleted and the device shuts down after a short period.

# Display

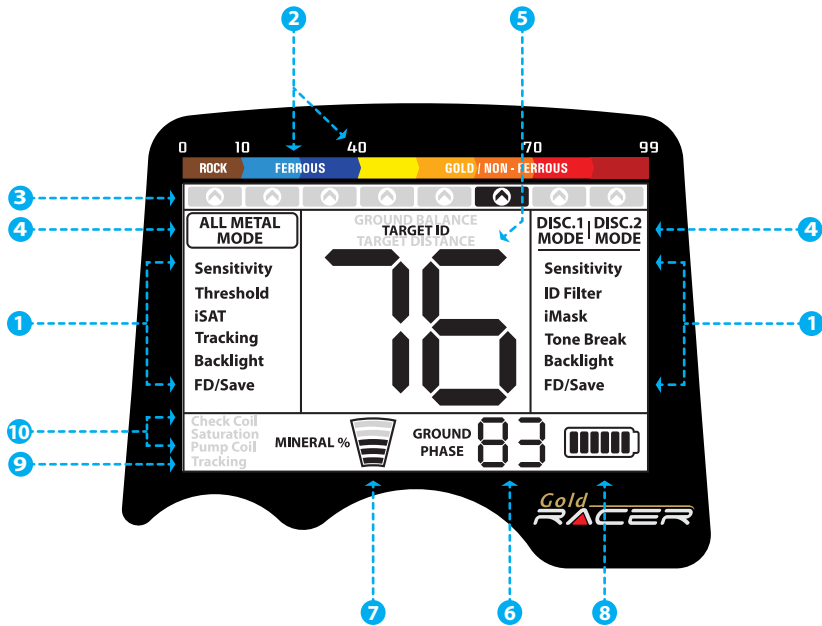

- 1 Menu providing access to all settings of the device.
- 2 Target ID and color scale.
- 3 Cursor indicating the ID of the detected target and its position on the color scale. It is displayed by itself when the target signal is weak and in a black box when the signal is strong.
- 4 Search modes.
- 5 Section which shows the Target ID during search, the ground balance value during ground balance adjustment and the estimated target depth during the pinpoint process. Also, the numeric value of any setting selected from the menu is displayed in this field.
- 6 Section which shows the fine tuning value during ground balance adjustment and current ground balance value during search.
- 7 Magnetic mineralization indicator.
- 8 Battery level indicator.
- 9 Tracking on / off status indicator.
- 10 Section which shows the warning messages.

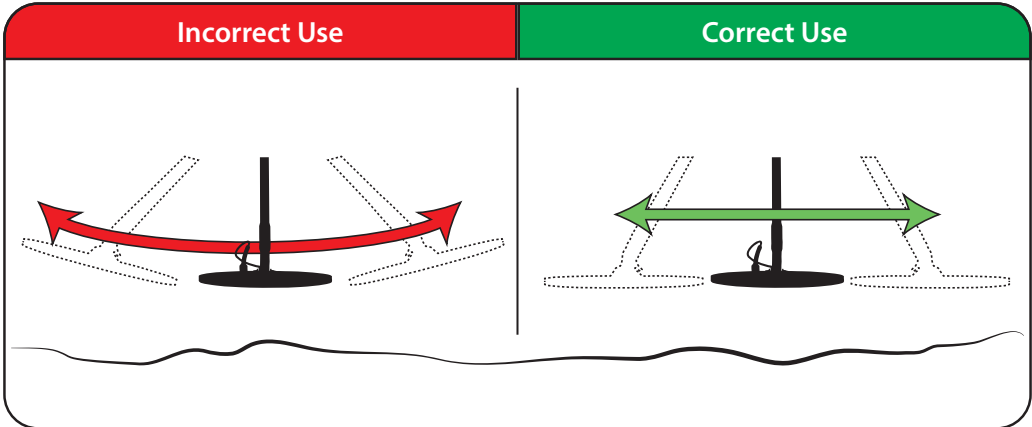
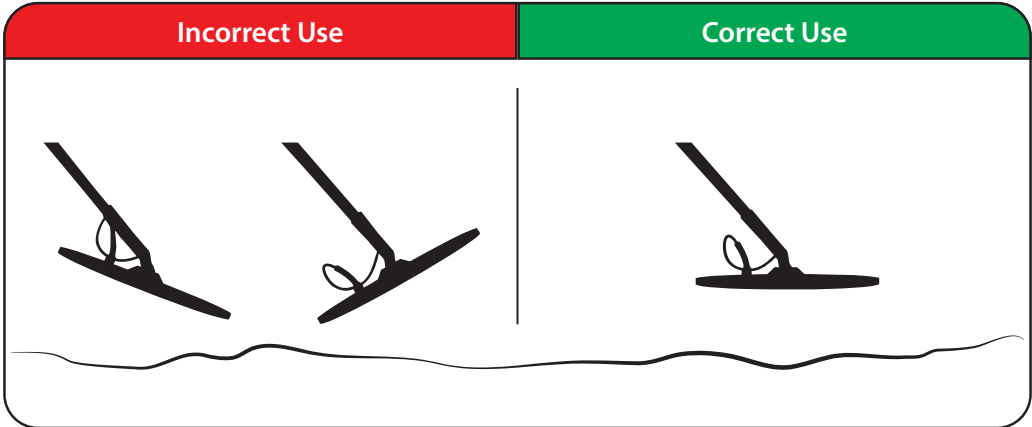
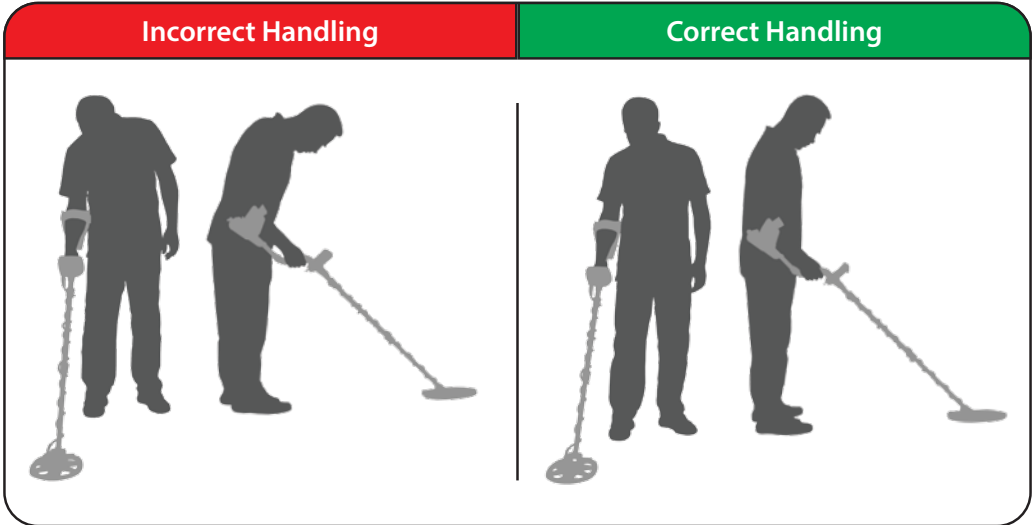



- 1 Assemble the device as per the instructions on page 1.
- 2 Insert the batteries by paying attention to +/- polarity.
- 3 Rotate the on/off switch located behind the device clockwise to turn on the device. This switch also adjusts the volume.
- 4 When the device is turned on, it will start in the All Metal mode. You can change the mode based on the area that you are searching.
- 5 To ground balance, push and hold the trigger forward and pump the search coil up and down 3cm (1.2") above the ground until a "beep" sound is heard.
- 6 You can increase the sensitivity if needed. Increasing the sensitivity will offer you greater depth. However, if the surroundings or the ground cause excessive noise in the device, you need to lower the sensitivity setting.
- 7 If the device receives a lot of ground noise in the All Metal mode causing a disruption in the threshold's stability, you can increase the iSAT value.
- 8 If the ground is highly mineralized causing the coil to overload, decrease the sensitivity until the "Saturation" message disappears from the screen.
- 9 Testing with various metals in discrimination modes is useful for getting familiar with the sounds produced by the device.
- 10 Based on the IDs of the metals you don't want to detect, you can set the ID Filter and ignore those metals. For instance, if you don't want to detect ferrous metals with 20 ID, you can adjust the ID Filter to 21.
- 11 You can now start searching.
- 12 Since your device operates with the motion principle, swing the search coil right and left maintaining 5cm (2") distance above the ground. If the search coil does not move, the device will not provide any warning tones even if the coil is over a metal target.
- 13 When a target is detected, the ID of the target is displayed on the screen and the cursor indicates its position in the ID and color scale. The device also produces a warning tone based on the search mode selected.
- 14 Upon target detection, you can pinpoint the exact location of the target by pulling and holding the trigger back.

The device starts in the All Metal mode. You can change the mode using the +/- buttons.

Select a setting from the menu by using the up/down buttons. The value of the selected setting is shown on the display. You can change the value by using the + and - buttons.

If up/down and +/- buttons are kept pressed for a certain period, options and values change more rapidly.

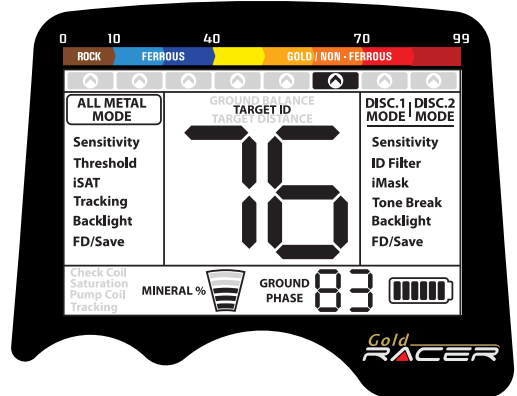

If no button is pressed for a while after selecting a setting or changing its value, the selection cursor automatically returns back to the selected mode. Pulling the trigger eliminates the waiting time.

## Search Modes

3 search modes adapted to different ground conditions and target types are offered by the **GOLD RACER**. Names of the search modes are defined as All Metal, DISC.1, and DISC.2 on the screen. You can easily switch between the modes by using the direction keys during your search. The name of the selected mode is shown framed on screen. While in settings, the selection cursor appears on the selected setting and the current mode name is underlined. The settings for All Metal mode appears on the left side of the screen and the settings for both discrimination modes appear on the right. Some settings are common to all modes. For more details, please read the explanations for settings of each mode carefully.

### All Metal Mode

It is the deepest mode of the device. Different than the discrimination modes, this mode features a threshold tone which is continuously heard in the background.

The device does not discriminate targets while in the All Metal mode and detects all targets (metal, mineralized rocks etc.). ID of the detected target is shown on the display (except for negative hot rocks) and the same warning tone is provided for all targets. The warning tone increases in pitch as the target is approached.

Sensitivity, threshold and iSAT settings in this mode are set to default values which provide the best performance on different terrains. You can modify these settings based on ground conditions.

### Settings for All Metal Mode

#### Sensitivity

It is the depth setting of the All Metal mode. It is also used to eliminate the ambient electromagnetic signals from the surrounding environment and noise signals transmitted from ground.

Sensitivity setting range is 01-99 and it is set to the factory default at the initial start-up. It can be manually modified when necessary.

**NOTE:** In case of the coil overloading due to very high mineralization, decreasing the sensitivity will overcome the situation.

For more details, please read Sensitivity, Threshold, iSAT and iMASK section on pages 16-17.

## Threshold

This setting is used to adjust the humming sound, referred to as the threshold sound, which is continuously heard in the background in the All Metal mode. It is used to increase the target signal, in other words, the depth of the device. For more details, please read Sensitivity, Threshold, iSAT and iMASK section on pages 16-17.

## iSAT

For the All Metal mode to perform accurately, a stable threshold sound is necessary. Changes in mineralization and soil structure may cause a rise or fall in the background hum and disrupt the threshold's stability which will result in losing target signals of certain metals such as small gold nuggets. iSAT feature maintains the steadiness of the threshold by adjusting the speed the device recovers its threshold sound.

iSAT consists of 10 levels. The device will start at level 6. It is recommended that iSAT should be increased in high-mineralization and decreased in low mineralization. For more details, please read Sensitivity, Threshold, iSAT and iMASK section on pages 16-17.

## Audio Boost

**This feature is not included in the settings on screen.** The audio boost switch boosts the sound of weak signals received from small or deep targets making it easier for you to detect those uncertain targets. It is recommended that audio boost should be used on a temporary or as-needed basis because it will not only boost the target signal audio but it will also boost the loudness of ground noise and false signals along with the threshold hum.

For an instant audio boost, push and hold the (-) button during searching. To exit, just release the button. If you want to use the audio boost constantly, double click the minus (-) button. The frame around the ALL METAL MODE text will start blinking indicating that the audio boost is active. To exit, double click the (-) button again.

**NOTE:** When you want to use the Audio Boost function, be sure that you are not in the settings menu and the selection frame is around the ALL METAL MODE text.

## Audio Tone

**This feature is not included in the settings on screen.** It is the setting which allows you to change the target warning tone and the threshold sound according to your preference. There are 2 audio frequencies available - low tone (LF) and high tone (HF). To change the audio tone, keeping the trigger pulled back, press the down button.

## Discrimination Modes (DISC.1 and DISC.2)

Different than the All Metal mode, there is no threshold in these modes and the device emits a warning tone only when a target is detected. If the sensitivity level is not set properly, you can hear a crackling sound in these modes. Therefore, the sensitivity should be adjusted to a level that the device is silent when there is no metal present.

Discrimination modes have some common features but they have slight behavioral differences. ID Filter is a common feature, used frequently in these modes. ID Filter values are preset by the factory for these modes. If you want, you can change these values based on field and ground conditions.

### DISC.1

It is the 2-tone discrimination mode designed for tough gold fields with high mineralization or positive hot rocks. It offers slightly less depth but faster target detection and recovery speed in highly mineralized soils compared to the other modes.

### DISC.2

It is the 2- tone discrimination mode designed for cleaner gold fields with milder mineralization. It provides more depth compared to the DISC.1 mode.

In the DISC.1 and DISC.2 modes, the device will produce a low tone for iron and positive hot rocks. For all other metals, it will produce a single tone just like in the All Metal Mode, which increases in pitch as the coil approaches the target.

To get familiar with the warning audio tones, we recommend you to test the device with different metals and hot rocks before you use it in the field.

When using the discrimination modes, if you record the IDs of the rocks in the field and then filter them using the ID Filter feature, nugget detection will be more convenient. When filtering IDs, you must use the ID value closest to the ID of the rocks. Otherwise, you may miss the nuggets under the rocks. Consequently, you may need to change the default ID Filter value(10) of these modes to another value based on the IDs of the rocks in the field. For more details on eliminating hot rocks, please read the related sections (Target ID and ID Filtering, Rocks and Searching in Rocky Terrains and Metals Under Rocks).

If you dig a target signal in a gold field and find rocks, be sure that there is no small gold nugget underneath.

## Settings for Discrimination Modes

Although the settings for discrimination modes (Sensitivity, ID Filter and iMask) appear underneath both modes, the changes made in one applies to that mode only and does not affect the other discrimination mode.

### Sensitivity

It is the depth setting of the All Metal mode. It is also used to eliminate the ambient electromagnetic signals from the surrounding environment and noise signals transmitted from ground.

**NOTE:** In case of the coil overloading due to very high mineralization, decreasing the sensitivity will overcome the situation.

Sensitivity setting range is 01-99 and it is set to the factory default at the initial start-up. It can be manually modified when necessary.

For more details, please read Sensitivity, Threshold, iSAT and iMASK section on pages 16-17.

### ID Filter

Target ID is the number produced by the metal detector based on the conductivity of the metals and gives an idea to the user about what the target may be. Target ID is shown with two digits on the display and ranges between 01-99.

ID Filter is the ability of the device to ignore unwanted metals. In other words, the detector will not provide a warning tone or a target ID when such metals are detected. It provides ease of use by rejecting mineralized rocks (hot rocks) and metals such as iron and foil.

ID Filter value is pre-set for DISC.1 and DISC.2 modes. You can adjust the ID Filter manually according to your personal preferences. See TARGET ID and ID FILTER section for further information (pages 17-18).

### iMask

It is used to eliminate false signals caused by ground noise or hot rocks when searching in discrimination modes and it values between 0-6. Its factory default value is set to 1. You can change the value using the plus (+) and minus (-) buttons.

For more details, please read Sensitivity, Threshold, iSAT and iMASK section on page pages 16-17.

### Tone Break

It is used to adjust the break points of the target response tones on the TARGET ID range. As the factory default, the device emits a low tone for ferrous metals with target IDs equal to or less than 40. For gold and non-ferrous metals with 41-99 IDs, it produces a high tone. By using the Tone Break feature, you can change the point where the low tone changes into the high tone.

To be able to do this, first select the Tone Break setting on screen. Factory default 40 will be displayed. Adjust the value by using the plus (+) and minus (-) buttons. Let's say you changed it to 20. In this case, the device will produce a low tone for all metals with IDs equal to or less than 20 and a high tone for metals with IDs greater than 20. To give another example, let's say you increased the tone break point from 40 to 65. In this case, the device will produce a low tone for all metals with IDs equal to or less than 65 and a high tone for metals with IDs greater than 65.

Deeper or small nuggets or nuggets underneath or next to rocks tend to give a ferrous like response resulting in not being able to hear the target signals clearly. Using the tone break feature to adjust the low tone breakpoint to a lower number will help in hearing the target signals more clearly.

## Tracking

Although the Tracking feature appears under the ALL METAL mode, it is actually a common feature to all modes so when it is turned on, it becomes active in all modes. The reason it appears on the left side of the screen only is that the use of tracking is recommended in the ALL METAL mode and not in the discrimination modes. After using Tracking in the ALL METAL mode, if you switch to the discrimination modes and do not want to use tracking you need to select it in the menu again and turn it off.

When tracking is active (01 position), the device continuously tracks the changing ground structures and automatically reconfigures the ground balance setting. The invisible changes in ground affects the detection depth as well as the discrimination ability of the device so it is possible to operate the device at higher performance using this feature under suitable ground conditions. You can find more details on tracking on page 14.

## Backlight

It enables you to adjust the keypad and display backlight level according to your personal preferences. It ranges between 0-5 and C1-C5. At 0 level, the keypad and display backlight are off. When set between 1-5, it lights up only for a short period of time when a target is detected or while navigating the menu and then it goes off. At C1-C5 levels, it will light up constantly. As the constant operation of the backlight will affect power consumption, it is not recommended.

The backlight setting is restored to the final saved setting when the device is turned off and on again. This setting is common in all modes; change made in any mode also applies to the other modes.

## Factory Default /Save (FD/Save)

With the FD/Save feature of the **GOLD RACER**, you can save your settings or restore factory defaults. This setting appears on both sides of the screen and has the same function. Save function saves all settings except for the ground balance and the Audio Boost in the All Metal mode. The device starts in the last mode where the save function was performed. For example, you changed the settings of both the All Metal mode and the discrimination modes and you saved the settings while in the DISC.1 mode. Your device will start in the DISC.1 mode upon next start up.

To save your settings, select FD/Save on screen. SA will be displayed. To confirm, pull the trigger once and release. SA will stay on screen for a short period of time and it will disappear when saving is completed.

To restore factory defaults, select FD/Save on screen and press the minus (-) button. FD will be displayed. To confirm, pull the trigger once and release. FD will stay on screen for a short period of time and it will disappear when the process is completed.

## Ground Balance

Ground balance can be performed by three ways in **GOLD RACER**: Automatic, Manual and Tracking.

If the trigger is pushed forward while performing automatic or manual ground balance, the device will switch to the All Metal mode automatically on the background without any indication to the user, regardless of the selected search mode.

Upon completion of ground balance, current ground balance value is shown next to the GROUND PHASE text in the bottom of the display.

### Automatic Ground Balance

Automatic ground balance is performed as follows in all search modes:

1. Find a spot where there is no metal.
2. Push the ground balance trigger forward (GROUND BALANCE value and "Pump Coil" warning message is shown on the display) and start pumping the search coil up and down from about 15-20 cm (~6"- 8") above the ground down to 3 cm (~1") off the ground with smooth movements and keeping it parallel to the ground.
3. Continue until a beep, indicating the completion of ground balance, is heard. Based on ground conditions, it usually takes about 2-4 pumps for the ground balance to be completed.
4. Upon completion of the ground balance, ground balance value is shown on the display. The device continues to ground balance and produce a beep sound as long as you keep the trigger pushed forward and pump the coil. In order to ensure that the ground balance is proper, ground balance at least 2-3 times and check the ground balance values on the display. In general, the difference between the values shall not be higher than 1-2 numbers.
5. If you cannot ground balance, in other words, if no beep sound is produced, it means that either the ground is too conductive or not mineralized or there is a target right below the search coil. In such a case, retry ground balance at a different spot. Perform manual ground balance if it still fails.

When the ground balance trigger is released, the device continues to operate in the All Metal mode for a short period of time and ground balance value stays on the display. This makes it possible to manually fine tune the automatic ground balance value. Refer to the following Manual Ground Balance section for further information regarding this feature. If this is not desired, pull and release the trigger once to return to the main screen.

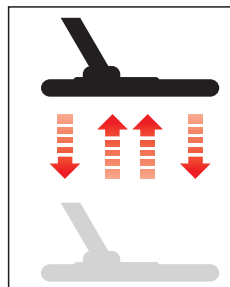
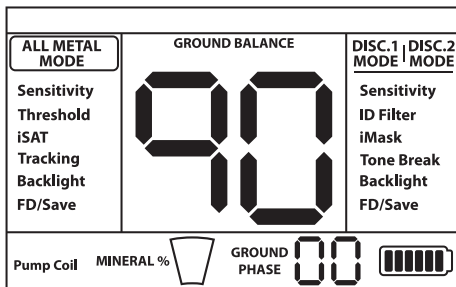
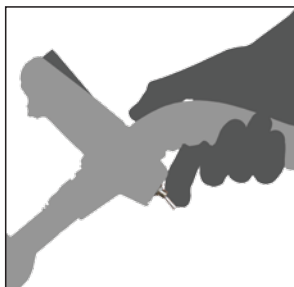

## Manual Ground Balance

Allows you to manually modify the ground balance value. It is not preferred mostly because it takes time. However, it is the preferred option in cases where a successful ground balance cannot be performed using other methods or minor corrections are required to the automatic balance.

**GOLD RACER** is designed to allow for automatic ground balancing conveniently on any type of ground. Therefore, it is recommended to perform automatic ground balance upon start up. However, the ground may not be suitable for automatic ground balancing in some cases and the device cannot ground balance on such grounds. For instance, wet beach sand, soils containing alkali or salty water, lands with high waste metal content, ploughed fields, high mineralized grounds and grounds with very low mineralization are not suitable for automatic ground balance. We recommend manual ground balancing for making it easier to search in such areas. Manual ground balance requires a skill which develops over time through practice.

### For performing manual ground balance:

1. Find a spot without metals and switch the device to the All Metal mode.
2. You need to listen the sounds coming from the ground in order to perform manual ground balance. Pump the search coil up and down from about 15-20 cm (~6"- 8") above the ground down to 3 cm (~1") off the ground with smooth movements and keeping it parallel to the ground.

If the sound gets higher when lifting off the search coil above the ground, the ground balance value is too low, in other words, the effect from the ground is negative and the ground balance value needs to be increased by using the (+) button. On the other hand, if the sound gets higher when lowering the search coil to the ground, the ground balance value is too high, in other words, the effect from the ground is positive and the ground balance value needs to be decreased by using the (-) button.

3. Push the ground balance trigger forward once and release it. The ground balance value will be shown on the display and remain there for a moment. You can return to the ground balance screen by pushing the ground balance trigger forward if the screen switches.

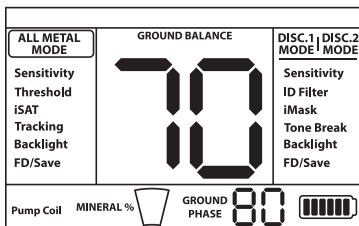

Manual ground balance functions within the range of 0-99. However, each value covers 5 steps used for fine tuning within itself and these steps are indicated as multiples of 20 in the Ground Phase indicator shown on the display. For example, ground balance value shown on the side is 70.80.

Press (+) and (-) to increase and decrease the ground balance value, respectively. If the key is pressed once at a time, the values count one by one and if kept pressed down, they change quickly.

4. Repeat the above procedure until the sound heard from the ground is eliminated.



The sound may not be eliminated completely in some areas. In these cases, listen to the sounds produced when moving the search coil towards and away from the ground to check if the ground balance is correct. If there is no difference between the two sounds then the ground balance is set properly.

The device will return to the main screen automatically after a moment upon completion of ground balance. To return immediately, just pull and release the trigger once.

**IMPORTANT!** Experienced detectorists adjust the ground balance setting to little positive response (weak but audible sound is produced when moving the search coil closer to ground). This method may produce favorable results for experienced users in certain fields where small gold nuggets are searched for.

## Tracking

In this option, the user does not need to make any adjustments. TRACKING feature is activated from the menu by switching it to 01 position. The word "Tracking" is displayed on the left bottom corner of the screen. The device updates the ground balance automatically as long as the search coil is swung over the ground and shows the ground balance value next to the GROUND PHASE text in the bottom of the display. It does not provide any feedback to the user (like ground balance value or a beep sound in automatic ground balance).

While Tracking is active, the device can initially produce a loud signal when it detects a different ground structure (for instance a mineral rock) or a target. In this case, swing the search coil over the spot where the device produces the signal. If the sound remains the same and the device shows an ID, it is possibly a target. If the sound attenuates too much or is lost after a few swings, it means that the device has produced a signal for the different ground structure or a stone.

It is recommended that you use Tracking in the All Metal mode and not in the discrimination modes (DISC.1 and DISC.2) for the best performance.

Tracking is suitable for use in areas where different soil structures are present within the same land, steep and broken fields or in fields where mineral rocks are scattered widely apart. If you use Ground Tracking in areas where hot rocks are intensely present, the device may not be able to eliminate these high mineralized rocks or you may miss the smaller (such as gold nuggets) or deeper metals.

**IMPORTANT!** Ensure that Tracking is off during air tests. Otherwise, the device attempts to perform ground balance on the target and the depth is reduced.

## Ground Balance Value

Ground balance value provides information about the ground you are searching on. Some typical ground types are as follows:

- 0-25 Wet salt water or wet alkali soils.
- 25-50 Wet salt water and wet alkali soils covered with dry layers.
- 50-70 Regular, low-quality soils.
- 70-90 Highly magnetic soils, magnetite or maghemite and similar highly mineralized soils, black sand.

## Important Details Concerning Ground Balance

1. Upon start up, the ground balance value is set as 90. The device can perform ground balance automatically within the range of 20-90 in all modes.

2. If the ground mineralization is too low, automatic ground balance may fail to work. Try manual ground balance in such a case.

3. You can test the accuracy of the ground balance with the pinpoint mode. After ground balancing, if you receive no sound or a weak one when you move the search coil closer to the ground in the pinpoint mode, then the ground balance is successful. If the sound gets louder when you move the search coil closer to the ground, then the ground balance is not successful. In this case, simply change your location. If ground balance is not possible despite these efforts, you should continue your search without performing ground balance.

In order to search without ground balancing, restart the device . If you hear a sound when you swing the search coil over the ground, switch the device to DISC.1 or DISC.2 mode, adjust the ID Filter enough to eliminate the sound and start searching. Since the ID Filter is not active in the ALL METAL mode, you cannot perform a search if you can't reduce the sound.

4. Once the ground balance is set, it will remain satisfactory for a long time in most areas. However, if you encounter an excavated, backfilled or geologically composite soil structure (these type of soils can be encountered frequently on gold fields), ground balance should be performed again to adapt to the varying soil structure.

5. When using the optional large coil, pump the coil more slowly and do not keep it very close to the ground.

6. In some cases where the iSAT value is set high, the device may not be able to ground balance automatically. In such a case, first lower the iSAT and after ground balancing switch it back to its previous position.

Adjustment of these four settings is critical for a noise-free and high performance operation of the device. It is possible to obtain an average performance with the default settings. However, these settings need to be adjusted in order to perform deeper searches when ground and surrounding conditions allow or to be able to perform a search under challenging conditions.

## Sensitivity, Threshold and iSAT in All Metal Mode

In the All Metal mode, search is performed with a continuous humming sound in the background, also referred to as the threshold sound. The loudness of this hum directly impacts the detection depth of smaller and deeper targets and it is adjusted by the threshold setting. If the threshold is set too high, the target signal may not be heard. On the contrary, if it is too low, you give up the depth advantage this setting offers. In other words, weak signals of smaller or deeper targets may be missed. It is recommended for average users to leave this setting at its default value and for experienced users to adjust to the highest level where they can still hear the weak target signals.

You cannot search in the All Metal mode without ground balancing. Changes that occur in the ground effect after ground balancing cause false signals or disruption in the threshold hum. iSAT adjusts the speed that the device recovers its threshold hum and eliminates the negative effects of mineralized soils. Increasing the iSAT in high mineralization will enable a more stable operation by avoiding false signals. This, however, may cause some loss in depth and it is normal.

**Not:** In high mineralization, if you receive too many false signals without disruption in the threshold hum, lower the sensitivity first before increasing the iSAT. If the false signals continue, set the sensitivity back to its original value and increase the iSAT.

If the mineralization is low, you can decrease the iSAT and sweep the coil more slowly for a deeper search.

In the All Metal mode, although the sensitivity setting seems like it is behaving similarly to the threshold, it actually causes an increase or decrease in the popping sounds and false signals. It is important to set the sensitivity setting to the highest level possible where no major popping sounds are heard. For example; if the noise level is suitable for searching and is the same at sensitivity levels 20 and 50, then 50 should be preferred. Using the factory default levels will be a good starting point until you get familiar and experienced with the device.

If the device is stable but too noisy, the threshold setting should be decreased. However, if it sounds erratic and there is too much popping and disruption in the threshold hum, first the sensitivity setting should be lowered. If the noise continues, the sensitivity should be set back to its original setting and iSAT should be adjusted.

## Sensitivity in Discrimination Modes

Since the threshold setting is not available in the discrimination modes, you can increase the depth of the device or ensure noise-free operation on different grounds only by using the sensitivity setting.

In order to adjust the sensitivity in the discrimination modes, first ground balance while the sensitivity is at its default setting. After ground balance is completed, hold the search coil still or swing over the ground at search height.

Reduce the sensitivity if device receives noise. If not (ensure that the ID FILTER is also at its default settings when checking this), increase the sensitivity gradually until there is no popping sound. If the device starts to receive noise during searching, reduce the sensitivity gradually.

## iMASK in Discrimination Modes

If the device receives a lot of false signals due to highly mineralized soil or hot rocks in the discrimination modes, first re-ground balance. If the false signals continue, lower the sensitivity and check again. In case the false signals still exist, try increasing the ID Filter value keeping in mind that ferrous metals will be eliminated and you may miss signals of smaller nuggets by doing so. Regardless of all these, if the false signals still exist, first change the sensitivity and ID Filter values back to their previous levels. Then, increase the iMask level until the false signals are eliminated.

At the maximum level of iMASK, false signals will disappear or will be minimized. However, in some cases, increasing the iMASK will result in either loss of depth or undetection of certain metals such as copper.

**NOTE:** iMask value ranges between 0-6. The factory default is 1. At "0", the iMASK feature will be inactive. If you are searching for micro jewelry or coins and the ground is not highly mineralized, setting the iMask to "0" is recommended.

## Target ID and ID Filtering

As explained before, target ID is a 2 digit number defining the target, produced by the metal detector while the search coil goes over a target. The number is shown on the display as TARGET ID.

In some cases, the device may produce multiple IDs for the same target. This may result from a couple of factors. Target orientation, depth, purity of the metal, corrosion, mineralization level of the soil etc. Direction of the search coil swing may even cause the device to generate multiple IDs.

In some cases the device may fail to provide any ID. The device needs to receive a strong and a clear signal from the target in order to provide an ID. Therefore, it may not be able to provide an ID for targets which are too deep or too small even if the device detects them.

Keep in mind that target IDs are "probable", in other words, estimated values and it would not be possible to know the properties of a buried object exactly until it is dug out.

IDs of non-ferrous metals such as copper, silver, aluminum and lead are high. Target ID range of gold is wide and may fall within the same range of metal wastes such as iron, foil, screw caps, and pull tabs. Therefore, if you are looking for gold targets, digging out some trash metals is expectable.

Some possible Target IDs and their probabilities are indicated in the table on the right:

ID	Hot Rocks	Gold under hot rocks	Iron	Gold	Silver	Brass Copper Aluminum
0-5	•••	•				
5-10	••	•				
10-20	•	••	••	•		
20-40		•••	•••	••		
40-70				•••		
70-80					•	•
80-90					•••	••
90-99	•	•			••	•••

## Target ID and ID Filtering

- Low probability but possible in tough ground conditions and rocky fields.
- Not its typical ID but high probability due to target shape and orientation in tough ground conditions.
- High probability.



**Brown Area (Target ID: 0-10):** Highly mineralized soil and positive or negative hot rocks.

**Blue Area (Target ID: 10-40):** Ferrous metals (Gold under rocks can also fall into this category. For more details, please refer to the ROCKS and SEARCHING IN ROCKY TERRAINS and METALS UNDER HOT ROCKS sections on page 21-23).

**Yellow/Orange Area (Target ID:40-70):** Mostly gold, folio, soda cans, pull-tabs, some coins etc.

**Red Area (Target ID:70-99):** Copper, brass, aluminum, silver, some coins etc.

Above data may vary according to the field conditions.

It may take some time and experience to utilize the Target ID feature in your search area because Target IDs as well as the depths the IDs are generated by different brands and models of detectors are also different.

As indicated before, ID Filter feature is the ability of the device to perform search without producing warning tones for unwanted metals. ID Filter feature is not active in the All Metal mode. ID Filter values of discrimination modes are preset. Users may modify the ID Filter values from the menu anytime.

In order to change the ID Filter value, select the ID Filter option from the menu and decrease or increase the value using the + or - buttons. Please remember that you can miss certain metals, other than the ones you want to ignore, or signals may become weaker when performing this action.

For instance, when you set the ID Filter to 40, the device will ignore all reflected signals with an ID lower than 40 and will not provide a warning tone. In the case that the ID of a gold under a rock is reflected under 40, the device will not detect the gold.

To give another example, in the case of receiving multiple IDs - let's say 35 and 55 - due to target orientation or metal property, if you filter the IDs up to 40, 35 will fall in the filtered range so the signal strength may diminish and depth may decrease.

## FREQ.SHIFT

It is the setting which enables to change the operating frequency of the device. It is used to eliminate the electromagnetic signals that the device receives from another detector which operates in the same frequency range nearby or from the surroundings. If too much noise is received when the search coil is lifted in the air, this may be caused by the surrounding electromagnetic signals or too much sensitivity. In this case, first reduce the Sensitivity. If the noise is not eliminated, you can choose to shift the frequency. The device offers 5 different frequencies. Default setting is frequency 03.

To shift the frequency, keeping the trigger pulled back, simply press the plus (+) or the minus (-) button.

**IMPORTANT!** Frequency shift may impair performance. Therefore, it is suggested that you do not shift the frequency unless it is required and operate it with the default settings.

## LED Flashlight

It is the light used for lighting the scanned area while performing search at night or dark locations. LED flashlight does not operate when the device is off. It is recommended to turn it on when necessary since its operation consumes battery charge.

Keeping the trigger pulled back, press the up button once to activate the LED flashlight. Repeat the same procedure to turn it off.

## Pinpoint

Pinpoint is to find the center or the exact location of a detected target.

**GOLD RACER** is a motion detector, in other words, you are required to move the search coil over the target or the target over the search coil in order for the device to detect the target. The pinpoint mode is a non-motion mode. The device continues to give a signal when the search coil is kept still over the target, too.

Ground balance shall be performed properly in order to ensure precision of pinpointing. It is recommended to perform ground balance again before performing pinpoint operation on changing ground structures.

In the pinpoint mode, estimated target distance information is shown on the display. In the pinpoint mode, the signal tone increases in pitch and volume as the search coil approaches the target. In this mode, the device does not discriminate or give target IDs.

## To perform pinpoint

1. After a target is detected, move the search coil aside where there is no target response and pull the trigger back.
2. Keep the trigger pulled and bring the search coil closer to the target slowly and parallel to the ground.
3. Signal sound becomes stronger and changes in pitch while getting closer to the target center and also the number indicating target distance on the display decreases.

4. Mark the position which provides the loudest sound using a tool or your foot.

5. Repeat the above procedure by changing your direction 90°. Actions to be performed from a couple of different directions will narrow the target area and provide you with the most exact details of the target position.

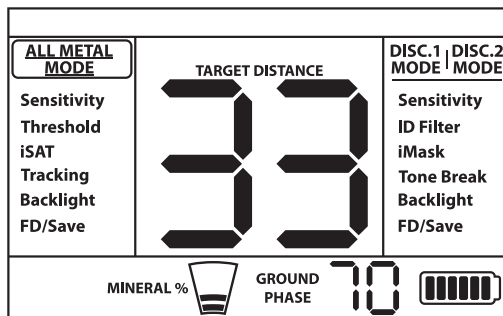
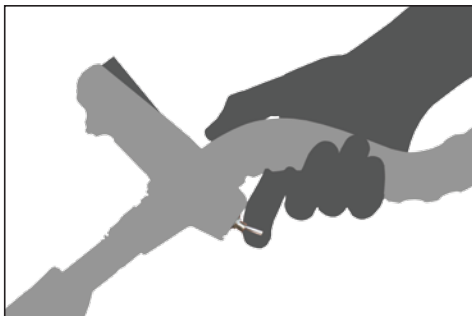

### Target Distance

The device provides an estimated target distance according to the signal strength. In the pinpoint mode, estimated target distance is shown on the display in cms (or inches - please see below for details) while getting closer to the target.

Distance detection is adjusted presuming that the target is a 2.5cm (1") coin. Actual distance varies according to the size of the target. For instance, it will indicate more distance for a target smaller than a 2.5cm (1") coin and less distance for a larger target. Pinpoint procedure is not intended for depth determination but location determination. Therefore, it is recommended that the distance indicator on the display is used for determining the proximity to the target.

**IMPORTANT!** If you want the target distance to be displayed in inches instead of cms please do the following: While the device is off, press and hold the plus (+) and minus (-) buttons simultaneously and turn the device on. "US" will be displayed. To switch back to cms, you need to turn the device off and then repeat the above procedure. While the device is initializing, "IS" will be displayed.

### Swinging Speed and Target Identification

**GOLD RACER** is a detector with very high detecting speed. When you detect a target with **GOLD RACER**, you should make wider passes instead of narrowing the sweeps and making quick sweeps over the target like in other metal detectors, in order to receive an accurate ID from the target. If your swinging speed is not correct, the device may not detect the target accurately and the target ID numbers may bounce. Also, do not tilt the coil up or down while swinging and keep it parallel to the ground.

### Large or Near-Surface Targets

Targets which are near the surface may give multiple different signals to the device. If you suspect a target near the surface, lift the search coil and swing it more slowly until a single signal is received. Also, if there is a large target near the surface it may cause an overload in the search coil and the device starts to generate a continuous sound which resembles a siren. "Saturation" message is shown on the display simultaneously. In such a case, lift the search coil up until the message disappears.

## False Signals and Reasons

Sometimes, the device may produce signals which are similar to a target signal although no metal target is present. There are various reasons for the false signals received by the device. The most known ones are ground mineralization or rocks with high mineral content, surrounding electromagnetic signals, operation of another nearby detector, rusted or corroded iron or foil in the soil, sensitivity or threshold values set too high.

Surrounding electromagnetic signals can be eliminated by reducing the sensitivity. If another detector is operating nearby, you may attempt to change the frequency or perform your search at a distance where no interference occurs. For ground mineralization or rocks with high mineral content, sensitivity, threshold set too high, please read the related sections (Ground Balance, Rocks and Searching in Rocky Terrains, Metals Under Rocks, Sensitivity, Threshold, iSAT and iMASK).

## Magnetic Mineralization Indicator

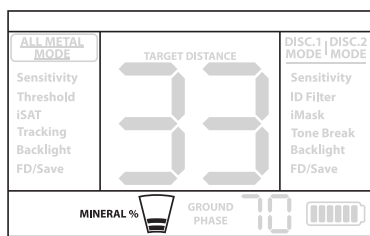

The Magnetic Mineralization Indicator consists of 5 levels. The indicator is shown empty at low mineral levels during search and at start up. In areas where the magnetic mineral level is high, the indicator level increases according to the intensity. This measurement can be summarized as the level of magnetic property and intensity of the ground. Simply, if you are working in an area which contains intense and magnetized minerals, the level will be high. If you are

working on a less intense ground, the level will be low.

This measurement is important from two aspects. First, on grounds with high magnetic mineralization, search depth is low and users should be aware of this fact. As experienced gold prospectors know, the possibility of finding gold in black sand is high. Therefore, very high values of magnetic mineralization may indicate the presence of gold. Second, magnetic mineralization is a property also found in hot rocks and measuring its level will play an important role for the device to eliminate false signals caused by hot rocks.

## Rocks and Searching in Rocky Terrains

Challenging ground conditions arise especially when conductivity and magnetic properties of the ground is too intense. Operation of the device over such ground is made possible by selecting the best operating mode and using proper ground balance, iSAT, iMASK, sensitivity and threshold settings.

Stones and rocks or cavities inside the ground are as important as the ground itself in regards to the search and target detection quality.

Soil and rocks have two different properties just like the targets you are searching for. One of them is the intensity and the other one is the conductivity - magnetic permeability ratio and these two properties are independent from each other. In this manual, the conductivity - magnetic permeability ratio will be referred to as ID in short. High magnetic permeability, low conductivity results in low ID. Soil or rocks can be highly permeable and have low or high IDs as well. If the conductivity increases relatively to magnetic permeability then the ID will also increase.



Hot rocks are classified as negative or positive based on their ID being low or high in comparison to the ID of the soil they are in. One or both of the types may be present in a field. The negative and positive effects mentioned here will only be valid if ground balancing is properly done on the existing ground. Otherwise, soil itself will not act differently from hot rocks in terms of ID. In "TRACKING" however, conditions will differ. Therefore, the effects of rocks in "TRACKING" will be discussed separately. Here we are referring to a proper ground balance without "TRACKING".

Positive rocks act just like metal and produce a metal sound. In the All Metal mode they produce a "zip zip" sound when the search coil is moved over them. If the signal is strong enough, the device may produce an ID for these rocks. Negative rocks in the All Metal mode, produce a long "boing" sound when the search coil is moved over them. The device does not give an ID for these rocks even if the signal is strong.

Positive rocks provide a typical metal sound in discrimination modes. Negative rocks do not provide a sound in discrimination modes (except for rare cases of false signals).

At higher settings of iSAT, there will be no change in the sounds of positive or negative hot rocks. As the iSAT value is decreased, the sound of positive hot rocks will remain the same but the negative hot rocks may give a thinner beep sound instead of the boing sound.

Therefore, you can make a decision by listening to the warning tones produced by the device in the field. If you receive a metal sound, it means that you either detected a positive rock or a piece of metal. If you receive a strong signal and a stable ID, you can distinguish if the detected target is a rock or metal by checking the ID. However, remember that weak signals may produce different IDs and metals under rocks may produce different metal signals. Therefore, the most appropriate action is to dig up when a metal signal is received.

Because you can encounter such a situation in gold prospecting areas where nuggets are being searched for, it is important for you to get familiar with the hot rocks and their IDs in your search field and pre-test the device with some nuggets.

If you are operating with discrimination modes and you know the ID of the surrounding rocks, you can use the ID filtering to eliminate the rocks. However, this may not be sufficient to avoid all rock signals. The device may still receive signals from rocks because soil and rocks together will form a combined effect and generate a different ID than those of rocks.

## Tracking and Effects of Rocks

When the tracking is active, the device may give a warning tone and ID when it passes over a hot rock because the effect of the rock will be different than the ground's. If you swing the search coil over the rock, tracking will automatically adjust the setting and the warning tone/ID will either disappear or diminish significantly. Because there is a slight delay in tracking, you may hear a strong signal at the first one or two swings until the setting is adjusted. Then the sound will get weaker and disappear. This will not happen with metal targets because metals will prevent the device from ground balancing. Therefore, in tracking, if you are getting a constant signal over a target after repeated swings, there is a high possibility that the target is a metal. Moving from over a rock back to soil, the device may give signals to the ground for a few swings until the ground balance setting is updated again. This is normal and should not mislead you.

Tracking is not recommended to eliminate rocks under normal conditions. It is recommended for use in areas with changing soil types.

## Metals Under Rocks

**GOLD RACER** increases the possibility of detecting metal targets under mineralized rocks through the proper adjustment of your settings. The combined effect created by the rock and metal together is lower than the effect that the metal creates by itself and the displayed ID will be different than the metal's expected ID. The displayed ID is formed by the combination of rock and metal together and gets closer to the ID of the rock if the size of the metal is smaller in relation to the rock. Keep in mind that metals under hot rocks will never appear with their own metal ID. For instance, a gold piece under a brick may produce an iron tone and ID.

Remember this very simple principle as it will save you lots of time: "If the target you detect is not a stone, it can be metal".

The key to detecting targets under mineralized rocks, particularly when positive rocks are in question, is the knowledge of the maximum ID value produced by the surrounding positive rocks. If you are performing a search in the All Metal mode, monitor the ID produced by the device. If the ID provided by your device is close to the rock and iron zone, it is quite possible that you detected a target under the rock. Since ID FILTER cannot be used in the All Metal mode, you need to discriminate by taking the value on the display into consideration.

If you filter off the rocks with a correctly adjusted ID FILTER setting in discrimination modes, you can hear the signal of the target under the rock if the target signal has a slightly greater effect than the filtered ID. The important thing here is that if you detect a target and dig out a rock, you should note the ID you got before digging and use it as the ID Filter value the next time.

For instance; the hot rocks in your search field tend to give IDs around 3-4. In this case, you should set the ID Filter to maximum 5. This way you can eliminate rocks and receive the signals of metals underneath. If you set the ID Filter too high unnecessarily, you will lose metals along with rocks.

If the hot rocks in your search area tend to give high IDs, then the chances of missing the signals of small metals underneath will be high as well.

## Messages

Warning messages are shown on the bottom of the display during search. Messages that may appear are as follows:

### Saturation

It appears on the display simultaneously with the saturation alarm sounding like a siren. This happens when the search coil overloads when it is over a shallow or a very large object. The device reverts back to normal operation if you lift the coil up. If the alarm and the message continues along a long line, you may be over a long metal such as a pipe.

In case of high mineralization, the device may overload. If the cause of overloading is not a large metal, it may be the ground itself and this situation may be overcome by lowering the sensitivity.

## Pump Coil

It appears when the trigger is pushed forward for ground balancing. Does not indicate any error or problem. It only indicates what should be done.

## Check Coil

It indicates an interruption in the search coil transmitter signal. The search coil connector may be unattached, loose or disconnected. If you own another detector with the same coil connector, please be sure that you have not attached the wrong coil by mistake. If none of the above exists, the search coil or its cable may have a defect. If the issue continues when you change the search coil, there may be an issue in the coil control circuit.

## Technical Specifications

Operating Principle	:	VLF Induction Balance
Operating Frequency	:	56 kHz
Audio Frequencies	:	2 (All Metal)
Search Modes	:	3 (All Metal/DISC.1/DISC.2)
Ground Balance	:	Automatic / Manual / Tracking
Pinpoint	:	Available
Frequency Shift	:	Available
Sensitivity Setting	:	01-99
Target ID	:	01-99
Audio Boost	:	Available
Tone Break	:	Available
Search Coil	:	26cm x 14cm (10" x 5.5") Waterproof DD
Display	:	Custom LCD
Weight	:	1.4 kg (3 lbs.) including search coil and batteries
Length	:	120cm - 140cm (47" - 55") adjustable
Battery	:	4 x AA Alkaline
Warranty	:	2 years

Makro Detectors reserves the right to change the design, specifications or accessories without notice and without any obligation or liability whatsoever.

# MAKRO

[www.makrodetector.com](http://www.makrodetector.com)  
[info@makrodetector.com](mailto:info@makrodetector.com)

---

Dealer

