

Type	
Project	
Catalog No.	

IMAGE

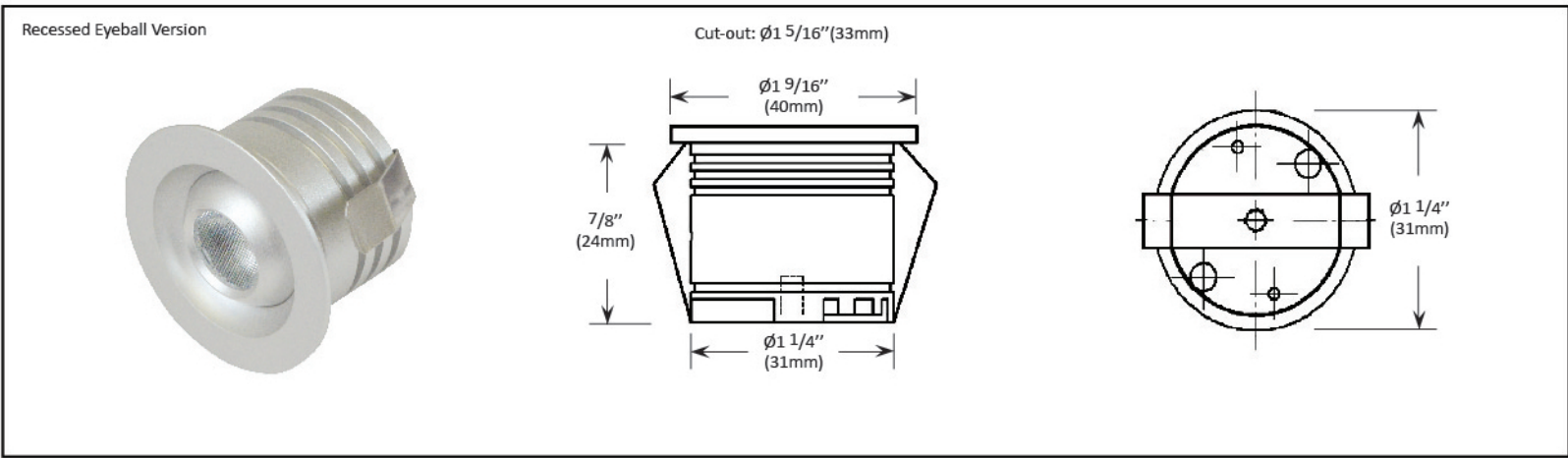

DESCRIPTION

The most versatile "Family" of miniature showcase display down lights on the market today. 5 variants of a single concept to fulfil numerous lighting tasks in tight showcase spaces.

- Small $1 \frac{9}{16}''$ (65mm) overall diameter belies a 1W powerhouse to illuminate most objects in a modern jewellery showcase (350 mA only).
- Punching far above its weight class the Morph series provide striking lighting control and impact for fixtures of their size.
- Variation in optics and glare control adds to their unmatched versatility particularly in jewellery showcases.
- Highly efficient LEDs with high CRI of 90+
- Custom colors available
- No tools required to install
- Snap together plug and play constant current system connects all fixtures in a simple system.
- All have similar outputs with different functionality

SPECIFICATIONS

LED Quantity	1
Wattage	1W@350mA / 2W@700mA
Colour Temp	2700K / 3000K / 3500K / 4000K / 5000K
Lumens	125Lm / 227Lm; 80Lm/W
Beam Angle	25° / 35° / 45°
CRI	>90
Power Factor	0.93
Lamp Life	50,000 Hrs
Environment	IP20
Certification	cULus listed
Warranty	5 years - see published warranty terms for details

* Product specifications subject to change without notice.

APPLICATIONS

- Showcase Lighting
- Retail Displays
- Exhibit Lighting
- Shelf Lighting

ORDERING INSTRUCTIONS

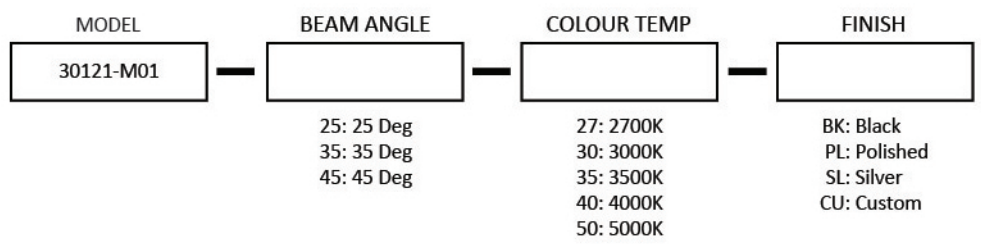

Example: 30121-M01-25-30-BK = 30121-M01, 25 degree beam angle, 3000K, black finish

Type	
Project	
Catalog No.	

WIRING DIAGRAM - For reference purposes only. Not for installation. Not to scale.

Plug and Play wiring

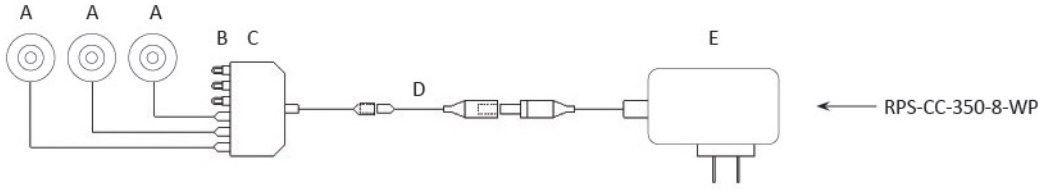

Alternate Plug and Play wiring

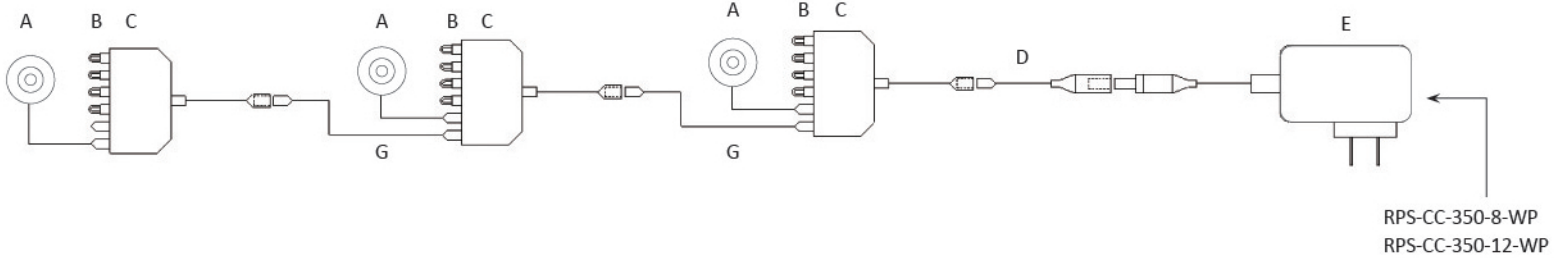

Hard-wired

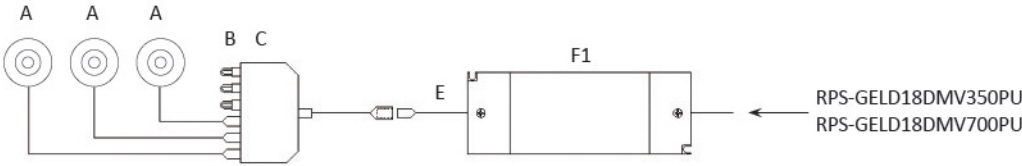

Alternate Hard-wired

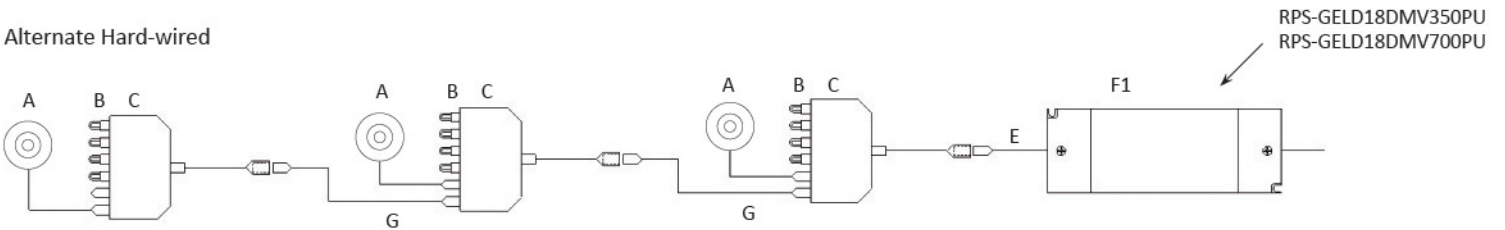

Max wiring distance between power supply and fixture is 20 feet.
Up to six fixtures can be wired to a single distribution box (CC-6SP-500)

A	30121	E	CC-100-01
B	CC-6SP-JP (Jumper)	F	Min. # fixtures = 1, Max. # fixtures = 5; Min. # fixtures = 4, Max. # fixtures = 6
C	CC-6SP-500 (5 jumpers included)	F1	Min. # fixtures = 3, Max. # fixtures = 8; Min. # fixtures = 4, Max. # fixtures = 12
D	CC-AD100-2	G	CC-1000-01, CC-1500-02

Type	
Project	
Catalog No.	

POWER SUPPLIES & ACCESSORIES

Power Supplies



RPS-CC-350-8-WP

- 350mA Constant Current
- Plug and Play power supply
- Output: 3-36VDC @ 350mA
- Wattage: 8W Max
- 6' 20 AWG output wire
- cULus Class 2, for dry use only



RPS-CC-350-12-WP

- 350mA Constant Current
- Plug and Play power supply
- Output: 3-36VDC @ 350mA
- Wattage: 12 Max. Min Load: 3W
- 30" 20 AWG output wire
- cULus Class 2, for dry use only



RPS-GELD18DM-V350PU

- 350mA Constant Current
- 18W Hard Wire Power Supply
- Dimmable with RL-DIM-DVLV-W1
- 11.93"L x 6.85"W x 6.06"H
- Input: 120-277VAC
- Output: 4-52VDC @ 350mA
- Wattage: 18 Max. Min Load: 3W
- 18 AWG output wire
- cULus Class 2, IP 67



RPS-GELD18DM-V700PU

- 700mA Constant Current
- 18W Hard Wire Power Supply
- Dimmable with RL-DIM-DVLV-W1
- 11.93"L x 6.85"W x 6.06"H
- Input: 120-277VAC
- Output: 4-26VDC @ 700mA
- Wattage: 18 Max. Min Load: 3W
- 18 AWG output wire
- cULus Class 2, IP 67

Accessories



CC-6SP-500

- 6-Port Distribution Block
- With PB input and output connector includes 5 jumpers

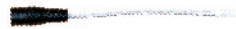

CC-AD-100-2

- 3" Adaptor Cable
- DC to PB connector



CC-1000-2

- 36" extension cable
- With PB connector
 - Extends run between fixture and distribution block



CC-6SP-JP

- Jumper for plug type B
- Must be plugged into unused slots of distribution block to complete the circuit



RL-DC-1-BK
RL-DC-1-WH

3'(1M) Power Input Extension



RL-DC-2.5-BK
RL-DC-2.5-WH

8'(2.5M) Power Input Extension



CC-100-01

PS output cable HW to PB 36"



CC-1000

36" Connecting cable with 2 PB Terminals