

LUNA FIXTURE WITH STEMS

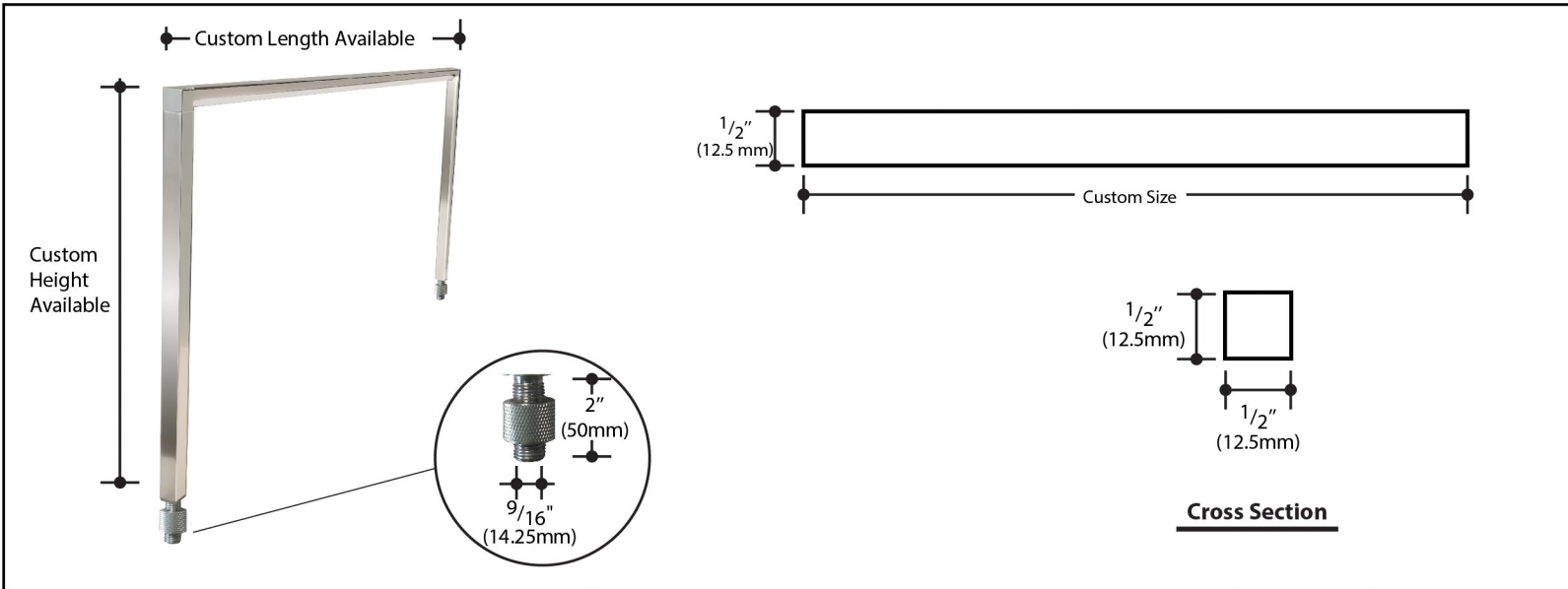

DESCRIPTION

The ultra slim series of linear lights (1/2" (12.5mm) cross section) was designed specifically for retail showcases and glass display cabinets. The slimmest series of lighting fixture profiles on the market today was intended to elegantly replace the bulky fluorescent fixtures previously used in showcase design.

The fixed beam angle at 45° illuminates a bright swath of light evenly illuminating any product. The Luna system is a high colour rendering fixture, designed for areas where even linear illumination is a design priority. Used for illuminating showcases in shops, art galleries, museums, hotel lobbies and commercial office spaces. Beam angle is fixed.

Custom sizes are available up to 96"(2.4m) and heights up to 20" (508mm) in one fixture (with 1/16" increments (1.6mm)).

FEATURES

- For interior applications such as display cabinets.
- Ultra slim 1/2" (12.5mm) cross section heat sink.
- 90° beam angle for optimum illumination in cabinets.
- Easily customised for lengths up to 96"(2.4m) and heights up to 20".
- Light Source: proprietary multi die LEDs (2700K / 3000K / 3500K / 4000K / 5000K)
- LED Driver: Revlite's 24 VDC Driver, simple 24 VDC power input
- Power consumption/ illumination options: 4W/ft, 6W/ft

SPECIFICATIONS

Input Voltage	24 VDC
Wattage	4W/ft (13W/M); 6W/ft (19W/M)
Colour Temp	2700K / 3000K / 3500K / 4000K / 5000K
Dimming	Optional
Lumen Output	110 lm/W at 4000K
CRI	90+
Beam Angle	90°
Power Factor	0.9
Lamp Life	50,000 hours
Environment	IP20
Certification	cULus
Warranty	5 years - see published warranty terms for details

* Product specifications subject to change without notice.

ORDERING INSTRUCTIONS

MODEL	LENGTH (IN)	HEIGHT (IN)	WATTAGE	COLOUR TEMP	FINISH
30600-JR-TR	Up to 96"(2.4m)*** Increments: 1/16" (1.5mm)	Up to 20" (508mm)	4: 4W/ft (13w/m) 6: 6W/ft (19w/m)	27: 2700K 30: 3000K 35: 3500K 40: 4000K 50: 5000K	BK: Black PL: Polish SL: Silver CU: Custom

Example: 30600-JR-TR-24-8-4-40-BK = 30600-JR-TR, length 24" (610mm), height 8" (203mm), 4W/ft (13w/m), 4000K, black finish

Type	
Project	
Catalog No.	

WIRING DIAGRAM - For reference purposes only. Not for installation. Not to scale.

Option #1: Plug & Play. Desktop power supply Wiring Diagram [for fixtures less than 66 1/2"(2M) long]

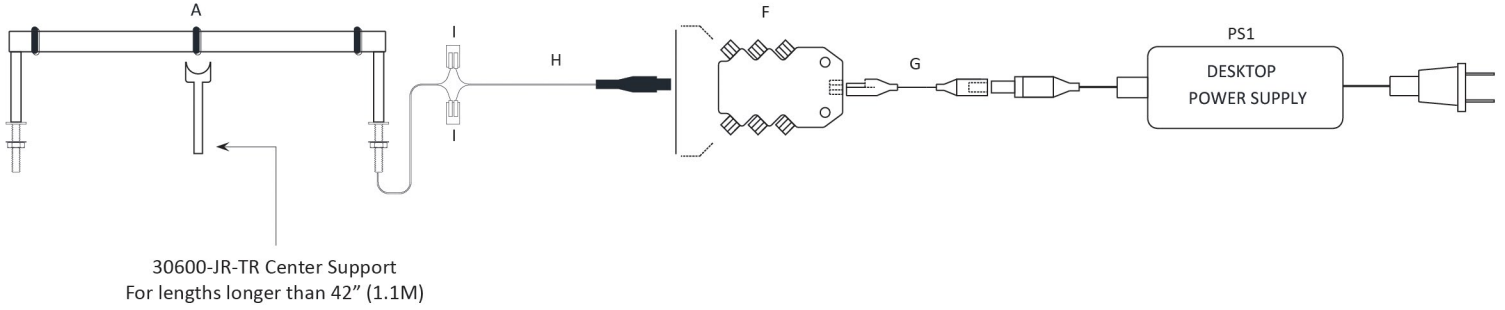

Option #1: Hardwire. Hard-Wired Wiring Diagram [for fixtures less than 66 1/2"(2M) long]

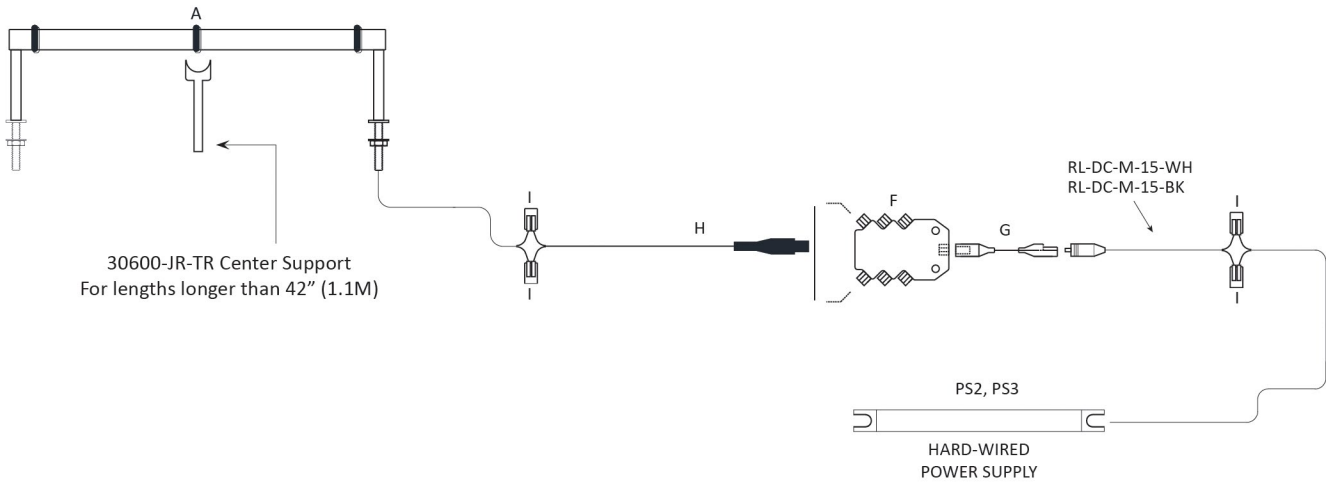

Type	
Project	
Catalog No.	

WIRING DIAGRAM - For reference purposes only. Not for installation. Not to scale.

Option #2: Plug & Play. Desktop power supply Wiring Diagram

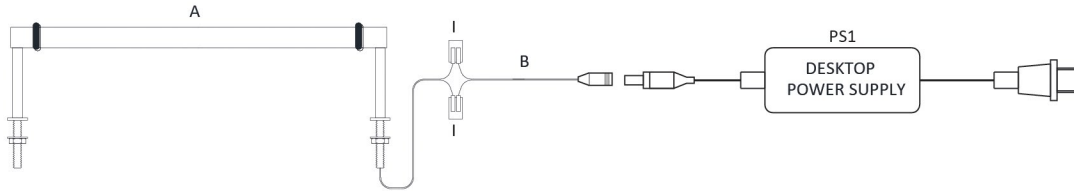

Option #2: Hardwire. Hard-Wired Wiring Diagram

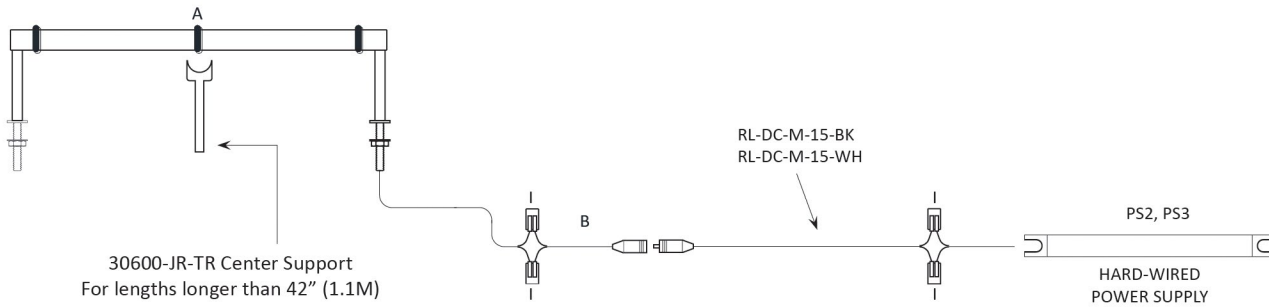

Type	
Project	
Catalog No.	

PARTS LIST

	Part#	length	Description
A	30600-JR-SPAN		Linear LED light fixture
B	RL-DC-F-15-BK	15" (380mm)	Female DC barrel connector Black / White
	RL-DC-F-15-WH	15" (380mm)	
C	RL-DC-1-BK	36" (915mm)	DC barrel connector extension Black / White
	RL-DC-1-WH	36" (915mm)	
D	RL-DC-SP-2		DC barrel connector double splitter Black / White
E	RL-DC-SP-3		DC barrel connector triple splitter Black / White
F	CV-6SP-1224		Constant voltage splitter box 6 port
G	CV-AD100-2-1224	4" (100mm)	4" Adapter harness for plug and play power supply
H	CV-75-EC-24B	3" (75mm)	3" constant voltage extension
I	221-412		Wire clamp for hardwire connection
J	RL-DC-M-15-BK	15" (380mm)	15" hardwire adapter to DC barrel connector
	RL-DC-M-15-WH	15" (380mm)	
			Max. fixture (s) length @ 6 W/ft
PS1	RPS-2424-120-240	3 ft (900mm)	
	RPS-2460-120-240	6.5 ft (2m)	
PS2	RPS-VLM60W-24	6.5 ft (2m)	
	RPS-LPV60-24	6.5 ft (2m)	
	RPS-LPV100-24	12 ft (3.65m)	
PS3	RPS-LV60-24T-1227-KK	6.5 ft (2m)	

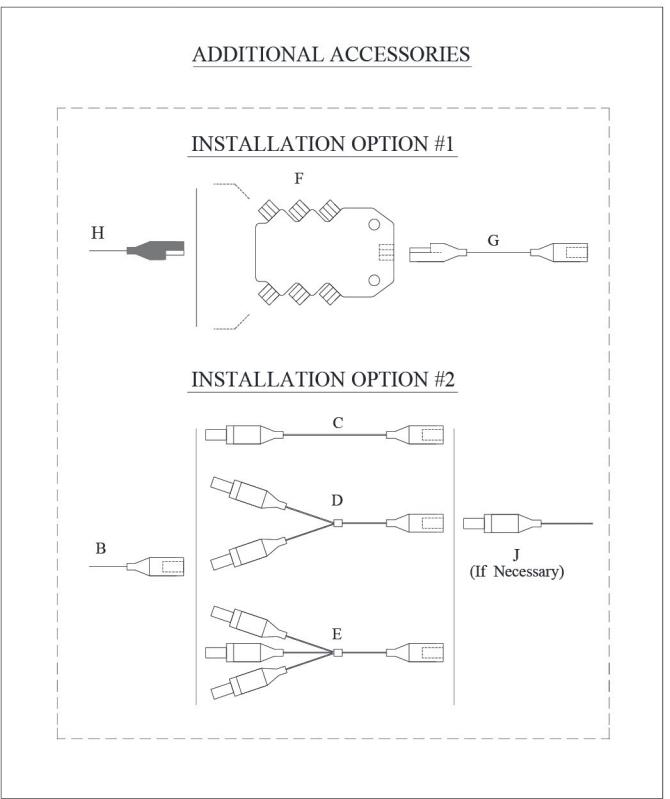

Note: Maximum fixture length is 6.5'(2m) with center support. Longer fixture lengths are shown in the chart in case customer needs to connect more than one fixture per driver.

FIXTURE WIRING ACCESSORIES - INSTALLATION OPTION #1



CV-1000-2-1224

39" (1M) extension cable with PD connectors.



CV-6SP-1224

DC 6-port constant voltage distribution box with PD in/out connector.



CV-AD100-2-1224

12VDC 3"(75mm) adapter cable DC to female PD connector.

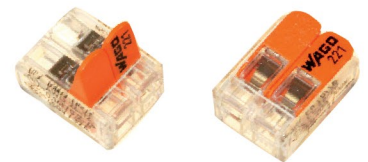

221-412

2 Conductor Lever Nut

- 28 to 12 AWG (stranded or solid)
- 600V / 20A Max
- Strip length: 3/8" (10mm)
- Operating temperature: 221 deg F
- cULus Class listed

Type	
Project	
Catalog No.	

FIXTURE WIRING ACCESSORIES - INSTALLATION OPTION #2



RL-DC-1-WH
RL-DC-1-BK
RL-DC-2.5-WH
RL-DC-2.5-BK

- 39" (1M) LED Driver Extension Cable. (RL-DC-1-BK, WH)
- 8' (2.5M) LED Driver Extension Cable. (RL-DC-2.5-BK, WH)



RL-DC-F-15-BK
RL-DC-F-15-WH

- 12" (305mm) Female 2-Wire Input Power Connector
- For connecting plug-and-play supplies to hard-wire equipment or lighting controllers



RL-DC-M-15-BK
RL-DC-M-15-WH

- 12" (305mm) Male 2-Wire Output Power Connector
- For connecting plug-and-play supplies to hard-wire equipment or lighting controllers

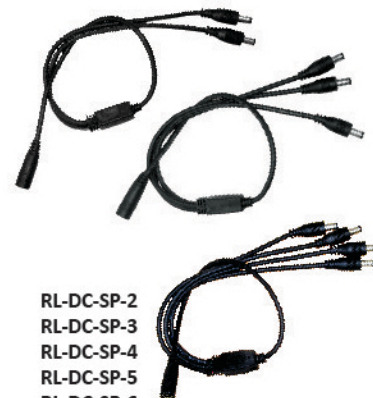

RL-DC-SP-2
RL-DC-SP-3
RL-DC-SP-4
RL-DC-SP-5
RL-DC-SP-6

- 19" (480mm) total length
- 2-Way split power feed
- 3-Way split power feed
- 4-Way split power feed
- 5-Way split power feed
- 6-Way split power feed



RPS-VLM60W-24

- Hard Wire DC Power Supply
- Non dimmable
- 5 1/4"L x 3/4"W x 3/4"H (133mm x 19mm x 19mm)
- Input / Output: 120-277VAC / 24VDC
- Wattage: 60W Max
- c-UL-us listed, Class 2



RPS-VLM100W-24

- Hard Wire DC Power Supply
- Non dimmable
- 5 3/8"L x 1.0"W x 3/4"H (137mm x 25mm x 19mm)
- Input / Output: 120-277VAC / 24VDC
- Wattage: 96W Max
- c-UL-us listed, Class 2



RPS-LPV-100-24
RPS-LPV-60-24

- Hard Wire DC Power Supply
- Non dimmable, auto reset
- 7 1/2"L x 2"W x 1 1/2"H (190mm x 51mm x 38mm)
- Input / Output: 120-264VAC / 24VDC
- Wattage: 60W Max; 100W Max
- c-UL-us listed, Class 2
- IP 67



RPS-2424-120-240

- Desktop Power Supply
- May be dimmed with RL-DIM-PWM
 - 3 1/2"L x 1 7/8"W x 1 1/4"H (89mm x 48mm x 31mm)
 - Input/Output: 100-240V AC / 24V DC
 - Wattage: 24W Max.
 - cULus listed. LPS



RPS-2460-120-240

- Desktop Power Supply
- May be dimmed with RL-DIM-PWM
 - 4 1/2"L x 2"W x 1 1/4"H (114mm x 51mm x 31mm)
 - Input/Output: 100-240V AC / 24V DC
 - Wattage: 60W Max.
 - cULus listed. LPS



RPS-2490-120-240

- Desktop Power Supply
- May be dimmed with RL-DIM-PWM
 - 5 5/8"L x 2 1/2"W x 1 1/2"H (143mm x 63mm x 38mm)
 - Input/Output: 100-240V AC / 24V DC
 - Wattage: 90W Max.
 - cULus listed. LPS.



RPS-LV60-24T-1227-KK (Dimmable)

- Hard Wire DC Power Supply
- Dimmable with RL-DIM-DVLL-W1, auto reset, Triac Dimmable
- 7 1/2"L x 2"W x 1 1/2"H (191mm x 51mm x 38mm)
- Input / Output: 120-264VAC / 24VDC
- Wattage: 60W Max
- cULus listed, Class 2
- IP 67



RPS-LV96-24T-1227-JJ (Dimmable)

- Hard Wire DC Power Supply
- Dimmable with RL-DIM-DVLL-W1 dimmer, Triac Dimmable
- Resettable
- 10"L x 3.3"W x 3"H (254mm x 86mm x 75mm)
- Input / Output: 120-277VAC / 24VDC
- Wattage: 100W Max
- cULus listed, Class 2
- Equipped with rain tight junction box rated for outdoor use