

Operation Manual

Embroidery Machine

Product Code:882-T51

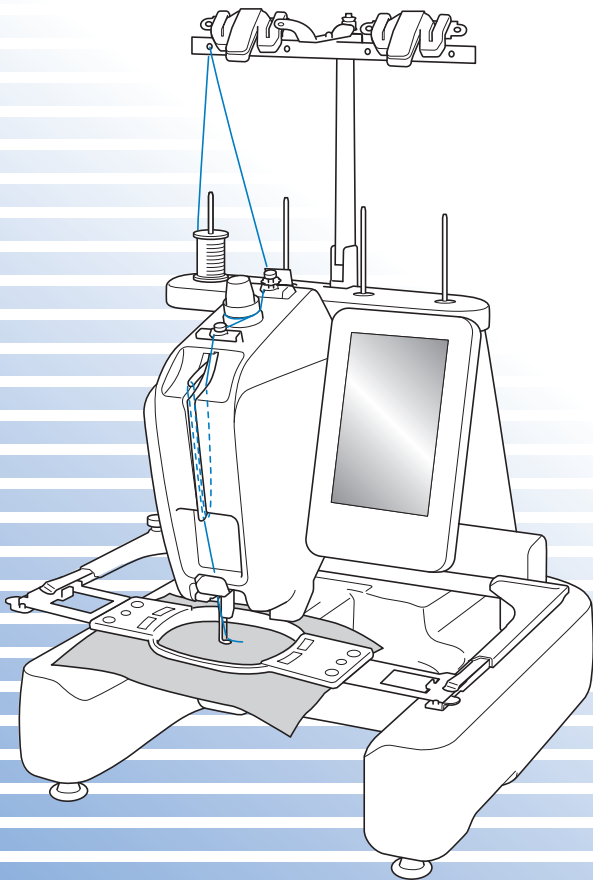

Be sure to read this document before using the machine.
We recommend that you keep this document nearby for future reference.

Introduction

Thank you for purchasing this embroidery machine. Before using this machine, carefully read the "IMPORTANT SAFETY INSTRUCTIONS", and then study this manual for the correct operation of the various functions.

In addition, after you have finished reading this manual, store it where it can quickly be accessed for future reference.

IMPORTANT SAFETY INSTRUCTIONS

Please read these safety instructions before attempting to use the machine.

⚠ DANGER - To reduce the risk of electric shock:

- 1** Always unplug the machine from the electrical outlet immediately after using, when cleaning, when making any user servicing adjustments mentioned in this manual, or if you are leaving the machine unattended.

⚠ WARNING - To reduce the risk of burns, fire, electric shock, or injury to persons:

- 2** Always unplug the machine from the electrical outlet when lubricating it or when making any other user servicing adjustments mentioned in the operation manual.
 - To unplug the machine, switch the machine to the symbol "O" position to turn it off, then grasp the plug and pull it out of the electrical outlet. Do not pull on the cord.
 - Plug the machine directly into the electrical outlet. Do not use an extension cord.
 - Always unplug your machine if the power is cut.
- 3** Electrical Hazards:
 - This machine should be connected to an AC power source within the range indicated on the rating label. Do not connect it to a DC power source or inverter. If you are not sure what kind of power source you have, contact a qualified electrician.
 - This machine is approved for use in the country of purchase only.
- 4** Never operate this machine if it has a damaged cord or plug, if it is not working properly, if it has been dropped or damaged, or water is spilled on the unit. Return the machine to the nearest authorized Brother dealer or service center for examination, repair, electrical or mechanical adjustment.
 - To avoid electric shock or fire; do not use a damaged power supply plug or loose electrical outlet, and ensure that the power supply plug is fully inserted and secure.
 - While the machine is stored or in use if you notice anything unusual, such as an odor, heat, discoloration or deformation, stop using the machine immediately and unplug the power cord.
 - When transporting the machine, be sure to lift it from the bottom positions. Lifting the machine by any other part may damage the machine or result in the machine falling, which could cause injuries.
 - When lifting the machine, be careful not to make any sudden or careless movements, otherwise you may injure your back or knees.
 - While the machine is being transported, be careful not to touch the operation panel, thread guides or any other part, otherwise injuries may result.

5 Always keep your work area clear:

- Never operate the machine with any air openings blocked. Keep ventilation openings of the machine free from the build up of lint, dust, and loose cloth.
- Do not use extension cords. Plug the machine directly into the electrical outlet.
- Never drop or insert any object into any opening.
- Keep fingers out of all machine openings, such as near the carriage, otherwise injuries may result.
- Do not operate where aerosol (spray) products are being used or where oxygen is being administered.
- Do not use the machine near a heat source, such as a stove or iron; otherwise, the machine, power cord or garment being embroidered may ignite, resulting in fire or an electric shock.
- Do not use this machine near an open flame; the movement of the embroidery frame could cause the garment being embroidered to catch fire.
- Do not place this machine on an unstable surface, such as an unsteady or slanted table, otherwise the machine may fall, resulting in injuries.

6 Special care is required when embroidering:

- Always pay close attention to the needle. Do not use bent or damaged needles.
- Keep fingers away from all moving parts. Special care is required around the machine needle.
- While the machine is in operation, keep your hands away from all the moving parts, otherwise injuries may result.
- Switch the machine to the symbol "O" position to turn it off when making any adjustments in the needle area, such as changing the needle.
- Do not use a damaged or incorrect needle plate, as it could cause the needle to break.

7 This machine is not a toy:

- Your close attention is necessary when the machine is used by or near children.
- This machine is not intended for use by young children or infirm persons without supervision.
- Young children should be supervised to ensure that they do not play with this machine.
- Do not use the included scissors or seam ripper in any other way than how they are intended. In addition, when opening a hole with the seam ripper, do not place your hands or fingers in the cutting path, otherwise injuries may result if the seam ripper slips.
- The plastic bag that this machine was supplied in should be kept out of the reach of children or disposed of. Never allow children to play with the bag due to the danger of suffocation.
- Do not use outdoors.

8 For a longer service life:

- When storing this machine, avoid direct sunlight and high humidity locations. Do not use or store the machine near a space heater, iron, halogen lamp, or other hot objects.
- Use only neutral soaps or detergents to clean the case. Benzene, thinner, and scouring powders can damage the case and machine, and should never be used.
- Always consult the operation manual when replacing or installing any assemblies, needle, or other parts to assure correct installation.

9 For repair or adjustment:

- Do not try to disassemble, repair or alter this machine in any way, otherwise a fire, electric shock or injuries may result.
- If the light unit is damaged, it must be replaced by an authorized Brother dealer.
- In the event a malfunction occurs or adjustment is required, first follow the troubleshooting table in the back of the operation manual to inspect and adjust the machine yourself. If the problem persists, please consult your local authorized Brother dealer.

Use this machine only for its intended use as described in the manual.

Use accessories recommended by the manufacturer as contained in this manual.

Use only the interface cable (USB cable) included with this machine.

The contents of this manual and specifications of this product are subject to change without notice.

For additional product information and updates, visit our website at www.brother.com

SAVE THESE INSTRUCTIONS

This machine is intended for household use.

FOR USERS IN COUNTRIES EXCEPT EUROPEAN COUNTRIES

This appliance is not intended for use by persons (including children) with reduced physical, sensory or mental capabilities, or lack of experience and knowledge, unless they have been given supervision or instruction concerning use of the appliance by a person responsible for their safety. Children should be supervised to ensure that they do not play with the appliance.

FOR USERS IN EUROPEAN COUNTRIES

This appliance can be used by children aged from 8 years and above and persons with reduced physical, sensory or mental capabilities or lack of experience and knowledge if they have been given supervision or instruction concerning use of the appliance in a safe way and understand the hazards involved. Children shall not play with the appliance. Cleaning and user maintenance shall not be made by children without supervision.

FOR USERS IN THE UK, EIRE, MALTA AND CYPRUS ONLY

IMPORTANT

- In the event of replacing the plug fuse, use a fuse approved by ASTA to BS 1362, i.e. carrying the  mark, rating as marked on plug.
- Always replace the fuse cover. Never use plugs with the fuse cover omitted.
- If the available electrical outlet is not suitable for the plug supplied with this equipment, you should contact your authorized Brother dealer to obtain the correct lead.

Federal Communications Commission (FCC)

Declaration of Conformity (For USA Only)

Responsible Party: Brother International Corporation
200 Crossing Boulevard
P.O. Box 6911
Bridgewater, NJ 08807-0911 USA
TEL : (908) 704-1700

declares that the product

Product Name: Brother Embroidery Machine
Model Number: PRS100

This device complies with Part 15 of the FCC Rules. Operation is subject to the following two conditions: (1) this device may not cause harmful interference, and (2) this device must accept any interference received, including interference that may cause undesired operation.

This equipment has been tested and found to comply with the limits for a Class B digital device, pursuant to Part 15 of the FCC Rules. These limits are designed to provide reasonable protection against harmful interference in a residential installation. This equipment generates, uses, and can radiate radio frequency energy and, if not installed and used in accordance with the instructions, may cause harmful interference to radio communications. However, there is no guarantee that interference will not occur in a particular installation. If this equipment does cause harmful interference to radio or television reception, which can be determined by turning the equipment off and on, the user is encouraged to try to correct the interference by one or more of the following measures:

- Reorient or relocate the receiving antenna.
- Increase the separation between the equipment and receiver.
- Connect the equipment into an outlet on a circuit different from that to which the receiver is connected.
- Consult the authorized Brother dealer or an experienced radio/TV technician for help.
- The included interface cable should be used in order to ensure compliance with the limits for a Class B digital device.
- Changes or modifications not expressly approved by Brother Industries, Ltd. could void the user's authority to operate the equipment.

Trademarks

IMPORTANT:

READ BEFORE DOWNLOADING, COPYING, INSTALLING OR USING.

By downloading, copying, installing or using the software you agree to this license. If you do not agree to this license, do not download, install, copy or use the software.

Intel License Agreement For Open Source Computer Vision Library

Copyright © 2000, Intel Corporation, all rights reserved. Third party copyrights are property of their respective owners.

Redistribution and use in source and binary forms, with or without modification, are permitted provided that the following conditions are met:

- Redistribution's of source code must retain the above copyright notice, this list of conditions and the following disclaimer.
- Redistribution's in binary form must reproduce the above copyright notice, this list of conditions and the following disclaimer in the documentation and/or other materials provided with the distribution.
- The name of Intel Corporation may not be used to endorse or promote products derived from this software without specific prior written permission.

This software is provided by the copyright holders and contributors "as is" and any express or implied warranties, including, but not limited to, the implied warranties of merchantability and fitness for a particular purpose are disclaimed. In no event shall Intel or contributors be liable for any direct, indirect, incidental, special, exemplary, or consequential damages (including, but not limited to, procurement of substitute goods or services; loss of use, data, or profits; or business interruption) however caused and on any theory of liability, whether in contract, strict liability, or tort (including negligence or otherwise) arising in any way out of the use of this software, even if advised of the possibility of such damage.

All information provided related to future Intel products and plans is preliminary and subject to change at any time, without notice.

SD is a registered trademark or a trademark of SD-3C, LLC.

CompactFlash is a registered trademark or a trademark of Sandisk Corporation.

Memory Stick is a registered trademark or a trademark of Sony Corporation.

SmartMedia is a registered trademark or a trademark of Toshiba Corporation.

MultiMediaCard (MMC) is a registered trademark or a trademark of Infineon Technologies AG.

xD-Picture Card is a registered trademark or a trademark of Fuji Photo Film Co. Ltd.

IBM is a registered trademark or a trademark of International Business Machines Corporation.

Microsoft, Windows and Windows Vista are registered trademarks or trademarks of Microsoft Corporation.

Each company whose software title is mentioned in this manual has a Software License Agreement specific to its proprietary programs.

All other brands and product names mentioned in this manual are registered trademarks of their respective companies. However, the explanations for markings such as ® and ™ are not clearly described within the text.

Warning Labels

The following warning labels are on the machine.
Be sure to observe the precautions described in the labels.

1

	▲CAUTION	▲VORSICHT	▲ATTENTION	▲PRECAUCIÓN	▲CUIDADO
	Carriage may cause injury. Do not put hands in carriage traveling path.	Um Verletzungen mit dem Stickarm zu vermeiden, nicht die Hände in die Nähe des Stickarms halten.	Le chariot peut provoquer des blessures. Ne pas mettre les mains dans le chemin du chariot.	El carro puede provocar lesiones. No poner las manos por donde pasa el carro.	O carro de transporte pode causar ferimentos. Não coloque as mãos sobre o trilho do carro de transporte.

	▲VOORZICHTIG	▲ATTENZIONE	▲ОСТОРОЖНО!	▲注意	▲注意
	De borduurarm kan verwondingen veroorzaken. Houdt uw handen buiten bereik van de borduurarm.	Il carrello potrebbe ferirvi. Non appoggiate la mano nel percorso del carrello.	Движущаяся каретка может быть причиной травмы. Не кладите руки на пути движения каретки.	刺しゅう機のキャリッジや刺しゅう枠が動いているときに、手や物を近づけないでください。 ケガの原因になります。	在绣花机的导轨或绣花框移动时，为避免造成伤害，请不要将手或物品靠近。

2

Label locations

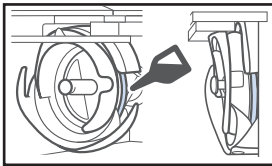

Please put a drop of oil onto the hook once a day before use.

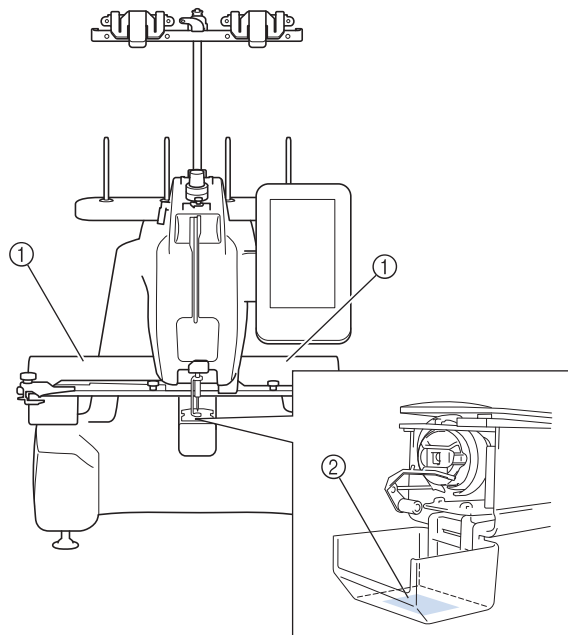

Machine Structure and Features

■ Three-dimensional materials can be embroidered

Since the embroidering surface is a cylindrical arm, three-dimensional or tubular materials such as bags and T-shirts can easily be positioned in order to sew beautiful embroidery.

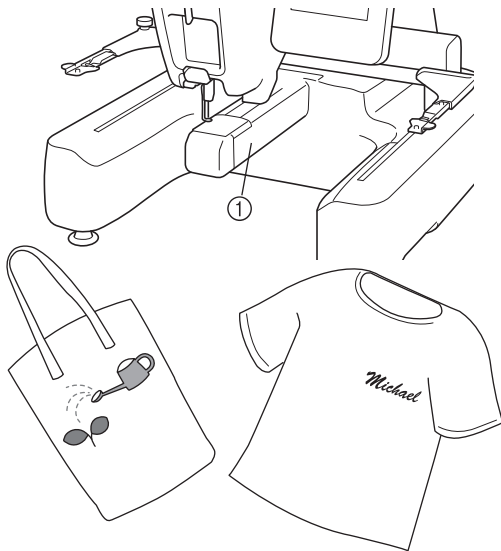

① Cylindrical arm

■ Embroider while replacing the thread spool a minimal number of times

Before starting to embroider, touch the thread color sorting key () to rearrange the embroidery order and sort it by thread colors. For example, when embroidering after simply arranging the same pattern to be repeated side-by-side, you will need to replace the thread spool multiple times with each pattern. However, by using the thread color sorting function, the thread color order will be rearranged to embroider the same color at one time, allowing you to embroider while replacing the thread spool a minimal number of times.

The thread color sorting function cannot be used with overlapping patterns.

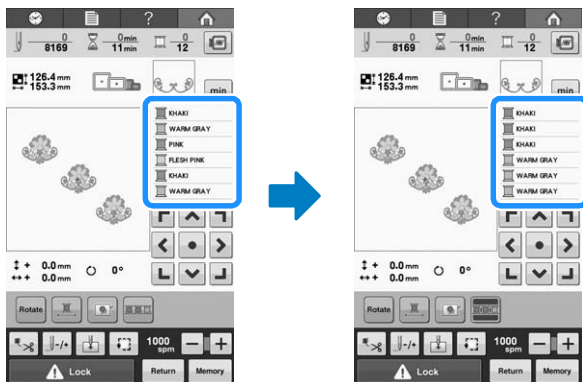

■ Insert line feeds in character patterns

While entering character embroidery patterns, touch the line feed key () to arrange the following characters on the next line.



You can check the entered characters easily by touching  .

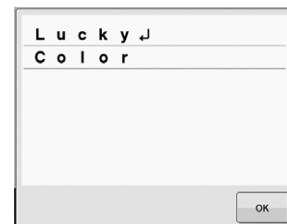

■ Four thread spools can be prepared for embroidering

Up to four thread spools can be prepared on a spool stand for the next color change. By hooking the thread on the thread cutter/holder, the thread can be smoothly replaced with that of the next color.

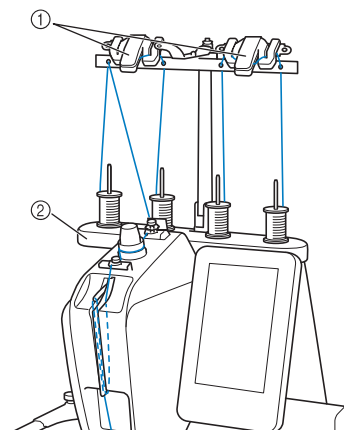

- ① Thread cutter holders
- ② Spool stand

Embroidery positioning marker

The needle drop position can be easily found with the LED pointer.

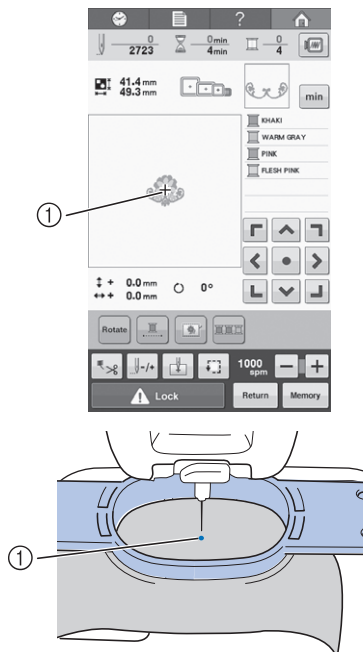

① Needle drop position

Safety mechanism

The machine is equipped with a locking mechanism that helps prevent injuries from accidental operation. The machine can only be started after the machine is unlocked. The color of the "Start/Stop" button changes to inform you of whether or not the machine is locked.

Lit in red

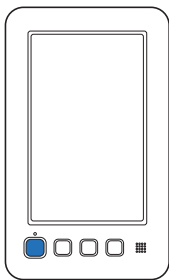

The machine is locked.

Flashing in green

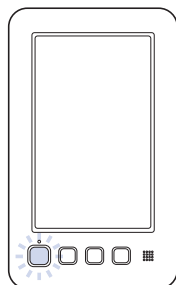

The machine can be started.

Automatic threading mechanism

Using the automatic threading mechanism, the needle can easily be threaded.

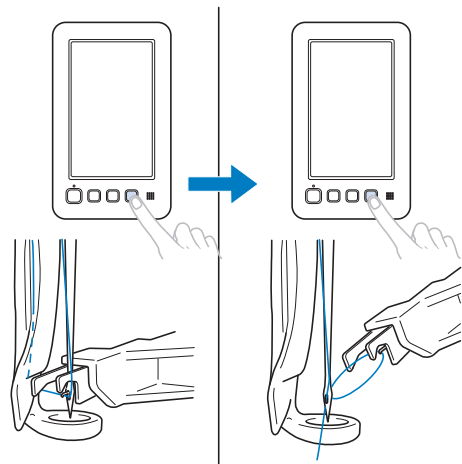

Available embroidery area

Designs with a maximum size of 200 mm (H) × 200 mm (W) (7-7/8 inches (H) × 7-7/8 inches (W)) can be embroidered. When the optional sized frames are used, you may select from many additional styles and sizes of embroidery projects.

Various built-in patterns

In addition to the many built-in character patterns, embroidery patterns and frame patterns, using optional embroidery cards greatly expands the machine's pattern library.



Embroidery pattern editing

Lettering and embroidery patterns can be combined or a text arrangement can be placed within an embroidery grouping.

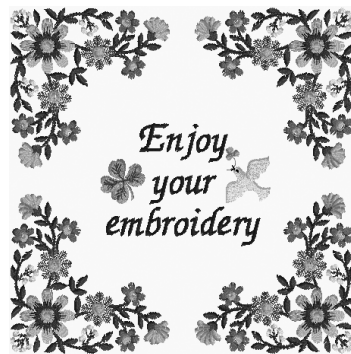

Manual Structure

This manual is constructed as described below.

Read before use

Chapter 1: Getting Ready

The setup of the embroidery machine and the various preparations required before starting to embroider are described in this chapter.

Chapter 2: Embroidering Tutorial

This chapter describes the basic embroidering operations in order—from turning on the machine and embroidering a pattern to finishing embroidering. Follow the steps of the tutorial to embroider a pattern and mastering the operations of this embroidery machine.

Chapter 3: Other Basic Procedures

This chapter provides explanations on operations other than those described in chapter 2, such as changing the needle.

Read when additional information is required

Chapter 4: Embroidering Settings

This chapter contains descriptions on the various embroidering settings, which make editing patterns simple.

Chapter 5: Selecting/Editing/Saving Patterns

This chapter provides details on selecting, editing and saving embroidery patterns.

Chapter 6: Basic Settings and Help Feature

This chapter contains descriptions on the use of the settings keys and the machines operation keys. Details on changing the basic embroidery machine settings and viewing operations on the LCD will be provided.

Chapter 7: Appendix

This chapter provides descriptions of techniques for various embroidering operations, pointers for creating beautiful embroidery, and details on maintenance procedures and corrective measures that should be taken when a problem occurs.

Searching for information

■ Searching the manual

By title

Check the descriptions at the left for the contents of each chapter, and then check the table of contents.

By keyword

Search the index at the end of this manual. Look for the desired keyword, and then refer to the page that is indicated.

By screen

Descriptions of the keys and other information that appear in the main LCD screens are provided in the tables on pages 60 to 66. For details, refer to the page that is indicated.

By condition

Various possible conditions and the corresponding operations are described on page 67. For details, refer to the page that is indicated.

■ Searching the machine

This machine is equipped with a help feature.

Learning how to perform an operation

Touch the machine operations guide key, and then check for the desired information. For details on using the machine operations guide key, refer to page 150.

Contents

Introduction	1
IMPORTANT SAFETY INSTRUCTIONS	1
Trademarks	5
Warning Labels	6
Machine Structure and Features	7
Manual Structure	9
Read before use.....	9
Read when additional information is required	9
Searching for information	9
Chapter1 GETTING READY	13
Names of Machine Parts and Their Functions	14
Front view	14
Right-side/rear view.....	15
Operation panel	15
Accessories	16
Included accessories	16
Optional accessories	17
Setting Up the Machine	18
Setup and transporting precautions.....	18
Setup location	19
Setting up the machine	20
Preparing the thread guide assembly	21
Attaching the embroidery frame holder a	21
Attaching the embroidery frame holder e	22
Chapter2 EMBROIDERING TUTORIAL	23
Operating Precautions	24
Power supply precautions	24
Needle precautions	25
Checking the needle.....	25
Bobbin precautions	26
Upper thread recommendations	26
Fabric recommendations	26
Display recommendations.....	26
Basic Procedures	27
1. Turning ON the Machine	28
Setting your machine for the first time	29
Understanding the screens	30
Screen overview	31
2. Installing the Bobbin	32
Removing the bobbin case	32
Installing the bobbin.....	33
Installing the bobbin case.....	33
Winding the bobbin	34
3. Selecting an Embroidery Pattern	37
Selecting an embroidery pattern	38
4. Editing the Embroidery Pattern	39
Continuing to the embroidering screen.....	39
5. Specifying Embroidering Setting	40
Embroidery positioning marker.....	40
6. Previewing the Image	41
Checking a preview image	41
7. Hooping the Fabric in the Embroidery Frame	42
Hooping the fabric in the embroidery frame.....	42
8. Attaching the Embroidery Frame to the Machine	44
Attaching the embroidery frame	44
9. Checking the Embroidery Area	46
10. Upper Threading	47
Changing the display of thread information	47
Upper threading	48
Threading the needle.....	51
Easily changing the thread spools	53
11. Starting Embroidering	54
Starting embroidering	54
Stopping embroidering	55
12. Checking the Thread Tension	57
13. Removing the Embroidery Frame and Fabric	58
Removing the embroidery frame.....	58
Removing the fabric.....	58
14. Turning OFF the Machine	59
Screen Quick Reference Guide	60
Key displays.....	60
Understanding the pattern type selection screen	61
Understanding the pattern list screen	62
Understanding the pattern editing screen	63
Understanding the embroidering screen	65
When You Have a Question, This May Help You	67
TECHNICAL TERMS:	67
PATTERNS:.....	67
EMBROIDERING:	67
USB connectivity	68
Chapter3 OTHER BASIC PROCEDURES	71
Changing the Needle	72
Replacing the needle	72
Correctly Using the Embroidery Frames	74
Embroidery frame types and applications.....	74
Attaching Iron-On Stabilizer (Backing) to Fabric	76
Hooping the Fabric	77
Hooping the fabric in the large embroidery frame.....	77
Hooping the compact frame and attaching to the machine.....	78
Using the embroidery sheet	79
Large/small pieces of fabric.....	80
Embroidery Frame Position and Movement	81
Changing the Embroidering Position	83
Adjusting the angle	83
If the Thread Breaks or the Bobbin Thread Runs Out While Embroidering	85
If the upper thread breaks	85
If the bobbin thread breaks or runs out	86
Embroidering From the Beginning or Middle of the Pattern	87
Resume Embroidering After Turning Off the Machine	89
Adjusting the Thread Tension	91
Adjusting the tension of the bobbin thread.....	91
Adjusting the tension of the upper thread.....	92
Chapter4 EMBROIDERING SETTINGS	95
Basting Embroidery	96
Starting Position Settings	97
Embroidering linked characters.....	97
Maximum Embroidering Speed Setting	99
Embroidery Color Management	100
Uninterrupted embroidering (monochrome - using a single color).....	100
Thread color sorting.....	100
Thread Trimming Adjustment	101
Using the automatic thread cutting function (End Color Trim)	101
Using the thread trimming function (Jump Stitch Trim).....	101
Chapter5 SELECTING/EDITING/SAVING PATTERNS	103
Using the Memory Function	104
Embroidery data precautions	104

Concerning optional embroidery cards	105
Concerning USB media	105
Selecting an Embroidery Pattern	106
General pattern selection	106
Embroidery patterns/ Decorative alphabet patterns.....	107
Frame patterns	107
Alphabet patterns	108
Embroidery cards (optional)	112
Saving embroidery patterns in the machine's memory.....	113
Saving embroidery patterns to USB media.....	114
Saving embroidery patterns in the computer	114
Retrieving patterns from the machine's memory.....	115
Recalling from USB media	116
Recalling from the computer	117
Editing the Embroidery Pattern (Pattern Editing Screen)	119
Combining patterns.....	119
Selecting the pattern to be edited	120
Displaying the enlarged pattern image	120
Moving a pattern.....	121
Flipping a pattern horizontally	121
Changing the size of a pattern	122
Rotating a pattern.....	123
Changing the text arrangement of a character	124
Changing the character spacing	124
Separating combined character patterns.....	125
Changing the thread density (only for some character and frame patterns)	126
Specifying multi-color text	126
Changing the colors of the pattern	127
Designing repeated patterns.....	128
Creating a custom thread table.....	132
Choosing a color from the custom thread table	135
Duplicating a pattern	136
Deleting a pattern	136
Editing the Embroidery Pattern (Embroidering Screen)	137
Rotating the entire pattern	137
Editing a Combined Pattern.....	138

Chapter6 BASIC SETTINGS AND HELP FEATURE 141

Using the Settings Key	142
Understanding the settings screen	142
Saving a settings screen image to USB media	144
Changing the display guides	144
Changing the thread color information.....	145
Changing the units of measurements.....	146
Changing the embroidery basting distance	146
Changing the background colors of the embroidery patterns or thumbnails.....	146
Specifying the thumbnail size	147
Specifying thread sensor	147
Changing the speaker volume	147
Selecting the "Eco Mode" or "Shutoff Support Mode"	148
Setting the opening screen	148
Changing the language	148
Turning "ON" or "OFF" the light	149
Changing the screen brightness	149
Setting the LED pointer	149
Using the Machine Operations Guide Key	150

Chapter7 APPENDIX 153

Appliqué Sewing.....	154
Sewing appliqué patterns	154
Using a frame pattern to create appliqués (1)	155
Using a frame pattern to create appliqués (2)	156
Embroidering Split Embroidery Patterns.....	157
Helpful Tips for the Operation of the Machine.....	159
Color thread table	159
Colors of Tajima (.dst) embroidery data.....	159

Creating Beautiful Embroidery.....	160
Threads	160
Stabilizers (backing)	161
Hooping techniques	162
Fabric/stabilizer compatibility chart.....	163
Maintenance	164
Cleaning the LCD	164
Cleaning the machine surface	164
Cleaning the hook	164
Cleaning around the needle plate.....	165
Cleaning the bobbin case	166
Cleaning the thread paths of the upper threads.....	166
Oiling the machine	168
About the maintenance message	169
Troubleshooting.....	170
Troubleshooting	170
Error messages.....	177
If the machine does not respond when a key is pressed.....	182
Specifications.....	183
Embroidery machine specifications	183
Upgrading Your Machine's Software	184
Upgrade procedure using USB media.....	184
Upgrade procedure using computer	185
Index.....	186

Chapter 1

GETTING READY

After unpacking the machine, first refer to “Accessories” on page 16, and check that all listed accessories are included. After checking that all accessories are included, the embroidery machine can be set up.

The setup of the machine and the various preparations required before starting to embroider are described in this chapter.

Names of Machine Parts and Their Functions	14
Front view	14
Right-side/rear view	15
Operation panel	15
Accessories	16
Included accessories	16
Optional accessories	17
Setting Up the Machine	18
Setup and transporting precautions	18
Setup location	19
Setting up the machine	20
Preparing the thread guide assembly	21
Attaching the embroidery frame holder a	21
Attaching the embroidery frame holder e	22

Names of Machine Parts and Their Functions

The names of the various parts of the machine and their functions are described below. Before using the machine, carefully read these descriptions to learn the names of the machine parts.

Front view

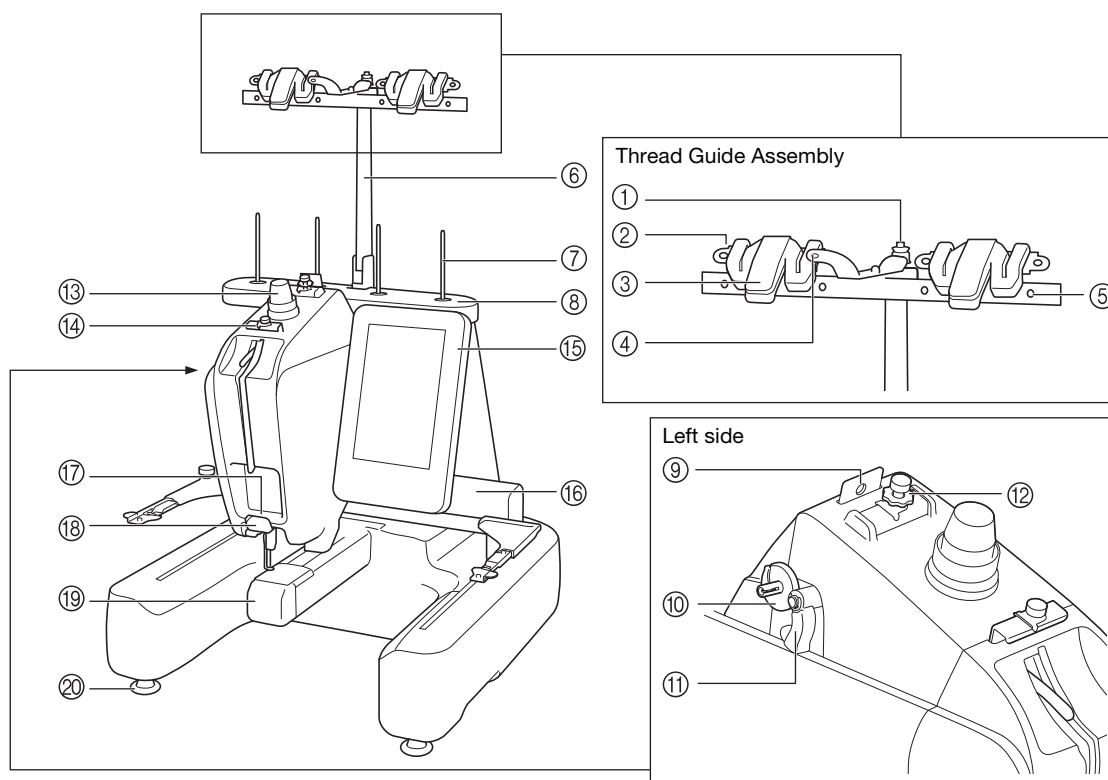

- ① **Bobbin pretension disc**
Pass the thread around the pretension disk when winding the bobbin thread. (p. 34)
- ② **Thread guide hole**
Pass the thread through thread guide hole from front side to back when winding the bobbin thread. (p. 34)
- ③ **Thread cutter/holder**
Cut the thread here when changing the upper thread. Also, you can hold the thread here when not using. (p. 53)
- ④ **Front hole in the thread guide**
Pull the thread toward you placing the thread through the guide hole from top to bottom. (p. 34)
- ⑤ **Thread guide hole**
Place the thread from back to front through the hole when winding the bobbin or threading the machine. (p. 34, 48)
- ⑥ **Thread guide assembly support**
- ⑦ **Spool pin**
- ⑧ **Spool stand**
- ⑨ **Thread guide**
Pass the thread through when threading the machine. (p. 48)
- ⑩ **Bobbin winder seat**
Set the bobbin when bobbin winding. (p. 34)
- ⑪ **Bobbin winding switch**
Set to the left to start bobbin winding. (p. 34)
- ⑫ **Upper thread guide pretension knob**
Adjust the tension of the thread. (p. 57)
- ⑬ **Thread tension knob**
Adjust the tension of the thread. (p. 57)
- ⑭ **Upper thread guide**
Pass the thread through when threading the machine. (p. 48)
- ⑮ **Operation panel**
- ⑯ **Carriage**
Attach the embroidery frame holder to the carriage. When the machine is turned on or when the machine is embroidering, the carriage moves forward, backward, left and right.
- ⑰ **Lower thread guide**
Pass the thread through when threading the machine. (p. 48)
- ⑱ **Thread cutter**
Cuts and holds the thread for needle threading. (p. 48)
- ⑲ **Hook cover/Hook**
Open the hook cover, and then insert the bobbin case into the hook.
- ⑳ **Feet**
Use the feet to level and adjust the height of the machine.



Note

- Circled numbers on the “Thread Guide Assembly” indicate the thread path for winding the bobbin.

Right-side/rear view

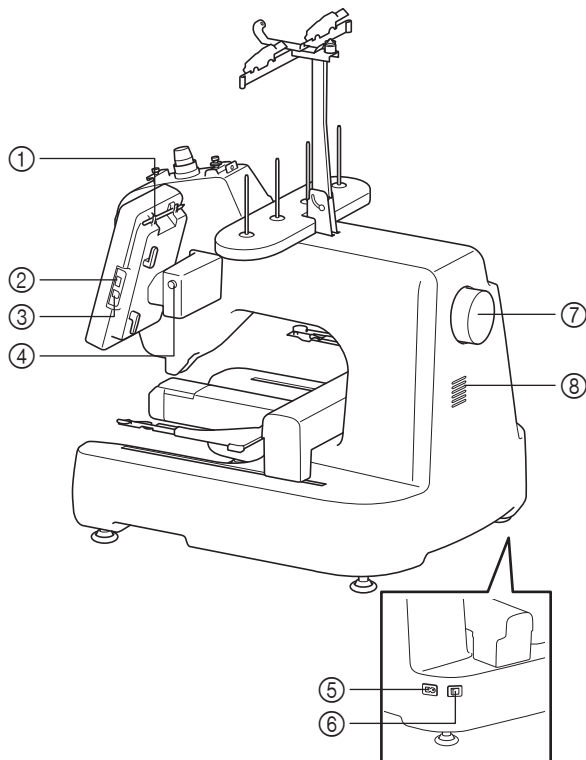

- ① **Touch pen holder**
Use the touch pen holder to hold the touch pen when not in use.
- ② **USB port (USB 2.0)**
In order to send patterns from/to USB media, plug the USB media directly into the USB port. (p. 112)
- ③ **USB port for computer**
In order to import/export patterns between a computer and the machine, plug the USB cable into the USB port.
- ④ **LCD Panel angle button**
Press to change the angle of the operation panel. Do not change the angle without pressing this button.
- ⑤ **Power supply plug**
Insert the plug on the power supply cord into the power supply plug.
- ⑥ **Main power switch**
Use the main power switch to turn the machine ON (I) and OFF (O). Do not turn the power on soon after turning the power off. It is recommended that you wait 5 seconds before turning the power back on.
- ⑦ **Handwheel**
Rotate the handwheel to move the needle up and down. Be sure to rotate the handwheel toward the operation panel (counterclockwise).
- ⑧ **Air vent**
The air vent allows the air surrounding the motor to circulate. Do not cover the air vent while the embroidery machine is being used.

Operation panel

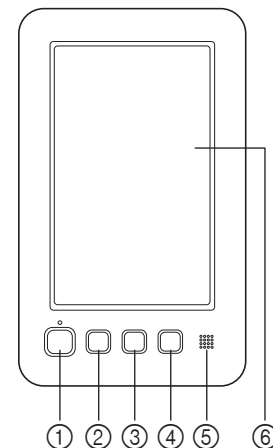

- ① **“Start/Stop” button**
Press the “Start/Stop” button to start or stop the machine. The lighting status and color of the button changes depending on the operation condition of the machine.

Lit in red	:	When the machine cannot start embroidering
Flashing in green	:	When the machine can start embroidering
Lit in green	:	While the machine is embroidering
Off	:	When the machine is turned off
- ② **Needle position button**
Press the needle position button to raise or lower the needle position. Pressing the button twice embroiders one stitch.
- ③ **Thread trimming button**
Press the thread trimming button to trim both the upper and the bobbin threads.
- ④ **“Automatic Threading” button**
Press the automatic needle threading button to thread the needle.
- ⑤ **Speaker**
- ⑥ **LCD (touch panel)**
Touch the keys that appear on the touch panel to select and edit patterns and confirm various information.

Accessories



The accessories listed below are included with this machine. Make sure to use the accessories designed for this machine.

Included accessories

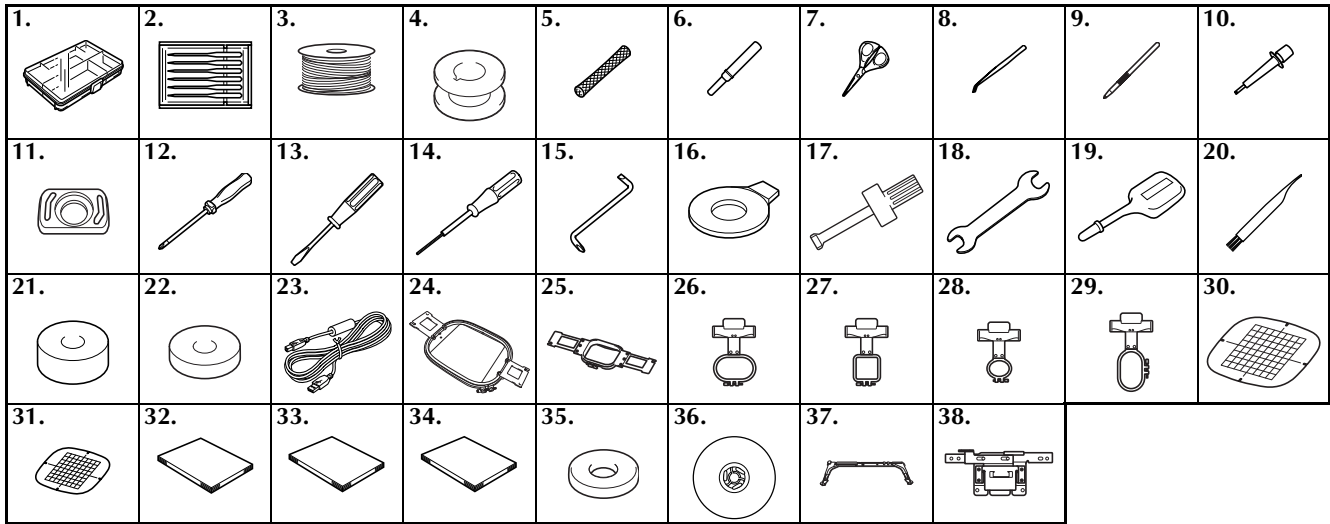
After opening the box, check that the following accessories are included. If any item is missing or damaged, contact your authorized Brother dealer.



No.	Part Name	Part Code
1	Accessory case	XC6482-051
2	Needle set	XC6469-001
3	Prewound bobbin × 5	XC6368-051
4	Metal bobbin × 3	100376-053
5	Spool net × 4	S34455-000
6	Seam ripper	XF4967-001
7	Scissors	XF2052-001
8	Tweezers	XC6542-051
9	Touch pen	XA9940-051
10	Needle changing tool (Threader)	XF2212-001
11	Needle plate spacer	XC6499-151
12	Phillips screwdriver	XC6543-051
13	Standard screwdriver	X55468-051
14	Allen screwdriver	XC5159-051
15	Offset screwdriver	XC6545-051
16	Disc-shaped screwdriver	XC1074-051
17	Screwdriver (large)	XC4237-021
18	Wrench 13 × 10	XC6159-051
19	Oiler	XZ0206-051
20	Cleaning brush	X59476-051
21	Weight (L)	XC5974-151
22	Weight (S)	XC6631-051
23	USB cable	XD1851-051
24	Embroidery frame (extra large) 200 mm (H) × 200 mm (W) (7-7/8 inches (H) × 7-7/8 inches (W))	PRSTH200 (Americas) VRTF200: XG3182-001 (Other area)

No.	Part Name	Part Code
25	Embroidery frame (medium) 100 mm (H) × 100 mm (W) (4 inches (H) × 4 inches (W))	PRH100 (Americas) PRH100: XC6286-052 (Other area)
26	Compact frame (70) 41 mm (H) × 70 mm (W) (1-5/8 inches (H) × 2-3/4 inches (W))	PRSH70 (Americas) VRSF70: XG3203-001 (Other area)
27	Compact frame (50) 50 mm (H) × 50 mm (W) (2 inches (H) × 2 inches (W))	PRSH50 (Americas) VRSF50: XG3189-001 (Other area)
28	Compact frame (44) 38 mm (H) × 44 mm (W) (1-1/2 inches (H) × 1-3/4 inches (W))	PRSH44 (Americas) VRSF44: XG3186-001 (Other area)
29	Compact frame (Portrait orientation) 33 mm (H) × 75 mm (W) (1-5/16 inches (H) × 2-15/16 inches (W))	PRSHV (Americas) VRSFV: XG3191-001 (Other area)
30	Embroidery sheet (extra large) 200 mm (H) × 200 mm (W) (7-7/8 inches (H) × 7-7/8 inches (W))	XE7171-001
31	Embroidery sheet (medium) 100 mm (H) × 100 mm (W) (4 inches (H) × 4 inches (W))	XC5759-051
32	Operation manual	This manual
33	Quick reference guide	XG1498-001
34	Embroidery design guide	XG1506-001
35	Spool mat × 4	XC7134-051
36	Spool cap × 4	130012-054
37	 Embroidery frame holder a	XG1546-001
38	 Embroidery frame holder e	XG2408-001

 **Memo**

- The included touch pen can be stored in the touch pen holder on the back of the operation panel. Refer to page 15.

Optional accessories

The following are available as optional accessories to be purchased separately from your authorized Brother dealer.

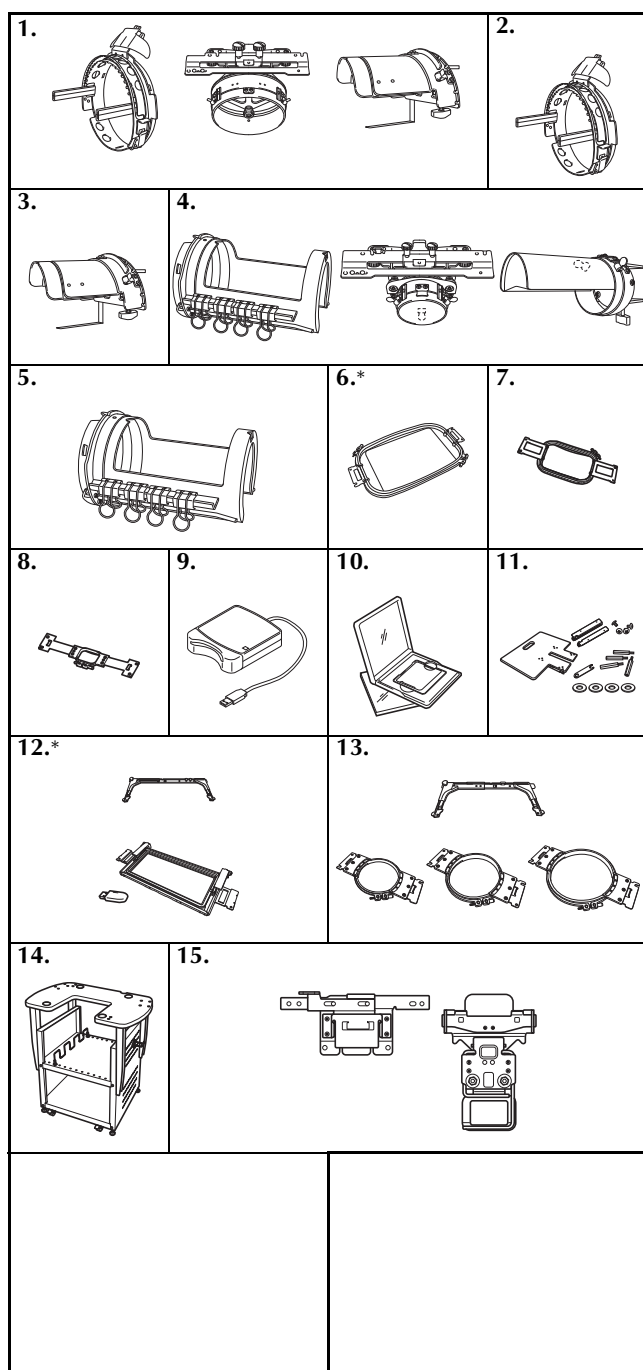

No.	Part Name	Part Code
1	Advanced cap frame 2 set	PRCF3 (Americas) PRCF3:XE2158-001 (Other area)

No.	Part Name	Part Code
2	Advanced cap frame 2	PRCFH3 (Americas) PRCFH3:XE2162-001 (Other area)
3	Mounting jig	PRCFJ2 (Americas) PRCFJ2:XC7611-052 (Other area)
4	Cylinder frame set	PRCL1 (Americas) PRCL1:XE2166-001 (Other area)
5	Cylinder frame	PRCLH1 (Americas) PRCLH1:XE2170-001 (Other area)
6	Flat frame 200 mm (H) × 200 mm (W) (7-7/8 inches (H) × 7-7/8 inches (W))	PRSFLH200 (Americas) VRFF200: XG3184-001 (Other area)
7	Embroidery frame (large) 130 mm (H) × 180 mm (W) (5-1/8 inches (H) × 7-1/8 inches (W))	PRH180 (Americas) PRH180: XC6285-052 (Other area)
8	Embroidery frame (small) 40 mm (H) × 60 mm (W) (1-1/2 inches (H) × 2-3/8 inches (W))	PRH60 (Americas) PRH60: XC6287-052 (Other area)
9	Embroidery card reader	SAECR1
10	Embroidery card	-
11	Wide table	PRSWT1 (Americas) VRWT1: XG3193-001 (Other area)
12	Border frame set 100 mm (H) × 180 mm (W) (4 inches (H) × 7 inches (W)) Embroidery frame holder b	PRSBH1 (Americas) VRBF180: XG3205-001 (Other area)
13	Round frame set (Ø160 mm (6 inches)) (Ø130 mm (5 inches)) (Ø100 mm (4 inches)) Embroidery frame holder c	PRSRHK1 (Americas) VRFFK1: XG3197-001 (Other area)
14	Embroidery stand	PRNSTD2 (Americas) VRPRNSTD: XG3199-001 (Other area)
15	Clamp frame	VRCLP45B (Europe): XG3195-001 (Other area)

* We recommend using the optional embroidery table when using the flat frame or border embroidery frame.

 **Note**

- Embroidery cards sold overseas are not compatible with this embroidery machine.
- Visit your nearest authorized Brother dealer for a complete listing of optional accessories and embroidery cards available for your machine.

 **Memo**

- Always use accessories recommended for this machine.
- All specifications are correct at the time of printing. Please be aware that some specifications may change without notice.

Setting Up the Machine

The procedures for setting up the machine are described below. If the machine is not set up correctly, it may shake or produce loud noises and the embroidery will not be sewn correctly. An optional embroidery stand is also available.

Setup and transporting precautions

⚠ CAUTION

- The temperature of the operating environment should be between 5 °C (40 °F) and 40 °C (104 °F). If the machine is operated in an environment that is either too cold or too hot, the machine may malfunction.
- Do not use the machine in a location where it will be exposed to direct sunlight, otherwise the machine may malfunction.
- Set up the machine with its four adjustable feet completely in contact with the desk or table, so that the machine is level.
- The machine weight is approximately 31 kg (68 lb). The transporting or setting up of the embroidery machine should be performed by two people.
- When transporting the machine, be sure to lift it from the bottom at the indicated positions by two people. Lifting the machine from any other area may damage the machine or result in the machine falling, which could cause injuries.

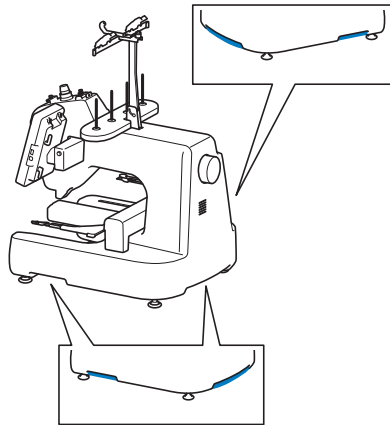

- When lightning occurs, turn off the machine and unplug the power supply cord. Lightning may cause the machine to malfunction.
- Do not plug in the power supply cord until setup of the machine is completed, otherwise injuries may result if the "Start/Stop" button is accidentally pressed and the machine starts sewing.
- When lubricating the machine, wear protective eyeglasses and gloves to prevent the oil or grease from getting into your eyes or on your skin. Do not put the oil or grease into your mouth. Keep the oil and grease out of the reach of children.

Setup location

Setup the machine in a location that meets the following requirements.

- Position machine more than 50 mm (2 inches) from the wall
- Allow sufficient space around the machine
- Place no objects within the moving range of the embroidery frame
- Set-up machine near an electrical outlet
- Use a level and stable surface, such as a desk
- Use a surface that can support the weight of the machine (about 31 kg (68 lb))
- Allow open space around the ventilation slots found on the back of the machine

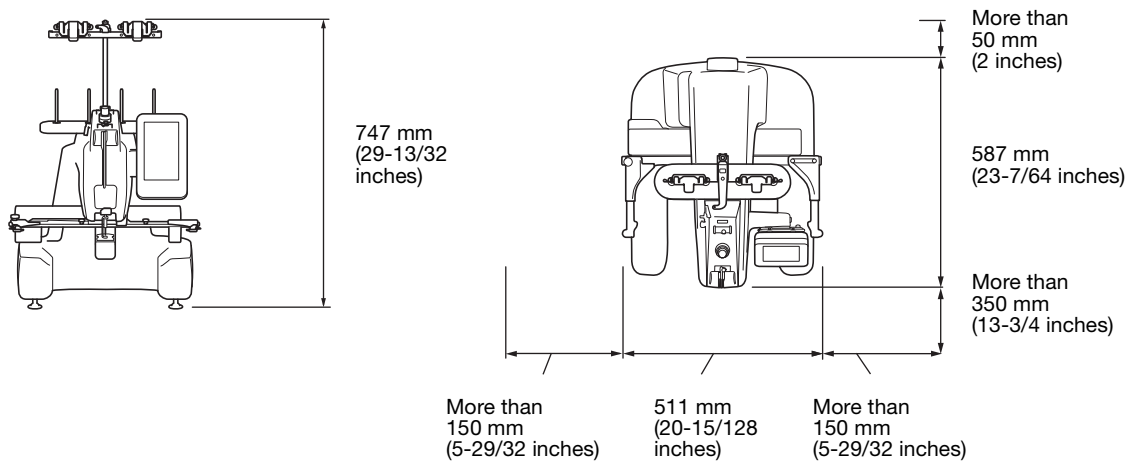

⚠ CAUTION

- In order to prevent malfunctions or damage, do not set up the machine in a location exposed to the following conditions.

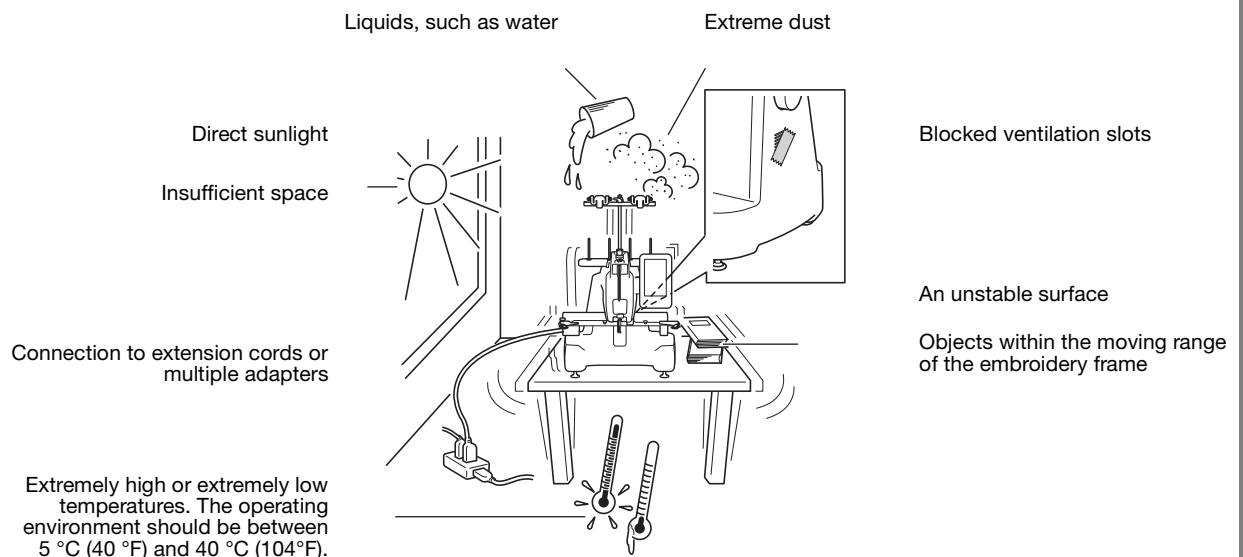

Note

- For your safety: Since the machine weighs approximately 31 kg (68 lb), do not set it up on an unstable table or desk.

Setting up the machine

When setting up the machine, adjust the legs so that the machine is steady.

- 1 Make sure that all packing tape affixed to the machine is peeled off and that all packing material is removed.
- 2 Set up the machine while making sure that there is sufficient space around it.

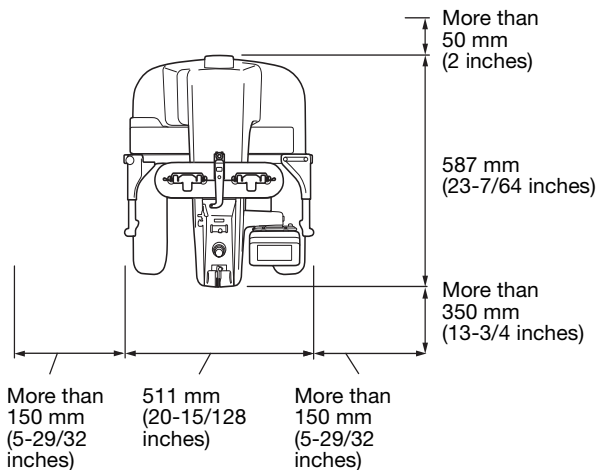

- 3 Adjust the legs so that the machine is steady.

Use the included wrench to loosen the lock nut on the leg that you wish to adjust.

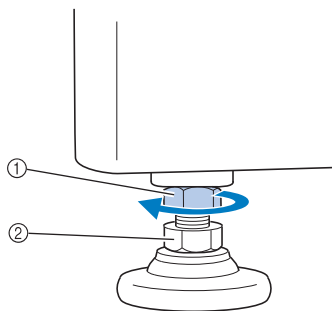

- ① Lock nut
 - ② Adjustable foot nut
- The foot can be turned.

- 4 Use the included wrench to turn the adjustable foot nut on the foot.

Turning the nut in direction ① lengthens the leg; turning the nut in direction ② shortens the leg.

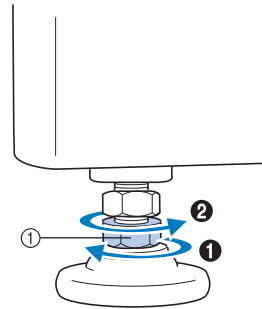

- 5 After adjusting the legs to the desired length, use the included wrench to tighten the nuts.

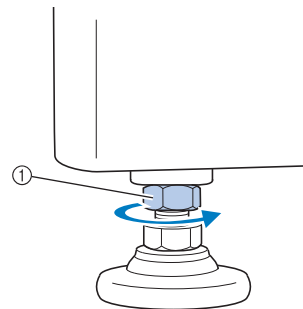

- 6 Press down on each corner of the embroidery machine to check that it is stable.

If it is still unstable, perform steps 3 through 5 again to adjust the legs.

Preparing the thread guide assembly

Assemble the thread guide assembly. Locate the included Phillips screwdriver.

- 1 Remove the two screws from the thread guide assembly support.

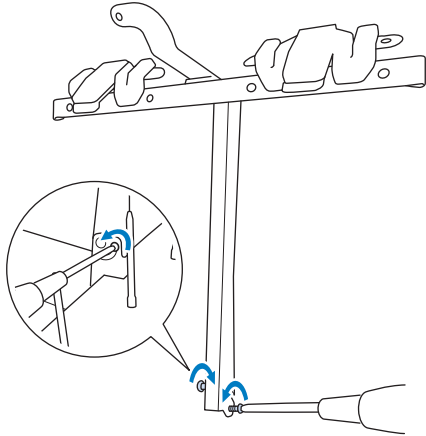

- 2 Slide the thread guide support onto the machine, and then lightly tighten the screw, until the thread guide support is secure.

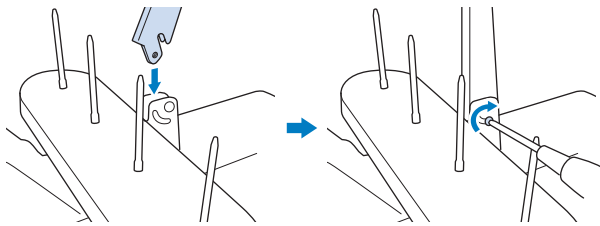

- 3 Tighten the screw on the opposite side of the thread guide assembly in the same manner.

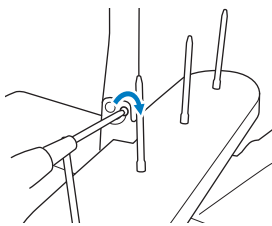

Note

- Do not apply extreme force when moving the thread guide assembly support and the thread guide.
- Be sure to tighten each screw well enough that the thread guide assembly support and the thread guide are secured.

Attaching the embroidery frame holder a

Attach the embroidery frame holder to the carriage.

- 1 Use the embroidery frame holder appropriate for the embroidery frame that you are using. (Refer to "Embroidery frame types and applications" on page 74.)
- 2 Remove the two thumb screws of the embroidery frame holder.

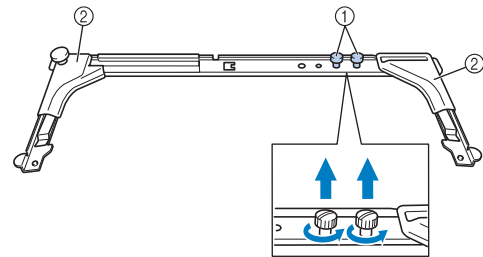

- ① Thumb screws
- ② Corner covers

- 3 Align the holes in the embroidery frame holder with the pins on the frame-mounting plate of the carriage.

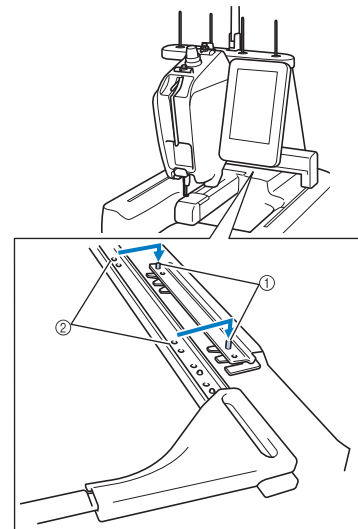

- ① Pins on the frame-mounting plate
- ② Holes in the embroidery frame holder

- 4** Secure the embroidery frame holder with the two thumb screws removed in step 2.

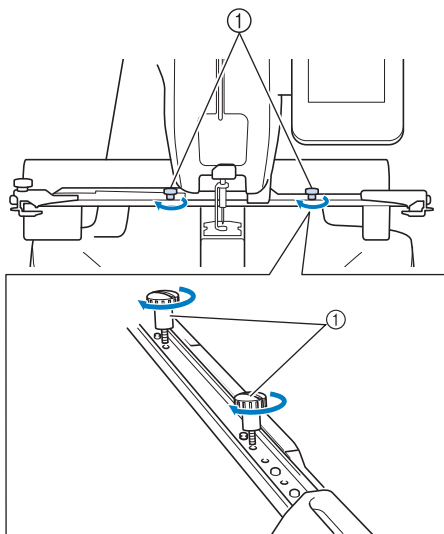

① Thumb screws



Note

- Using the disc-shaped screwdriver included, firmly tighten the thumb screws.

Attaching the embroidery frame holder e

Attach the embroidery frame holder e when using the compact frame.

- 1** Use the embroidery frame holder appropriate for the embroidery frame that you are using. (Refer to “Embroidery frame types and applications” on page 74.)
- 2** Remove the two thumb screws of the embroidery frame holder.

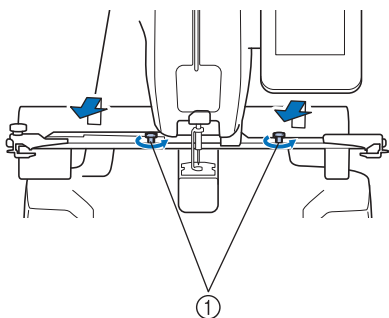

① Thumb screws

- 3** Insert the pins on the frame-mounting plate of the carriage into the holes on both sides of the mounting plate of embroidery frame holder e.

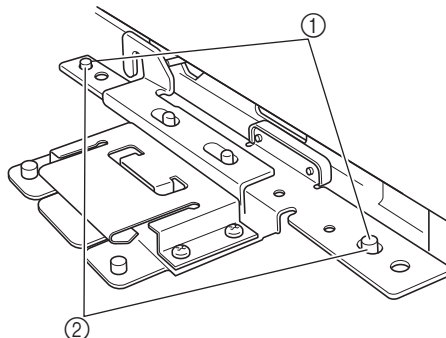

- ① Pins on the frame-mounting plate of the carriage
 ② Holes in the mounting plate of embroidery frame holder e

- 4** Install and tighten the two thumb screws removed in step 2.

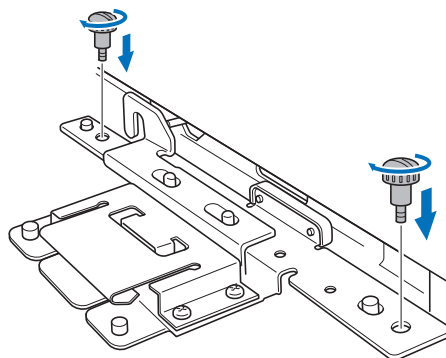

Note

- Using the disc-shaped screwdriver included, firmly tighten the thumb screws.

Chapter 2

EMBROIDERING TUTORIAL

This chapter describes the basic embroidering operations in order—from turning on the machine and embroidering a pattern to finishing embroidering. Follow the steps of the tutorial to embroider a pattern and master the operation of this embroidery machine.

Operating Precautions.....	24	11. Starting Embroidering	54
Power supply precautions	24	■ Locking mechanism.....	54
Needle precautions	25	Starting embroidering.....	54
Checking the needle.....	25	■ Continuing embroidering	55
■ Good needle.....	25	Stopping embroidering	55
■ Bad needle	25	■ Temporarily pausing	55
Bobbin precautions	26	■ Resume embroidering after the machine was turned off.....	55
Upper thread recommendations	26	■ If the thread breaks while embroidering.....	56
Fabric recommendations.....	26	12. Checking the Thread Tension	57
Display recommendations.....	26	■ Correct thread tension	57
Basic Procedures	27	13. Removing the Embroidery Frame and Fabric.....	58
1. Turning ON the Machine	28	Removing the embroidery frame	58
Setting your machine for the first time.....	29	Removing the fabric	58
Understanding the screens	30	14. Turning OFF the Machine	59
Screen overview.....	31	Screen Quick Reference Guide	60
2. Installing the Bobbin	32	Key displays.....	60
Removing the bobbin case	32	Understanding the pattern type selection screen	61
■ Oiling the machine.....	32	Understanding the pattern list screen.....	62
Installing the bobbin	33	Understanding the pattern editing screen	63
Installing the bobbin case	33	Understanding the embroidering screen	65
Winding the bobbin	34	When You Have a Question, This May Help You.....	67
3. Selecting an Embroidery Pattern	37	TECHNICAL TERMS:	67
■ Checking a preview image from the pattern list screen.....	37	■ DST.....	67
Selecting an embroidery pattern	38	■ Wiper.....	67
4. Editing the Embroidery Pattern.....	39	PATTERNS:.....	67
Continuing to the embroidering screen.....	39	EMBROIDERING:.....	67
5. Specifying Embroidering Setting.....	40	■ Customize the embroidery colors	67
Embroidery positioning marker	40	■ Resume an unfinished pattern from the last time the machine was switched off.	67
6. Previewing the Image	41	■ Getting false thread breakage error	67
Checking a preview image	41	■ Thread tension changed suddenly	67
7. Hooping the Fabric in the Embroidery Frame.....	42	■ The frame came out from the carriage.....	68
Hooping the fabric in the embroidery frame.....	42	■ Cancel the current pattern and start again.....	68
■ Embroidery frame types	42	USB connectivity.....	68
8. Attaching the Embroidery Frame to the Machine	44	■ Using USB media or embroidery card Reader/USB card writer module*	68
Attaching the embroidery frame	44	■ Connecting the machine to the computer	69
9. Checking the Embroidery Area.....	46		
10. Upper Threading	47		
Changing the display of thread information	47		
Upper threading.....	48		
Threading the needle	51		
■ Using the spool net	53		
Easily changing the thread spools.....	53		

Operating Precautions

The necessary points to ensure the correct operation of this machine are described below.

Power supply precautions

Be sure to observe the following precautions concerning the power supply.

WARNING

- Use only regular household electricity for the power source. Using other power sources may result in fire, electric shock, or damage to the machine.
- Make sure that the plugs on the power supply cord are firmly inserted into the electrical outlet and the power supply cord receptacle on the machine. Otherwise, a fire or electrical shock may result.
- Do not insert the plug on the power supply cord into an electrical outlet that is in poor condition.
- If any of the following occur, turn off the embroidery machine and unplug the power supply cord, otherwise a fire, an electric shock or damage to the machine may result.
 - When you are away from the machine.
 - After using the machine.
 - If a power outage occurs while the machine is being operated.
 - If the machine is not operating properly, for example, when there is a loose or cut connection.
 - During electrical storms.

CAUTION

- Use only the power supply cord included with this machine.
- Do not plug this machine in with extension cords or multi-plug adapters with many other appliances plugged into them, otherwise a fire or an electric shock may result.
- Do not plug in or unplug the power supply cord with wet hands, otherwise an electric shock may result.
- When unplugging the power supply cord, be sure to first turn off the machine, and then grasp the plug when unplugging the cord. Pulling on the cord may damage it or result in a fire or an electric shock.
- Do not allow the power supply cord to be cut, damaged, modified, forcefully bent, pulled, twisted, or bundled. In addition, do not place heavy objects on the cord or expose it to heat, otherwise damage to the cord, fire or an electric shock may result. If the power supply cord or its plug is damaged, stop using the machine, and then take the machine to your authorized Brother dealer for repairs before continuing use.
- If the machine is not to be used for a long period of time, unplug the power supply cord, otherwise a fire may result.
- When leaving the machine unattended, either the main switch of the machine should be turned to OFF or the plug must be removed from the socket-outlet.
- When servicing the machine or when removing covers, the machine must be unplugged.
- For U.S.A only
This appliance has a polarized plug (one blade wider than the other). To reduce the risk of electrical shock, this plug is intended to fit in a polarized outlet only one way.
If the plug does not fit fully in the outlet, reverse the plug. If it still does not fit, contact a qualified electrician to install the proper outlet. Do not modify the plug in any way.

Needle precautions

Be sure to observe the following precautions concerning the correct choice of needle for your machine.

⚠ CAUTION

- Your machine is designed to use household embroidery needles. The factory recommended needle is "HAX 130 EBBR" (Organ). Schmetz needles 130/705 H-E may be used as a substitute. Use of any other needles may break the needle or thread or damage the needle-threading mechanism or result in injuries.
- Never use bent needles. Bent needles can easily break, possibly resulting in injuries.

Checking the needle

Embroidering with a bent needle is extremely dangerous since the needle may break while the machine is operating.

Place the flat side of the needle on a flat surface and check that the distance between the needle and the flat surface is even. If the needle is bent or the tip of the needle is broken, replace the needle with a new one. (Refer to "Changing the Needle" on page 72.)

■ Good needle

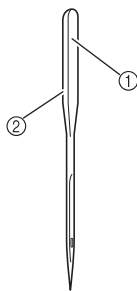

- ① Flat side
- ② Needle type marking

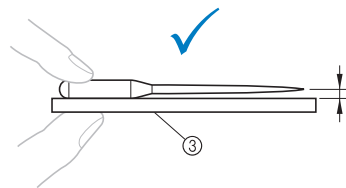

- ③ Flat surface

■ Bad needle

If the distance between the needle and the flat surface is not even, the needle is bent. Do not use a bent needle.

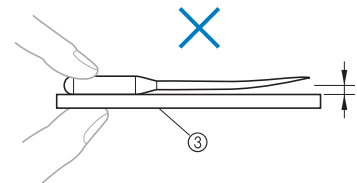

Bobbin precautions

Be sure to observe the following precautions concerning the bobbin.

CAUTION

- Only use prewound bobbin (COATS “L” type/TRU-SEW POLYESTER “Filaments”) or bobbins designed specifically for this machine. Use of any other bobbin may result in injuries or damage to the machine.
- Use a bobbin thread that has been correctly wound, otherwise the needle may break or the thread tension will be incorrect.

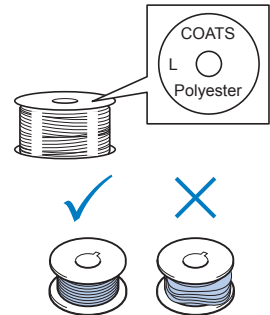

Upper thread recommendations

Be sure to observe the following recommendations concerning the upper thread.



Note

- It is recommended that rayon or polyester embroidery thread be used (120 den × 2 / 135 dtex × 2 / 40 weight (in Americas and Europe) / #50 (in Japan)).

Fabric recommendations

Be sure to observe the following recommendations concerning the fabric.



Note

- Your machine can embroider fabric that is up to 1 mm (1/16 inch) thick. If thicker fabric is sewn, the needle may bend or break.
- When embroidering overlapping stitches, it is difficult for the needle to penetrate the fabric, possibly resulting in the needle bending or breaking.
- Attach stabilizers to thin or stretch fabrics. (Refer to “Attaching Iron-On Stabilizer (Backing) to Fabric” on page 76 for information.)
- When embroidering large pieces of fabric, make sure that the fabric is not caught in the carriage.

Display recommendations

Be sure to observe the following recommendations concerning the use of the operation panel display.



Note

- Only touch the display with your finger or included touch pen. Do not use a mechanical pencil, screwdriver or any other hard or sharp object. In addition, do not apply extreme pressure to the display screen, otherwise damage to the display screen may result.

Basic Procedures

Basic embroidering procedures are described below.

Check the overall procedure below, before operating the embroidery machine.

Step	Operation	Tutorial Reference Page	Operating Procedure Reference Page
1	Turn on the machine.	p. 28	p. 24, 26
2	Install the bobbin.	p. 32	p.26
3	Select an embroidery pattern.	p. 37	
4	Edit the embroidery pattern.	p. 39	
5	Specify the embroidering settings.	p. 40	
6	Check the previewed image.	p. 41	
7	Hoop the fabric in the embroidery frame.	p. 42	p. 26
8	Attach the embroidery frame to the machine.	p. 44	
9	Check the embroidery area.	p. 46	
10	Thread the upper threads.	p. 47	p.26
11	Unlock the machine, then press the "Start/Stop" button to start embroidering. (Once embroidering is completed, the machine automatically stops.)	p. 54	
12	Check the thread tension.	p. 57	
13	Remove the embroidery frame, and then remove the fabric from the frame.	p. 58	
14	Turn off the machine.	p. 59	

The operations to embroider the pattern are described on the following pages.

Although embroidering can continue without the pattern being edited or embroidering settings being specified, refer to page 119 for details on editing the patterns, and refer to page 95 for details on specifying embroidering settings.

Descriptions of the keys and other information that appear in the main LCD screens are provided in the tables on pages 60 to 66. Use these tables for quick reference.

The various operating precautions that must be observed during the basic procedures are provided on pages 24 to 26. These precautions must be strictly observed in order for the machine to function properly. Make sure to read these precautions.

1. Turning ON the Machine

Connect the power supply cord, and then turn on the embroidery machine. For precautions concerning the power supply, refer to page 24.

- 1 Plug the power supply cord into the machine.

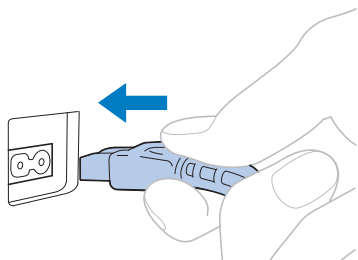

- 2 Insert the plug of the power supply cord into a household electrical outlet.

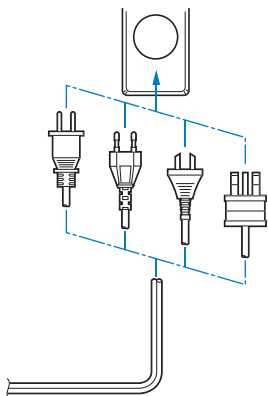

- 3 Switch on the main power switch on the back of the machine to "I".

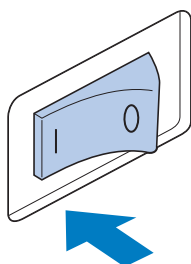

→ The LCD screen comes on.

- 4 When the machine is turned on, the opening movie is played. Touch anywhere on the screen to display the message below.

- 5 Touch .

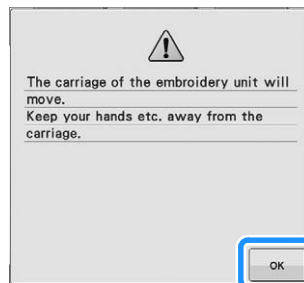

→ The pattern type selection screen appears, and the "Start/Stop" button lights up in red.

- 6 The carriage moves to its initial position.

⚠ CAUTION

- Make sure to keep your hands and other items away from the carriage, in order to prevent any injuries.

Memo

- If the machine is turned off in the middle of embroidering, the machine will automatically save the pattern position when turned on again. At that time, you will be asked if you wish to continue embroidering or begin a new operation. (Refer to "Resume Embroidering After Turning Off the Machine" on page 89.)



Setting your machine for the first time

When you first turn on the machine, set the language and time/date to your language and local time/date. Follow the procedure below when the settings screen appears automatically.

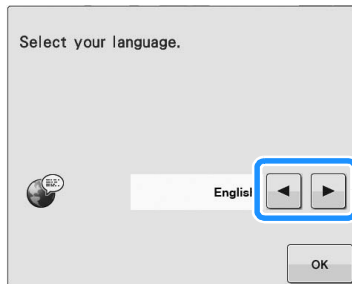
- 1 Touch  or  and to set your local language.



- 2 Touch .

- 3 The message screen, confirming if you want to set time/date, appears. To set the time/date, press ; to cancel the setting, press .

→ The screen to set time/date appears.

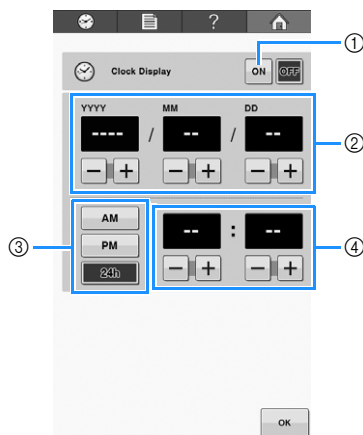

- ① Press to display the time on the screen.
- ② Set the year (YYYY), month (MM) and date (DD).
- ③ Select whether 24h or 12h setting to display.
- ④ Set the current time.

- 4 Touch  to start using your machine.







Note

- The time/date you set may be cleared, if you don't turn on the machine for an extended period of time.
- Time setting is also available by pressing  on the top left of the LCD screen.

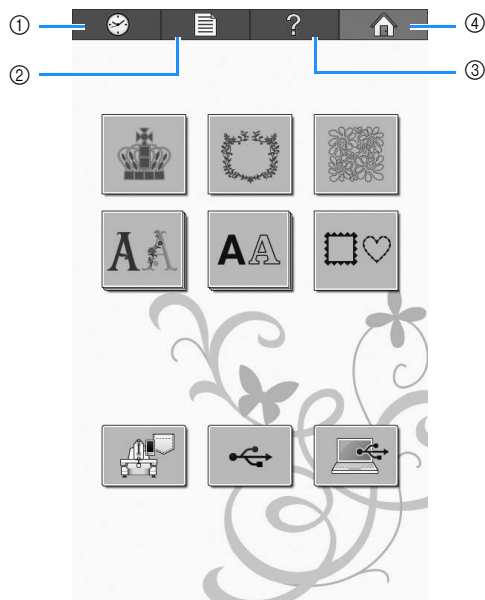
Understanding the screens

When the machine is turned on and **OK** is touched, the pattern type selection screen appears. The operations described below will be entered using the operation panel. For precautions concerning the use of the touch panel, refer to page 26.



No.	Display	Key Name	Function	Reference Page
①		Clock key	Touch this key to set the clock to your local time.	p. 29
②		Settings key	Touch this key to change the embroidery machine settings.	p. 142
③		Machine operations guide key	Touch this key to check a machine operation.	p.150
④		Home key	Touch this key to cancel all operations previously performed and return to the initial pattern type selection screen.	

* The keys in the table above appear and can be used in most of the screens described later in this manual.

Screen overview

The basic operation flow is shown below.

In the **pattern type selection screen**, select a pattern type. (Refer to page 37, 61.)

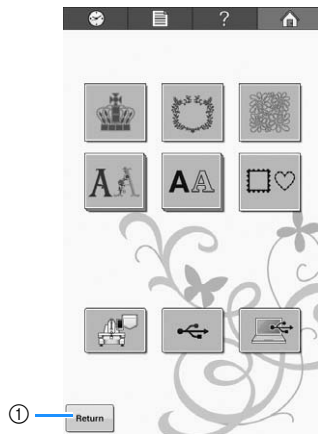

- ① Touch this key to continue to the **pattern editing screen** after at least one pattern has been selected. This key is not available unless a pattern has been previously selected.



In the **pattern list screen**, select the pattern. (Refer to page 37, 62.)

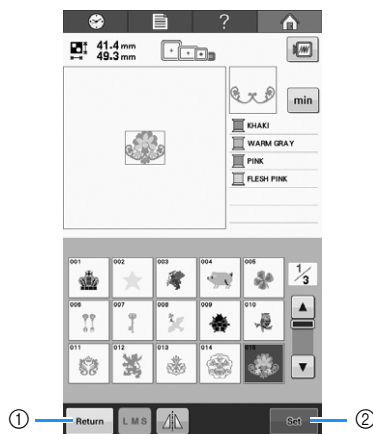

- ① Touch this key to return to the **pattern type selection screen**.
- ② Touch this key to continue to the **pattern editing screen**.



In the **pattern editing screen**, edit the pattern. (Refer to page 39, 63.)

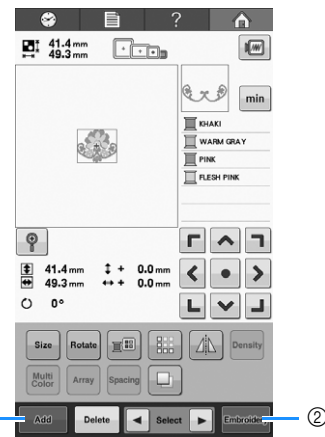

- ① Touch this key to return to the **pattern type selection screen** and add another pattern.
- ② Touch this key to continue to the **embroidering settings screen**.



In the **embroidering screen**, if it is a combined pattern, edit the entire pattern, specify the embroidering settings and check the embroidery area. And then, check the thread color order to position the upper threads. Touch  Lock to unlock the machine so that the "Start/Stop" button starts flashing in green. The embroidery machine is now ready to begin embroidering. (Refer to page 47, 65.)

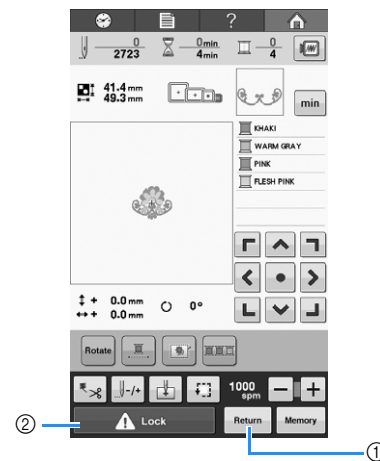

- ① Touch this key to return to the **pattern editing screen**.
- ② Unlock key

2. Installing the Bobbin

When the machine is purchased, an empty bobbin case is installed in the hook. You will need to install a bobbin wound with bobbin thread for embroidering. For precautions concerning the bobbin, refer to page 26.

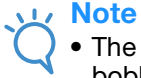

Note

- The machine does not indicate how much bobbin thread is remaining. Before starting to embroider make sure that there is enough bobbin thread for the pattern.
- Make sure to clean the bobbin case every time the bobbin is changed. For details on cleaning the bobbin case, refer to “Cleaning the bobbin case” on page 166.

Removing the bobbin case

1 Open the hook cover.

Pull the hook cover toward you.

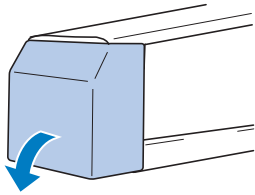

2 Pull the thread picker toward you.

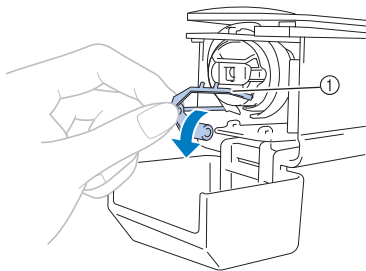

① Thread Picker

To gain access to the bobbin case easily, pull the thread picker toward front.



Memo

- Thread picker is a device that is used to hold the thread when beginning to embroider or when trimming the thread.

⚠ CAUTION

- The thread picker can only be moved within a certain range. Do not pull it with extreme force.

3 Grab the bobbin case latch, and remove the bobbin case.

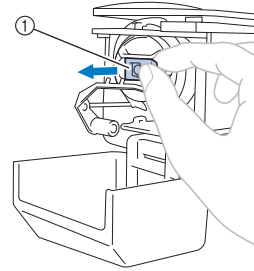

① Latch

■ Oiling the machine

After removing the bobbin case, apply oil to the machine. The race should be oiled. For details on oiling the machine, refer to “Oiling the machine” on page 168.



Note

- Put a drop of oil onto the hook once a day before use.

Installing the bobbin

- 1 Insert the bobbin into the bobbin case.

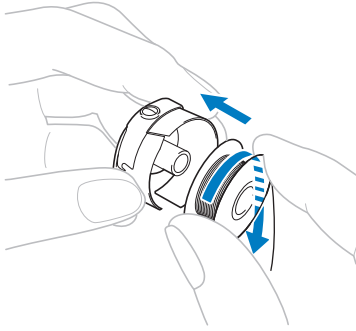

Note

- Check that the thread winds off the bobbin clockwise as shown in the illustration. If the bobbin is installed with the thread winding off in the opposite direction, the machine will not embroider correctly.

- 2 Pass the thread through the thread slit and under the tension-adjusting spring.

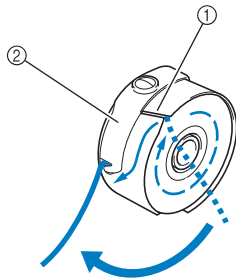

- 1 Thread slit
- 2 Tension-adjusting spring

- 3 Pull the thread about 50 mm (2 inches) through the opening in the tension-adjusting spring.

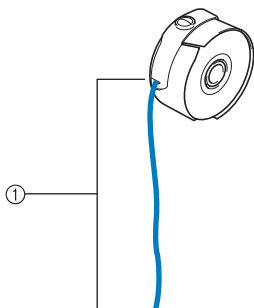

- 1 About 50 mm (2 inches).

Installing the bobbin case

- 1 Insert the bobbin case into the hook.

Insert the bobbin case while aligning the tab on the bobbin case with the notch in the hook, as shown in the illustration.

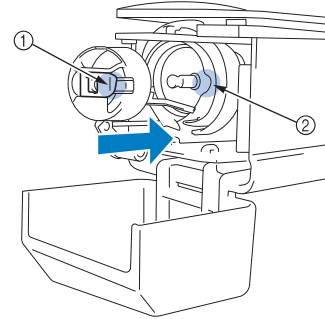

- 1 Tab
- 2 Notch

- 2 Fully insert the bobbin case until it snaps into place.

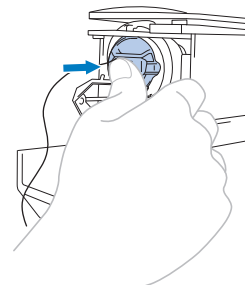

- 3 Close the hook cover.

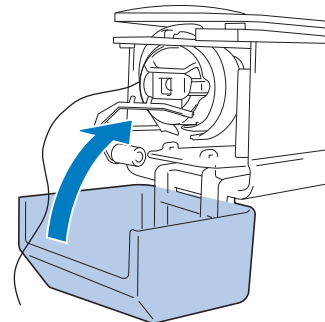

Winding the bobbin



Note

- Use the included metal bobbin when winding the bobbin with the machine.
- Circled numbers on the thread guide assembly indicate the threading path for winding the bobbin.

Prepare the metal bobbin and the spool of bobbin thread.

- 1** Turn the main power to ON.

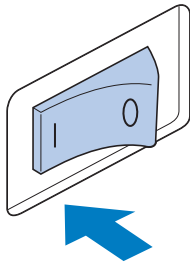

- 2** Align the groove in the bobbin with the spring on the bobbin winder shaft, and set the bobbin on the shaft.

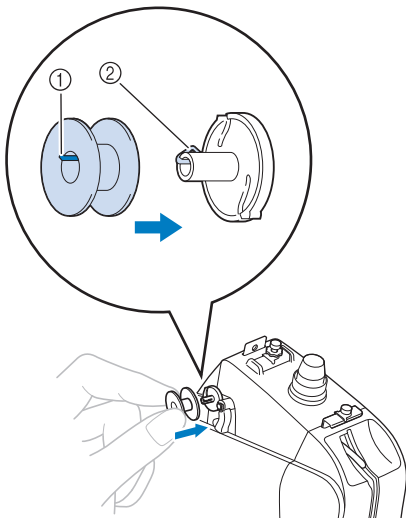

- ① Groove in the bobbin
- ② Spring on the shaft

- 3** Place the thread spool on either the first or second spool pin on the left side. Push the spool cap onto the spool pin as far as possible to secure the thread spool.

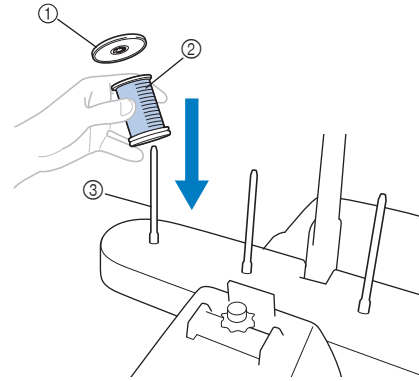

- ① Spool cap
- ② Thread spool
- ③ Spool pin

- 4** Pass the thread through the hole in the thread guide just above the spool from the back to the front.

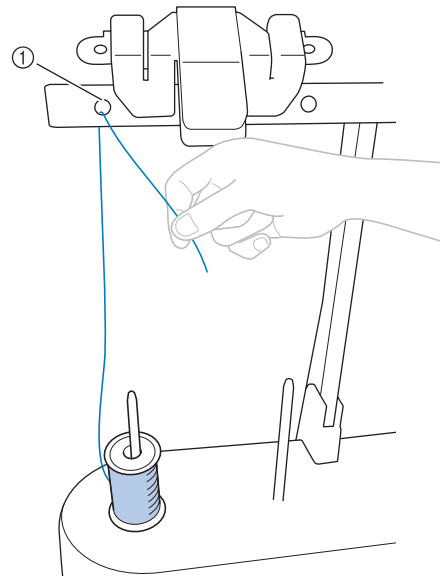

- ① Hole in the thread guide above the spool

- 5** Pass the thread through thread guide hole from front side to back.

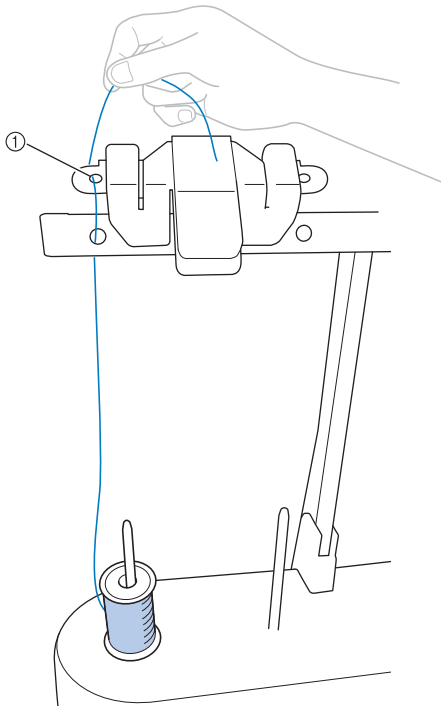

① Thread guide hole

- 6** Pass the thread around the pretension disc as shown in the illustration. Make sure that the thread is correctly fed into the tension disc.

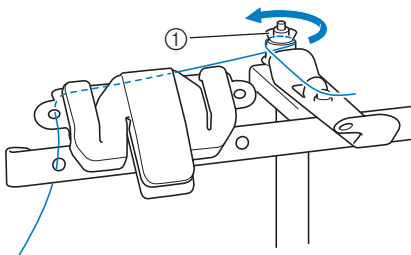

① Pretension disc

- 7** Pass the thread through the thread guide hole towards you as shown in the illustration.

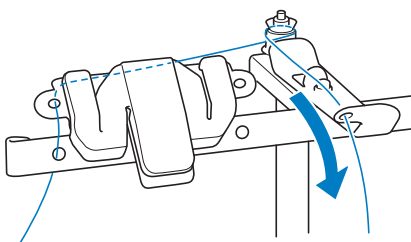

- 8** Wind the thread clockwise around the bobbin 4 or 5 times, as shown in the illustration.

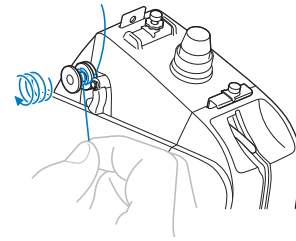

- 9** Pass the end of the thread through the guide slit on the bobbin winder seat, and pull the thread. The cutter will cut the thread.

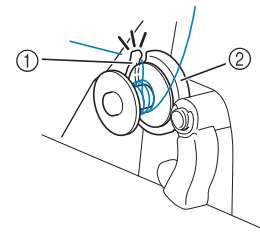

- ① Guide slit (with built-in cutter)
② Bobbin winder seat



Note

- Be sure to follow the procedure described. If the bobbin is wound without the thread being cut with the cutter, when the bobbin thread runs low, the thread may become tangled around the bobbin and cause the needle to break.

- 10** Push the bobbin winding switch to the left, until it clicks into place.

→ The bobbin winding window will be displayed on the LCD screen.

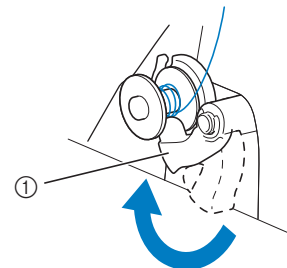



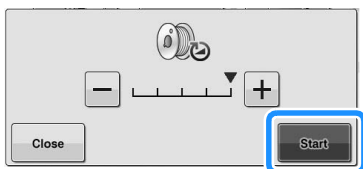

- ① Bobbin winding switch

11 Press .





→ The bobbin starts winding. The bobbin stops rotating when bobbin winding is completed. The bobbin winding switch will automatically return to its original position.



Note

-  changes to  while the bobbin is winding. Press  if you want to stop before the bobbin is fully wound.
- Stay near the machine while winding the bobbin to make sure the bobbin thread is being wound correctly. If the bobbin thread is wound incorrectly, press  immediately to stop the bobbin winding.

Memo

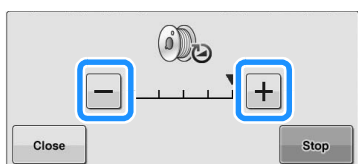
- You can change the winding speed by pressing  (to decrease) or  (to increase) in the bobbin winding window.



- Press  to minimize the bobbin winding window. Then, you can perform other operations, such as selecting a stitch or adjusting the thread tension, while the bobbin is being wound.
- Press  (in top right of the LCD screen) to display the bobbin winding window again.

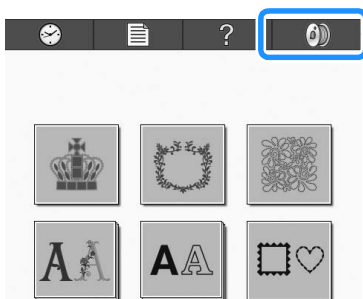

12 Cut the thread with the cutter and remove the bobbin.

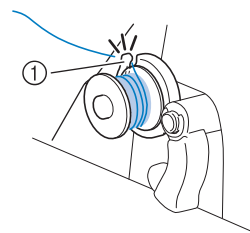



① Cutter

Note

- When removing the bobbin, do not pull on the bobbin winder seat. Doing so could loosen or remove the bobbin winder seat, and could result in damage to the machine.

CAUTION

- Check that the bobbin thread has been wound correctly, otherwise the needle may break or the thread tension will be incorrect.  
- Be sure to clean the bobbin case each time that the bobbin is changed. Thread wax and dust easily collect around the hole in the tension-adjusting spring on the bobbin case, resulting in an incorrect thread tension. For details, refer to "Cleaning the bobbin case" on page 166.
- Be sure to check the tension of the bobbin thread each time that the bobbin is changed.
- Depending on the bobbin thread type, the tension of the bobbin thread may differ. Be sure to check the tension of the bobbin thread and adjust the tension if necessary. For a metal bobbin, use both weights, large (L) and small (S). For detailed instructions on how to adjust the bobbin tension, refer to page 91.

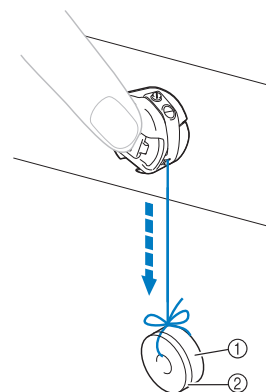

- ① Weight (L) (Part Code: XC5974-151)
- ② Weight (S) (Part Code: XC6631-051)

3. Selecting an Embroidery Pattern

As an example, we will select the pattern shown at the right.



In the pattern type selection screen, select a pattern category (type).

Pattern type selection screen (For details on the keys and other information on the screen, refer to page 61.)

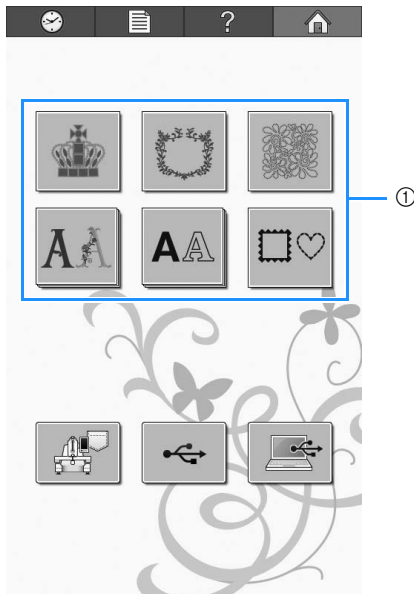

① Pattern type keys

In the pattern list screen, search for the desired pattern, and then touch the key for the pattern.

Pattern list screen (For details on the keys and other information on the screen, refer to page 62.)

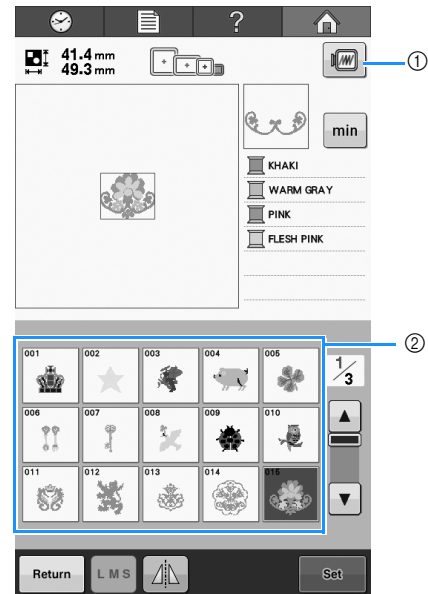

① Displays a preview image.

② Pattern keys

■ Checking a preview image from the pattern list screen

Touch  to preview the image prior to selecting.



Touch  to return to the pattern list screen.

Selecting an embroidery pattern

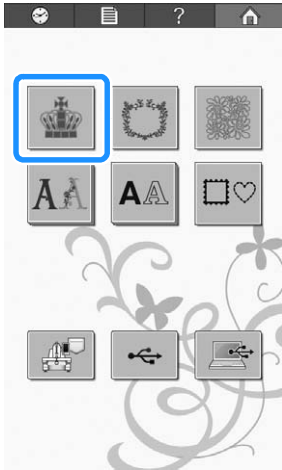
- 1** Touch  to select the embroidery patterns.



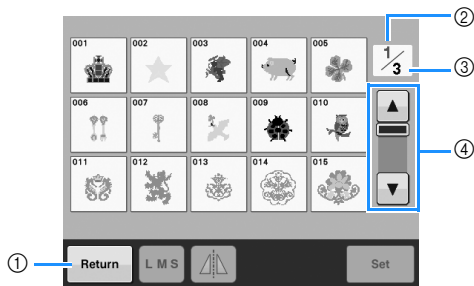

→ The pattern list screen appears.

- 2** Touch  (previous) or  (next) until the desired page is displayed.



- To select a pattern group other than the embroidery patterns, touch
 - Return key
 The pattern type selection screen appears.
 - Current page number
 - Total number of pages
 - Scroll key

Touch  (previous) or  (next) to move one page at a time, or touch anywhere on the bar to jump ahead for additional pages.

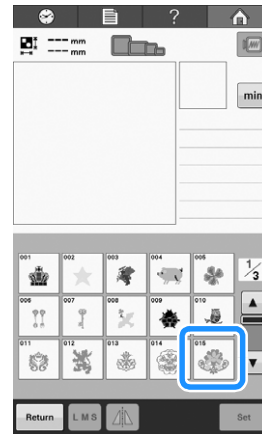

- 3** Touch the desired pattern.

For this example, touch .

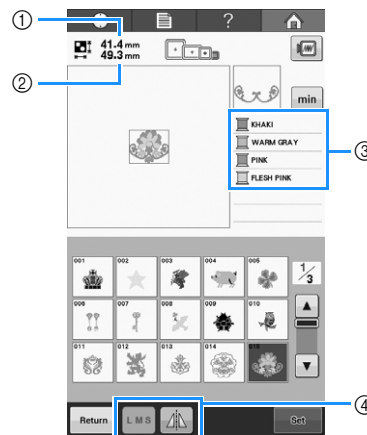

→ The selected pattern appears in the pattern display area.



- After a pattern is selected, the following appear:
 - Vertical length of the pattern
 - Horizontal width of the pattern
 - Thread information (Colors/Embroidering time) and the keys indicated by ④, which can be used to change the pattern size or get the mirror image of the pattern. The functions that can be used differ depending on the type of pattern that is selected. (Refer to “Changing the size of a pattern” on page 122.)
- Touch  to display the embroidering time of each thread color.
- Touch  to go back to the thread color display.
- If the wrong pattern was selected or you wish to select a different pattern, touch the desired pattern.

- 4** Touch  to display the next screen.

This confirms the pattern selection.

→ The pattern editing screen appears.

4. Editing the Embroidery Pattern

From this screen, the pattern can be edited.

Pattern editing screen (For details on the keys and other information on the screen, refer to page 63.)

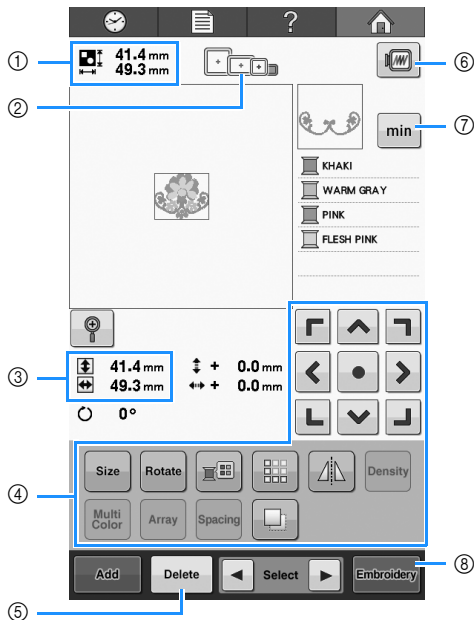

- ① Shows the size of the embroidery pattern currently displayed in the pattern display area. The top value shows the height and the bottom value shows the width. If the embroidery pattern consists of multiple patterns that have been combined, the size of the entire pattern, including all patterns, is shown.
- ② Highlights the sizes of embroidery frames that can be used to embroider the currently selected embroidery pattern.

Memo

- If the embroidery frame holder is not attached to the machine, the embroidering area will not display the correct frame size. (Refer to “Attaching the embroidery frame” on page 44.)

- ③ Shows the size of the currently selected embroidery pattern. The top value shows the height and the bottom value shows the width.
- ④ Touch to edit the pattern.
- ⑤ Touch this key to delete the pattern, for example, if the wrong pattern was selected. No pattern is selected and the pattern type selection screen appears.
- ⑥ Displays a preview image.
- ⑦ Touch to switch the thread information between the thread colors and embroidering time.
- ⑧ Continues to the next screen.

In this example, we will not edit the pattern. Without performing any editing operations, continue to the next screen.

Continuing to the embroidering screen

- 1 Press **Embroidery**.

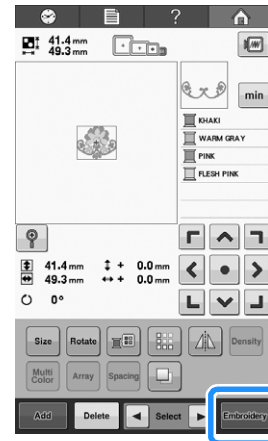

→ The embroidering screen is displayed.

5. Specifying Embroidering Setting

From this screen, the entire pattern can be edited and embroidering settings can be specified. In addition, the embroidering position can be checked and a pattern can be saved for later use.

Embroidering screen (For details on the keys and other information on the screen, refer to page 65.)

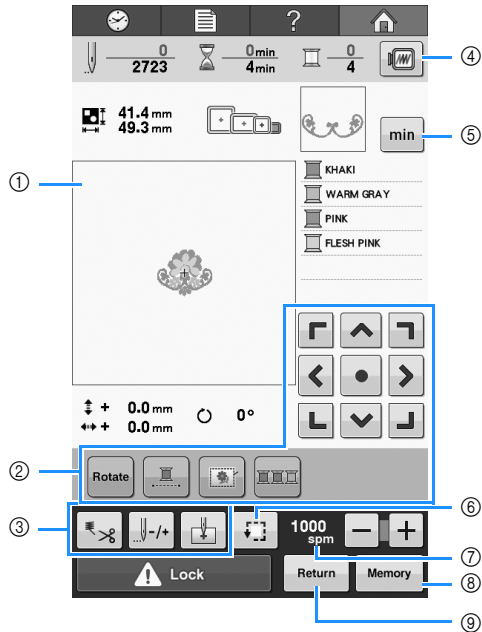

- ① In the embroidering settings screen, the embroidery frame guide in the pattern display area indicates the size of the installed embroidery frame.
- ② Touch to edit the pattern.
- ③ Touch these keys to specify how the pattern will be embroidered.
- ④ Displays a preview image.
- ⑤ Touch to switch the thread information between the thread colors and embroidering time.
- ⑥ Touch to check the embroidering area.
- ⑦ Touch **-** or **+** to change the embroidery speed.
- ⑧ Touch to store the pattern in memory.
- ⑨ Returns to the pattern editing screen.

In this example, we will not specify any of the embroidering settings. Continue with the next operation.

Embroidery positioning marker

The needle drop position is indicated with the LED pointer in the embroidering screen. Set the LED pointer to off or on in the settings screen. (Refer to "Setting the LED pointer" on page 149)

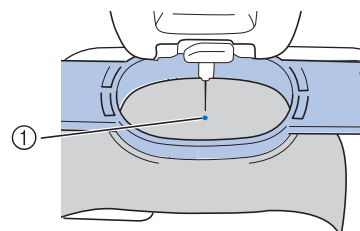
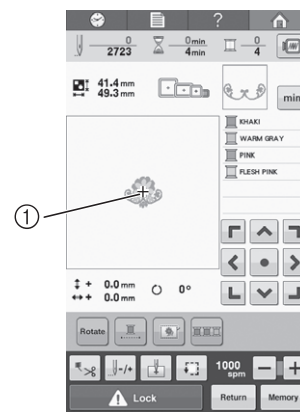

- ① Needle drop position
→ The LED pointer turns off when the embroidering starts.

6. Previewing the Image

You can view an image of the completed pattern within the embroidery frame.

Checking a preview image

Display the preview image to check that the embroidery will be sewn as desired.

1 Touch .

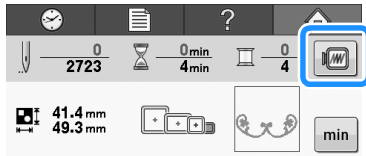

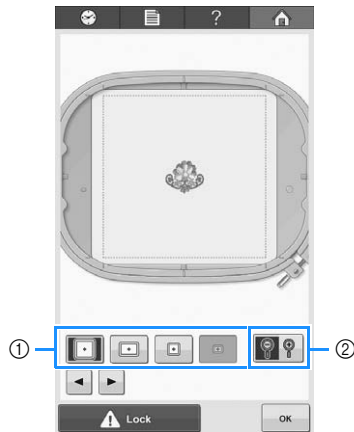

→ The preview image is displayed.





- ① Touch these keys to display the pattern in the various sizes of embroidery frames. The embroidery frames that appear in white on gray keys can be selected.
- ② Touch this key to display an enlarged view of the pattern.

Memo

- A preview image in a landscape orientation cannot be rotated to a portrait orientation, even if there is space at the top and bottom.

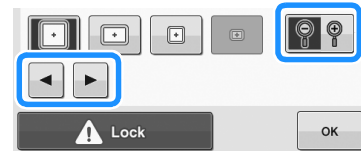
2 Touch  or  to select the type of embroidery frame holder, and then select the embroidery frame you are going to use. Touch  to display only the pattern (without the embroidery frame) so that it fills the screen.



- If you find out the type of embroidery frame holder and size of embroidery frame which are best for your embroidery, select the display guides in the settings screen for your better embroidery editing (Refer to "Embroidery frame types and applications" on page 74 and "Changing the display guides" on page 144).
- Touch  again to display the pattern with the embroidery frame.

3 Touch  to return to the previous screen.



Memo

- The embroidery can be sewn while the preview image is displayed in the embroidering screen. If the preview image is displayed in any screen other than the embroidering screen, the embroidery cannot be sewn.

7. Hooping the Fabric in the Embroidery Frame

After selecting the pattern to be embroidered, check which embroidery frames can be used to sew the pattern. Select the appropriate frame, and hoop the fabric and stabilizer in the embroidery frame. (Refer to “Attaching Iron-On Stabilizer (Backing) to Fabric” on page 76 and “Hooping the Fabric” on page 77.) For precautions concerning the fabric, refer to page 26.



Note

- If the fabric is not taut, the pattern may be misaligned or the fabric may pucker. Follow the procedure described below to firmly stretch the fabric in the embroidery frame so that the fabric is not loose. In addition, be sure to work on a level surface when putting the fabric in the embroidery frame.

Hooping the fabric in the embroidery frame

1 Select an embroidery frame.

From the sizes of embroidery frames indicated in the screen, select the embroidery frame that you wish to use.

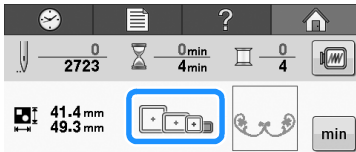

Embroidery frames that can be used appear lighter



Embroidery frames that cannot be used appear darker



Memo

- If the embroidery frame holder is not attached to the machine, the embroidering area will not display the correct frame size. (Refer to “Attaching the embroidery frame” on page 44.)

Embroidery frame types

There are various sizes of embroidery frames included with this machine. For details on the uses for each frame, refer to “Correctly Using the Embroidery Frames” on page 74.

Icon	Name
Embroidering area	
	Extra-large embroidery frame
	200 mm (H) × 200 mm (W) (7-7/8 inches (H) × 7-7/8 inches (W))
	Large embroidery frame (optional)
	130 mm (H) × 180 mm (W) (5-1/8 inches (H) × 7-1/8 inches (W))
	Medium embroidery frame
	100 mm (H) × 100 mm (W) (4 inches (H) × 4 inches (W))
	Small embroidery frame (optional)
	40 mm (H) × 60 mm (W) (1-5/8 inches (H) × 2-3/8 inches (W))
	Compact frame (70)
	41 mm (H) × 70 mm (W) (1-5/8 inches (H) × 2-3/4 inches (W))
	Compact frame (50)
	50 mm (H) × 50 mm (W) (2 inches (H) × 2 inches (W))
	Compact frame (44)
	38 mm (H) × 44 mm (W) (1-1/2 inches (H) × 1-3/4 inches (W))
	Compact frame (Portrait orientation)
	33 mm (H) × 75 mm (W) (1-5/16 inches (H) × 2-15/16 inches (W))

CAUTION

- If embroidery frames other than the six included frames are used, the embroidery frame may hit the presser foot and damage the machine, or cause injury to the user.

**Note**

- The embroidery frame indicators show all embroidery frame sizes in which the embroidery pattern can be sewn. Be sure to use an embroidery frame of the most suitable size. If the embroidery frame that is too large is used, the pattern may be misaligned or the fabric may pucker. (Refer to “Correctly Using the Embroidery Frames” on page 74.)

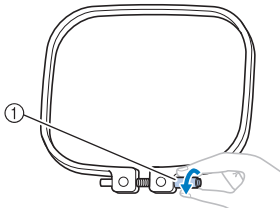
2 Loosen the screw on the outer frame.

① Screw

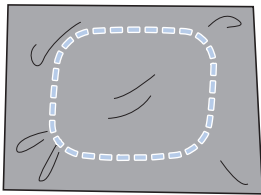
3 Place the fabric with the right side up on top of the outer frame.

- The outer frame does not have a front or back side. Either side can be used as the front.

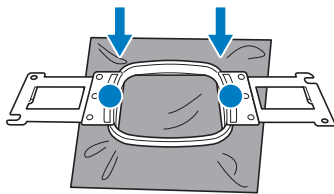
4 Press the inner frame into the outer frame.

- Be sure that there are no wrinkles in the fabric or stabilizer after they have been positioned in the embroidery frame.

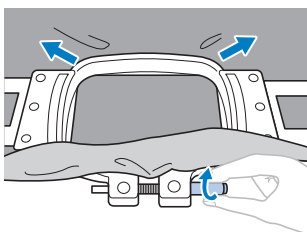
5 Lightly tighten the screw, and then pull the edges of the fabric.**6 Securely tighten the screw, and then check that the fabric is taut.**

- After securing the fabric, lightly tapping it should produce a drum-like sound.

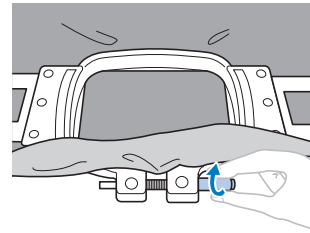

- Firmly clamp together the inner and outer frames so that the bottom of the inner frame is lower than the bottom of the outer frame.

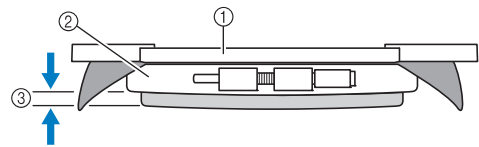

- ① Inner frame
- ② Outer frame
- ③ Bottom of inner frame

- Using the included screwdriver (large), firmly tighten the screw.

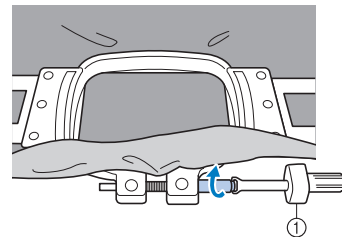

- ① Screwdriver (large)

The amount that the fabric is stretched and the use of stabilizer material differ depending on the type of fabric being embroidered. Try various methods to achieve the best embroidering results. (Refer to “Hooping techniques” on page 162.)

8. Attaching the Embroidery Frame to the Machine

After hooping the fabric in the embroidery frame, attach the frame to the embroidery machine.

⚠ CAUTION

- If the embroidery frame is not correctly attached, it may hit the presser foot and damage the machine, or cause injury to the user.
- When attaching the embroidery frame, make sure that the “Start/Stop” button is lit in red. If the “Start/Stop” button is flashing in green, the embroidery machine may start embroidering. If the embroidery machine accidentally starts operating, injuries may result.
- When attaching the embroidery frame, make sure that the embroidery frame does not hit any other part of the embroidery machine.



Note

- Before attaching the embroidery frame, check that there is enough thread in the bobbin.

Attaching the embroidery frame

Adjust the width of the embroidery frame holder to the size of the embroidery frame, and then attach the embroidery frame to the machine. As an example, the procedure for attaching the medium embroidery frame is described below.

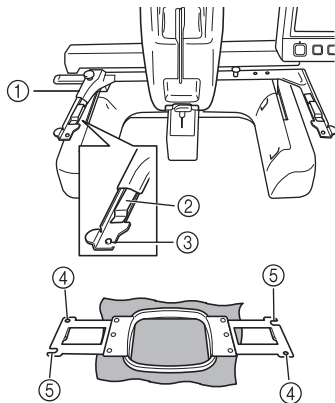

- ① Left arm of embroidery frame holder
Move the arm of the embroidery frame holder to the left or right to adjust it to the size of the embroidery frame.
- ② Clip on embroidery frame holder.
Insert the embroidery frame into the clips on the embroidery frame holder.
- ③ Positioning pin
- ④ Holes
- ⑤ Positioning slots

1 Loosen the two thumb screws on the embroidery frame holder.

If the screw is too tight, please use the included disc-shaped screwdriver.

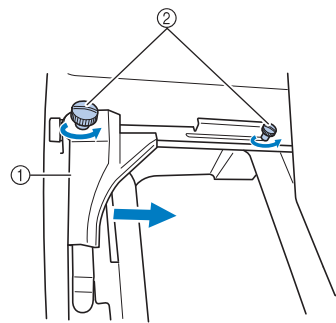

- ① Left arm
 - ② Thumb screws
- The left arm of the embroidery frame holder can be moved.
- Only loosen the thumb screws a maximum of 2 turns counterclockwise. Do not remove the screw.

- 2** Move the left arm to align the screw on the right side with the mark for the embroidery frame to be installed, and then tighten the thumb screws.

For this example, align with mark ③.

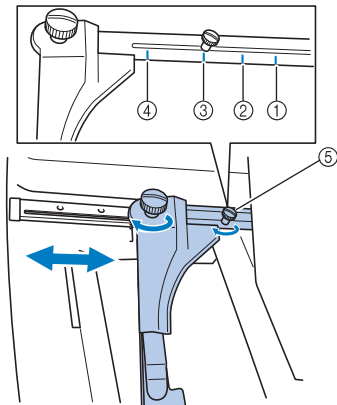

- ① Mark for extra-large embroidery frame
- ② Mark for large embroidery frame
- ③ Mark for medium embroidery frame
- ④ Mark for small embroidery frame
- ⑤ Align the screw with the mark.



Note

- Please firmly tighten the two thumb screws with included disc-shaped screwdriver. The machine will recognize the wrong frame size, if the two screws are not tightened.

→ The embroidery frame holder is ready for the embroidery frame to be attached.

- 3** Hold the embroidery frame level, and then simultaneously align both the left and right mounts with the embroidery frame holder clips.

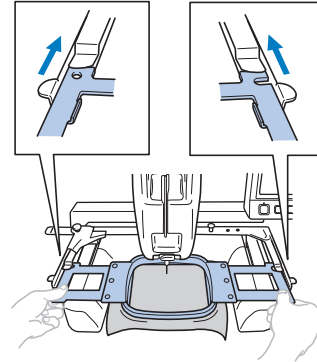

- The inner frame should be on top.



Note

- If the outer frame is on top, as shown below, the embroidery frame is incorrectly attached.

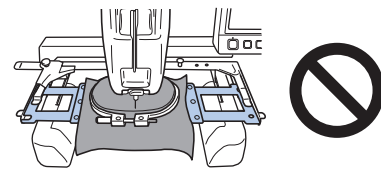

- 4** Insert the embroidery frame until it snaps into place.

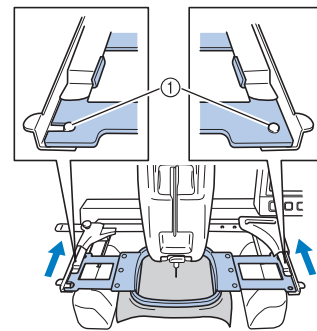

- ① Make sure that the pins on the left and right arms of the embroidery frame holder fit into the positioning slot and hole on the embroidery frame.

9. Checking the Embroidery Area

Check the embroidery area to make sure that the embroidery will be embroidered in the desired location and will not be misaligned and that the embroidery frame will not hit the presser foot.

If the embroidery frame is not correctly positioned, it moves to the correct position, and then the embroidering position is indicated.

1 Touch .

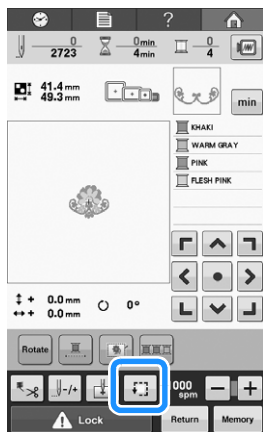

→ The embroidery position check screen appears.

2 From , press the key for the position that you want to check.

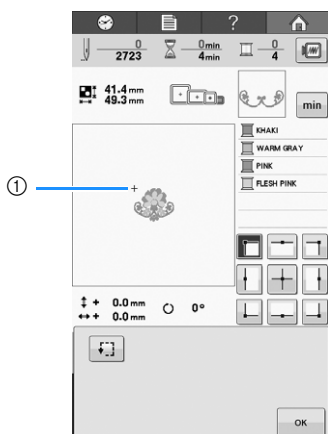

① Selected position

→ The needle will move to the selected position on the pattern.

3 Touch to see the entire embroidering area.

→ The presser foot is lowered and the embroidery frame moves to show the embroidery area.

4 The corners of the octagon showing the embroidery area for the pattern are indicated by changing direction.

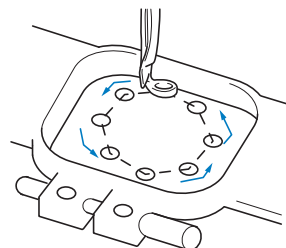

Carefully watch the movement of the embroidery frame and check that the embroidery is sewn in the desired location and that the embroidery frame does not hit the presser foot.

5 Touch to close the embroidery position check screen.

10. Upper Threading

In addition to checking the thread colors, information such as stitch count, stitching time and various other editing options can be performed in the embroidering screen.

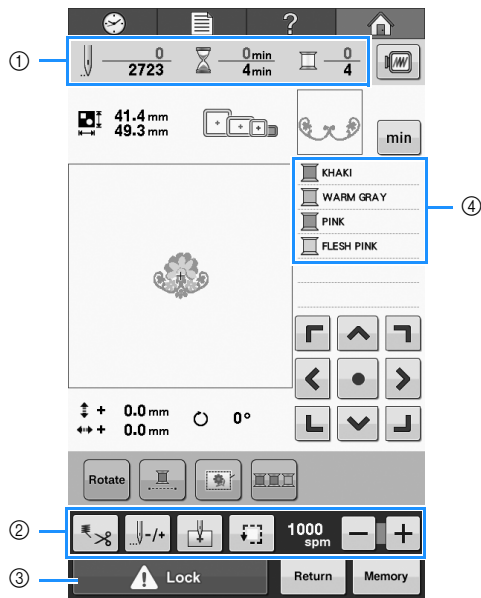

- ① Shows the number of stitches, the embroidering time, and the number of thread color changes.
- ② Use these keys to specify various editing settings.
- ③ To start the machine, touch this key to unlock the machine, and then press the “Start/Stop” button.
- ④ Shows the embroidering order for the thread colors, or embroidering time of each thread colors.

⚠ CAUTION

- When  (unlock key) in the embroidering screen is touched, the “Start/Stop” button begins flashing in green and the embroidery machine can start embroidering. If the upper threading is being performed or the needle is being threaded, be careful that the embroidery machine is not accidentally started, otherwise injuries may result.

Changing the display of thread information

- 1 Touch  to display the embroidering time of each thread colors.

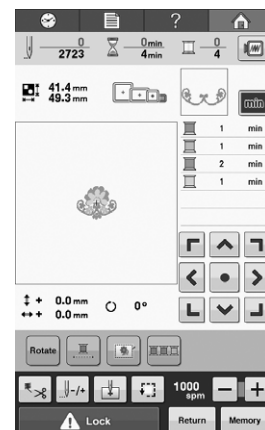
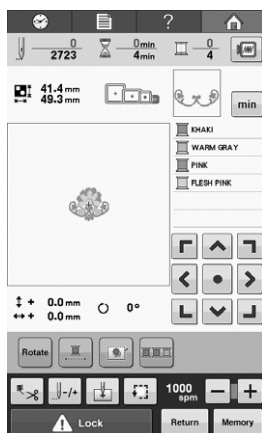

- 2 Touch  to go back to the thread color display.

Upper threading

Use embroidery thread to thread the needle bar.

⚠ CAUTION

- When threading the upper thread, carefully follow the instructions. If the upper threading is not performing correctly, the thread may break or become tangled, causing the needle to bend or break.

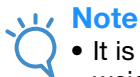

Note

- It is recommended that rayon or polyester embroidery thread be used (120 den/2, 135 dtex/2, 40 weight (in Americas and Europe), #50 (in Japan)).



Memo

- The path that the embroidery machine should be threaded is indicated by a line on the machine. Be sure to thread the machine as indicated.

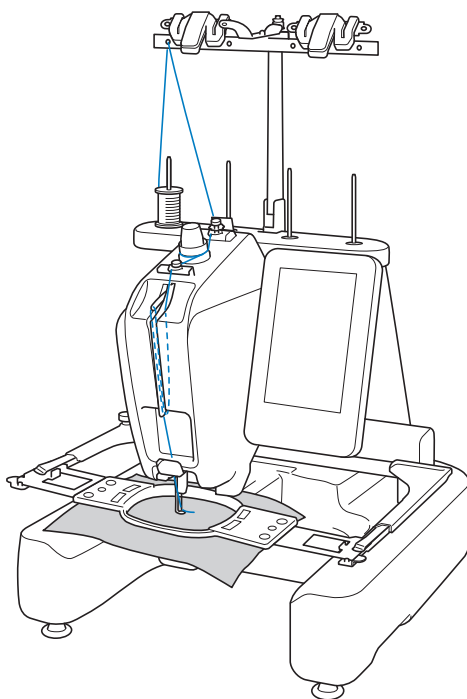

- 1** Place the thread spool on any spool pin among the 4 positions. Push the spool cap onto the spool pin as far as possible to secure the thread spool.

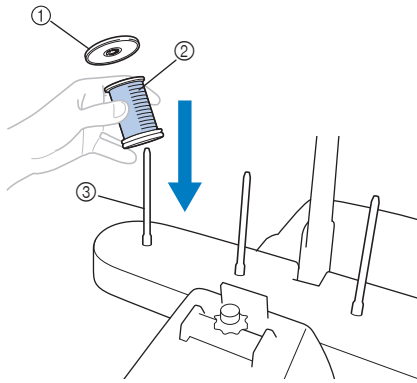

- ① Spool cap
② Thread spool
③ Spool pin

- When using small spools of thread, be sure to place the included spool mat on the spool pin before placing the spool on the pin.

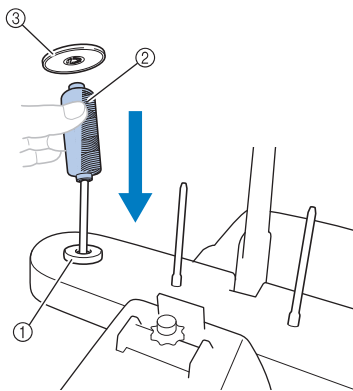

- ① Spool mat
② Small spool
③ Spool cap

- 2** Pass the thread from the back to the front through the hole in the thread guide just above the spool.

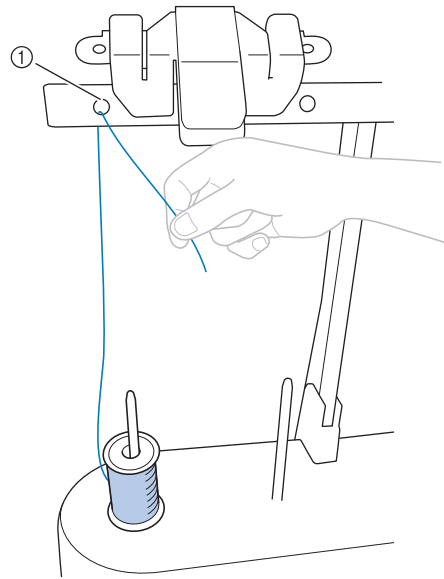

- ① Hole in the thread guide above the spool

- 3** Pull the thread toward you through the inside of the front hole in the thread guide.

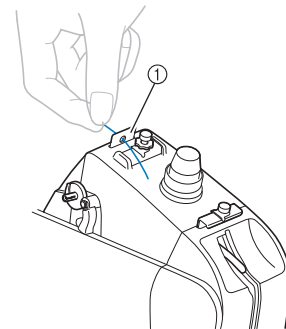

- ① Front hole in the thread guide

- 4** Hold the thread with both hands, and then pass it under the guide plate from the left.

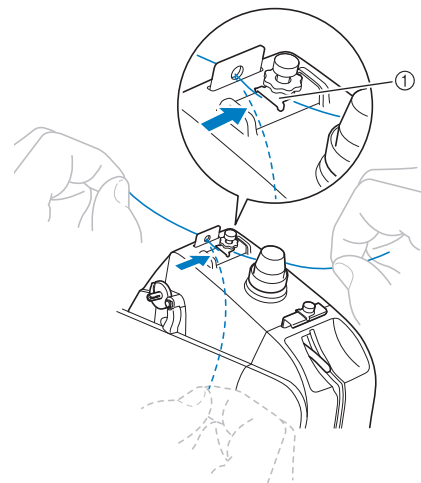

- ① Guide plate

- 5** Wind the thread clockwise once around the thread tension disc.

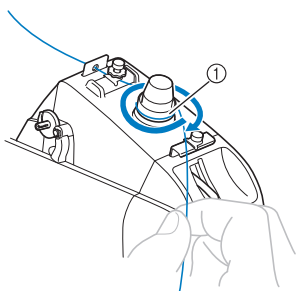

① Thread tension disc

- Make sure that the thread is securely caught in the thread tension disc.

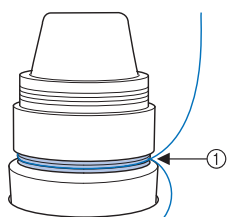

① Pass around here.

- 6** Pass the thread through the middle thread guide under the guide plate from the left.

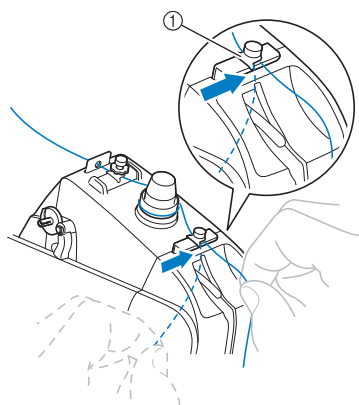

① Guide plate

- 7** Pass the thread along the slot to pass it through the thread take-up lever hole from the right side.

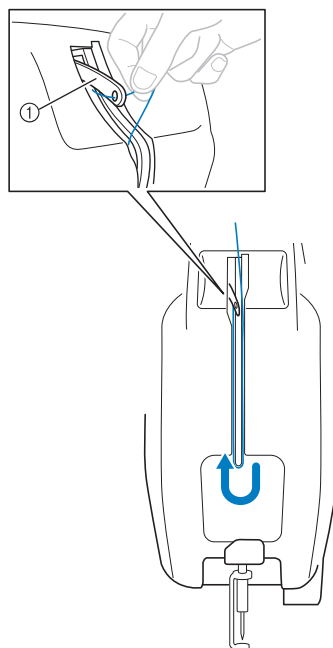

① Thread take-up lever

- 8** Drawing it down through the slot in the thread guide, then through the hole in the cover.

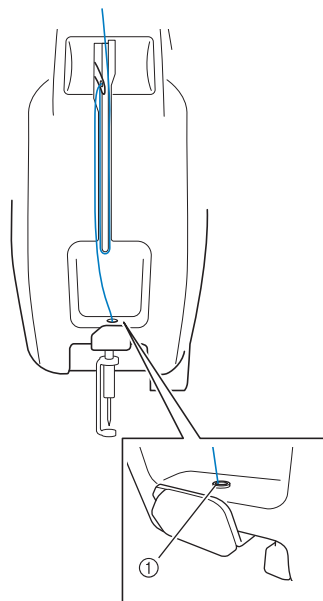

① Hole in the cover

- 9** Use the included threader to pass the thread through the needle bar thread guide.

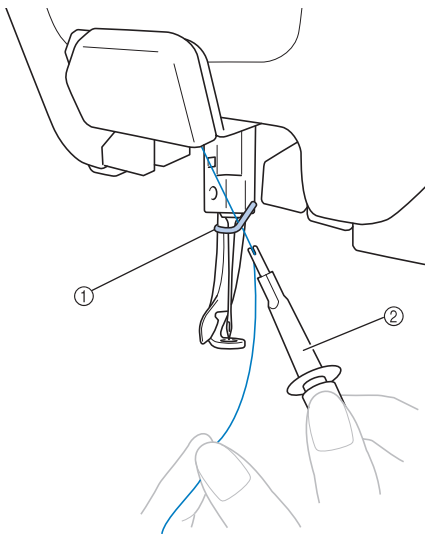

- ① Needle bar thread guide
② Needle changing tool (Threader)

Threading the needle

Use the automatic threading mechanism to thread the needle.

- 1** Press the “Automatic Threading” button.

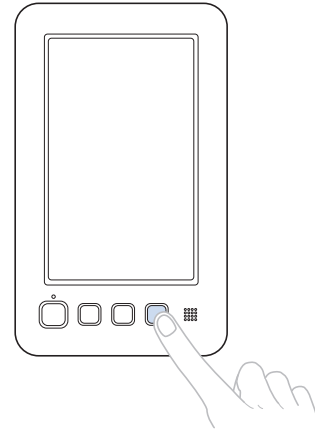

→ The hook on the automatic threading mechanism passes through the eye of the needle.

⚠ CAUTION

- If the needle is not fully inserted, the hook of the automatic threading mechanism will not pass through the eye of the needle during automatic needle threading, and the hook may bend or the needle cannot be threaded.
- If the hook of the automatic threading mechanism is bent or damaged, contact your authorized Brother dealer.
- While the hook of the automatic threading mechanism is passed through the eye of the needle, do not rotate the handwheel, otherwise the automatic threading mechanism may be damaged.



Note

- To avoid damage, the automatic threading mechanism may return to the back position when you turn the handwheel.

- 2** Pull out about 150 mm (6 inches) of thread. Then, as shown in the illustration, pass the thread under the fork of the automatic threading mechanism from the right, and then catch the thread with the hook that passes through the eye of the needle.

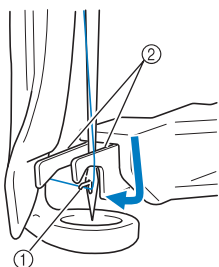

- ① Hook
- ② Fork



Note

- When catching the thread with the hook, be careful that the thread does not become loose.

- 3** Pass the thread under the guide on the presser foot.

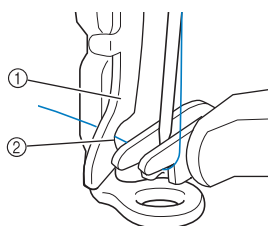

- ① Guide on presser foot
- ② Notch in guide on presser foot
- Make sure that the thread securely passes through the notch in the guide on the presser foot.

- 4** Securely pass the thread through the groove in the thread cutter, and then lightly pull the thread to cut it.

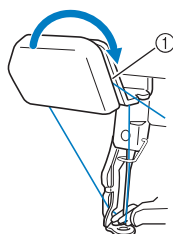

- ① Groove in thread cutter



Note

- If the thread is not correctly passed through the groove in the thread cutter, the message “Wiper error” appears and the needle cannot be threaded. Be sure to securely pass the thread through the groove.
- If enough thread is not pulled out, the thread cannot be pulled through the thread cutter.

- 5** Press the “Automatic Threading” button.

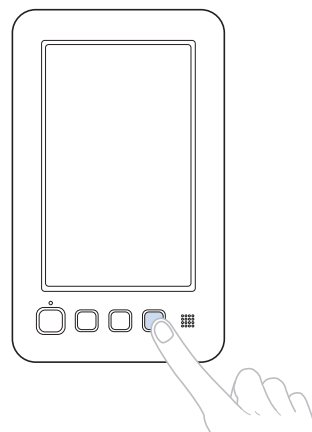

- The threader moves back away from the needle. The thread is pulled through the needle eye.
- The wiper comes out and catches the thread between the needle and the threader.
- The threader goes back to the original home position.

This completes the upper threading.

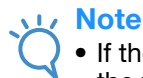

Note

- If the thread is not taut, it may come out of the thread tension disc. After upper threading is finished, check again to make sure that the thread is correctly passed into the thread tension disc. (Refer to step 5 on page 50.)

■ Using the spool net

When using metallic thread or any other strong thread, place the included spool net over the spool before embroidering.

If the spool net is too long, fold it once to match the size of the spool before placing it over the spool. It may be necessary to adjust thread tension when using the spool net.

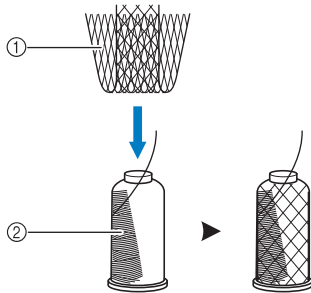

- ① Spool net
- ② Thread

Easily changing the thread spools

When replacing the thread spools, it is necessary to re-thread the upper thread. However, the thread spools can easily be changed when replacing a thread spool whose thread is correctly threaded through the machine.

- 1 Cut the thread between the thread spool and the thread guide.

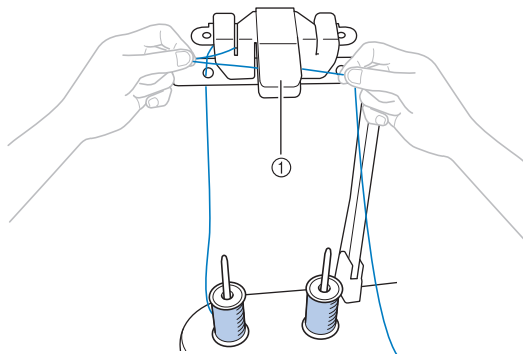

- ① Thread cutter

- 2 Change the thread spool.

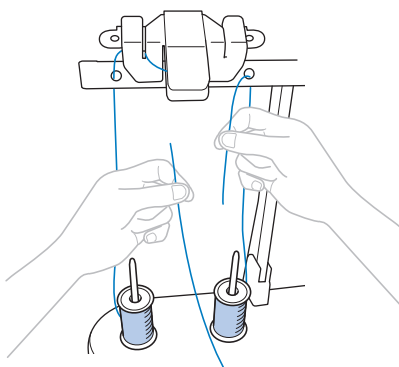

- 3 Tie the end of the thread on the new spool with the end of the thread remaining from the previous color.

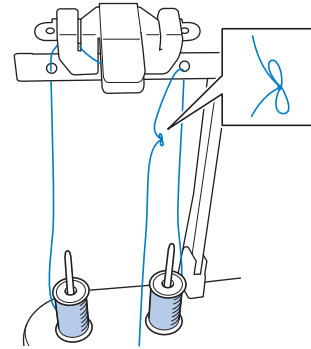

- 4 Pull out the old thread just after the needle bar thread guide.

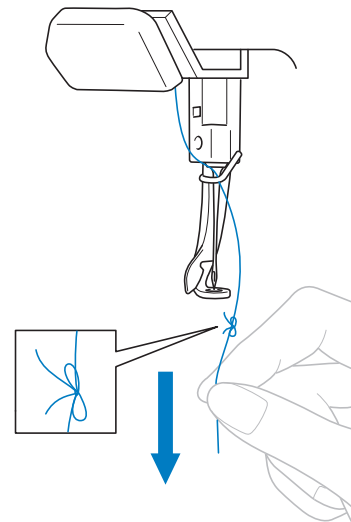

Continue pulling the thread until the knot is above the needle. Cut the knot.

- 5 Use the automatic threading mechanism to thread the needle with the new thread. (Refer to "Threading the needle" on page 51.)

→ This completes the changing of the thread spool.



Note

- When pulling out the thread, do not pull the knot through the eye of the needle. If the knot is pulled through the eye of the needle, the needle may be damaged.

11. Starting Embroidering

Now, the machine is ready to begin embroidering.

When the machine starts embroidering, the presser foot is automatically lowered, and then at the end of stitching, the necessary thread trimming operations are performed.

⚠ CAUTION

- For safety reasons, the embroidery machine must not be left unattended while it is embroidering.
- While the machine is in operation, pay special attention to the needle location. In addition, keep your hands away from all moving parts such as the needle, thread take-up lever and carriage, otherwise injuries may result.

■ Locking mechanism

For safety reasons, this embroidery machine is equipped with a locking function.

Normally, the embroidery machine is locked. Unless the machine is unlocked, it cannot start embroidering. If the embroidery machine is not started within 10 seconds after unlocking it, it automatically returns to being locked.

The “Start/Stop” button color shows whether or not the embroidery machine is locked. If the “Start/Stop” button lights up in red, the machine is locked. If the “Start/Stop” button flashes in green, the machine is unlocked.

Starting embroidering



Note

- Make sure that there are no objects within the moving area of the embroidery frame. If the embroidery frame hits another object, the pattern may become misaligned.

- 1 Touch  to unlock the embroidery machine.

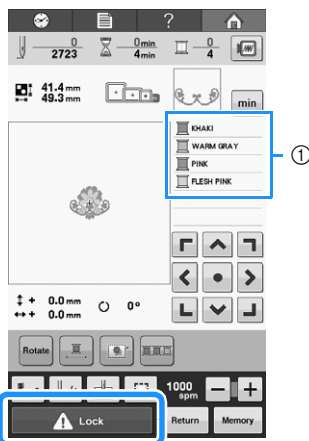

- ① The thread color being used for embroidering or will soon be used for embroidering appears at the top of the thread color sequence display. The remaining thread colors are listed in the embroidering order, starting from the top.

→ The “Start/Stop” button begins flashing in green and the embroidery machine can be started.

- If the “Start/Stop” button is not pressed within 10 seconds after unlocking the embroidery machine, the machine becomes locked again.

- 2 Press the “Start/Stop” button.

Press the “Start/Stop” button while it is flashing in green. If the “Start/Stop” button returns to being lit in red, perform this procedure again from step 1.

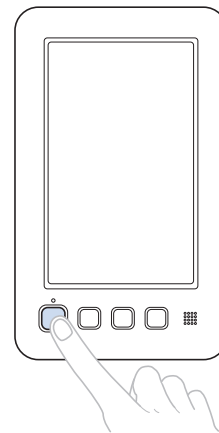

→ The “Start/Stop” button lights up in green and begins embroidering the first color.

- While the machine is embroidering, the point being embroidered is indicated by the green crosshairs in the pattern display area. In addition, the number of stitches and the time count up.

- 3 After embroidering of the first color is finished, the machine automatically stops and trims the thread.

- No thread trimming operations at the beginning of stitching and at the end of stitching are necessary.

Continuing embroidering

To select a new pattern, touch .

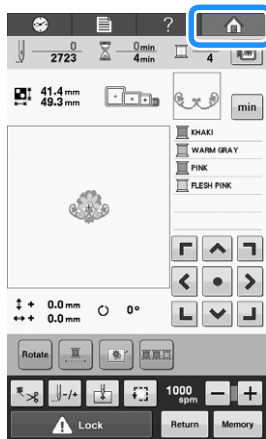

→ The pattern type selection screen appears.



Note

- The embroidering speed can be changed, even while the pattern is being embroidered. (Refer to “Maximum Embroidering Speed Setting” on page 99.)

Stopping embroidering

The machine can be stopped during embroidering.

Temporarily pausing

1 Press the “Start/Stop” button.

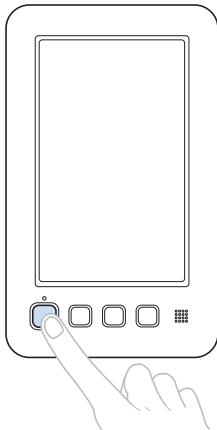

→ The machine stops and the “Start/Stop” button lights up in red.

- The thread is not trimmed.
- To continue embroidering, after checking that the upper thread is taut, touch the unlock key, and then press the “Start/Stop” button.

Resume embroidering after the machine was turned off

1 Press the “Start/Stop” button.

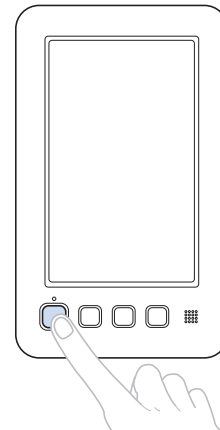

→ The embroidery machine stops and the “Start/Stop” button lights up in red.

- The thread is not trimmed.

2 Touch  to unlock the embroidery machine.

3 Press the thread trimming button.

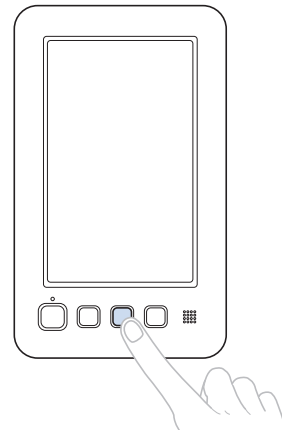

→ The bobbin and upper threads are trimmed.

- Before turning off the embroidery machine, be sure to trim the threads.

4 Set the main power switch to “O”.

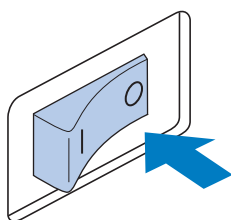

→ The embroidery machine is turned off and the display and the “Start/Stop” button indicator go off.

- Embroidering can resume after the embroidery machine is turned on again. Back up several stitches to overlap the stitching. For details, refer to “Resume Embroidering After Turning Off the Machine” on page 89.

■ If the thread breaks while embroidering

If a problem occurs while embroidering, such as if the thread breaks, the machine stops automatically. Re-thread the broken thread, back up several stitches, and then continue embroidering. For details, refer to “If the Thread Breaks or the Bobbin Thread Runs Out While Embroidering” on page 85.

12. Checking the Thread Tension

Check the embroidery to see if it was embroidered with the correct thread tension. If the thread tension is not adjusted correctly, the stitching may be uneven or there may be puckering in the fabric.

The upper thread tension can be adjusted using the thread tension knob or the upper thread guide pretension knob.

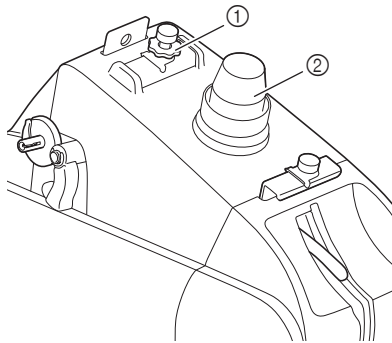

- ① Upper thread guide pretension knob
- ② Thread tension knob

■ Correct thread tension

From the wrong side of the fabric, the bobbin thread should be about one third of the stitch width.



- ① Right side
- ② Wrong side

If the embroidery appears as shown below, the thread tension is incorrect. Correct the thread tension.

The tension of the upper thread is too tight, resulting in the lower thread being visible from the right side of the fabric.

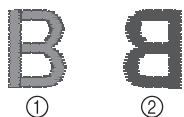

- ① Right side
- ② Wrong side

Loosen the thread tension knob or the upper thread guide pretension knob by turning counterclockwise.

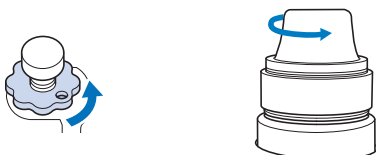

The tension of the upper thread is too loose, resulting in a loose upper thread, loose thread locks or loops appearing on the right side of the fabric.



- ① Right side
- ② Wrong side

Tighten the thread tension knob or the upper thread guide pretension knob by turning clockwise.

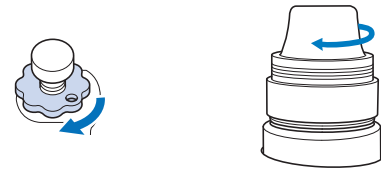

For details on adjusting the thread tension, refer to "Adjusting the Thread Tension" on page 91.



Note

- In this tutorial, the thread tension was checked after embroidering was finished. However, normally, embroidering should be temporarily paused and the thread tension should be checked after the first 100 stitches of each color embroidered.
- The resulting embroidery may not appear as expected, due to the type or thickness of the fabric being embroidered or to the type of stabilizer material used. Be sure to embroider a trial embroidery before embroidering on your project.

13. Removing the Embroidery Frame and Fabric

After embroidering is finished, remove the embroidery frame, and then remove the fabric from the frame.

Removing the embroidery frame

⚠ CAUTION

- When removing the embroidery frame, make sure that the “Start/Stop” button is lit in red. If the “Start/Stop” button is flashing in green, the machine may start embroidering. If the machine accidentally starts operating, injuries may result.
- When removing the embroidery frame, be careful that the embroidery frame does not hit any other part of the machine.
- Do not lift up the embroidery frame holder with extreme force, otherwise it may be damaged.

- 1 With both hands, grab the left and right sides of the arms of the embroidery frame holder, and then slightly lift up the frame.

The pins on the arms of the embroidery frame holder should come out of the holes in the sides of embroidery frame.

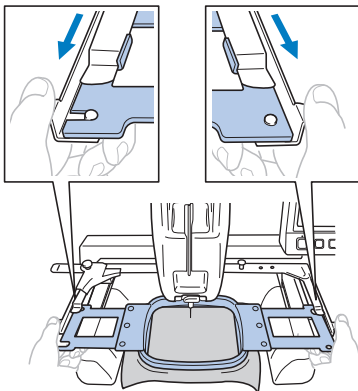

- 2 Pull off the embroidery frame toward you.

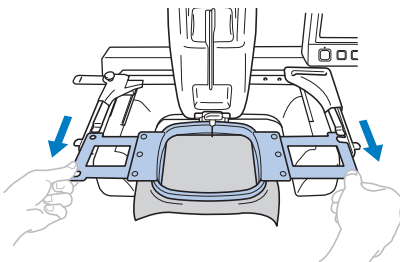

Removing the fabric

- 1 Loosen the outer frame screw.

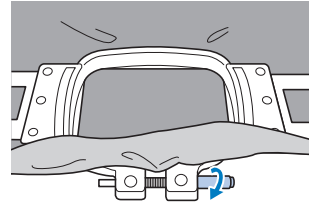

→ If the screw was tightened using a screwdriver (large), use the included screwdriver (large) to loosen it.

- 2 Remove the outer frame, and then remove the fabric.

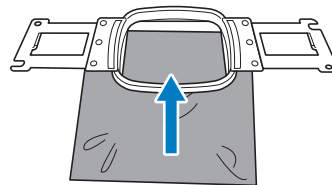

14. Turning OFF the Machine

After all embroidery is finished, turn off the machine.

- 1 Set the main power switch to "O".

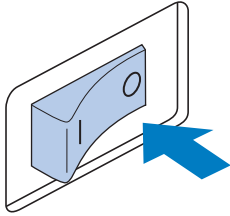

→ The embroidery machine is turned off and the display and the "Start/Stop" button indicator goes off.

- 2 Unplug the power supply cord from the electrical outlet.

Grasp the plug when unplugging the power supply cord.

- 3 If necessary, unplug the power supply cord from the machine.

Store the power supply cord in a safe place.

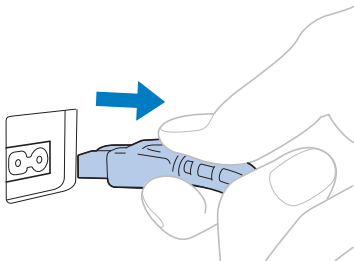

Note

- If a power outage occurs while the embroidery machine is being operated, turn off the embroidery machine and unplug the power supply cord. When restarting the embroidery machine, follow the necessary procedure to correctly operate the machine. (Refer to "1. Turning ON the Machine" on page 28.)

Memo

- If the machine is turned off while it is embroidering, embroidering can continue when the machine is turned on again. (Refer to "Resume Embroidering After Turning Off the Machine" on page 89.)

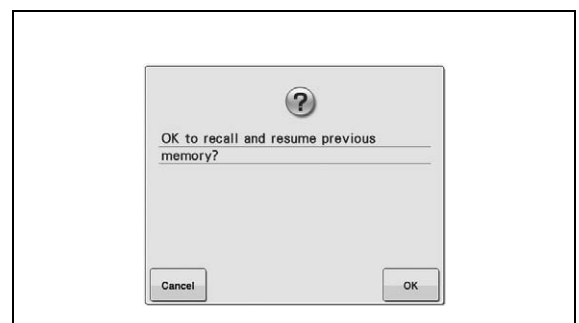
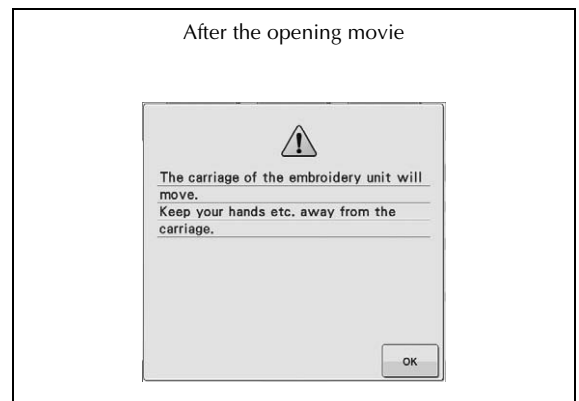
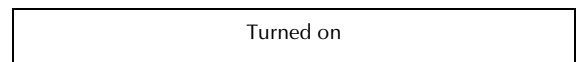
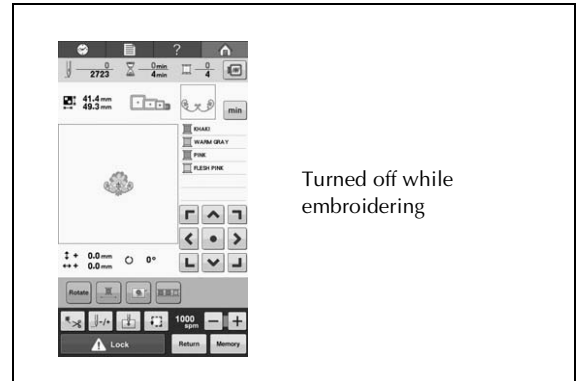

Screen Quick Reference Guide

Descriptions of the keys and other information that appear in the screens are provided in the tables below.

Key displays

The appearances of the keys have the following meanings.



(Normal color display) : This key is not selected, but can be selected.



(Dark-colored display) : This key is selected.



(Gray display) : This key cannot be selected.

Understanding the pattern type selection screen

In this screen, select a pattern category (type).

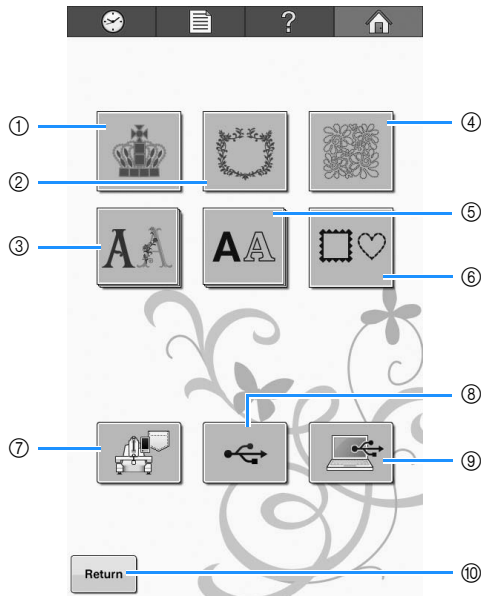

No.	Display	Function	Page
	Key Name		
①		Built-in patterns	p. 107
	Embroidery pattern key		
②			p. 107
	Decorative alphabet key		
③			p. 107
	Quilt design key		
④		p. 108	
	Alphabet key		
⑤		p. 107	
	Frame pattern key		

No.	Display	Function	Page
	Key Name		
⑦		Recalls patterns stored in the machine's memory.	p. 115
	Embroidery patterns stored in the machine memory key		
⑧		Recall patterns from USB media.	p. 116
	USB media keys		
⑨		By using the included USB cable to connect a computer to the embroidery machine, patterns can be recalled from the computer.	p. 117
	Computer (USB) key		
⑩		This key is not displayed unless a pattern is selected. Touch this key to quit trying to add another pattern from the pattern type selection screen. Return to the pattern editing screen.	p. 119
	Return key		

Understanding the pattern list screen

In this screen, select the pattern.

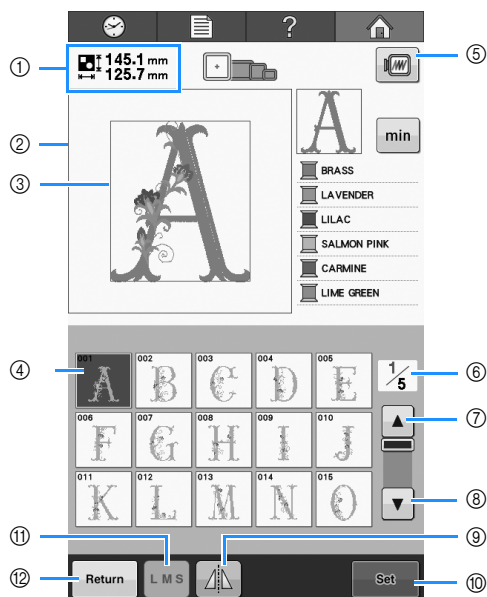

No.	Display Key Name	Function	Page
①	145.1 mm 125.7 mm Pattern size	Shows the size of the embroidery pattern currently displayed in the pattern display area. The top value shows the height and the bottom value shows the width. If the embroidery pattern consists of multiple patterns that have been combined, the size of the entire pattern, including all patterns, is shown.	
②	Pattern display area	This area displays the selected pattern.	
③	Embroidering area line	Shows the embroidering area for the large embroidery frame. The embroidery frame indications, the grid lines and other display settings can be specified from the machine settings screen.	p. 144
④	A Pattern keys	An image of the pattern appears on the key. Touch the image to select the pattern.	p. 106
⑤	min Preview key	Displays an image of the pattern that is to be embroidered so it can be previewed.	p. 41
⑥	1/5 Page	Shows the number of the currently displayed page and the total number of pages.	

No.	Display Key Name	Function	Page
⑦	 Previous page key	Touch this key to display the previous page.	p. 106
⑧	 Next page key	Touch this key to display the next page.	p. 106
⑨	 Horizontal mirror image key	Flips the pattern horizontally.	p. 121
⑩	 Set key	Touch after selecting the pattern. The selection of the pattern is confirmed and the pattern editing screen appears.	p. 106
⑪	 Size key	Allows the size of the currently selected embroidery pattern to be changed.	p. 109
⑫	 Return key	Touch to leave the currently selected pattern category and choose a different category. Returns to the pattern type selection screen.	p. 106

* Some patterns cannot be edited with ⑨ or ⑪.

Understanding the pattern editing screen

In this screen, the pattern can be edited.

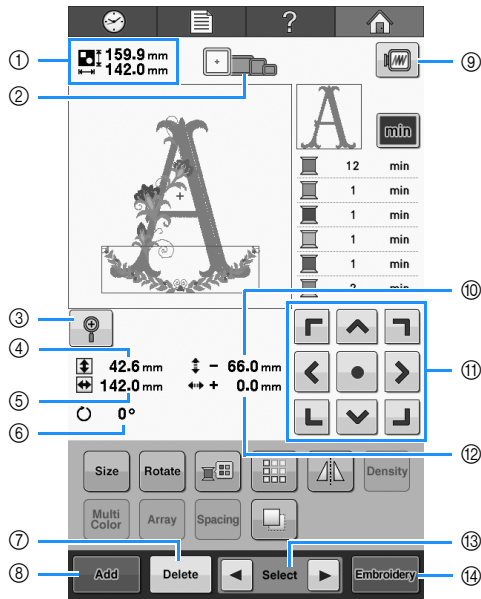

No.	Display Key Name	Function	Page
①	159.9 mm 142.0 mm Pattern size	Shows the size of the embroidery pattern currently displayed in the pattern display area. The top value shows the height and the bottom value shows the width. If the embroidery pattern consists of multiple patterns that have been combined, the size of the entire pattern, including all patterns, is shown.	
②	Embroidery frame indicators	Shows the sizes of embroidery frames that can be used to sew the embroidery pattern currently displayed in the pattern display area.	p. 42
③	Magnify key	Magnify the pattern by 200% in the screen.	p. 120
④	42.6 mm Size (vertical)	Shows the vertical length of the pattern that is being edited.	
⑤	142.0 mm Size (horizontal)	Shows the horizontal width of the pattern that is being edited.	
⑥	0° Rotation angle	Shows the rotation angle that the pattern being edited is rotated.	p. 123

No.	Display Key Name	Function	Page
⑦	Delete key	Deletes the pattern. If touched, the pattern being edited is deleted.	p. 136
⑧	Add key	Adds a pattern. If touched, the pattern group selection screen appears.	p. 119
⑨	Preview key	Displays an image of the pattern so that it can be previewed.	p. 41
⑩	- 66.0 mm Distance from center (vertical)	Shows the vertical distance that the pattern being edited is moved.	p. 121
⑪	Positioning keys	Moves the embroidering position of the pattern that is being edited in the direction of the arrow. (If is touched, the embroidering position is moved to the center of the embroidering area.)	p. 121
⑫	+ 0.0 mm Distance from center (horizontal)	Shows the horizontal distance that the pattern being edited is moved.	p. 121
⑬	Select Pattern selection keys	Selects the pattern that is being edited when the embroidery pattern consists of multiple patterns that have been combined.	p. 120
⑭	Embroidery key	Finish editing and continues to the embroidering screen.	p. 39

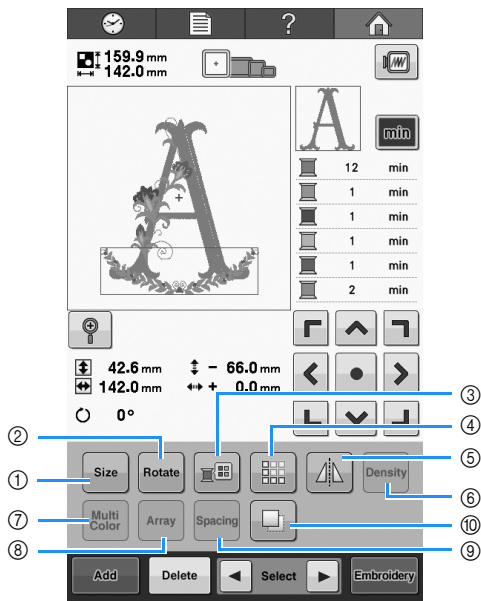

No.	Display	Function	Page
	Key Name		
⑨		Changes the spacing between the characters in the alphabet pattern that is being edited.	p. 124
	Spacing key		
⑩		Duplicates the pattern.	p. 136
	Duplicate key		

No.	Display	Function	Page
	Key Name		
①		Changes the size of the pattern that is being edited.	p. 122
	Size key		
②		Rotates the pattern that is being edited.	p. 123
	Rotate key		
③		Changes the color of the pattern.	p. 127
	Change thread color key		
④		Makes and edits a repeating pattern.	p. 128
	Border key		
⑤		Flips the pattern being edited horizontally.	p. 121
	Horizontal mirror image key		
⑥		Changes the density of the pattern that is being edited; can only be used if an alphabet or frame pattern is selected.	p. 126
	Density key		
⑦		Enables the thread color of each character in an alphabet pattern to be changed; can only be used when an alphabet is selected.	p. 126
	Multi Color key		
⑧		Changes the orientation of the characters in the alphabet pattern that is being edited.	p. 124
	Array key		

Understanding the embroidering screen



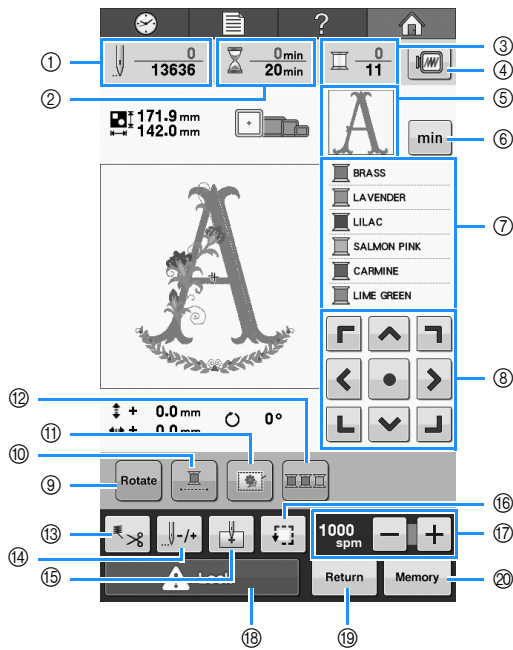

From this screen, the total number of thread colors and the embroidering time can be checked, and the needle placement forward or backward can be done.



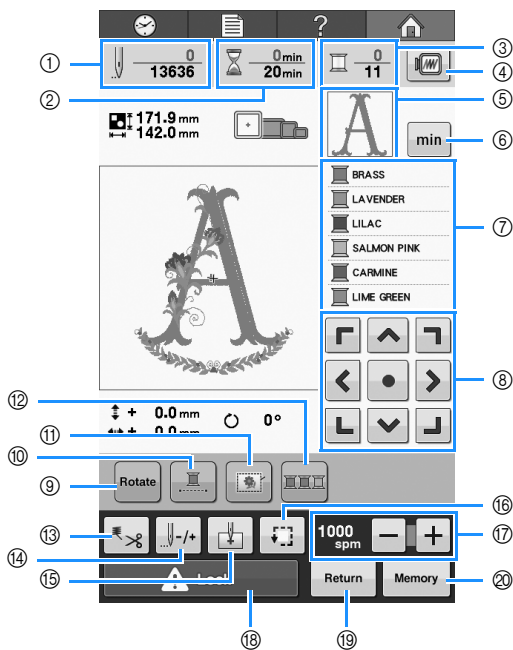

No.	Display	Function	Page
	Key Name		
①		The bottom value shows the total number of stitches in the pattern and the top value shows how many stitches have already been sewn.	
	Stitch count		
②		The bottom value shows the total amount of time required to embroider the pattern and the top value shows how much time has already passed sewing.	
	Embroidering time		
③		The bottom value shows the total number of thread colors in the pattern and the top value shows the thread color that is currently being embroidered.	
	Number of thread color changes		
④		Displays an image of the pattern that is to be embroidered so it can be previewed.	p. 41
	Preview key		
⑤		Shows the part of the pattern that will be embroidered with the thread color shown first in the thread color sequence display.	
	Region display		
⑥		Change the thread color sequence display to embroidering time of each thread colors.	p. 47
	Thread information (color/time)		

No.	Display	Function	Page
	Key Name		
⑦		Shows the order for the thread color changes. During embroidering, this display scrolls so that the color of the thread currently being sewn appears at the top.	
	Thread color sequence display		
⑧		Moves the embroidering position of the whole pattern in the direction of the arrow. (If is touched, the embroidering position is moved to the center of the embroidering area.)	p. 83
	Positioning keys		
⑨		Rotates the entire embroidery pattern when it consists of multiple patterns that have been combined.	p. 83, p. 137
	Rotate all key		
⑩		Embroider the selected pattern with a single color (monochrome).	p. 100
	Uninterrupted embroidery		
⑪		When stabilizer material is not affixed to the fabric, add basting stitches along the outline of the pattern to minimize shrinkage of the stitching and misaligned patterns.	p. 96
	Embroidery basting key		
⑫		Change the embroidery order so that the same color can be continuously embroidered.	p. 100
	Thread color sorting		



No.	Display	Function	Page
	Key Name		
13		Specify automatic thread cutting or thread trimming.	p. 101
	Thread trimming/cutting		
14		Moves the needle forward or backward through the stitching. Use this key in the following situations: <ul style="list-style-type: none"> • If the thread breaks or runs out while embroidering • To restart embroidering from the beginning • To continue embroidering after the machine was turned off 	p. 85
	Forward/Backward stitch key		
15		Specifies the needle position at the beginning of embroidering.	p. 97
	Starting position key		
16		Moves the embroidery frame so that the embroidering position can be checked.	p. 46
	Trial sewing key		
17		Specifies the maximum embroidering speed.	p. 99
	Maximum embroidering speed key		

No.	Display	Function	Page
	Key Name		
18		Unlocks the machine so it can start embroidering within 10 seconds. When this key is touched, the "Start/Stop" button flashes in green.	p. 54
	Unlock key		
19		Touch this key to quit embroidering and return to the embroidering edit screen.	
	Return key		
20		Save a pattern in the machine's memory, USB media or a computer.	p. 114
	Memory key		



Memo

- The thread color numbers in the thread color sequence display and the thread color set up display can be changed, for example, to the color name or the thread color number for other brands. (Refer to "Changing the thread color information" on page 145.)

When You Have a Question, This May Help You

TECHNICAL TERMS:

■ DST

This is the extension of Tajima data file (*.dst) that is one of the data formats of embroidery patterns. Tajima data does not contain color information, therefore the embroidery machine automatically assigns colors when a Tajima (.dst) file is loaded. (Refer to “Colors of Tajima (.dst) embroidery data” on page 159.)

■ Wiper

This is the mechanism for pulling the thread. The wiper pulls the thread when the needle threader is used.

The wiper also pulls the thread from the material when the machine trims the thread. This makes trimming threads after embroidering unnecessary. (Refer to page 52.)

PATTERNS:

Following patterns can be processed by the machine to embroider.

- Embroidery data with *.pes, *.phc or *.dst format.
Use USB media to transfer the data to the machine.
Using the USB cable, the data can be transferred from the PC to the machine.
- Optional embroidery cards
- Embroidery patterns created by digitizing software program
- The patterns saved on USB media by the machine

EMBROIDERING:

■ Customize the embroidery colors

- Use the thread color function by selecting either 64 colors or 300 colors, or by setting the custom thread color table on the pattern editing screen. For more details, refer to “Creating a custom thread table” on page 132 and “Choosing a color from the custom thread table” on page 135.

■ Resume an unfinished pattern from the last time the machine was switched off.

- The machine remembers the pattern and the position even after turning off the power. And the machine can resume the embroidery when the machine turns on again. (Refer to “Resume Embroidering After Turning Off the Machine” on page 89.)

■ Getting false thread breakage error

- Check that the position of the upper thread is under the upper thread guide plates. (Refer to page 49.)
- Check that the position of the upper thread is around the thread tension disc. (Refer to page 50.)

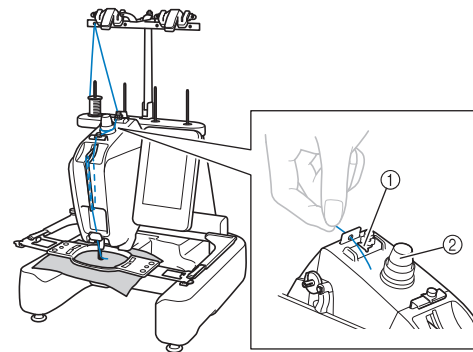

- ① Upper thread guide plates
- ② Thread tension disc

■ Thread tension changed suddenly

- Thread is caught on a rough edge of the spool of upper thread.
- Upper thread is caught under the spool of thread.
- The thread dust or lint is gathered under the bobbin's tension spring.

■ The frame came out from the carriage

Make sure that the positioning pins are placed into the frame's positioning slot and hole. (Refer to page 44.)

To insure proper registration of pattern for embroidery, turning off the machine and turning it back on will allow the embroidery arm to reset its registration points.

■ Cancel the current pattern and start again

Select the "Home" key on the upper right of the screen. The pattern and all information will be deleted. (Refer to "Understanding the screens" on page 30.)

USB connectivity

You can perform many functions using the USB ports on the machine. Connect the appropriate devices according to the features of each port.

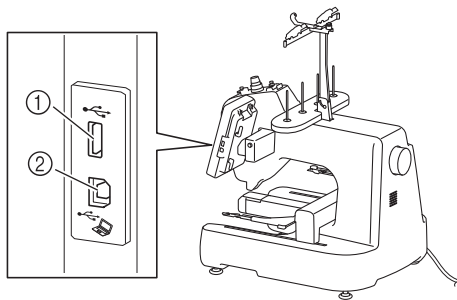

- ① USB port
- ② USB port for computer



Note

- The processing speed may vary by port selection and quantity of data.
- Do not insert anything other than USB media into the USB media port. Otherwise, the USB media drive may be damaged.

■ Using USB media or embroidery card Reader/USB card writer module*

When sending or reading patterns using the USB media or the embroidery card Reader/USB card writer module*, connect the device to the USB port.

- * If you have purchased the PE-DESIGN Ver5 or later, PE-DESIGN NEXT, PE-DESIGN Lite or PED-BASIC, you can plug the included USB card writer module into the machine as an embroidery card reader, and recall patterns.

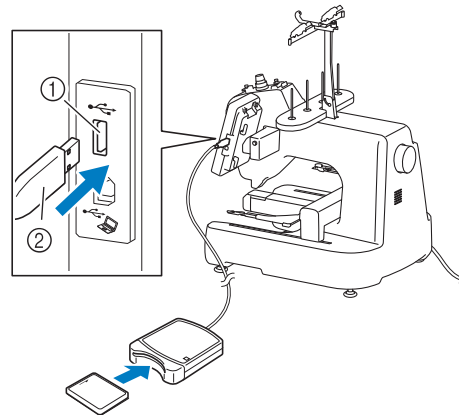

- ① USB port
- ② Embroidery card Reader/USB card writer module* or USB media



Note

- Use only an embroidery card reader designed for this machine. Using an unauthorized embroidery card reader may cause your machine to operate incorrectly.
- Embroidery patterns cannot be saved from the machine to an embroidery card inserted into a connected USB card writer module.



Memo

- USB media is widely used, however some USB media may not be usable with this machine. Please visit our website (<http://support.brother.com>) for more details.
- Depending on the type of USB media being used, either directly plug the USB device into the machine's USB port or plug the USB media Reader/Writer into the machine's USB port.

■ Connecting the machine to the computer

Using the included USB cable, the embroidery machine can be connected to your computer.

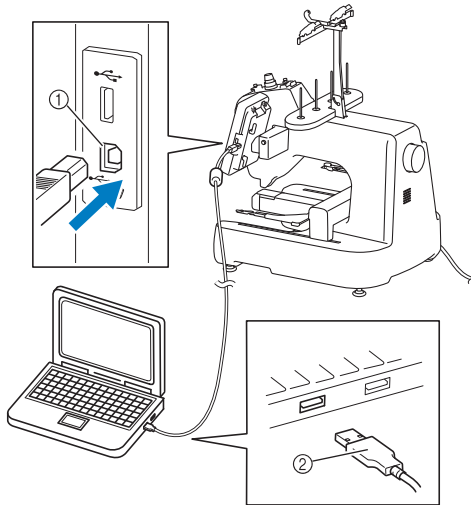

- ① USB port for computer
- ② USB cable connector



Note

- The connectors on the USB cable can only be inserted into a port in one direction. If it is difficult to insert the connector, do not insert it with force. Check the orientation of the connector.
- For details on the position of the USB port on the computer (or USB hub), refer to the instruction manual for the corresponding equipment.

Chapter 3

OTHER BASIC PROCEDURES

This chapter provides explanations on operations other than those described in Chapter 2, such as, changing the needles and changing thread spools.

Changing the Needle	72
Replacing the needle	72
Correctly Using the Embroidery Frames	74
Embroidery frame types and applications	74
Attaching Iron-On Stabilizer (Backing) to Fabric	76
Hooping the Fabric	77
Hooping the fabric in the large embroidery frame	77
Hooping the compact frame and attaching to the machine	78
■ Removing the compact frame	79
Using the embroidery sheet	79
Large/small pieces of fabric	80
■ Embroidering large pieces of fabric or heavy clothing	80
■ Embroidering small pieces of fabric	80
■ Embroidering the corner of fabric	80
■ Embroidering narrow pieces of fabric, such as ribbon	80
Embroidery Frame Position and Movement	81
■ Embroidery frames that cannot be used for embroidering	81
■ Moving to the correct position	81
Changing the Embroidering Position	83
Adjusting the angle	83
If the Thread Breaks or the Bobbin Thread Runs Out While Embroidering	85
If the upper thread breaks	85
If the bobbin thread breaks or runs out	86
■ If the bobbin thread ran out, replace the bobbin at this point in the procedure	86
Embroidering From the Beginning or Middle of the Pattern	87
■ To start embroidering from the beginning	87
■ To select the stitch from where embroidering is to begin	88
Resume Embroidering After Turning Off the Machine	89
Adjusting the Thread Tension	91
Adjusting the tension of the bobbin thread	91
Adjusting the tension of the upper thread	92
■ Correct thread tension	92
■ Upper thread is too tight	92
■ Upper thread is too loose	93

Changing the Needle

If the needle is bent or the tip of the needle is broken, replace the needle with a new one. Use the included Allen screw driver to replace the needle with one that is designed specifically for this machine and that passes the test described in “Checking the needle” on page 25.

Replacing the needle

- 1 Turn off the embroidery machine.

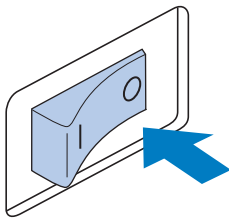

⚠ CAUTION

- Be sure to turn off the embroidery machine before replacing the needle, otherwise injuries may result if the machine starts embroidering.

- 2 Loosen the needle set screw and remove the needle.

Hold the needle with your left hand, and then hold the Allen screw driver in your right hand and turn the needle set screw counterclockwise.

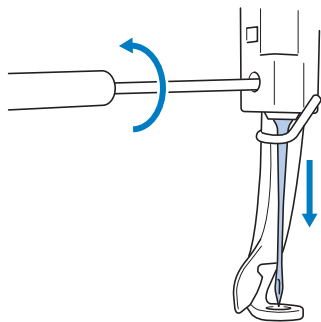

Note

- Be sure to use the included Allen screw driver to replace the needle, otherwise too much force may be applied to the needle, causing it to break.

- Do not apply extreme force when loosening or tightening the needle set screw, otherwise the machine may be damaged.

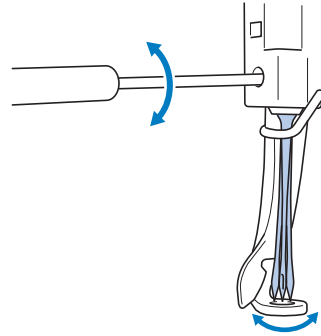

- 3 With the flat side of the needle toward the back of the machine, insert the needle all the way up until it touches the needle bar stopper.

Pass the needle through the hole in the presser foot, and then use the needle changing tool to lift up the needle.

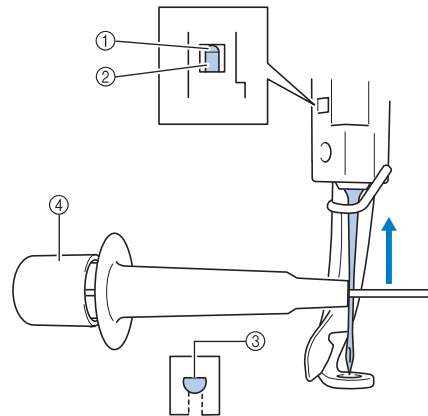

- 1 Needle bar stopper
- 2 Needle
- 3 Flat side of needle
- 4 Needle changing tool

Hold the needle changing tool and press the end of the needle changing tool ① in to extend the needle-mounting clamp ②. Attach the clamp to the needle, and then release the pressed area to clamp the needle. To unclamp the needle, press ① again.

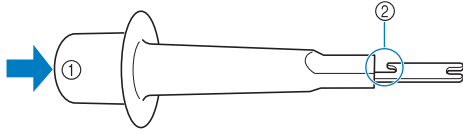

- ① End of the needle changing tool
- ② Needle mounting clamp

4 While holding the needle in place with your left hand, tighten the needle set screw.

Use the Allen screw driver to turn the needle set screw clockwise.

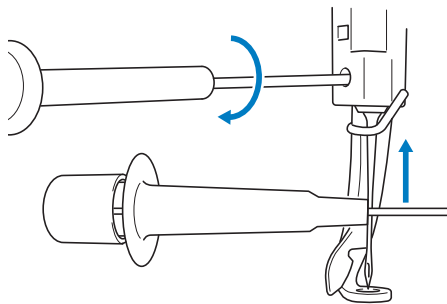

⚠ CAUTION

- Be sure to insert the needle all the way up until it touches the needle bar stopper and securely tighten the needle set screw with the Allen screw driver, otherwise the needle may break or the machine may be damaged.
- If the needle is not fully inserted, the hook of the automatic threading mechanism will not pass through the eye of the needle during automatic needle threading, and the hook may bend or the needle cannot be threaded.
- If the hook of the automatic threading mechanism is bent or damaged, contact your authorized Brother dealer.

Correctly Using the Embroidery Frames





Various types of embroidery frames can be used with this machine to suit your project by changing the embroidery frame holders.



In addition to the two included embroidery frames, there are many frames that can be used with this embroidery machine. (Refer to “Optional accessories” on page 17.)

⚠ CAUTION

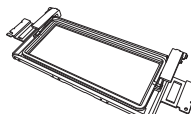
- Only use embroidery frames of the sizes indicated in the screen, otherwise the embroidery frame may hit the presser foot, which may result in injuries.

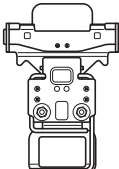
Embroidery frame types and applications

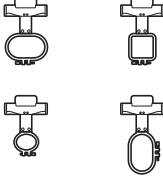
Embroidery type	Embroidering area		Reference
	Image	Usage	
Embroidery frame holder a	Flat frame (optional)	200 mm (H) × 200 mm (W) (7-7/8 inches (H) × 7-7/8 inches (W))	Visit your nearest authorized Brother dealer.
		Use when embroidering jackets and other thick garments.	
	Extra large embroidery frame	200 mm (H) × 200 mm (W) (7-7/8 inches (H) × 7-7/8 inches (W))	(Refer to “Hooping the Fabric” on page 77.)
		Use when embroidering patterns with a size less than 200 mm (H) × 200 mm (W) (7-7/8 inches (H) × 7-7/8 inches (W))	
	Medium embroidery frame	100 mm (H) × 100 mm (W) (4 inches (H) × 4 inches (W))	
	Use when embroidering medium-sized patterns.	(Refer to “7. Hooping the Fabric in the Embroidery Frame” on page 42.)	
Embroidery frame holder b (optional)	Border frame (optional)	100 mm (H) × 180 mm (W) (4 inches (H) × 7-1/8 inches (W))	Visit your nearest authorized Brother dealer.
		Use when embroidering a long string of characters or patterns.	
Embroidery frame holder c (optional)	Round frame (optional) ∅=diameter	∅100 mm (4 inches) ∅130 mm (5 inches) ∅160 mm (6 inches)	Visit your nearest authorized Brother dealer.
		Use when adding a built-in embroidery pattern to a sleeve. Select the frame appropriate for the size of the pattern.	
Embroidery frame holder d (optional)	Clamp frame S (optional)	24 mm x 45 mm (7/8 inch x 1-3/4 inches)	Visit your nearest authorized Brother dealer.
		Use for embroidering specially shaped items that cannot be held in a traditional frame, such as shoes and gloves.	

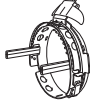
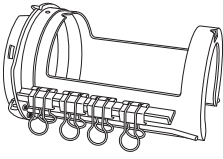
Embroidery type	Embroidering area		Reference
	Usage		
 Embroidery frame holder e	Compact frame (70/50/44/ Portrait orientation) 	 70: 41 mm (H) × 70 mm (W) (1-5/8 inches (H) × 2-3/4 inches (W)) 50: 50 mm (H) × 50 mm (W) (2 inches (H) × 2 inches (W)) 44: 38 mm (H) × 44 mm (W) (1-1/2 inches (H) × 1-3/4 inches (W)) Portrait orientation: 33 mm (H) × 75 mm (W) (1-5/16 inches (H) × 2-15/16 inches (W)) Use for embroidering small patterns or names on sleeves or pockets of pre-assembled products such as shirts, bags, and so on.	Refer to “Hooping the compact frame and attaching to the machine” on page 78.
Cap frame (optional)	<Advanced type 2> 	60 mm (H) × 130 mm (W) (2-3/8 inches (H) × 5-1/8 inches (W)) Use when embroidering caps. Baseball (golf) caps, tulip hats and bucket hats can be embroidered with these frames. These frames cannot be used with hats having a front area of 50 mm (2 inches) or less, such as sun visors and children’s hats. In addition, these cannot be used with hats that have a brim longer than 80 mm (3-1/8 inches).	Visit your nearest authorized Brother dealer.
Cylinder frame (optional)		80 mm (H) × 90 mm (W) (3 inches (H) × 3-1/2 inches (W)) Use when embroidering tubular and curved fabric, such as shirt sleeves and trousers.	Visit your nearest authorized Brother dealer.



Note

- The embroidery frame indicators show all embroidery frame sizes in which the embroidery pattern can be sewn. Be sure to use an embroidery frame of the most suitable size. If the embroidery frame that is too large is used, the pattern may be misaligned or the fabric may pucker.

Attaching Iron-On Stabilizer (Backing) to Fabric

In order to prevent shrinkage of the stitching or misaligned patterns, we recommend that iron-on stabilizer (backing) be used for embroidering.

⚠ CAUTION

- When embroidering on thin or stretch fabrics, fabrics with a coarse weave or fabrics that easily allow the stitching to shrink, be sure to use iron-on stabilizer (backing) for embroidering. If iron-on stabilizer (backing) is not used while embroidering, the needle may bend or break or the pattern may become misaligned.

- 1 Using a steam iron, affix the iron-on stabilizer (backing) to the back of the fabric.

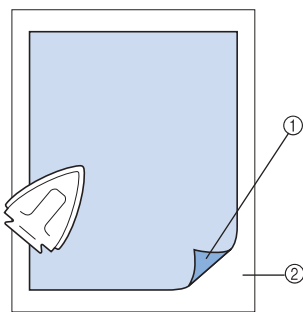

- ① Adhesive side of iron-on stabilizer (backing)
- ② Fabric (wrong side)

- When embroidering fabric that should not be ironed or when embroidering an area that is difficult to iron, hoop a layer of the iron-on stabilizer (backing) under the fabric in the embroidery frame without ironing it.



Note

- Use a piece of iron-on stabilizer (backing) that is larger than the embroidery frame. When framing the fabric in the embroidery frame, be sure that the stabilizer (backing) is clamped on all edges in order to prevent wrinkles in the fabric.

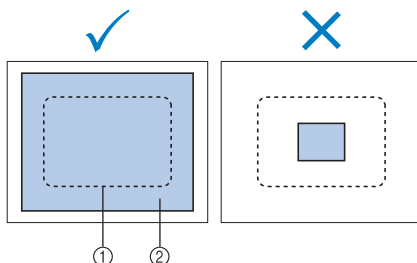

- ① Area of embroidery frame
- ② Iron-on stabilizer (backing)



Memo

- When embroidering thin fabrics, such as organza or lawn, use a water-soluble stabilizer (backing). Water-soluble stabilizers dissolve when washed, allowing you to create beautiful embroidery that is not stiff.
- When embroidering fabric with a nap, such as towels or corduroy, hoop a layer of iron-on stabilizer (backing) under the fabric in the embroidery frame without ironing it.
- For other uses of stabilizer (backing), refer to “Stabilizers (backing)” on page 161.

Hooping the Fabric

Hooping the fabric in the large embroidery frame

- 1 Loosen the screw on the outer frame.

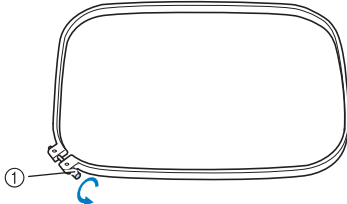

① Screw

- 2 Place the fabric with right side up on top of the outer frame.

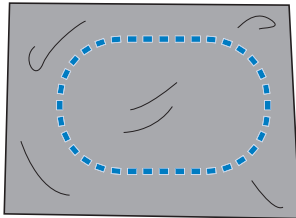

- The outer frame does not have a front or back side. Either side can be used as the front.

- 3 Press the inner frame into the outer frame.

First insert the inner frame at the corner with the screw (A), next insert the nearby one corner (B), and then insert the opposite corner (C). Then insert the opposite corner of non screw corner (D).

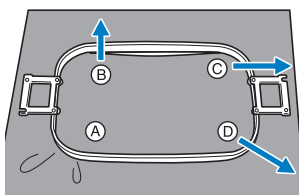

First, align the inner and outer frames at the corner with the screw (A). Then, while lightly pulling the fabric in the direction indicated by arrow (B) so that the fabric is taut, insert the inner frame at corner (B). In the same way, lightly pull the fabric in the direction indicated by arrow (C) and insert corner (C), and then lightly pull the fabric in the direction indicated by arrow (D) and insert corner (D).

- Be sure that there are no wrinkles in the fabric after it is stretched in the embroidery frame.

- 4 While stretching the fabric even more, securely tighten the screw so that the fabric is taut.

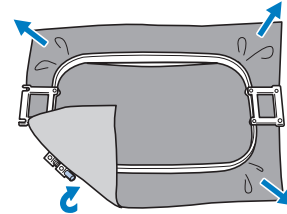

- After stretching the fabric, lightly tapping it should produce a drum-like sound.
- Firmly clamp together the inner and outer frames so that their tops are even.

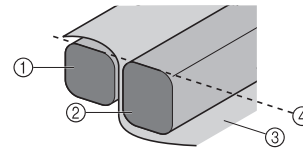

- ① Outer frame
- ② Inner frame
- ③ Right side of fabric
- ④ Top of inner and outer frames are even

- Using the included screwdriver (large), firmly tighten the screw.

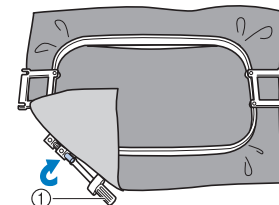

- ① Screwdriver (large)



Memo

- To correctly frame the fabric in the embroidery frame, we recommend using a flat surface.

Hooping the compact frame and attaching to the machine

Attach the embroidery frame holder e before using the compact frame.

1 Loosen the screw on the outer frame.

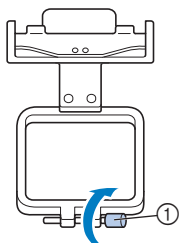

① Screw

2 Place the fabric with right side up on top of the outer frame.

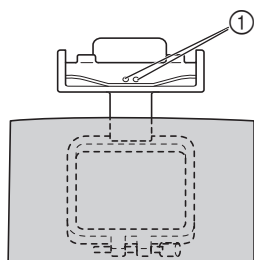

① Screw heads

- Be sure to place the outer frame so that the screw heads on the embroidery frame facing up.

3 Press the inner frame into the outer frame.

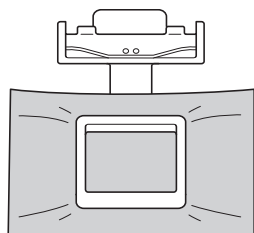

- Be sure that there are no wrinkles in the fabric after it is stretched in the embroidery frame.

4 Securely tighten the screw, and then check that the fabric is taut.

- Using the included screwdriver (large), firmly tighten the screw.

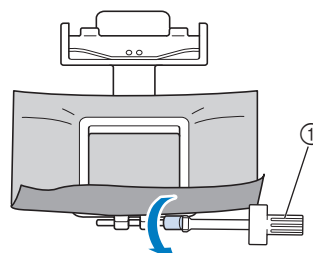

① Screwdriver (large)

5 Use both hands to grasp the frame hooped with the item, and then attach it to embroidery frame holder e.

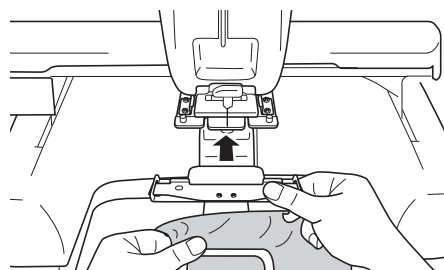

6 Insert the pins on embroidery frame holder e into the holes on both sides of the compact frame to secure it.

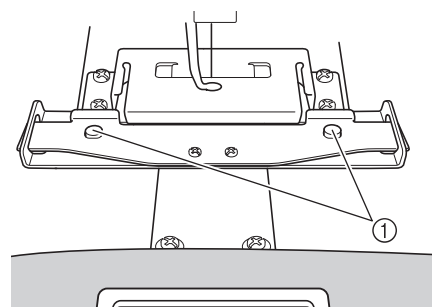

- ① Make sure that the pins on the embroidery frame holder fit into the positioning slot and hole on the embroidery frame.

■ Removing the compact frame

While grasping the compact frame with both hands, lift up both springs with your fingers, and then pull off the compact frame toward you.

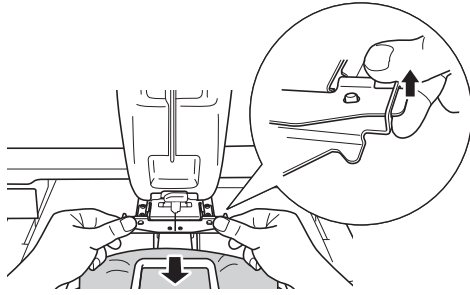

Note

- Be careful not to pinch your fingers with the springs.

Using the embroidery sheet

In order to hoop the fabric so that the pattern will be embroidered in the correct position, use the guidelines on the embroidery sheet to accurately stretch the fabric in the frame.

- 1 With a fabric marker, mark the area of the fabric you want to embroider.

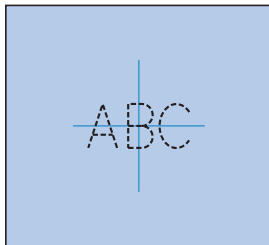

- 2 Place the embroidery sheet on the inner frame. Align the guidelines on the embroidery sheet with the marks that you drew on the fabric.

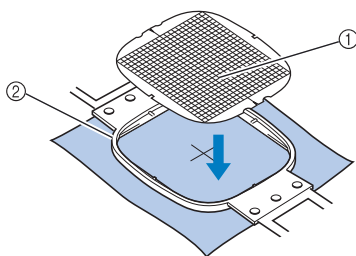

- ① Guidelines
- ② Inner frame

- 3 Gently stretch the fabric, so that there are no folds or wrinkles.

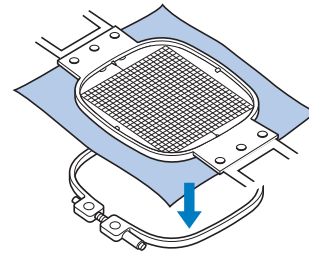

- 4 Press the inner frame into the outer frame. Remove the embroidery sheet.

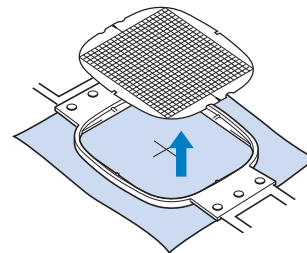

3

Large/small pieces of fabric

This section provides information on embroidering fabric that is either much larger or much smaller than the embroidery frame.

■ Embroidering large pieces of fabric or heavy clothing

When embroidering large pieces of fabric or heavy pieces of clothing, use a clothespin or binder clip to fasten the excess fabric to the embroidery frame so that it does not hang down from the frame.

Embroidering with excess fabric hanging down from the embroidery frame may prevent the frame from moving properly and may result in a misaligned pattern.

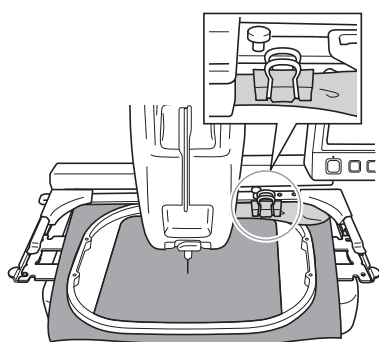

- Use a clothespin or binder clip to fasten the excess fabric to the embroidery frame.

■ Embroidering small pieces of fabric

When embroidering pieces of fabric that are smaller than the embroidery frame, use spray fabric adhesive to attach the fabric to stabilizer (backing) hooped in the embroidery frame. With fabrics where you do not wish to use spray adhesive, baste the fabric to the stabilizer (backing).

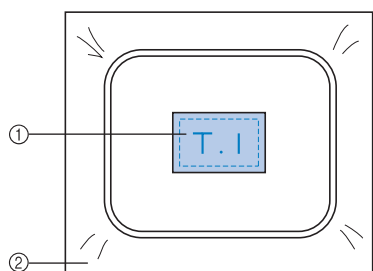

- ① Fabric
- ② Stabilizer (backing)

■ Embroidering the corner of fabric

When embroidering the corner of a piece of fabric, use spray fabric adhesive to attach the corner of the fabric to stabilizer (backing), and then hoop the stabilizer (backing) in the embroidery frame. With fabrics where you do not wish to use spray adhesive, baste the fabric to the stabilizer (backing).

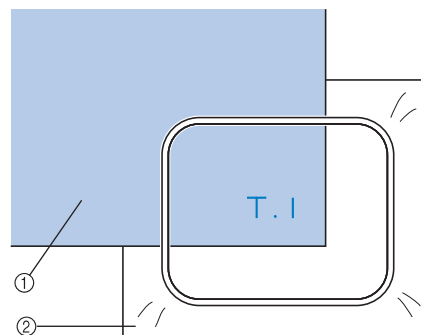

- ① Fabric
- ② Stabilizer (backing)

■ Embroidering narrow pieces of fabric, such as ribbon

When embroidering narrow pieces of fabric, use spray fabric adhesive to attach the fabric to stabilizer (backing), and then hoop the stabilizer (backing) in the embroidery frame. With fabrics where you do not wish to use spray adhesive, clamp both ends of the fabric, together with the stabilizer (backing), in the embroidery frame.

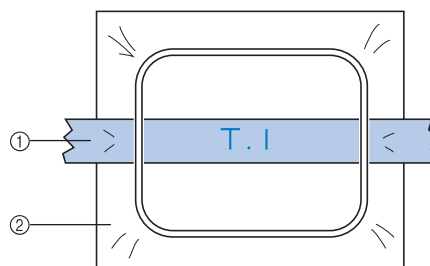

- ① Ribbon
- ② Stabilizer (backing)

Embroidery Frame Position and Movement

The following provides information concerning the embroidery frame when operating the embroidery machine.

■ Embroidery frames that cannot be used for embroidering

As explained on page 42, the embroidery frame indicators at the top of the screen show the embroidery frames that can be used to embroider the currently selected pattern.

Embroidery frames with an embroidering area smaller than the pattern cannot be used. In addition, the embroidery frame cannot be used if the embroidery is smaller than the embroidering area but is positioned so that it extends out of the embroidering area of the frame.

Embroidery frames with an embroidering area smaller than the pattern

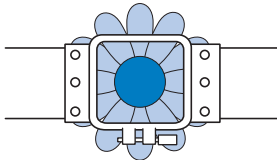

Patterns that extend out of the embroidering area of the frame

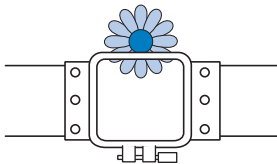

In either of these cases, a message appears on the embroidery machine, warning that the embroidery frame must be changed.

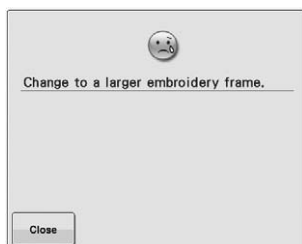

A message indicating that the embroidery frame be replaced may appear even if no embroidery frame is installed.

The embroidery machine detects which embroidery frame is installed according to the position of the left arm of the embroidery frame holder. Therefore, the embroidery frame size is determined by the position of the left arm, even if the embroidery frame is not actually installed.

■ Moving to the correct position

If the center of the embroidery frame is at the needle drop point in the embroidering area, the embroidery frame is correctly positioned, in other words, at the starting position before embroidering.

If the embroidery frame is changed, the next frame that is installed will not be correctly positioned. For example, if the large embroidery frame is replaced with the small frame, the following will occur.

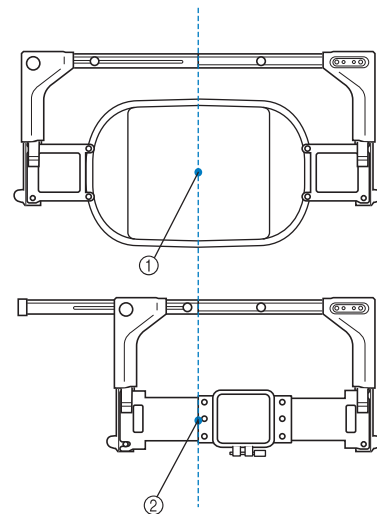

- ① Center of embroidery frame at the correct position
- ② Needle position when the embroidery frame is replaced

In order to correct the misalignment of this embroidery frame, the embroidery frame automatically moves to the correct position when any of the following are performed.

- **The embroidery machine is turned on.**
The embroidery frame will move.
- **The embroidering screen is displayed.**
The embroidery frame will not move if it is correctly positioned.
If the pattern extends out of the embroidering area for the frame, a message appears, indicating that the embroidery frame should be replaced. Either replace the embroidery frame or return to the pattern editing screen and move the embroidering position.

-
- **The embroidery frame is replaced while the pattern editing screen or the embroidering screen is displayed, and then the key for checking the embroidering area, for moving the embroidery frame, or for starting embroidering is touched.**

The embroidery frame will move.

Since the embroidery frame is moved to the correct position and paused, touch the desired key again.

If the pattern extends out of the embroidering area for the frame after the frame is moved, a message appears, indicating that the embroidery frame should be replaced. Either replace the embroidery frame or return to the pattern editing screen and adjust the pattern size or embroidering position.

Changing the Embroidering Position

When the embroidery machine is purchased, it was adjusted so that the beginning of the stitching was from the center of the pattern. Therefore, move the frame and adjust the embroidering position so that the center of the pattern aligns with the needle drop point at the embroidering position. In addition, the angle of the entire pattern can be adjusted if the fabric cannot be hooped evenly within the embroidery frame and the pattern is positioned at an angle on the fabric.

1 Touch in the embroidering settings screen.

Move the embroidery frame so that the needle drop point is at the center of the area where you wish to embroider. The red pointer light indicates the needle drop point when you set the "LED pointer" to "ON" in the settings screen. For details on the settings screen, refer to "Using the Settings Key" on page 142.

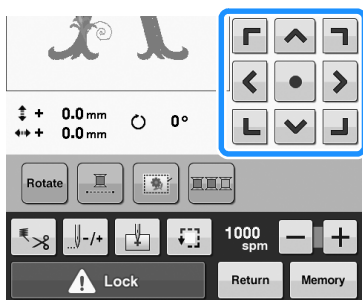

- The embroidery frame moves in the opposite direction of the arrow.
- The pattern in the pattern display area moves in the same direction of the arrow.

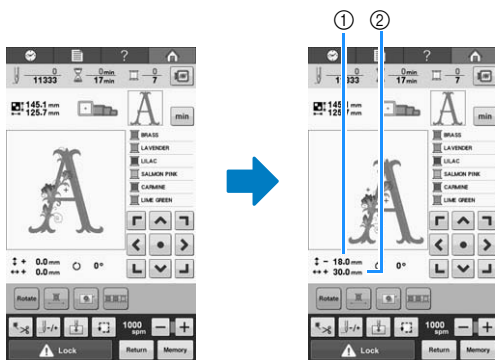

- ① Shows the vertical distance moved
- ② Shows the horizontal distance moved
- Touch to move the embroidery frame back to its original position (where the center of the embroidery frame is aligned with the needle drop point at the embroidering position).

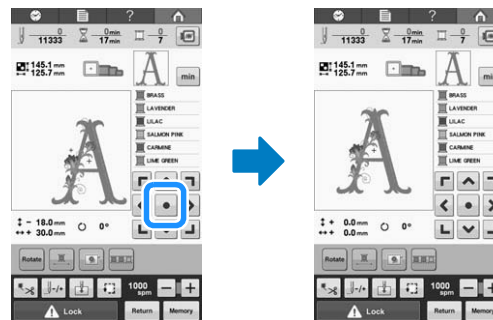

The pattern can also be dragged by selecting it directly in the screen with your finger or the touch pen.

3

Adjusting the angle

Depending on the type of fabric being embroidered, it may not be possible to stretch the fabric in the embroidery frame at the desired angle. In this case, adjust the angle of the pattern so that it is correctly positioned on the fabric.

1 Touch .

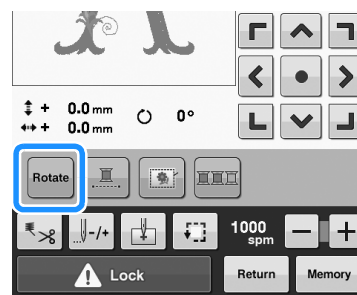

The screen shown below appears.

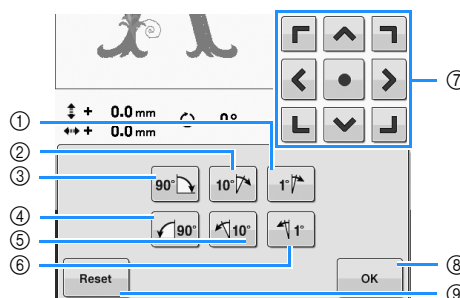

Example: Original angle



- ① Rotates 1 degree to the right
- ② Rotates 10 degrees to the right
- ③ Rotates 90 degrees to the right
- ④ Rotates 90 degrees to the left
- ⑤ Rotates 10 degrees to the left
- ⑥ Rotates 1 degree to the left
- ⑦ Moves the pattern in the direction of the arrow on the key.
- ⑧ Touch this key to close this screen.
- ⑨ Touch this key to return the pattern to its original angle.



2 Touch the keys to adjust the pattern to the desired angle.

Each touch of a key rotates the pattern.

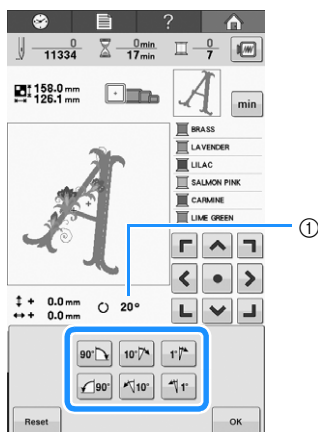

- ① Shows the angle of the pattern after a key is touched to change it.

- To return the pattern to its original angle, touch



3 If necessary, touch the arrow keys to adjust the position of the pattern.

For more details, refer to page 83.

4 If necessary, touch and then touch to check the embroidering area.

For more details, refer to page 46.

Memo

- With this operation, fine adjustments can be made to the angle; also, this operation is particularly useful when embroidering items, such as bags and tubular items, that have limitations to being hooped in the embroidery frame.

Example: When embroidering a pillowcase Rotate the pattern 90 degrees to the left before embroidering.

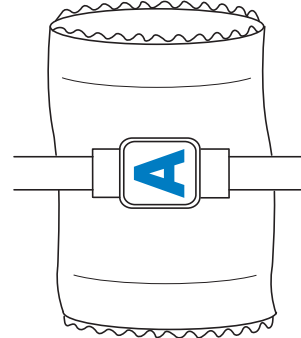

Example: When embroidering a T-shirt Rotate the pattern 180 degrees. Pass the machine bed through from the waist of the T-shirt, not from the neck, and attach the embroidery frame to the machine. This will prevent the neck of the shirt from being stretched when the embroidery frame is moving.



If the Thread Breaks or the Bobbin Thread Runs Out While Embroidering

If the thread breaks or the bobbin thread runs out while embroidering, the machine will automatically stop. Since some stitches may be embroidered with only one thread, go back through the stitching to a point where stitches have already been embroidered before continuing embroidering.



Note

- If the thread sensor is turned off, the machine does not stop until embroidering is finished. Normally, the thread sensor should be turned on. Refer to “Specifying thread sensor” on page 147.
- Be careful when going back or forward through the stitching since the embroidery frame moves at the same time.



If the upper thread breaks

1 Re-thread the upper thread. (Refer to page 48.)

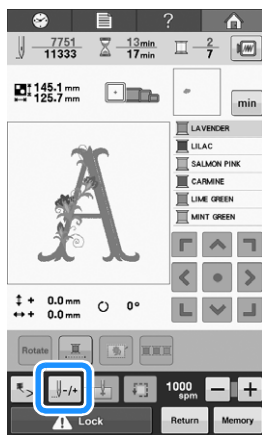
2 Touch .



→ The stitch navigating screen appears.

3 Touch  and  to go back through the stitching to a point where stitches have already been sewn.

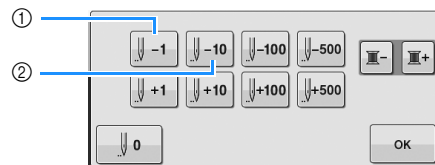



- ① Each touch of this key moves one stitch back through the stitching.
- ② Each touch of this key moves ten stitches back through the stitching.

The embroidery frame moves. Go back to the point where stitches have already been sewn.

The red pointer light indicates the needle drop point when you set the “LED pointer” to “ON” in the settings screen. For details on the settings screen, refer to “Using the Settings Key” on page 142.



If the needle bar is moved back too far through the stitching, touch  or  to go forward through the stitching.

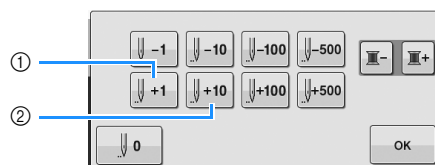

- ① Each touch of this key moves one stitch forward through the stitching.
- ② Each touch of this key moves ten stitches forward through the stitching.

4 Touch .

→ The embroidering screen appears again.

5 Touch , and then press the “Start/Stop” button to continue embroidering.

If the bobbin thread breaks or runs out

- 1 Touch , and then press the thread trimming button.

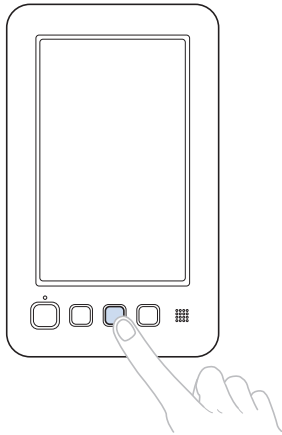

→ The upper thread is trimmed.

- If the bobbin thread breaks or runs out, also trim the upper thread.

- 2 Remove the stitches embroidered only with the upper thread.

Pull the trim end of the upper thread.

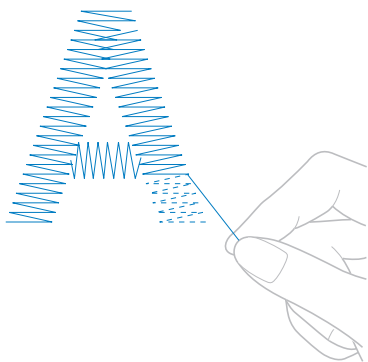

- If the stitches cannot be cleanly removed, trim the thread with scissors.

- 3 If the bobbin thread ran out, replace the bobbin at this point in the procedure.

- 3 Replace the bobbin with a bobbin wound with bobbin thread. (Refer to page 32.)

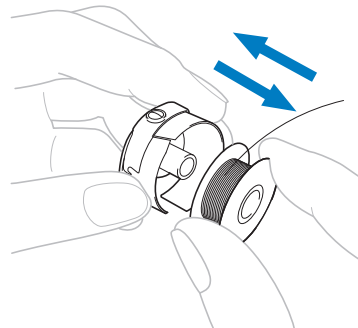

- If the hook cover can be opened, replace the bobbin without removing the embroidery frame from the machine.
- If the machine bed is hidden, for example, with a bag-shaped piece of fabric, or if the hook cover cannot be opened, temporarily remove the embroidery frame. (Refer to page 58.) After replacing the bobbin, re-attach the embroidery frame. (Refer to page 44.)



Note

If the embroidery frame is removed before embroidering of the pattern is finished, be careful of the following, otherwise the pattern may become misaligned.

- Do not apply extreme pressure to the framed fabric and cause it to become loose.
- When removing and re-attaching the embroidery frame, do not allow the frame to hit the carriage or the presser foot. If the carriage is hit and moves, turn the machine off, then on again. The correct frame position at the time that the machine was stopped is stored in the machine's memory, and the embroidery frame is returned to the correct position.
- When the embroidery frame is re-attached, make sure that the pins on the left and right arms of the embroidery frame holder securely fit into the holes in the handles on the embroidery frame.

- 4 Go back through the stitching in the same way as that described in step e of "If the upper thread breaks" on page 85, and then continue embroidering.

Embroidering From the Beginning or Middle of the Pattern

If you wish to restart embroidering from the beginning, for example, if trial embroidery was sewn and an incorrect thread tension was used or if the wrong thread color was used, restart the embroidering using the forward/backward stitch key. In addition, you can go forward or back through the stitching by thread color or by stitch to start stitching at any position of the pattern.



Note

- Be careful when going back or forward through the stitching since the embroidery frame moves at the same time.

- 1 Press the “Start/Stop” button to stop the machine.

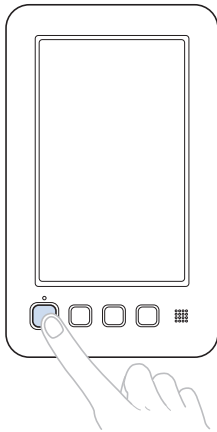

- If necessary, change the fabric framed in the embroidery frame or trim and remove the stitches.

- 2 Touch .

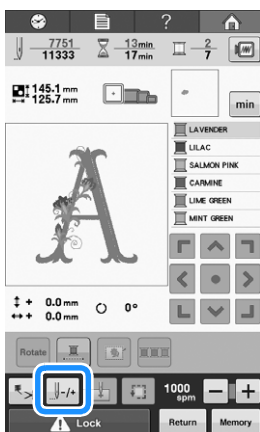

→ The stitch navigating screen appears.





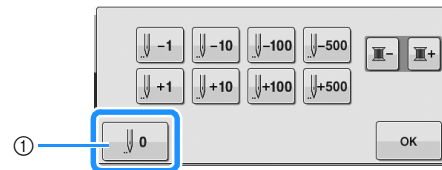





■ To start embroidering from the beginning

- 3 Touch .



- 1 Touch this key to return to the beginning of the first color.
→ The embroidery frame moves to the starting position.

■ To select the stitch from where embroidering is to begin

- 4** Touch  and  to select a color in the thread color sequence, and then touch , , , , , , ,  and  to select the stitch.

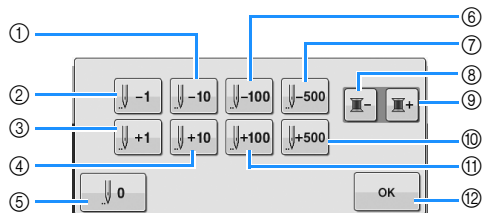

- ① Each touch of this key moves ten stitches back through the stitching.
 - ② Each touch of this key moves one stitch back through the stitching.
 - ③ Each touch of this key moves one stitch forward through the stitching.
 - ④ Each touch of this key moves ten stitches forward through the stitching.
 - ⑤ Touch this key once to return to the beginning of the stitching for the color being embroidered. Afterward, each touch of this key returns to the beginning of embroidering for the previous thread color.
 - ⑥ Each touch of this key moves one hundred stitches back through the stitching.
 - ⑦ Each touch of this key moves five hundred stitches back through the stitching.
 - ⑧ Touch this key once to return to the beginning of the stitching for the color being sewn. Afterward, each touch of this key returns to the beginning of sewing for the previous thread color.
 - ⑨ Each touch of this key advances to the beginning of embroidering the next thread color.
 - ⑩ Each touch of this key moves five hundred stitches forward through the stitching.
 - ⑪ Each touch of this key moves one hundred stitches forward through the stitching.
 - ⑫ Touch this key to close this screen.
- The needle bar moves to the embroidering position, and then the embroidery frame moves and current needle position is indicated.

- 5** After selecting the stitch from where embroidering is to begin, touch .

→ The embroidering screen appears again.

- 6** Touch , and then press the “Start/Stop” button to begin embroidering.

→ Embroidering begins from the specified point.

Resume Embroidering After Turning Off the Machine

In either of the following cases, the remaining stitches of the embroidery are stored in the machine's memory.

- If the machine's power switch is pressed to turn off after stopping embroidering. Cut the thread before the machine's main power switch is turned off, otherwise the thread may be pulled or may catch when the carriage returns to its initial position after the machine is turned on again.
- If the machine was accidentally turned off, for example, due to a power outage, while it was embroidering. The remainder of the embroidery can be sewn when the machine is turned on again; however, some of the stitches that were already sewn may be sewn again.



Note

- Be careful when going back or forward through the stitching since the embroidery frame moves at the same time.

- 1 Set the main power switch to "I" to turn on the machine.

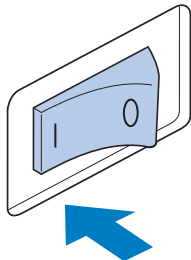

- 2 When the machine is turned on, the opening movie is played. Touch anywhere on the screen to display the message below.

- 3 Touch .

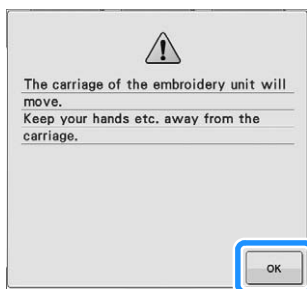

→ A message appears, asking if you wish to continue embroidering or start a new operation.

- 4 Touch .

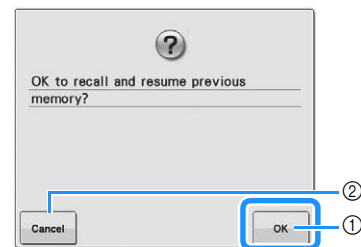

- ① Touch to continue embroidering.
 - ② Touch to cancel embroidering and display the pattern type selection screen to select a new pattern.
- The embroidering screen displayed before the machine was turned off appears.

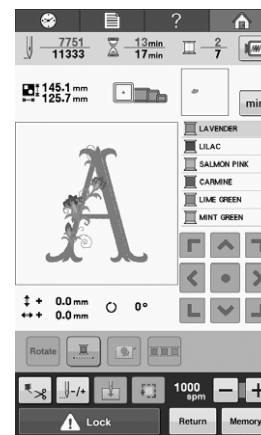

- 5 Touch .

→ The stitch navigating screen appears.

- 6** Touch  two or three times to go back two or three stitches.

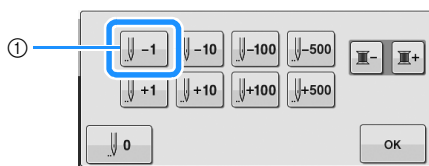

- ① Each touch of this key moves one stitch back through the stitching.
- Check that the red pointer light indicates the needle drop point where stitches have already been done.

- 7** Touch .

→ The embroidering screen appears again.

- 8** Touch , and then press the “Start/Stop” button to continue embroidering.



Memo

- The machine can be stopped at any time, even while it is embroidering; however, if the machine is stopped when the thread color is changed, it is not necessary to go back through the stitching when embroidering is continued.

Adjusting the Thread Tension

The following procedure describes how to adjust the thread tension if the correct thread tension as described on page 57 was not used. After adjusting the tension of the bobbin thread, adjust the tension of the upper thread.



Note

- Be sure to check the tension of the bobbin thread each time that the bobbin is changed. Depending on the bobbin thread type and whether a prewound bobbin is used, the tension of the bobbin thread may differ. For example, when replacing an empty prewound bobbin with one of the same type, be sure to check the tension of the bobbin thread and adjust the tension if necessary.
- Be sure to adjust the tension of the bobbin thread before adjusting the tension of the upper thread.

Adjusting the tension of the bobbin thread

- 1 Tie the included weight to the end of the thread extending from the bobbin case.

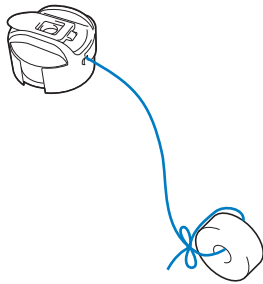

Note

- Different weights are used to adjust prewound bobbins and metal bobbins.
Pre-wound bobbins: Only weight (L)
Metal bobbins: Weight (L) and weight (S)
- If necessary, refer to “Disassembling and cleaning the tension unit” on page 167 for reassembling the tension unit.

- 2 As shown in the illustration, hold the bobbin case against a smooth vertical surface.

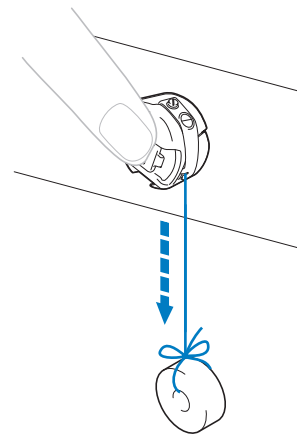

- If the thread with the weight attached is slowly pulled out, the thread tension is correct.

- 3 Use the included standard screwdriver to turn the tension-adjusting screw and adjust the thread tension.

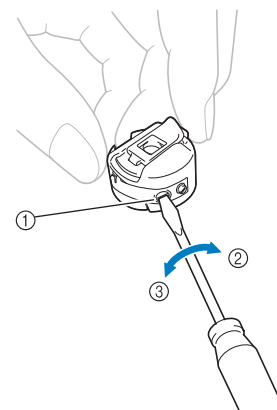

- ① Tension-adjusting screw
- ② Tighter
- ③ Looser

- 4 After making the adjustments, try embroidering to check the thread tension.

Adjusting the tension of the upper thread

When embroidering, the thread tension should be set so that the upper thread can slightly be seen on the wrong side of the fabric.

1 Turn the thread tension knob.

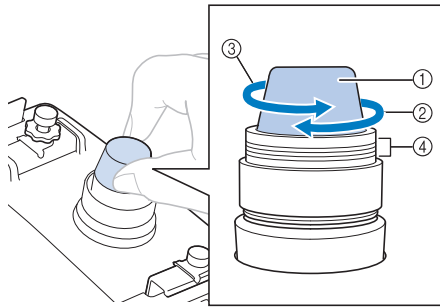

- ① Thread tension knob
- ② Tighter
- ③ Looser
- ④ Mark

→ If the thread tension is not still correctly adjusted, turn the upper thread guide pretension knob.

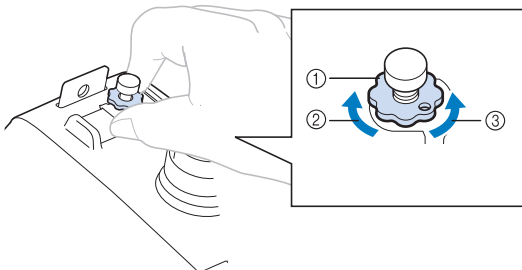

- ① Upper thread guide pretension knob
- ② Tighter
- ③ Looser

Correct thread tension

The pattern can be seen from the wrong side of the fabric. If the thread tension is not set correctly, the pattern will not finish well. The fabric may pucker or the thread may break.



- ① Right side
- ② Wrong side

Follow the operations described below to adjust thread tension according to the situation.



Note

- If the thread tension setting is made extremely weak, the machine may stop during embroidering. This is not the sign of a malfunction. Increase the thread tension slightly, and begin embroidering again.

Upper thread is too tight

The tension of the upper thread is too tight, resulting in the bobbin thread being visible from the right side of the fabric.

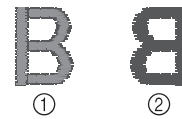

- ① Right side
- ② Wrong side

Turn the knob in the direction of the arrow to decrease the tension of the upper thread.

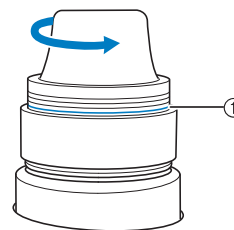

- ① Red line

If the red line is visible, the thread tension cannot be decreased any further. Increase the tension of the bobbin thread. For details, refer to page 91.



Note

- If you decrease the thread tension further than the red line, the tension knob may be disassembled.
- If necessary, refer to “Disassembling and cleaning the tension unit” on page 167 for reassembling the tension unit.

■ Upper thread is too loose

The tension of the upper thread is too loose, resulting in a loose upper thread, loose thread locks or loops appearing on the right side of the fabric.

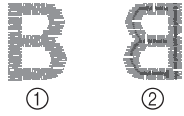

- ① Right side
- ② Wrong side

Turn the knob in the direction of the arrow to increase the tension of the bobbin thread.

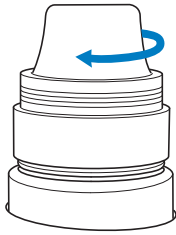

Chapter 4

EMBROIDERING SETTINGS

This chapter contains descriptions on the various embroidering settings, which make operation easier.

Basting Embroidery	96
Starting Position Settings	97
Embroidering linked characters	97
Maximum Embroidering Speed Setting.....	99
Embroidery Color Management.....	100
Uninterrupted embroidering (monochrome - using a single color)	100
Thread color sorting.....	100
Thread Trimming Adjustment.....	101
Using the automatic thread cutting function (End Color Trim)	101
Using the thread trimming function (Jump Stitch Trim).....	101
■ Selecting the length of jump stitch not to trim	102

Basting Embroidery

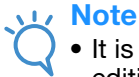

Before embroidering, basting stitches can be sewn along the outline of the pattern. This is useful for embroidering fabric that cannot have stabilizer material affixed with an iron or adhesive. By stitching stabilizer material to the fabric, shrinkage of the stitching or misaligned pattern can be minimized.



Note

- It is recommended to finish combining and editing the pattern before selecting the basting setting. If the pattern is edited after selecting the basting setting, the basting and pattern may become misaligned, and the basting under the pattern may be difficult to remove after embroidering is complete.

1 Touch , and then display page 1 of the settings screen.

2 Use  and  to specify the distance from the pattern to the basting stitching.

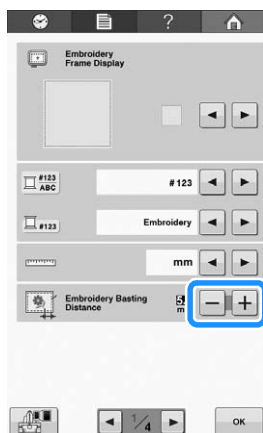

Memo

- The higher the setting, the farther the basting is from the pattern.
- The setting remains selected even if the machine is turned off.

3 Touch  to return to the embroidering screen.

4 Touch  to select the basting setting.

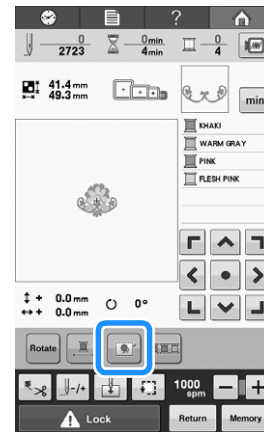

Note

- When  is pressed, the pattern is moved to the center. After selecting the basting setting, move the pattern to the desired position.

- To cancel the setting, touch .
- Basting is added to the beginning of the embroidering order.

5 Touch , and then press the "Start/Stop" button to begin embroidering.

6 When embroidering is finished, remove the basting stitching.

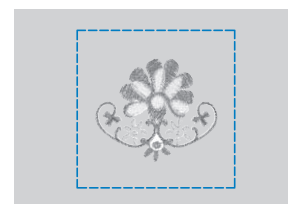

Starting Position Settings

The machine can set the start point from the 9 points of the pattern. Those are upper-left corner, upper-center, upper-right corner, center-left, center-center, center-right, lower-left corner, lower-center and lower-right corner.

These settings can be used to repeatedly embroider a pattern along a diagonal.

The starting position settings are specified from the embroidering settings screen.

When the embroidery machine is purchased, the starting position is set to the center of the pattern.

- 1 Touch .

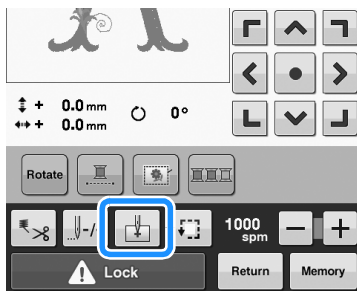

→ The starting position settings screen appears.

- 2 Touch the key for the desired starting position setting.

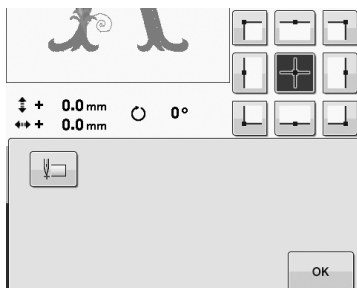

→ The highlighted key shows the currently selected setting.

Example

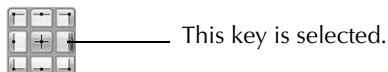

- When a starting position is selected, the ending position is automatically set to the same position.
- The embroidery frame moves to the starting position.

- 3 After selecting the desired settings, touch .

→ The embroidering screen appears again.

Embroidering linked characters

Follow the procedure described below to embroider linked characters in a single row when the pattern extends beyond the embroidery frame.

Example: Linking "DEF" to the characters "ABC"

A B C D E F

- 1 Select the character patterns for "ABC".
- 2 In the embroidering screen, touch .

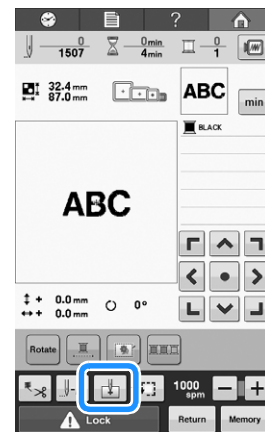

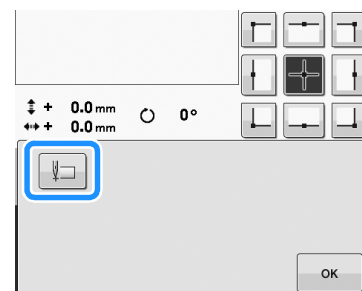

- 3 Touch .





→ The needle bar is positioned in the lower-left corner of the pattern. The embroidery frame moves so that the needle is positioned correctly.



Note

- To cancel the starting point setting and return the starting point to the center of the pattern, touch .
- Use  to select a different starting point for embroidering.

4 Touch  to return to the embroidering screen.

→  changes to  while the starting point is set in the lower-left corner of the pattern.

5 Touch , and then press the “Start/Stop” button to begin embroidering.

6 After the characters are embroidered, cut the threads to a generous length, remove the embroidery frame, and then attach the embroidery frame again so that the remaining characters (“DEF”) can be embroidered.

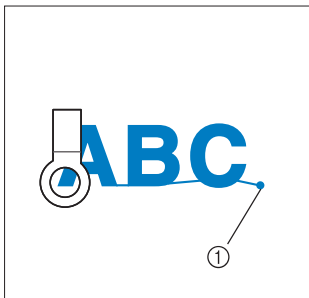

① End of the embroidering

7 As in step ①, select the character patterns for “DEF”.

8 In the embroidering screen, touch .



9 Touch .

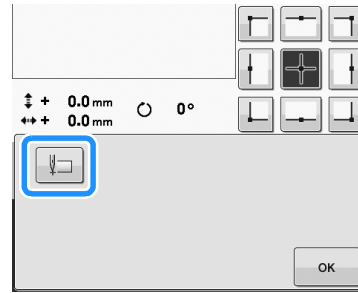

→ The needle bar is positioned in the lower-left corner of the pattern. The embroidery frame moves so that the needle is positioned correctly.

10 Touch .

11 Use  to align the needle with the end of embroidering for the previous pattern.

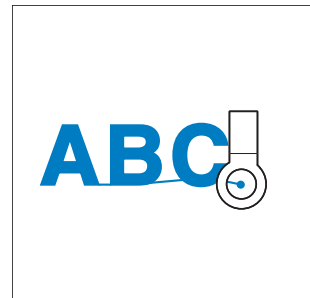

12 Touch , and then press the “Start/Stop” button to begin embroidering the remaining character patterns.



Maximum Embroidering Speed Setting

The maximum embroidering speed can be set to one of seven levels at every 100 spm between 400 and 1000 spm. If the cap frame or the cylinder frame are used, the maximum embroidering speed can be set to one of five levels at every 50 spm between 400 and 600 spm.

Maximum embroidering speed

Embroidery frame/ Flat frame		Cap frame/ Cylinder frame	
1	1000	1	600
2	900	2	550
3	800	3	500
4	700	4	450
5	600	5	400
6	500		
7	400		

The maximum embroidering speed setting is specified from the embroidering screen.

When the embroidery machine is purchased, the maximum embroidering speed is set to 1000 spm (Cap frame for 400 spm).

The cap frame, cylinder frame and flat frame are not included accessories; however, they are available as an option.

- 1** To increase the embroidering speed, touch **+**. To decrease the embroidering speed, touch **-**.

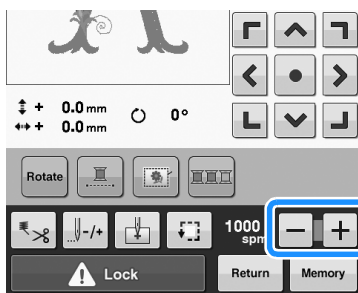



→ The value beside **-** and **+** changes.

Memo

- Decrease the embroidering speed when embroidering on thin, thick or heavy fabrics. In addition, the machine embroiders more quietly at a slower embroidering speed.
- The embroidering speed can be changed while embroidery is being sewn.
- The maximum embroidering speed setting does not change until a new setting is selected. The setting specified before the machine is turned off remains selected the next time that the machine is turned on.
- Decrease the embroidering speed to 400 spm, when using a weak thread like a metallic thread.

Embroidery Color Management

Uninterrupted embroidering (monochrome - using a single color)

A selected pattern can be stitched out in one color instead of multicolor. The machine will hesitate but not stop between color steps, and then continue till the pattern is completed. Touch  for the multicolor steps to become shaded and the selected pattern will embroider in a single color, instead of changing the thread while embroidering. Touch  again to return to the pattern's original settings.

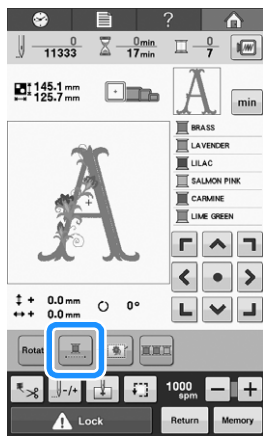

→ The thread color displayed on the screen will be grayed out.

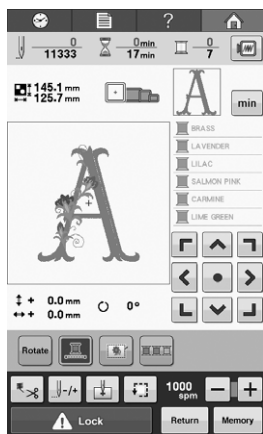



Memo

- Even if uninterrupted embroidering has been set, the automatic thread cutting function and the thread trimming function can be used (refer to page 101).
- After finishing the embroidery, uninterrupted embroidery will be canceled.

Thread color sorting

You can embroider while replacing the thread spool a minimal number of times.

Before starting to embroider, touch  to rearrange the embroidery order and sort it by thread colors. Touch  to cancel the color sorting and embroider with the embroidery color order.

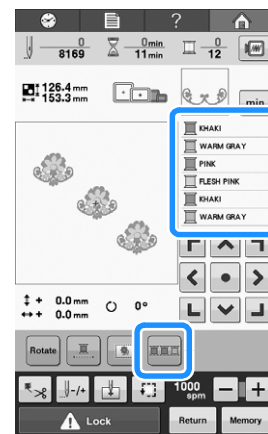

→ The embroidery color order is rearranged and sorted by thread colors.

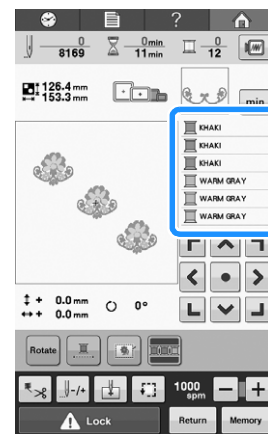





Note

- The thread color sorting function cannot be used with overlapping patterns.

Thread Trimming Adjustment

Using the automatic thread cutting function (End Color Trim)

The automatic thread cutting function  will cut the thread at the end of embroidering each color. This function is initially turned on. To turn this function off, touch  and then . This function can be turned on or off during embroidering.

- This setting returns to its default  when the machine is turned off.

1 Touch .

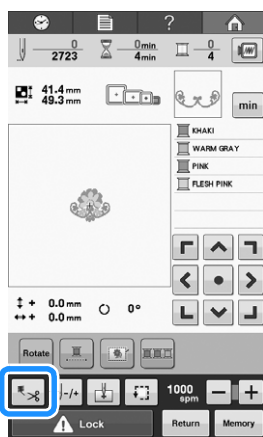

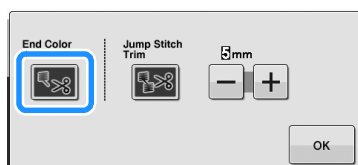

2 Touch  to turn off the automatic thread cutting function.



- The key will display as .
- When one color thread is embroidered, the machine will stop without cutting the thread.

Using the thread trimming function (Jump Stitch Trim)

The thread trimming function  will automatically trim any excess thread jumps within the color. This function is initially turned on. To turn this function off, touch  and then . This function can be turned on or off during embroidering.

- Your customized setting remains after turning the machine off and on.

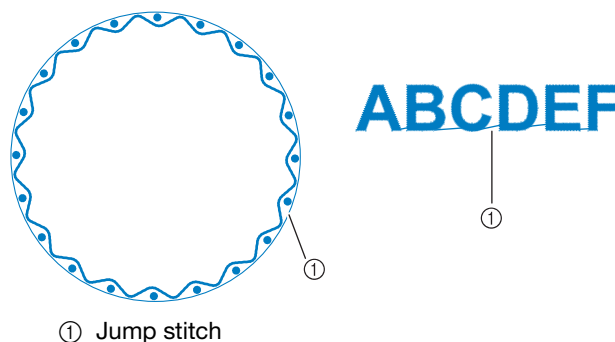

① Jump stitch



Note

- When this function is turned on, use the included ball point needle 75/11 for embroidering patterns with short jump stitches such as alphabet characters. Using other needles may cause the thread to break.

1 Touch .

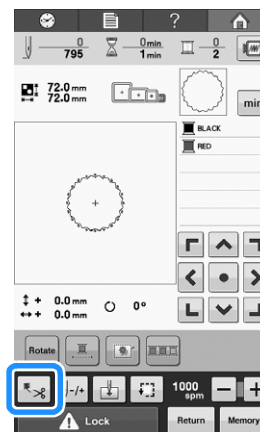

- 2 Touch  to turn off the thread trimming function.

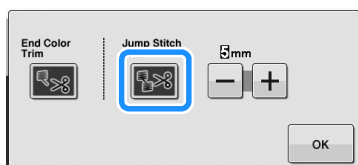



- The key will display as .
- The machine will not trim the thread before moving to the next stitching.

■ Selecting the length of jump stitch not to trim

When the thread trimming function  is turned on, you can select the length of the jump stitch not to trim the thread. This function can be turned on or off during embroidering.

Select a setting from 5 mm to 50 mm in 5 mm increments.

- Your customized setting remains after turning the machine off and on.

Touch  or  to select the length of jump stitch.

For example: Touch  to select 25 mm (1 inch) and the machine will not trim a jump stitch of 25 mm or less before moving to the next stitching.

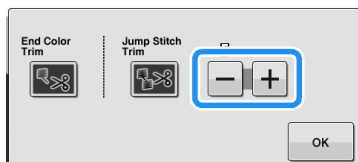

Note

- If pattern has many trims it is recommended to select a higher jump stitch trim setting in order to reduce the amount of excess tails on backside of fabric.
- The higher number of the jump stitch length selected, the fewer number of times the machine will trim. In this case, more jump stitches remain on the surface of the fabric.

Chapter 5

SELECTING/EDITING/ SAVING PATTERNS

This chapter provides details on selecting, editing and saving embroidery patterns.

Using the Memory Function 104

Embroidery data precautions	104
■ Types of embroidery data that can be used	104
■ Types of USB devices/media that can be used.....	104
■ Connecting your machine to the PC.....	104
■ Precautions on using the computer to create and save data...	105
■ Tajima (.dst) embroidery data	105
Concerning optional embroidery cards.....	105
Concerning USB media	105

Selecting an Embroidery Pattern 106

General pattern selection.....	106
■ Pattern type selection screen.....	106
■ Pattern list screen.....	106
Embroidery patterns/ Decorative alphabet patterns	107
Frame patterns	107
Alphabet patterns.....	108
■ Changing the text arrangement	111
■ Changing the text alignment.....	111
Embroidery cards (optional).....	112
■ About embroidery cards (optional)	112
■ About embroidery card reader (optional) and USB card writer module*	112
■ Using embroidery card reader.....	112
Saving embroidery patterns in the machine's memory.....	113
■ If the memory is full	113
Saving embroidery patterns to USB media.....	114
Saving embroidery patterns in the computer	114
Retrieving patterns from the machine's memory.....	115
Recalling from USB media	116
Recalling from the computer.....	117

Editing the Embroidery Pattern (Pattern Editing Screen)..... 119

Combining patterns.....	119
Selecting the pattern to be edited	120
Displaying the enlarged pattern image.....	120
Moving a pattern.....	121
Flipping a pattern horizontally.....	121
Changing the size of a pattern.....	122
Rotating a pattern	123
Changing the text arrangement of a character	124
Changing the character spacing	124
Separating combined character patterns.....	125
Changing the thread density (only for some character and frame patterns)	126
■ Reduces thread density.....	126
■ Increases thread density	126
Specifying multi-color text	126
Changing the colors of the pattern.....	127
Designing repeated patterns	128
■ Embroidering repeated patterns	128
■ Repeating one element of a repeated pattern.....	130
■ Assigning thread marks.....	131
Creating a custom thread table	132
■ Adding a color to the custom thread table from the list.....	133

■ Saving the Custom Thread Table to USB media	133
■ Recalling the Custom Thread Table data from USB media.....	134
Choosing a color from the custom thread table	135
Duplicating a pattern	136
Deleting a pattern	136

Editing the Embroidery Pattern (Embroidering Screen)..... 137

Rotating the entire pattern	137
Editing a Combined Pattern.....	138

Using the Memory Function

Embroidery data precautions

Observe the following precautions when using embroidery data other than that created and saved in this machine.

CAUTION

- When using embroidery data other than our original patterns, the thread or needle may break when sewing with a stitch density that is too fine or when sewing three or more overlapping stitches. In that case, use one of our original data design systems to edit the embroidery data.

■ Types of embroidery data that can be used

- Only .pes, .phc and .dst embroidery data files can be used with this machine. Using data other than that saved using our data design systems or embroidery machines may cause the embroidery machine to malfunction.

■ Types of USB devices/media that can be used

Stitch data can be saved to or recalled from USB media. Use media that meets the following specifications.

- USB Flash drive (USB Flash memory)
- USB Floppy disk drive

Stitch data can be recalled only.

- USB CD-ROM, CD-R, CD-RW drives

You can also use the following types of USB media with USB Memory Card Reader/USB card writer module.

- Secure Digital (SD) Card
- CompactFlash
- Memory Stick
- Smart Media
- Multi Media Card (MMC)
- xD-Picture Card



Note

- The processing speed may vary by port selection and quantity of data stored.
- Some USB media may not be usable with this machine. Please visit our website (<http://support.brother.com>) for more details.
- The access lamp will begin blinking after inserting USB devices/media, and it will take about 5 to 6 seconds to recognize the devices/media. (Time will differ depending on the USB device/media).



Memo

- To create file folders, use a computer.
- Letters and numerals can be used in the file names. In addition, if the file name contains no more than eight characters, the entire file name will appear on the screen. If the file name is more than eight characters long, only the first six characters followed by “~” and a number appear as the file name.

■ Connecting your machine to the PC

- Compatible models:
 - IBM PC with a USB port as standard equipment
 - IBM PC-compatible computer equipped with a USB port as standard equipment
- Compatible operating systems:
 - Microsoft Windows XP, Windows Vista, Windows 7, Windows 8

■ Precautions on using the computer to create and save data

- If the name of the embroidery data file/folder cannot be identified, for example, because the name contains special characters, the file/folder is not displayed. If this occurs, change the name of the file/folder. We recommend using the 26 letters of the alphabet (uppercase and lowercase), the numbers 0 through 9, "-", and "_".
- Embroidery data larger than 200 mm (H) × 200 mm (W) (approx. 7-7/8 inches (H) × 7-7/8 inches (W)) cannot be used. (All patterns must be within the 200 mm (H) × 200 mm (W) (approx. 7-7/8 inches (H) × 7-7/8 inches (W)) pattern field size.)
- .pes files saved with the number of stitches or the number of colors exceeding the specified limits cannot be displayed. The combined pattern can not exceed a maximum number of 500,000 stitches or a maximum number of 127 color changes (Above numbers are approximate, depending on the overall size of the pattern). Use one of our pattern software programs to edit the embroidery pattern so that it meets these specifications.
- Embroidery data stored in a folder created in USB media can be retrieved.
- Do not create folders in "Removable Disk" on a computer. If embroidery data is stored in a folder in "Removable Disk", that embroidery data cannot be retrieved by the machine.
- Even if the embroidery unit is not attached, the machine will recognize embroidery data.

■ Tajima (.dst) embroidery data

- dst data is displayed in the pattern list screen by file name (the actual image cannot be displayed). Only the first eight characters of the file name can be displayed.
- Since Tajima (.dst) data does not contain specific thread color information, it is displayed with our default thread color sequence. Check the preview and change the thread colors as desired.

Concerning optional embroidery cards

- Do not disassemble or alter the embroidery cards.
- Do not forcefully bend, drop, scratch or place heavy objects on top of the embroidery cards.
- Do not allow the embroidery cards to become wet, such as with water, solvents, drinks or any other liquids.
- Do not use or store the embroidery cards in a location exposed to strong static electricity or electrical interference.
- Do not use or store embroidery cards in locations exposed to vibrations or impacts, direct sunlight, extreme dust (or lint), high temperatures, high humidity, severe temperature fluctuations, or strong magnetic forces (such as from speakers).
- To use optional embroidery cards to recall embroidery patterns, connect the embroidery card reader/USB card writer module* to this machine.
- Store embroidery cards in their protective cases.
- If an embroidery card other than our original embroidery cards are used, the embroidery machine may not operate correctly. Be sure to use only recommended embroidery cards.
- Some licensed or copyright embroidery cards cannot be used with this embroidery machine.
- Embroidery cards sold overseas cannot be used with this embroidery machine.
- Only insert or remove embroidery cards while an access lamp on the embroidery card reader/USB card writer module* is not flashing, or while the embroidery machine is turned off (refer to "Embroidery cards (optional)" on page 112).

* If you have purchased the PE-DESIGN Ver5 or later, PE-DESIGN NEXT, PE-DESIGN Lite or PED-BASIC, you can plug the included USB card writer module into the machine as an embroidery card reader, and recall patterns.

Concerning USB media

- Do not disassemble or alter the USB media.
- Do not allow the USB media to become wet, such as with water, solvents, drinks or any other liquids.
- Do not use or store the USB media in a location exposed to strong static electricity or electrical interference.
- Do not use or store USB media in locations exposed to vibrations or impacts, direct sunlight, extreme dust (or lint), high temperatures, high humidity, severe temperature fluctuations, or strong magnetic forces (such as from speakers).
- While embroidery data is being recalled from the USB media, do not allow the machine to be exposed to vibrations or impacts, and do not attempt to remove the USB media from the machine.
- Some USB media may not be usable with this machine. Please visit our web site for more details.
- Only remove USB media while an access lamp on the USB media is not flashing (refer to "Saving embroidery patterns to USB media" on page 114).
- For additional information, refer to the instruction manual included with the USB media that you have purchased.
- Do not unplug a USB device/media from this machine immediately after it has been plugged in. Be sure to wait at least 5 seconds before unplugging the USB device/media.

Selecting an Embroidery Pattern

Various embroidery patterns are built into this machine. Other than the built-in patterns, various other patterns can be selected from embroidery cards (optional) and from the computer.

Memo

- Refer to page 112 about recalling the embroidery pattern from the embroidery cards (optional).

General pattern selection

The procedure for selecting a pattern differs depending on the type of pattern; however, the general procedure for selecting a pattern is described below.

- 1 In the pattern type selection screen, touch the key for the desired category.

■ Pattern type selection screen

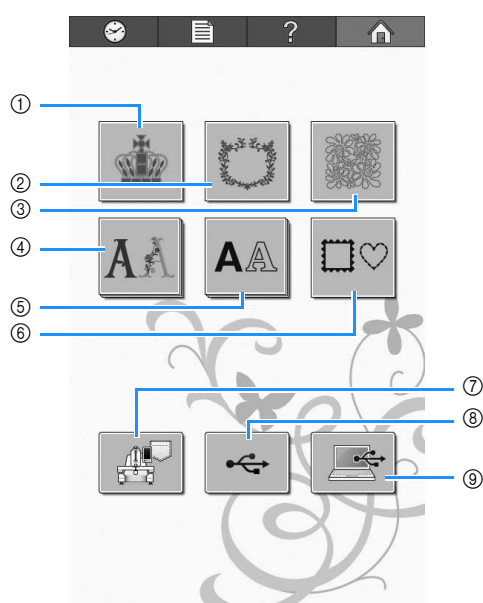



- ① Embroidery patterns
- ② Decoration/Hallmark patterns
- ③ Quilt design patterns
- ④ Decorative alphabet patterns
- ⑤ Alphabet patterns
- ⑥ Frame patterns
- ⑦ Embroidery patterns stored in the machine's memory
- ⑧ USB media
- ⑨ Computer (USB)

- 2 In the pattern list screen, which appears next, touch the desired pattern to select it.

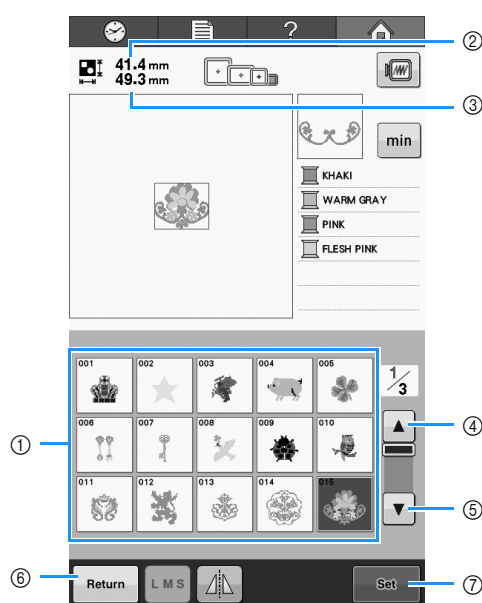
■ Pattern list screen



- ① Pattern keys
 - Touch a pattern to display the following information of the pattern.
- ② Vertical length of the pattern
- ③ Horizontal width of the pattern
- ④  Page up
- ⑤  Page down
 - If there is more than one page, touch ④ and ⑤ until the desired page is displayed.
- ⑥ Return key
 - To return to the pattern type selection screen.
- ⑦ Set key
 - Touch after selecting the pattern. The selection of the pattern is confirmed and the pattern editing screen appears.

Embroidery patterns/ Decorative alphabet patterns

- 1 Select the pattern category you want to embroider.



→ The types of embroidery patterns appear.

- 2 Select a type of pattern.

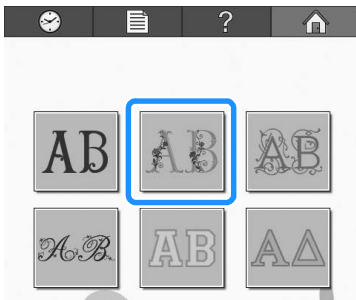

→ The list of embroidery patterns appears.

- 3 Select an embroidery pattern.
Touch the desired pattern.

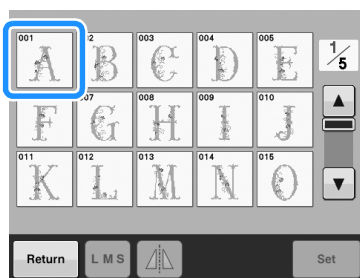

→ The selected pattern appears in the pattern display area.

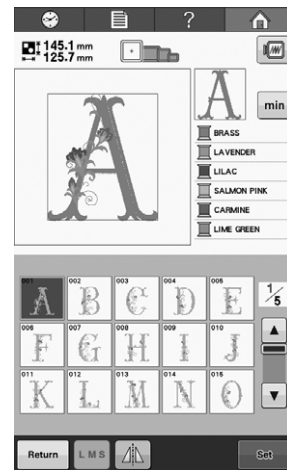

- If the wrong pattern was selected or you wish to select a different pattern, touch the desired pattern.

- 4 Touch **Set**.

This confirms the pattern selection.

→ The pattern editing screen appears.

Frame patterns

- 1 Touch .

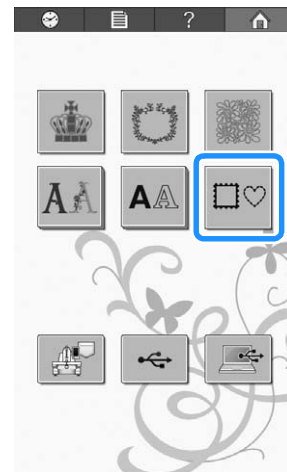

→ The list of frame patterns appears.

2 From the upper tabs of the screen, select the desired shape for the frame.

Touch the desired frame shape.

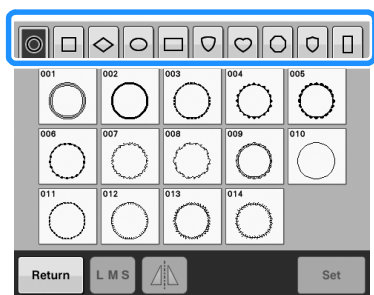

→ The available frame patterns appear in the lower half of the screen.

3 Select a frame pattern.

Touch the desired pattern.

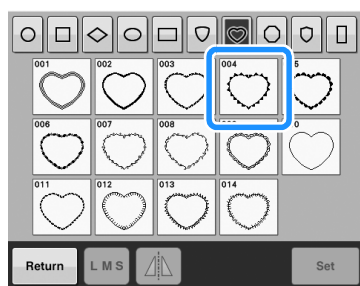

→ The selected pattern appears in the pattern display area.

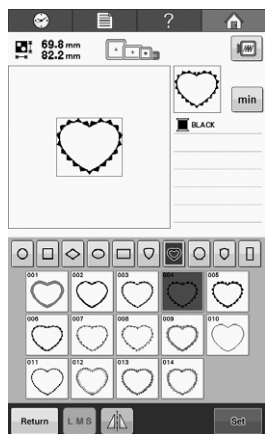

• If the wrong pattern was selected or you wish to select a different pattern, touch the desired pattern.

4 Touch .

This confirms the pattern selection.

→ The pattern editing screen appears.

Alphabet patterns

There are 20 built-in character fonts.

Example: Entering "Lucky Color".

1 Touch .

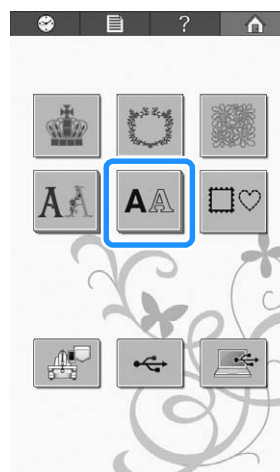



→ The font selection screen appears.

2 Select a character font.

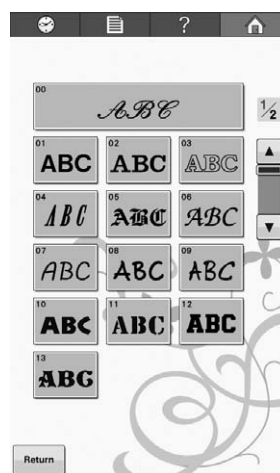
Touch the desired character font.



• Touch  or  for additional selections.

→ The text input screen appears.

- 3 If the key for the character that you wish to select is not displayed, touch the tab for the desired set of characters.

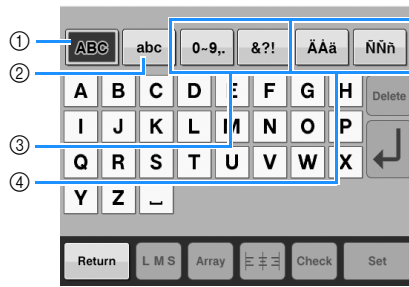

- ① Uppercase letters
- ② Lowercase letters
- ③ Numbers/symbols
- ④ Accented characters

→ The text input screen for the characters shown on the tab appears.

- To change the character font, touch to return to the font selection screen.

- 4 Enter “L”.



- 5 With the first character entered, touch to change the size of the character.

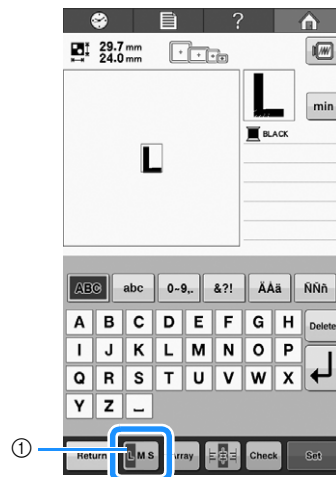

- ① Touch this key to change the size.

- The next characters that are selected will have the new character size.
- The character size of all entered characters cannot be changed after the characters are combined. (The size of the entire pattern can be changed from the pattern editing screen.)



Note

- Size of the four small fonts and cannot be changed.

- 6 Touch and enter “ucky”.

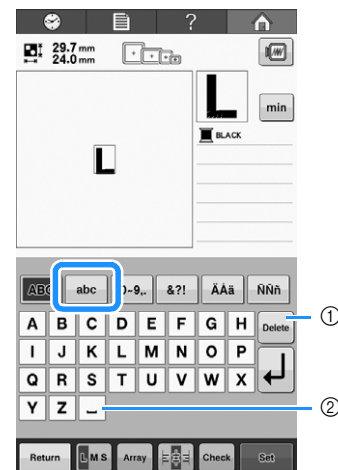

- ① If the wrong character was selected or you wish to select a different character, touch to delete the last character selected, and then touch the key for the desired character. Each touch of deletes the last character of the text.
- ② Touch to enter a space.

7 Touch  to enter a line feed.



8 Touch  and enter "C".



9 Touch  and enter "olor".



10 If the text is small and difficult to read on the screen, touch  to check the text.





11 After checking the text, touch  to return to the text input screen.

12 After entering all of the text as desired, touch .

This confirms the pattern selection.
→ The pattern editing screen appears.

■ Changing the text arrangement

Touch  to display the screen shown below.
Touch the key for the desired text arrangement.
After selecting the desired text arrangement, touch  to return to the text input screen.

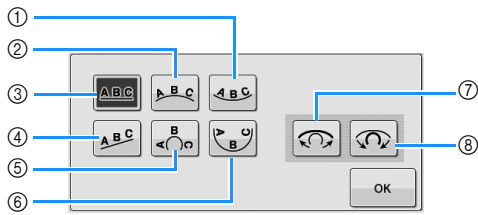

- ① Arranges the text on the inside of a wide curve.
 - ② Arranges the text on the outside of a wide curve.
 - ③ Arranges the text on a straight line.
 - ④ Arranges the text on a slanted line.
 - ⑤ Arranges the text on the outside of a sharp curve.
 - ⑥ Arranges the text on the inside of a sharp curve.
 - ⑦ If text is arranged on a curve, each touch of this key decreases the bend of the curve (makes it flatter).
 - ⑧ If text is arranged on a curve, each touch of this key increases the bend of the curve (makes it more curved).
- If the text is arranged using one of the text arrangements on this screen, even more characters can be entered.

■ Changing the text alignment

Touch  to change the alignment of the text.

When the key displayed as , text is aligned to the left.



When the key displayed as , text is aligned to the center.



When the key displayed as , text is aligned to the right.

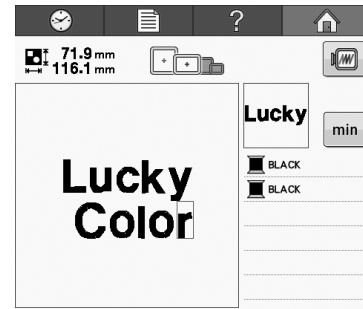

Memo

- The color of the text is set to black. To change the color, refer to “Specifying multi-color text” on page 126 and “Changing the colors of the pattern” on page 127.

Embroidery cards (optional)

■ About embroidery cards (optional)

- Use only embroidery cards manufactured for this machine. Using unauthorized cards may cause your machine to operate incorrectly.
- Embroidery cards sold in foreign countries cannot be used with this machine.
- Store embroidery cards in the hard case.

■ About embroidery card reader (optional) and USB card writer module*

- Use only an embroidery card Reader designed for this machine. Using an unauthorized embroidery card Reader may cause your machine to operate incorrectly.



Note

- Embroidery patterns cannot be saved from the machine to an embroidery card inserted into a connected USB card writer module*.

- * If you have purchased the PE-DESIGN Ver5 or later, PE-DESIGN NEXT, PE-DESIGN Lite or PED-BASIC, you can plug the included USB card writer module into the machine as an embroidery card reader, and recall patterns.

■ Using embroidery card reader

- 1** Plug the optional embroidery card reader/USB card writer module* into the USB port on the machine.

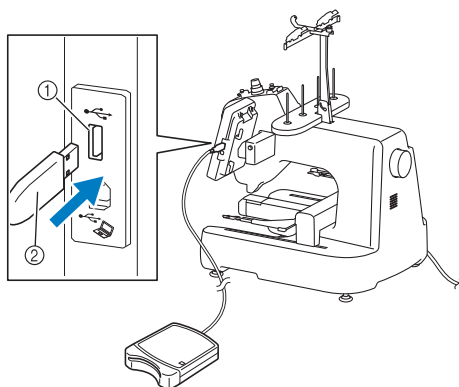

- ① USB port
- ② Embroidery card reader/USB card writer module*

- * If you have purchased the PE-DESIGN Ver5 or later, PE-DESIGN NEXT, PE-DESIGN Lite or PED-BASIC, you can plug the included USB card writer module into the machine as an embroidery card reader, and recall patterns.

When connecting the USB card reader/writer to the machine's USB port, be sure to secure the cable with the two hooks on the back panel. If the cable is not secured, the embroidery frame may catch on the cable while the frame is moving, causing the pattern to become misaligned.

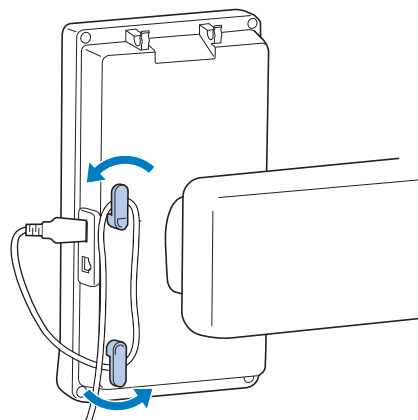

- 2** Insert the card completely into the card reader/USB card writer module*.

- * Insert the embroidery card so that the end with a printed arrow is facing up.

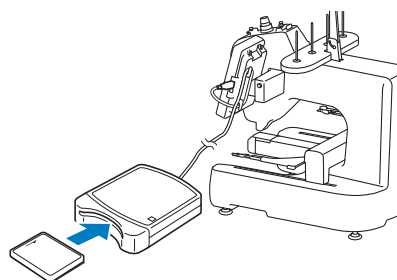

Note

- If an embroidery card other than our original embroidery cards are used, the embroidery machine may not operate correctly. Be sure to use only recommended embroidery cards.
- Some licensed or copyright cards may not be compatible with this embroidery machine.

- 3 Touch the key of the USB port that the embroidery card reader/USB card writer module* is plugged into.

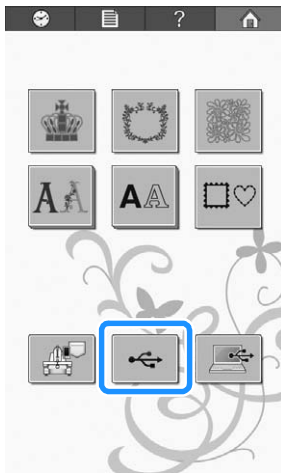

→ The list of patterns on the embroidery card appears.

- 4 Select the pattern as described on pages 107 to 108.

Saving embroidery patterns in the machine's memory

You can save embroidery patterns that you have customized and will use often; for example, your name, patterns that have been rotated or had the size changed, patterns that have had the embroidering position changed, etc. A total of about 1 MB of patterns can be saved in the machine's memory.



Note

- Do not turn the main power to OFF while the "Saving..." screen is displayed. You will lose the pattern you are saving.



Memo

- It takes a few seconds to save a pattern to the machine's memory.
- See page 115 for information on retrieving a saved pattern.

- 1 Touch **Memory** when the pattern you want to save is in the embroidering screen.

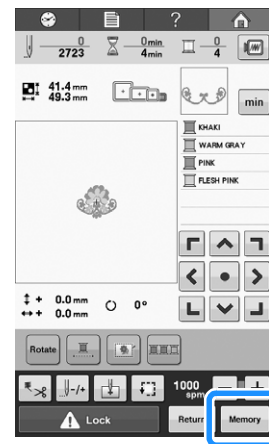

- 2 Touch .

- * Touch **Cancel** to return to the original screen without saving.

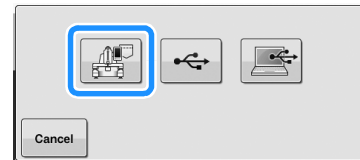

→ The "Saving..." screen is displayed. When the pattern is saved, the display returns to the original screen automatically.

■ If the memory is full

If the screen below displays, either the maximum number of patterns have been saved or the pattern you want to save takes a lot of memory, and the machine cannot save it. Press **OK** and delete a previously saved pattern, then you can save the current pattern. Refer to "Retrieving patterns from the machine's memory" on page 115.

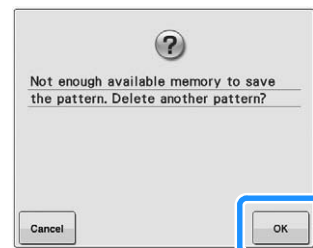

Saving embroidery patterns to USB media

When sending embroidery patterns from the machine to USB media, plug the USB media into the machine's USB port.

Memo

- USB media is commercially available, but some USB media may not be usable with this machine. Please visit our website (<http://support.brother.com>) for more details.
- Depending on the type of USB media being used, either directly plug the USB device into the machine's USB port or plug the USB media Reader/Writer into the machine's USB port.
- The USB media can be inserted or removed at any time.

- 1 Touch **Memory** when the pattern you want to save is in the embroidering screen.

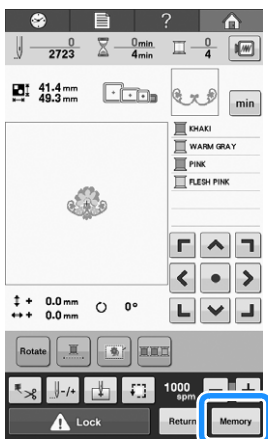

- 2 Insert the USB media into the USB port on the machine.

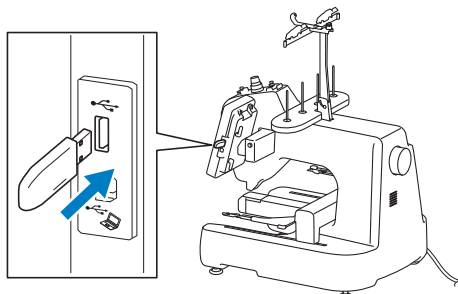

- 1 USB port
- 2 USB media

Note

- Do not insert anything other than USB media into the USB media port. Otherwise, the USB media drive may be damaged.

- 3 Touch .

- * Touch **Cancel** to return to the original screen without saving.

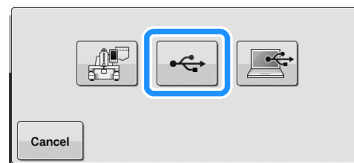

- The "Saving..." screen is displayed. When the pattern is saved, the display returns to the original screen automatically.

Note

- Do not insert or remove USB media while "Saving..." screen is displayed. You will lose some or all of the pattern you are saving.

Saving embroidery patterns in the computer

Using the included USB cable, the machine can be connected to your computer, and the embroidery patterns can be temporarily retrieved from and saved in the "Removable Disk" folder in your computer. An approximate of 772 KB of embroidery patterns can be saved in the "Removable Disk", but the saved embroidery patterns are deleted when the machine is turned OFF.

For Computers and Operating Systems, refer to "Recalling from the computer" on page 117.

Note

- Do not turn the main power to OFF while the "Saving..." screen is displayed. You will lose the pattern you are saving.

1 Plug the USB cable connector into the corresponding USB ports for the computer and for the machine.

- * The USB cable can be plugged into the USB ports on the computer and embroidery machine whether or not they are turned on.

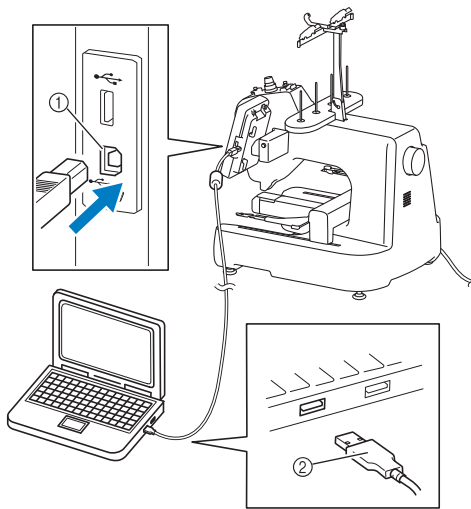

- ① USB port for computer
 - ② USB cable connector
- The "Removable Disk" icon will appear in "Computer (My Computer)" on the computer.



Note

- The connectors on the USB cable can only be inserted into a port in one direction. If it is difficult to insert the connector, do not insert it with force. Check the orientation of the connector.
- For details on the position of the USB port on the computer (or USB hub), refer to the instruction manual for the corresponding equipment.

2 Turn on your computer and select "Computer (My Computer)".

3 Touch **Memory** when the pattern you want to save is in the embroidering screen.

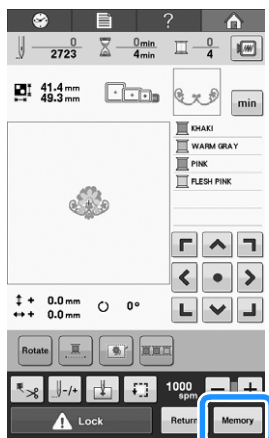

4 Touch .

- * Touch **Cancel** to return to the original screen without saving.



- The pattern will be temporarily saved to "Removable Disk" under "Computer (My Computer)".

5 Select the pattern's .phc file in "Removable Disk" and copy the file to the computer.

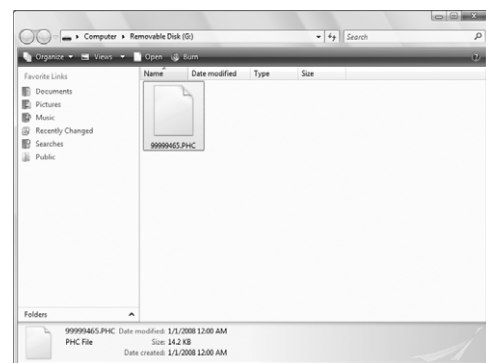

Retrieving patterns from the machine's memory

1 Press .

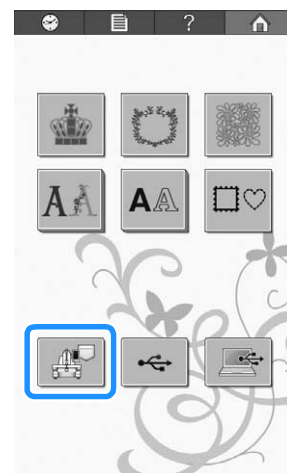

- The machine displays the patterns currently in the memory.

- 2 Touch the key of the pattern you want to retrieve.

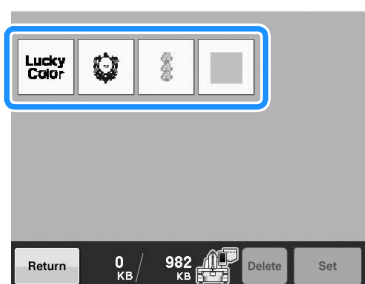

- 3 Touch **Set**.

* Touch **Delete** to delete the embroidery pattern.

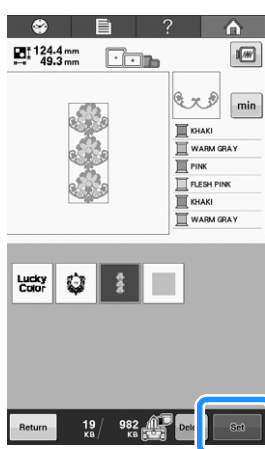

→ The embroidering screen is displayed.

Recalling from USB media

You can recall a specific embroidery pattern from either direct USB media or a folder in the USB media. If the pattern is in a folder, check each folder to find the embroidery pattern.



Note

- The processing speed may vary by quantity of data.

- 1 Insert the USB media into the USB port on the machine.

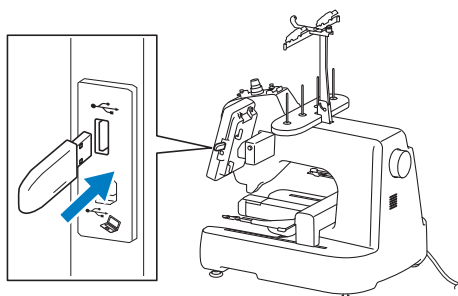

- ① USB port
② USB media

- 2 Touch .

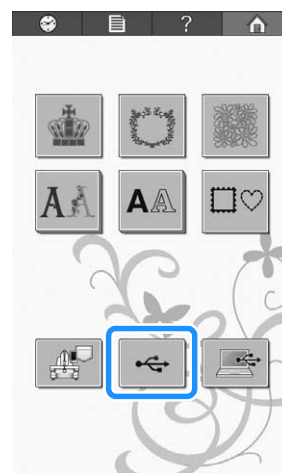

→ Embroidery patterns and a folder in a top folder are displayed.

- 3 Touch  when there is a subfolder to sort two or more stitch patterns to USB media, the embroidery pattern in the subfolder is displayed.

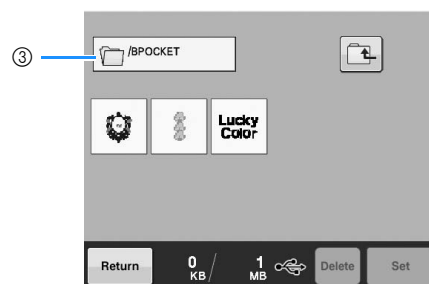
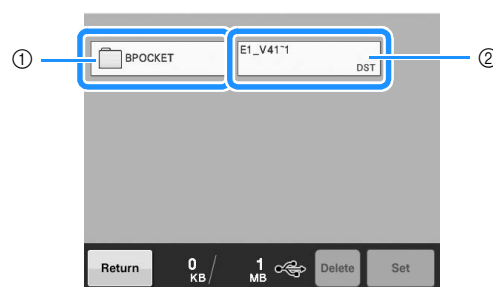

- ① Folder name
② Embroidery patterns in USB media
③ Path
- * The path to show the current folder at the top of the list.
 - * Embroidery patterns and subfolders within a folder are displayed.
 - * Press  to return to the previous folder.
 - * Use the computer to create folders. Folders cannot be created with the machine.

4 Touch the key of the pattern you want to retrieve.

- * Touch **Return** to return to the original screen.

5 Touch **Set**.

- * Touch **Delete** to delete the pattern from the USB media.

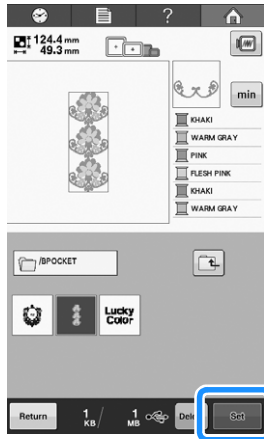

→ The Embroidery Edit screen is displayed.

Recalling from the computer

Refer to “Connecting your machine to the PC” on page 104 for the available computer operating systems.

1 Plug the USB cable connector into the corresponding USB ports for the computer and for the machine. (Refer to “Saving embroidery patterns to USB media” on page 114.)

2 On the computer, open “Computer (My Computer)” then go to “Removable Disk”.

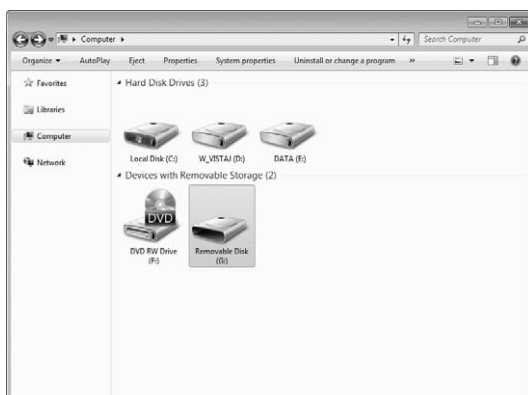

3 Move/copy the pattern data to “Removable Disk”.

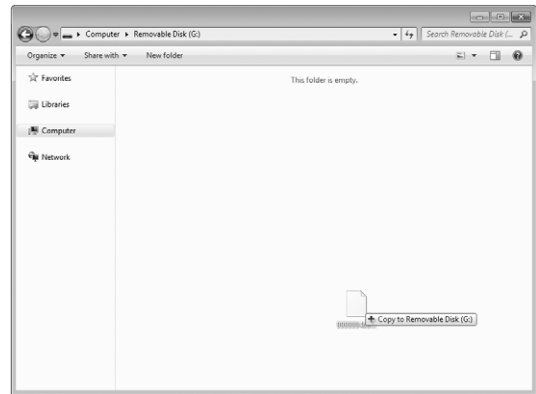

→ Pattern data in “Removable Disk” is written to the machine.

Note

- While data is being written, do not disconnect the USB cable.
- Do not create folders within “Removable Disk”. Since folders are not displayed, stitch pattern data within folders cannot be recalled.

4 Press .

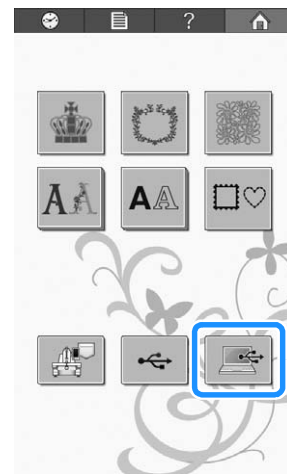

→ The patterns in the computer are displayed on the selection screen.

5 Touch the key of the pattern you want to recall.

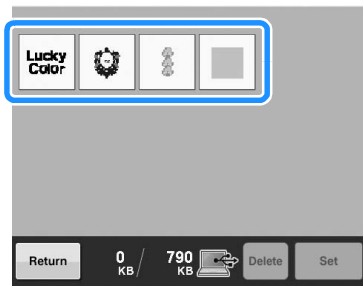

6 Touch **Set**.

* Touch **Delete** to delete the pattern from the computer.

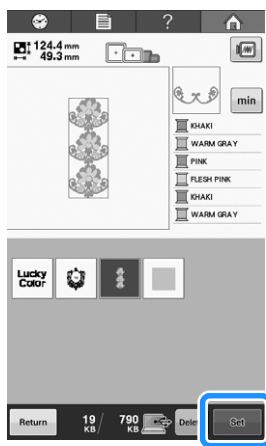

→ The Embroidery Edit screen is displayed.

Editing the Embroidery Pattern (Pattern Editing Screen)

The patterns can be edited from the pattern editing screen and the embroidering screen. Individual patterns can be edited with the pattern editing screen, and the entire pattern can be edited within the embroidering screen. The results of editing the pattern can be seen in the pattern display area.

Combining patterns

Various patterns, such as embroidery patterns, frame patterns, built-in alphabet patterns and patterns on embroidery cards, can easily be combined.

1 Touch **Add**.

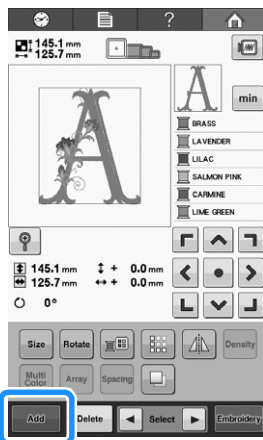

→ The pattern type selection screen appears again.



① Touch this key to quit trying to combine patterns. The pattern editing screen appears.

2 Select an embroidery pattern.

Select the pattern to be added as described on page 106 to 117.

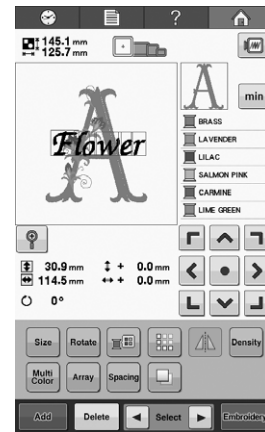

- When another pattern is selected, it is normally added at the center of the pattern display area.

3 Repeat steps 1 and 2 until all patterns to be combined are selected.

Memo

- The position of individual patterns and other editing operations can be performed from the pattern editing screen. The editing operations can be performed in the same way from the pattern editing screen whether it is displayed as each pattern is selected or after all patterns that you wish to combine have been selected.

Selecting the pattern to be edited

If multiple patterns are selected, you can choose which pattern will be edited.

1 Touch ◀ or ▶.

The pattern that will be edited is the pattern enclosed by the red frame.

Continue touching ◀ and ▶ until the red frame is around the pattern that you wish to edit.

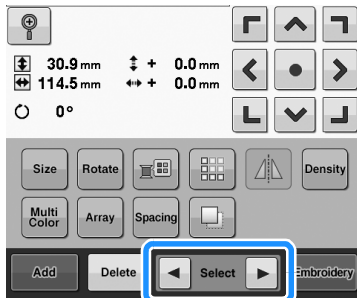

→ The patterns are selected in the order or the opposite order that they were added to the pattern.

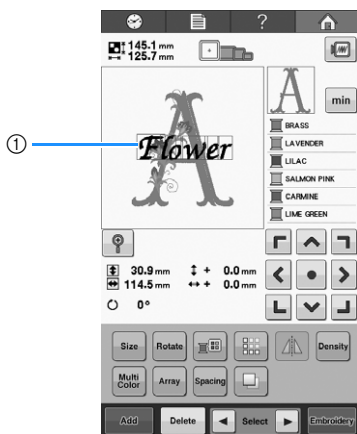

① Red frame indicating the pattern to be edited.

Memo

- If multiple patterns appear in the pattern editing screen, the basic editing procedure is to 1. select the pattern to be edited, and then 2. edit that pattern.

Displaying the enlarged pattern image

When selecting the small pattern, display the enlarged pattern image to check in detail.

1 Touch .

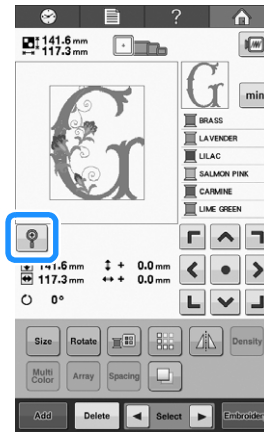

→ The pattern image is displayed with 200% enlarged.

2 Move the pattern image to check when all the pattern image is not displayed.

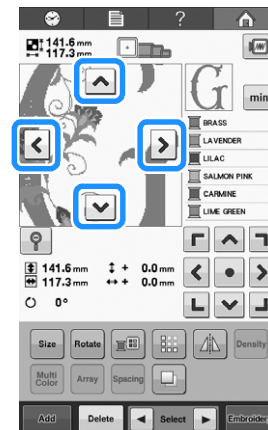

- Touch  to return to the normal pattern image.

Moving a pattern

Determine where in the embroidery frame the pattern will be embroidered. If multiple patterns are combined, move each pattern to lay out the pattern.

- 1 Touch the key for the direction where you wish to move the pattern.

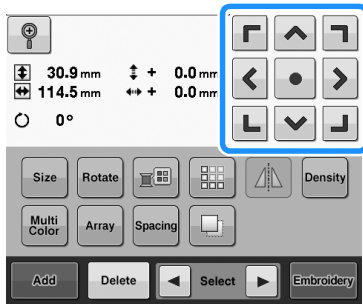

→ The pattern moves in the direction of the arrow on the key.

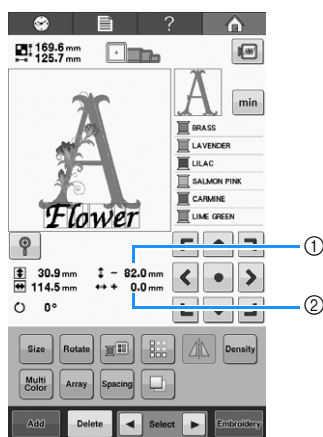

- ① Shows the vertical distance moved from center.
 - ② Shows the horizontal distance moved from center.
- To return the pattern to its position before it was moved (center of the embroidery frame), touch .

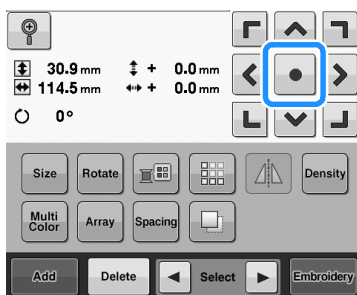

The pattern can also be moved by dragging it. The pattern can also be dragged by selecting it directly in the screen with your finger or the touch pen.



Note



- The pattern can only be moved when the arrow keys are on the screen.



Memo

- The arrow keys in the embroidering screen are used to move the frame to select the embroidering position.

Flipping a pattern horizontally

- 1 Touch  so that it changes to .

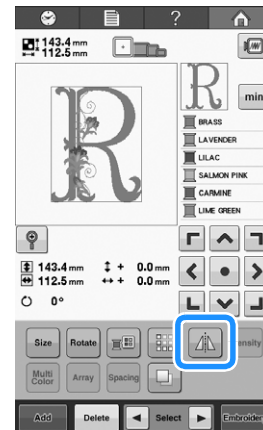

→ The pattern is flipped horizontally.

- Each touch of the key turns the setting either on or off.



Horizontal flip turned off



Flipped horizontally

Changing the size of a pattern

1 Touch **Size**.

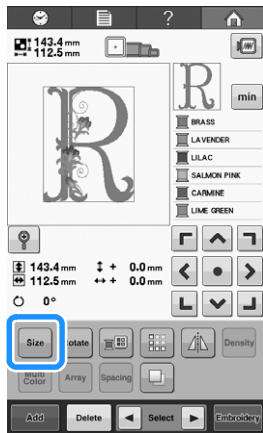

→ The screen shown below appears.

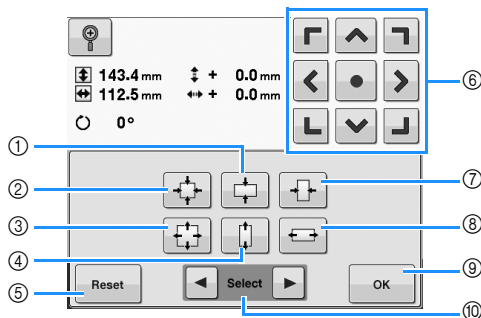

Example: Original size

- ① Reduces only in the vertical direction.
- ② Enlarges without changing the height-to-width proportion.
- ③ Reduces without changing the height-to-width proportion.
- ④ Enlarges only in the vertical direction.
- ⑤ Touch this key to return the pattern to its original size.
- ⑥ Moves the pattern in the direction of the arrow on the key.
- ⑦ Reduces only in the horizontal direction.
- ⑧ Enlarges only in the horizontal direction.
- ⑨ Touch this key to close this screen.
- ⑩ Touch this key to select the pattern to edit.



2 Touch the keys to adjust the pattern to the desired size.

Each touch of a key slightly enlarges or reduces the pattern.

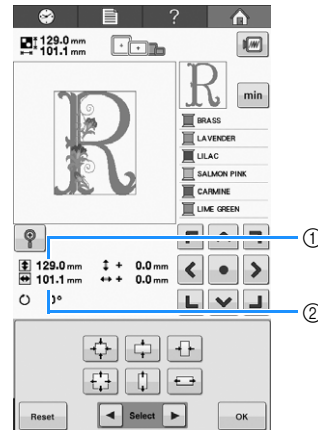

The size of the pattern is displayed after a key is touched to change it.

- ① Vertical length
 - ② Horizontal width
- The size that the pattern can be enlarged depending on the pattern or character.
 - If the pattern is rotated, the vertical and horizontal directions may be reversed.
 - To return the pattern to its original size, touch **Reset**.

3 If necessary, touch the arrow keys to adjust the position of the pattern.

For more details, refer to "Moving a pattern" on page 121.

4 After making the desired changes, touch **OK**.

→ The pattern editing screen appears again.

CAUTION

- After changing the size of the pattern, check the icons for the embroidery frames that can be used and use only the indicated frames. If a frame other than those indicated are used, the presser foot may hit the embroidery frame and cause injuries.

Rotating a pattern

The pattern can be rotated between 1 and 359 degrees either clockwise or counterclockwise.

1 Touch **Rotate**.

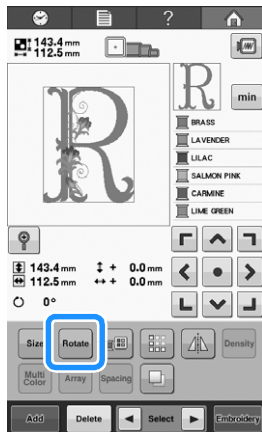

→ The screen shown below appears.

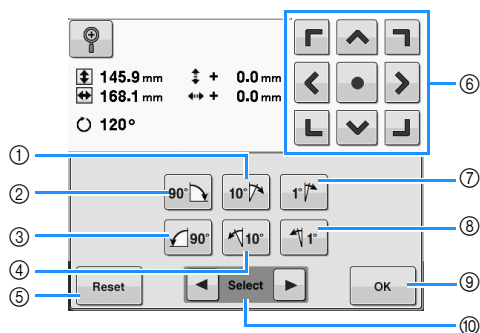

Example: Original angle

- ① Rotates 10 degrees to the right
- ② Rotates 90 degrees to the right
- ③ Rotates 90 degrees to the left
- ④ Rotates 10 degrees to the left
- ⑤ Touch this key to return the pattern to its original angle.
- ⑥ Moves the pattern in the direction of the arrow on the key.
- ⑦ Rotates 1 degree to the right
- ⑧ Rotates 1 degree to the left
- ⑨ Touch this key to close this screen.
- ⑩ Touch this key to select the pattern to edit.



2 Touch the keys to adjust the pattern to the desired angle.

Each touch of a key rotates the pattern.

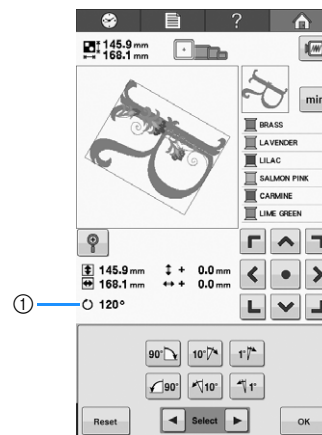

- ① Shows the angle of the pattern after a key is touched to change it.

- To return the pattern to its original angle, touch



3 If necessary, touch the arrow keys to adjust the position of the pattern.

For more details, refer to “Moving a pattern” on page 121.

4 After making the desired changes, touch **OK**.



→ The pattern editing screen appears again.

CAUTION

- After changing the angle of the pattern, check the icons for the embroidery frames that can be used and use only the indicated frames. If a frame other than those indicated are used, the presser foot may hit the embroidery frame and cause injuries.

Memo

- If **Rotate** in the embroidering screen is used, the entire combined pattern can be rotated. (For details, refer to “Rotating the entire pattern” on page 137.)
- If the pattern is too large or the pattern is too close to the edge of the embroidery field, rotating options may not apply.

Changing the text arrangement of a character

Characters can be arranged on a horizontal line, on a slant or on an arc.

1 Touch .

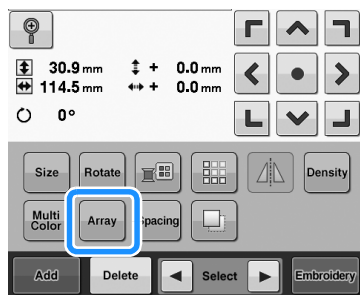

→ The screen shown below appears.

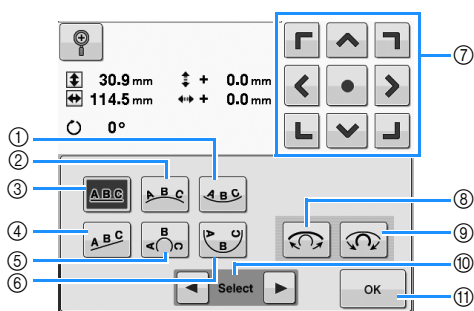





- ① Arranges the text on the inside of a wide curve.
- ② Arranges the text on the outside of a wide curve.
- ③ Arranges the text on a straight line.
- ④ Arranges the text on a slanted line.
- ⑤ Arranges the text on the outside of a sharp curve.
- ⑥ Arranges the text on the inside of a sharp curve.
- ⑦ Moves the pattern in the direction of the arrow on the key.
- ⑧ If touched after selecting a text arrangement on a curve, each touch of this key decreases the bend of the curve (makes it flatter).
- ⑨ If touched after selecting a text arrangement on a curve, each touch of this key increases the bend of the curve (makes it more curved).
- ⑩ Touch this key to select the pattern to edit.
- ⑪ Touch this key to close this screen.

2 Touch the key of the desired text arrangement.

3 After selecting the desired text arrangement, the bend of the curve can be adjusted. If necessary, touch and to adjust the bend of the curve.

Memo

- When selecting ,  and  change to  and . You can increase or decrease the incline.

4 If necessary, touch the arrow keys to adjust the position of the pattern.

For more details, refer to “Moving a pattern” on page 121.

5 After making the desired changes, touch .

→ The pattern editing screen appears again.



Memo

- The text arrangement specified when the character was selected on page 111 can be changed at this point.

Changing the character spacing

The spacing between the characters can be made wider or narrower.

1 Touch .

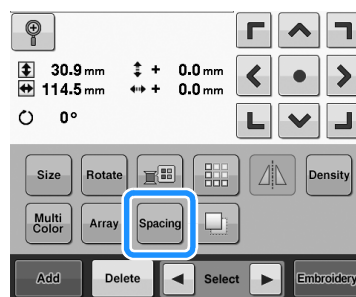

→ The screen shown below appears.

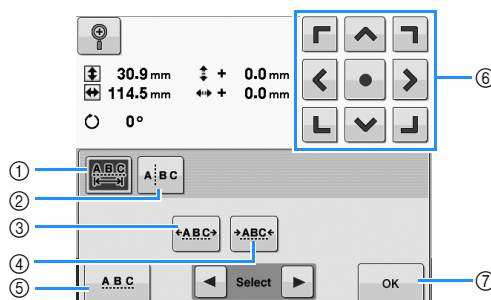

- ① Specifies that all of the characters in a word selected will be spaced equally.
- ② Separates characters to be spaced and positioned individually.
- ③ Increases the space between characters equally.
- ④ Decreases the space between characters equally.
- ⑤ Selects the standard character spacing (original character spacing).
- ⑥ Moves the pattern in the direction of the arrow on the key.
- ⑦ Touch this key to close this screen.

2 Touch the keys to adjust the characters to the desired spacing.

Each touch of a key slightly increases or decreases the character spacing.

- To return the characters to their original spacing, touch .

3 If necessary, touch the arrow keys to adjust the position of the pattern.

For more details, refer to "Moving a pattern" on page 121.

4 After making the desired changes, touch .

Separating combined character patterns

Combined character patterns can be separated to adjust the character spacing or to separately edit the patterns after all character have been entered.

1 Touch .

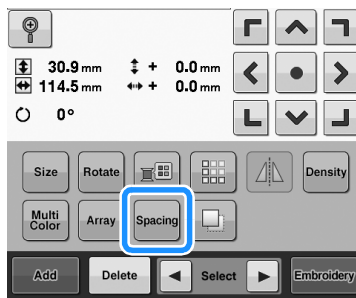

2 Touch .

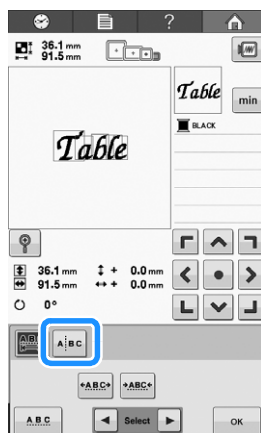

→ The key appears as .

3 Use to select where the pattern is to be separated, and then touch to separate it. For this example, the pattern will be separated between "T" and "a".

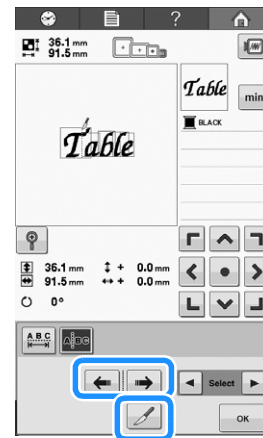

Note

- A separated character pattern cannot be combined again.

4 Use and to select a pattern, and then use to adjust the character spacing.

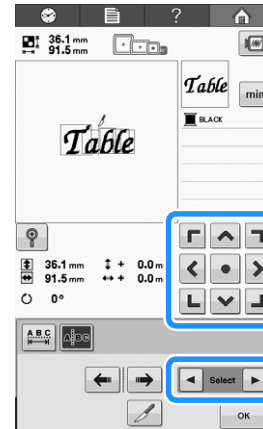

5 Touch .

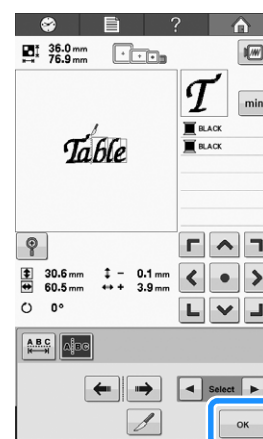

Changing the thread density (only for some character and frame patterns)

The thread density for some character and frame patterns can be changed.

A setting between 80% and 120% in 5% increments can be specified.

1 Touch .

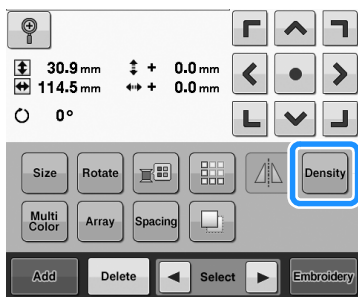

→ The screen shown below appears.

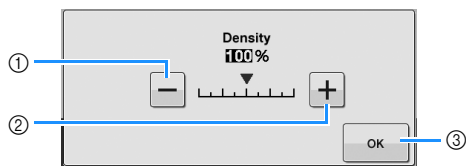

- ① Reduces thread density
- ② Increases thread density
- ③ Touch this key to close this screen.

■ Reduces thread density



■ Increases thread density



2 Touch the keys to select the desired thread density.

Each touch of a key slightly increases or decreases the thread density.

- To return to the original thread density (standard), select "100%".



3 After making the desired changes, touch



→ The pattern editing screen appears again.

Specifying multi-color text

The alphabet pattern characters selected on page 108 are set to black. The color of the characters can be changed using the change thread color key; however, to change the color of individual characters, touch the Multi Color key to turn it on, and then specify the color for each character.

1 Touch  so that it changes to .

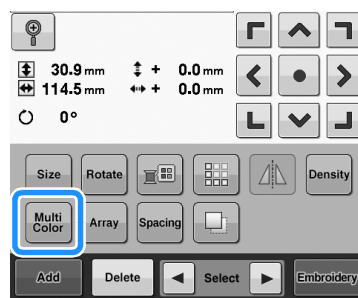

- Each touch of the key turns the setting either on or off.



Multi-color text turned off

Multi-color text turned on

- For details on changing the thread color, refer to "Changing the colors of the pattern" on page 127.

Changing the colors of the pattern

The colors of the pattern can be changed and previewed on the screen.

By changing the colors of the pattern, the same pattern can be viewed in various ways.

If your thread colors are registered in a color thread table and if you used the table for changing color, the thread spools can be assigned with the thread colors that you have. And the pattern displayed in the screen will appear with colors that are almost the same as the actual thread colors.

With this operation, the colors of all patterns will be changed, not just those of the pattern being edited.

1 Touch .

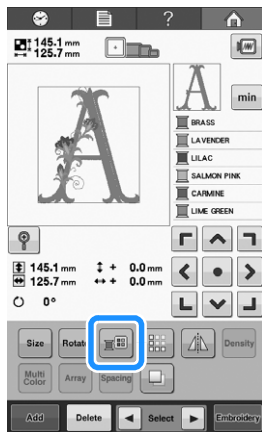

→ The 64 embroidery threads table screen appears.

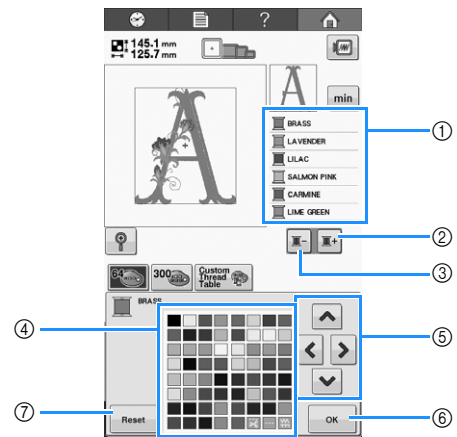

- ① The part of the pattern in the color at the top of the thread color sequence display is the part whose color is being changed.
- ② Selects the next color in the thread color sequence display.
- ③ Selects the previous color in the thread color sequence display.
- ④ Color thread table
Select a color from this table.
- ⑤ Use these keys to select a color from the color thread table.
- ⑥ Touch this key to close this screen.
- ⑦ Touch this key to return to the original color.

2 Touch and until the color to be changed appears at the top of the thread color sequence display.

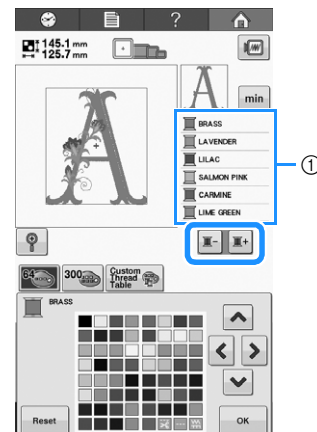

- ① The thread color for the part of the pattern displayed at the top will be changed.

- 3 Touch , ,  and  to select the new color from the color palette.

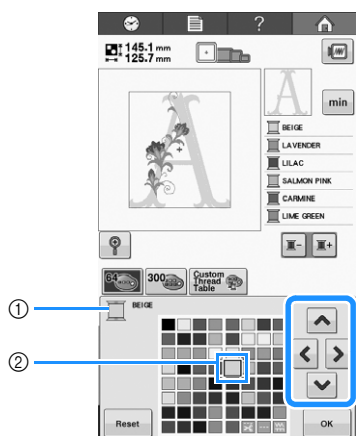

- ① Displays the name of the selected thread color
 - ② The color that appears enlarged is the color that is selected.
- In the pattern display area, the color of the selected part of the pattern is changed.

- 4 Touch .

- The color change is confirmed.
→ The pattern editing screen appears again.



Memo

- The color thread table can be changed to a custom thread table that you create to reflect the thread colors that you have. (Refer to “Creating a custom thread table” on page 132.)

Designing repeated patterns

■ Embroidering repeated patterns

Using the border function, you can create repeated patterns. You can also adjust the spacing of the patterns within a repeated pattern stitch.

- 1 Touch .

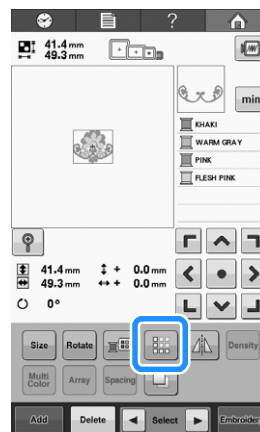

2 Select the direction in which the pattern will be repeated.

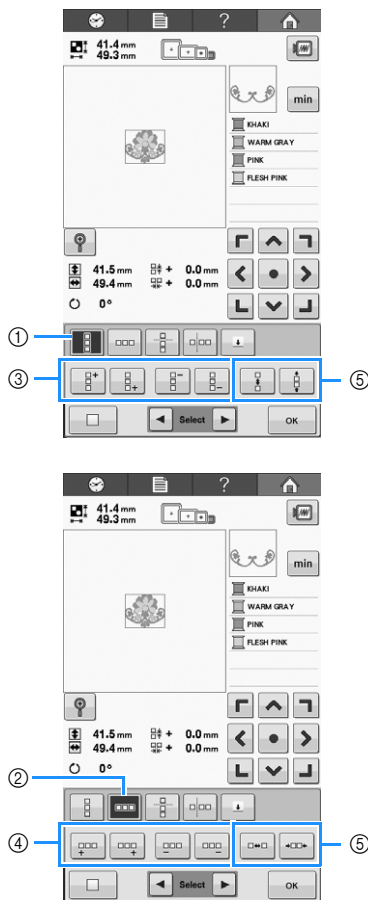

- ① Vertical direction
 - ② Horizontal direction
 - ③ Repeating and deleting vertical keys
 - ④ Repeating and deleting horizontal keys
 - ⑤ Spacing keys
- The pattern direction indicator will change depending on the direction selected.

3 Use to repeat the pattern on top and to repeat the pattern at the bottom.

- To delete the top pattern, touch .
- To delete the bottom pattern, touch .

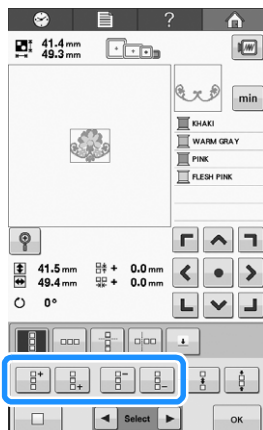

4 Adjust the spacing of the repeated pattern.

- To widen spacing, touch .
- To tighten spacing, touch .

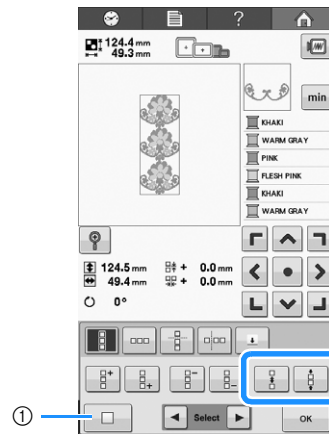

- ① Touch to change a repeated pattern back to one single pattern.

Memo

- You can only adjust the spacing of patterns included in the red frame.

5 Complete repeated patterns by repeating steps 2 through 4.

6 After making the desired changes, touch .

The pattern editing screen appears again.

Memo

- When there are two or more patterns, all patterns will be grouped together as one pattern in the red frame.

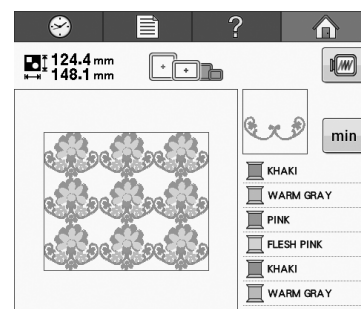



- When changing the direction in which the pattern will be repeated, all of the patterns in the red frame will automatically be grouped as one repeating unit. See the following section on how to repeat one element of a repeated pattern.



■ Repeating one element of a repeated pattern

By using the Cut function, you can select one element of a repeated pattern and repeat only that single element. This function allows you to design complex repeated patterns.

1 Choose the direction in which the repeated pattern will be cut.

- Touch  to cut horizontally.
- Touch  to cut vertically.

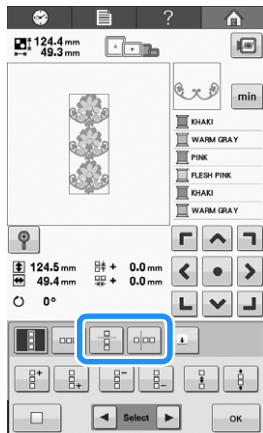

→ The pattern direction indicator will change depending on the direction selected.

2 Use and to select the cut line.

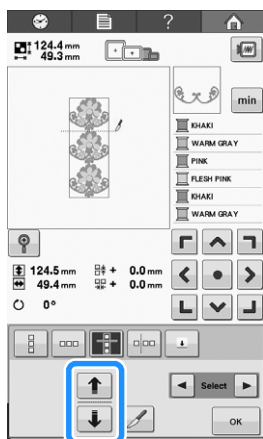

→ The cut line will move.

3 Touch .

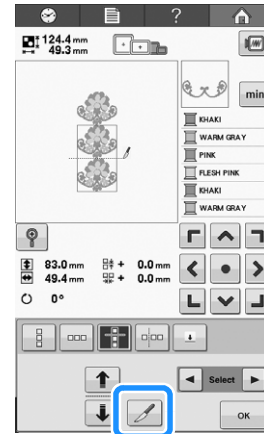

→ The repeated pattern will be divided into separate elements.

4 Touch .

5 Use and to select the element to repeat.

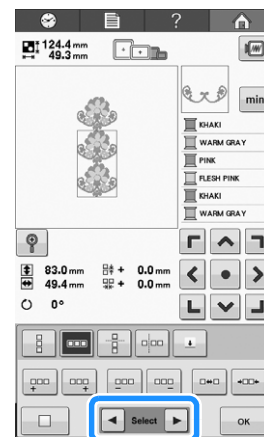

6 Repeat the selected element.

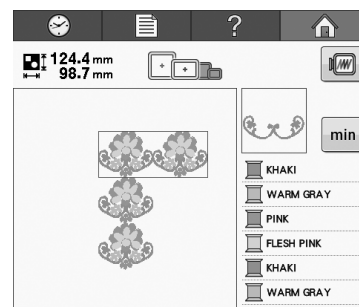

7 After making the desired changes, touch

OK.

The pattern editing screen appears again.

Note

- Once you have cut a repeated pattern into separate elements, you cannot return to the original repeated pattern.
- Each element can be edited separately in the edit screen. Refer to “Selecting the pattern to be edited” on page 120.

Assigning thread marks

By sewing thread marks, you can easily align patterns when embroidering a series. When embroidering is finished on a pattern, a thread mark in the shape of an arrow will be sewn using the final thread. When embroidering a series of patterns, use the point of this arrow for positioning the following patterns to be embroidered.

Memo

- When repeatedly embroidering individual patterns, thread marks can be sewn around the perimeter of the pattern only.

1 Touch .

2 Touch .

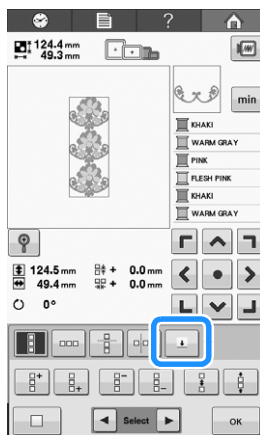



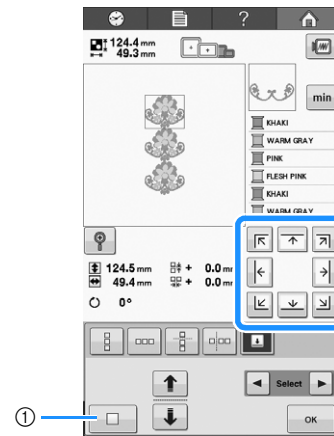

3 Touch  to select the thread mark to be sewn.



① Touch to cancel thread mark setting.

Memo

- When there are two or more elements, use  and  or  and  to select a pattern that you want to assign a thread mark(s) to.

4 Touch .

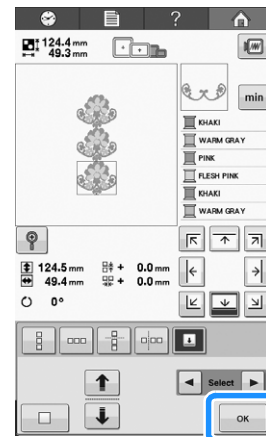

Creating a custom thread table

You can create a custom thread table containing the thread colors that you most often use. You can select thread colors from the machine's extensive list of thread colors from nine different thread brands. You can select any color and move the color to your custom thread table.





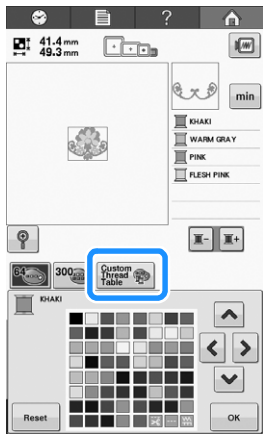

Note

- Some machines may already have an additional 300 Robison-Anton thread colors contained in the custom thread table. 300 Robison-Anton thread colors table data can be downloaded from our website "<http://support.brother.com>".

- 1 Touch  and then touch .





- 2 Use     to choose where to add a color on the custom thread table.

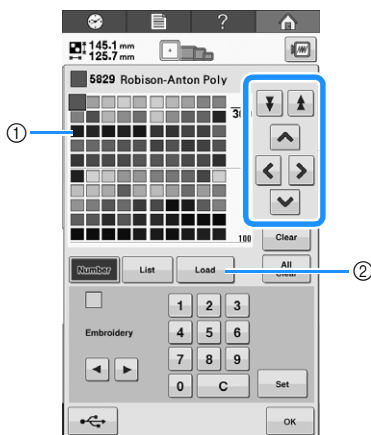







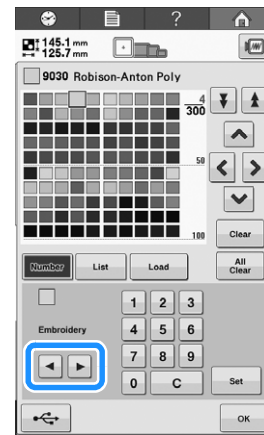

- You can choose colors from the custom thread from the custom thread table by directly touching the screen with the touch pen.
- You can scroll through 100 colors at a time using  and  on the custom thread table.



- 1 Custom thread table
- 2 Touch  to download the clear and restore programs from the website

- 3 Use   to select one of the thread brands in the machine.



- 4 Use           to enter a color's 4-digit number.

- If you make a mistake, touch  to erase the entered number, and then enter the correct number.

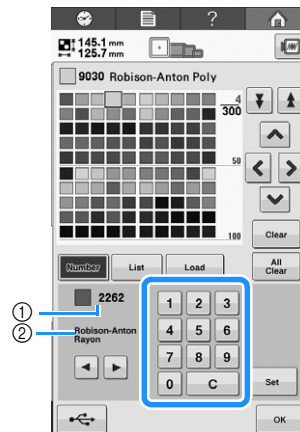

- 1 Entered thread color number
- 2 Thread brand

- 5 Touch .

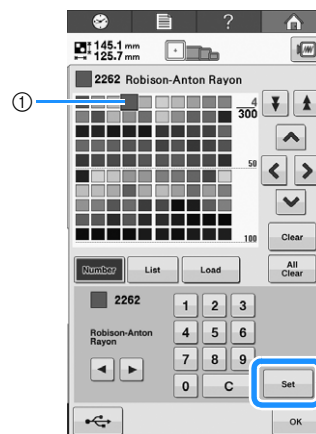

- 1 Selected thread color
→ The selected thread color is set in the custom thread table.

**Note**

- If **Set** is not touched, the thread color number will not be changed.

6 Repeat the previous steps until all desired thread colors are specified.

- To delete a specified color from the palette, touch **Clear**.
- To delete all the specified color from the palette, press **All Clear**.

7 Touch **OK** to return to the original screen.

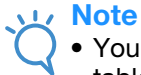
**Note**

- You can save the created custom thread table data. Refer to “Saving the Custom Thread Table to USB media” on page 133 for the detailed procedure.

■ Adding a color to the custom thread table from the list

1 Repeat the previous step 1 on page 132.

2 Touch **List** to display the thread list.

3 Use **▲** **▼** to select a thread color.

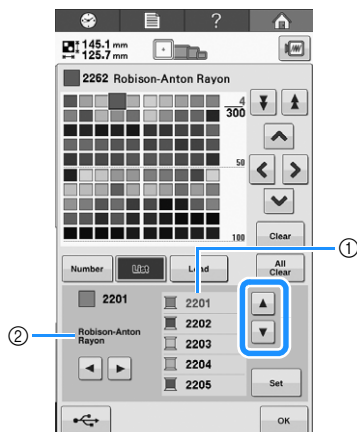

- ① Thread list
- ② Thread brand

4 Touch **Set**.

5 Repeat the previous steps until all desired thread colors are specified.

- To delete a specified color from the palette, touch **Clear**.
- To delete all the specified color from the palette, press **All Clear**.

6 Touch **OK** to return to the original screen.

■ Saving the Custom Thread Table to USB media

Since you can only have one Custom Thread chart in the machine at a time, you are reminded to save the chart that you have just created to USB media.

**Note**

- Custom thread table data can only be saved to USB media. You cannot save the data in the machine's memory or in the computer.
- Custom thread table data is saved as “.pcp” data file.

1 Press **Custom Thread Table** and then press **Custom Thread Table**.



2 Set your desired colors in the custom thread table according to the procedure in “Creating a custom thread table” on page 132.

3 Insert the USB media into the USB port on the machine.

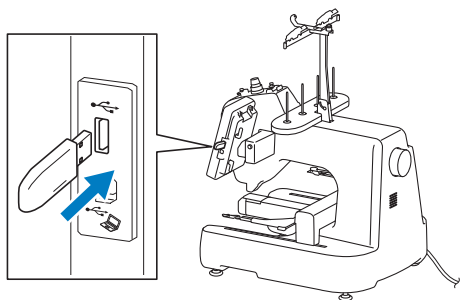

- ① USB port
- ② USB media

4 Press .

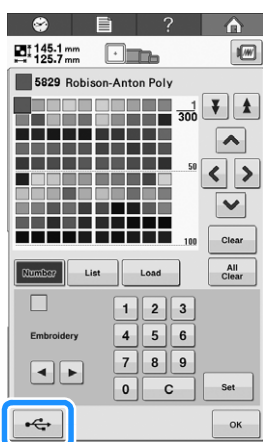

→ The “Saving...” screen is displayed. When the data is saved, the display returns to the original screen automatically.



Note

- Do not insert or remove USB media while “Saving...” screen is displayed. You will lose some or all of the data you are saving.

■ Recalling the Custom Thread Table data from USB media

You can recall a custom thread table data from USB media.





Note

- Do not store two or more “.pcp” data files in USB media. You can only recall one custom thread table data at a time.

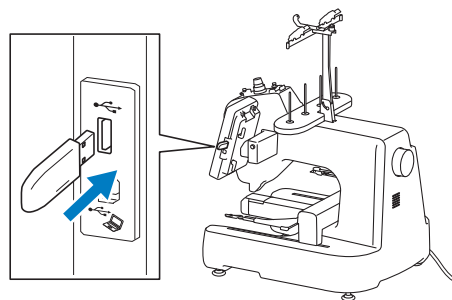
1 Insert the USB media containing the custom thread table data into the USB port.



- ① USB port
- ② USB media

2 Press  and then press .

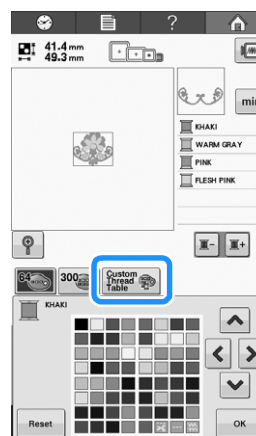

3 Press .

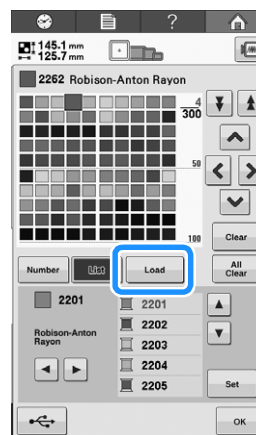

→ The “Saving...” screen is displayed. When the data is loaded to the machine, the display returns to the original screen automatically.



Note

- Do not insert or remove USB media while “Saving...” screen is displayed. You will lose some or all of the data you are saving.

4 The recalled custom thread table is displayed on the screen.



Choosing a color from the custom thread table

You can select a color from the up to 300 thread colors you have set in the custom thread table.

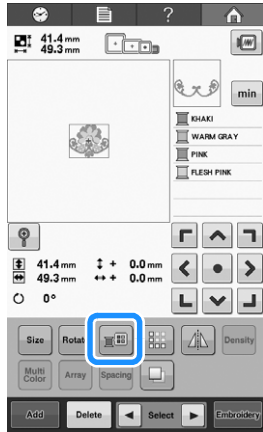
1 Touch .



→ The 64 embroidery threads table screen displays.

2 Touch  or  to select the thread color you want to change.

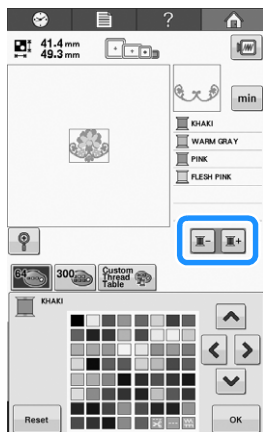

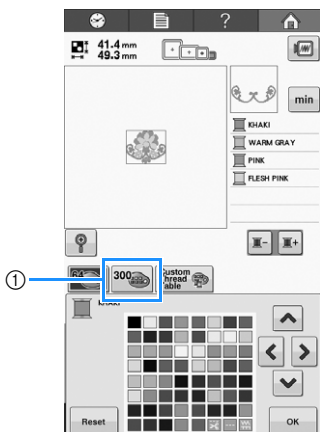

3 Touch .



① Custom thread change key

→ The custom thread (300 embroidery threads) table screen will appear.

4 Touch , , ,  to choose a new color from the custom thread table.

- Use  and  to scroll through the custom thread table.
- Touch  to return to the original color.
- You can choose colors from the custom thread (300 embroidery threads) table by directly touching the screen with the touch pen.

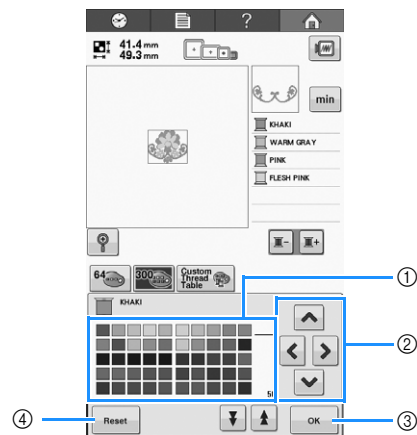

- ① Color thread table
Select a color from this table.
- ② Use these arrows to navigate the color selection within the color thread table.
- ③ Touch this key to close this screen.
- ④ Touch this key to return to the original color.
→ The display shows the changed colors.

5 Touch .

Duplicating a pattern

1 Touch .

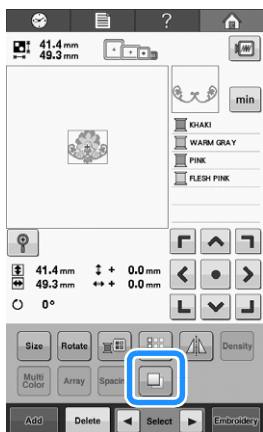

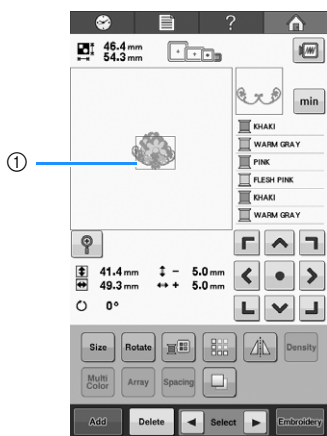

→ The duplicate is positioned over the original pattern.



① Duplicated pattern



Note

- If multiple patterns are displayed in the screen, only the pattern selected using  and  is duplicated.
- Move and edit each duplicated pattern individually.

Deleting a pattern

1 Touch .

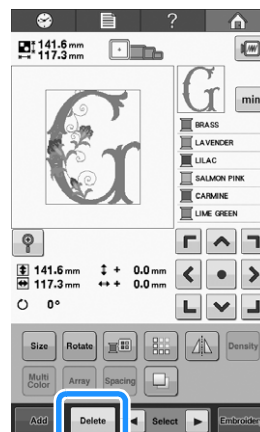

→ The screen shown below appears.

2 Touch .

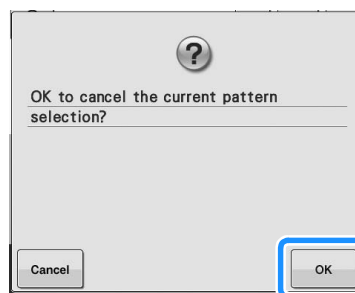

→ The pattern is deleted.

- To quit deleting the pattern, touch .



Note

- If multiple patterns are displayed, only the pattern selected will be deleted.

Editing the Embroidery Pattern (Embroidering Screen)

In the embroidering screen, a single pattern can be edited if patterns were not combined or an entire combined pattern can be edited as a single pattern.

In addition, the arrow keys can be used to move the pattern in the pattern editing screen or move the embroidery frame in the embroidering screen. Touching these keys moves the embroidery frame.

Rotating the entire pattern

The entire pattern can be rotated.

- 1 Touch **Rotate**.

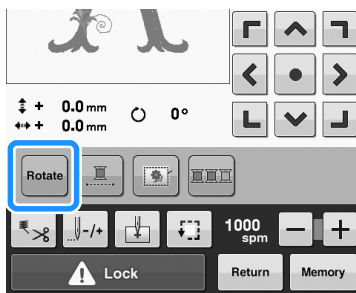

→ The screen shown below appears.

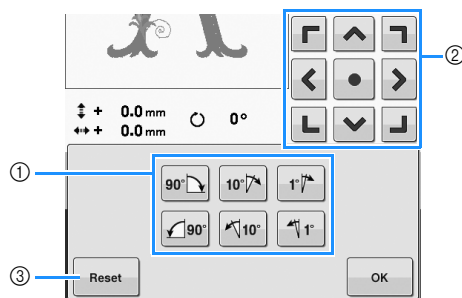

- ① Enables the entire pattern to be rotated.
- ② Enables the embroidery frame to be moved.
- ③ Touch this key to close this screen without making changes.

- 2 Touch the keys to adjust the pattern to the desired angle.

For more details, refer to “Rotating a pattern” on page 123.

- 3 If necessary, touch the arrow keys to adjust the position of the embroidery frame.

For more details, refer to “Changing the Embroidering Position” on page 83.

- 4 After making the desired changes, touch **OK**.

→ The embroidering screen appears again.

Editing a Combined Pattern

In this section, we will combine text with floral alphabet pattern, which we will then edit.



1 Touch .



2 Touch .

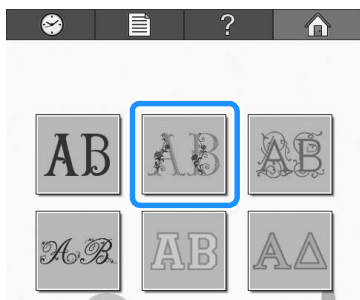

3 Select .

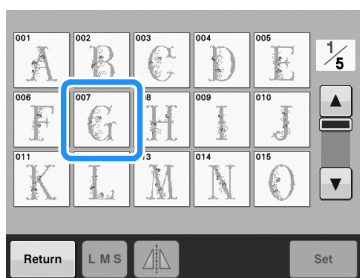

→ This pattern will be positioned at the center of the embroidery area.

4 To select the pattern, touch .

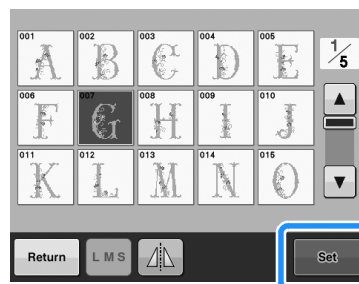

→ The pattern editing screen appears.

5 Touch .

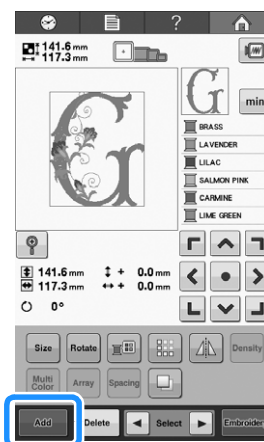

→ The pattern type selection screen appears again.

6 Touch **AA**.



7 Touch **ABC**.

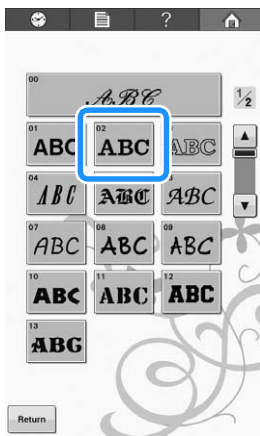

8 Type "ood", and then touch to enter a line feed.

Touch the tab for lowercase letters to display the lowercase letters input screen, and then touch "o", "o", then "d".



- The selected letters appear at the center of the embroidery area.
- To change the size of the pattern, select "o", and then touch **LMS** to select the desired size.
 - To change the text arrangement, touch **Array**, and then select the desired text arrangement.

9 Type "Luck".

After touching "L", touch the tab for lowercase letters to display the lowercase letters input screen, and then touch "u", "c", then "k".



→ The selected letters appear under the previously typed letters.

- To change the text alignment, touch .

10 After selecting the characters, touch **Set**.



→ The pattern editing screen appears.

11 Touch / / and adjust the position of the letters so that they are well balanced.



12 Check the balance of the entire pattern, and, if you wish to edit the pattern, touch and to select the pattern to be edited.

Patterns can be selected by directly touching the screen with your finger or touch pen.

- 13 Touch , and then touch  to preview the pattern.



- Touch  to return to the previous screen.

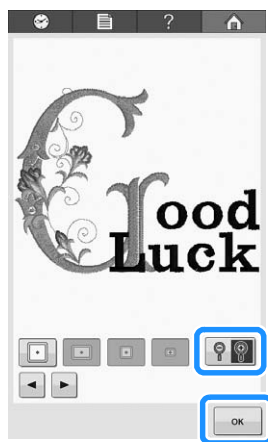

- 14 After finishing all editing, touch . → The embroidering screen appears.

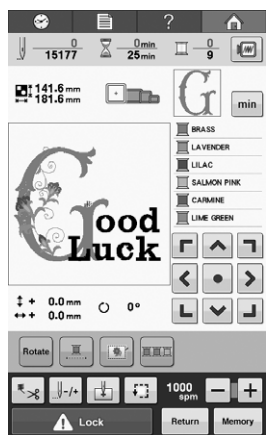

- To return to the pattern editing screen and continue editing the pattern, touch .

Chapter 6

BASIC SETTINGS AND HELP FEATURE



This chapter contains descriptions on the use of the settings keys and the machines operation guide keys, introduced on page 30. Details on changing the basic embroidery machine settings and viewing operations on the LCD will be provided.

Using the Settings Key	142
Understanding the settings screen	142
■ Page 1	142
■ Page 2	142
■ Page 3	143
■ Page 4	143
Saving a settings screen image to USB media	144
Changing the display guides	144
Changing the thread color information	145
■ Sample displays	145
Changing the units of measurements	146
Changing the embroidery basting distance	146
Changing the background colors of the embroidery patterns or thumbnails	146
Specifying the thumbnail size	147
Specifying thread sensor	147
Changing the speaker volume	147
Selecting the “Eco Mode” or “Shutoff Support Mode”	148
Setting the opening screen	148
Changing the language	148
Turning “ON” or “OFF” the light	149
Changing the screen brightness	149
Setting the LED pointer	149
Using the Machine Operations Guide Key	150
■ Contents of Categories	150

Using the Settings Key

Touch  (settings key) to change many of the basic embroidery machine settings.

Understanding the settings screen

There are four pages in the settings screen. Touch  and  in the lower-center of the screen until the desired page is displayed. The  key appears on all pages.

■ Page 1

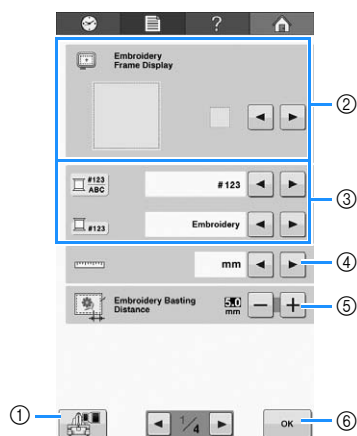

- ① Touch to save the current settings screen image to USB media (Refer to page 144).
- ② The guides (embroidery frame size, centerpoint marker, grid and cursor) for the pattern display area can be specified. (Refer to page 144.)
- ③ The color information can be switched to the color name or the thread brand and color number (Refer to page 145).
- ④ Units of Measure
Enables the units of measurements that appear in the screens to be changed. (Refer to page 145.)
- ⑤ Basting Distance
Specify the distance between the pattern and the basting stitching. (Refer to page 96.)
- ⑥ Touch to quit specifying settings. The settings are confirmed and the screen that was displayed before the settings key was touched appears again.

■ Page 2

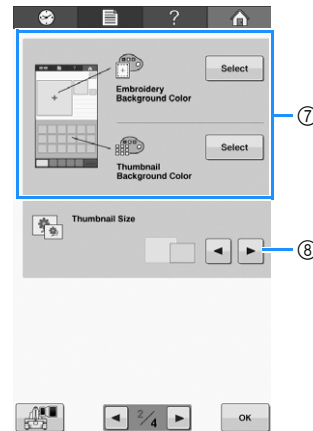

- ⑦ Embroidery Background Color/Thumbnail Background Color
Depending on the color of the embroidery, changing the background color of the pattern display area and thumbnails may make them more visible and easier to select. (Refer to page 146.)
- ⑧ Thumbnail Size
Specifies whether the size of image keys that appear when selecting a pattern from the pattern list screen are displayed “Small” or “Large”. (Refer to page 147.)

Page 3

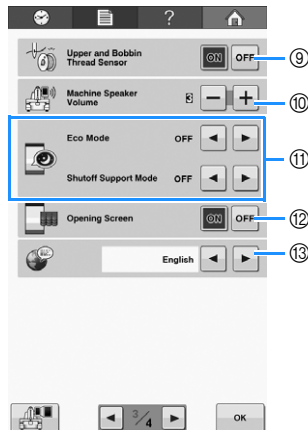

- ⑨ Upper and Bobbin Thread Sensor
Set “Upper and Bobbin Thread Sensor” to either “ON” or “OFF”. (Refer to page 146.)
- ⑩ Machine Speaker Volume
The volume of operation sounds and alarm sounds can be adjusted. (Refer to page 15 or 147.)
- ⑪ Select to save the machine power by setting the “Eco Mode” or the “Shutoff Support Mode” (Refer to page 148).
- ⑫ Opening Screen
The machine can be set so that the opening screen is either displayed (“ON”) or not displayed (“OFF”) when the machine is turned on.
- ⑬ Languages
Enables the display language to be changed. The keys and messages appear in the selected language. (Refer to page 148.)

Page 4

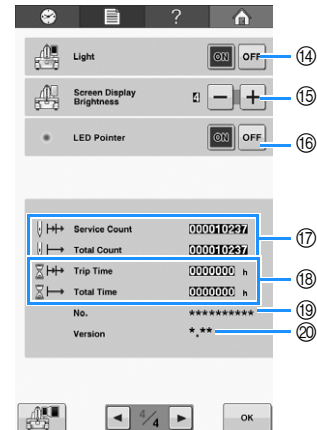

- ⑭ Light
The light can be set to be turned either on or off. (Refer to page 14 or 149.)
 - ⑮ Change the screen display brightness (Refer to page 149).
 - ⑯ Turn on or off the LED pointer light (Refer to page 40).
 - ⑰ The Total Count counter shows the total number of stitches sewn, and the Service Count counter show the number of stitches that have been sewn since the machine’s last maintenance.
 - ⑱ The Total Time counter shows the total amount of time that the machine has been used, and the Trip Time counter shows the amount of time that the machine has been used since its last maintenance.
- Use counters ⑰ and ⑱ as a standard for performing periodic maintenance and for receiving maintenance for the machine.
- ⑲ The “No. ##” is the number for the embroidery machine.
 - ⑳ Version
Shows the version of the software installed on this embroidery machine. (Refer to page 184.)



Note

- Check with your local authorized Brother dealer or at “ <http://support.brother.com> ” for details on available updates.

Details of each of the settings are described in the following sections. After specifying the desired settings, touch to return to the screen that was displayed before the settings screen was displayed.



Note

- Some settings cannot be changed while embroidering.

Saving a settings screen image to USB media

An image of the settings screen can be saved as a BMP file.

A maximum of 100 images can be saved on a single USB media at one time.

This function is available in all pages of settings screen.

- 1 Insert the USB media into the USB port on the right side of the machine.

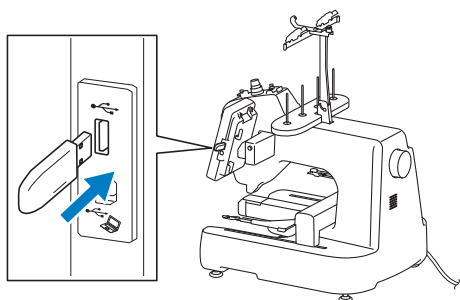

- 1 USB port
- 2 USB media

- 2 Press .

→ The image file will be saved to the USB media.

- 3 Remove the USB media, and then for future reference, check the saved image using a computer.

The files for Settings screen images are saved with the name "S##.BMP".

- * "##" in the name "S##.BMP" will automatically be replaced with a number between S00 and S99.



Note

- If 100 image files have already been saved on the USB media, the following message appears. In this case, delete a file from the USB media or use different USB media.

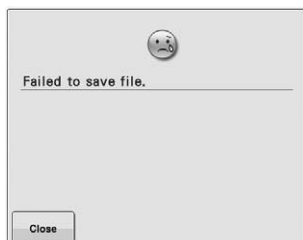

Changing the display guides

The guides in the pattern display area can be set for the attached embroidery frame.

The guide settings can be specified from page 1 of the settings screen.

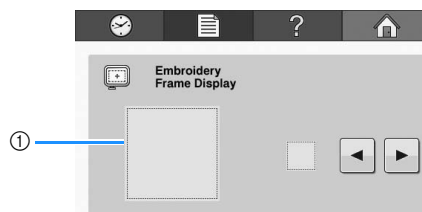

- 1 How the guides will appear with the specified settings can be previewed here.

The centerpoint is indicated with a red plus sign (+).

When the embroidery machine is purchased, the centerpoint marker and grid lines are not displayed.

- 1 Touch  and  to select whether or not to display the centerpoint marker and the grid lines.

Grid lines



Cross grid lines



Centerpoint marker



Centerpoint marker and grid lines



Centerpoint mark with cross grid lines



No centerpoint marker or grid lines



Changing the thread color information

You can display the name of the thread colors, embroidery thread number or the embroidery time.

When the embroidery machine is purchased, the thread color number (#123) is selected.

The thread color display setting can be specified from page 1 of the settings screen.

- 1 Touch and to display the name of the thread colors, the embroidery thread number or the embroidering time.

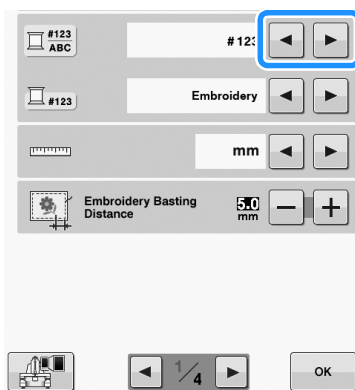

- 2 When the thread number #123 is displayed, touch and to select from six embroidery thread brands pictured next.

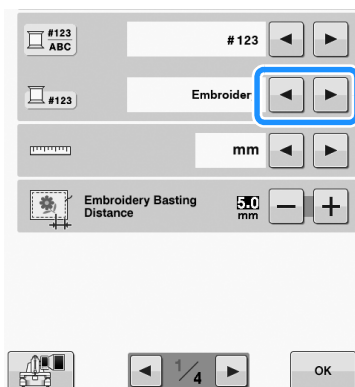

Sample displays

Thread color number (#123)

Embroidery (Polyester)	Country (Cotton*)
107 Embroidery	126 Country
007 Embroidery	588 Country
005 Embroidery	020 Country
007 Embroidery	588 Country
107 Embroidery	126 Country
Madeira Poly (Polyester)	Madeira Rayon (Rayon)
1984 Madeira Poly	1383 Madeira Rayon
1767 Madeira Poly	1166 Madeira Rayon
1812 Madeira Poly	1087 Madeira Rayon
1767 Madeira Poly	1166 Madeira Rayon
1984 Madeira Poly	1383 Madeira Rayon
Sulky (Rayon)	Robison-Anton (Polyester)
1533 Sulky	5804 R-A Poly
1535 Sulky	5737 R-A Poly
1011 Sulky	5640 R-A Poly
1535 Sulky	5737 R-A Poly
1533 Sulky	5804 R-A Poly

* Depending on the country or area, cotton-like polyester thread is sold.

Thread color name

Name of Color

- DARK FUCHSIA
- PRUSSIAN BLUE
- SILVER
- PRUSSIAN BLUE
- DARK FUCHSIA

Memo

- The thread colors in the thread color sequence display and in the patterns in the pattern display area are displayed in the original thread color (i.e. the thread colors that have been built-in the machine). The thread color numbers are displayed with the number (or the nearest number) for the brand specified here.
- Colors on the screen may vary slightly from actual spool colors.



Changing the units of measurements

The units of measurements can be set to millimeters or inches.

When the embroidery machine is purchased, "mm" is selected.

The measurement units setting can be specified from page 1 of the settings screen.

- 1 Touch and to select the desired measurement units.

The desired units are displayed.

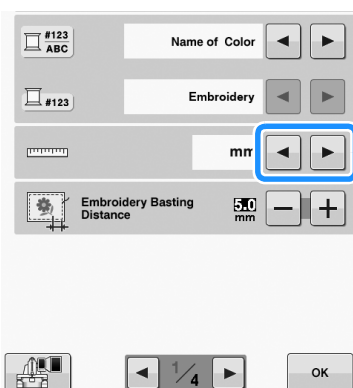

Changing the embroidery basting distance

The distance from the pattern to the basting stitching can be set to 0.0 mm to 12.0 mm (15/32 inch).

When the embroidery machine is purchased, "5.0 mm" (25/128 inch) is selected. Refer to "Basting Embroidery" on page 96 when using this setting.

The distance setting can be specified from page 1 of the settings screen.

- 1 Use and to specify the distance from the pattern to the basting stitching.

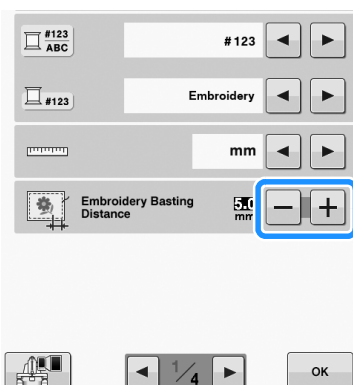

Changing the background colors of the embroidery patterns or thumbnails

The background colors of the pattern display area and pattern thumbnails. Depending on the pattern color, select the desired background color from the 66 settings available. Different background colors can be selected for the pattern display area and pattern thumbnails.

When the embroidery machine is purchased, white color is selected.

The background color settings can be specified from page 2 of the settings screen.

- 1 Touch .

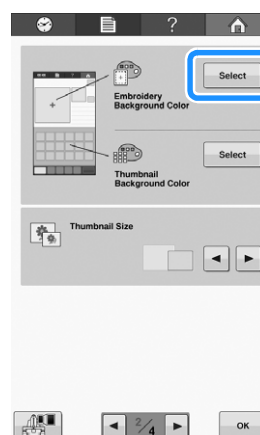

- 2 Select the background color from the 66 settings available.

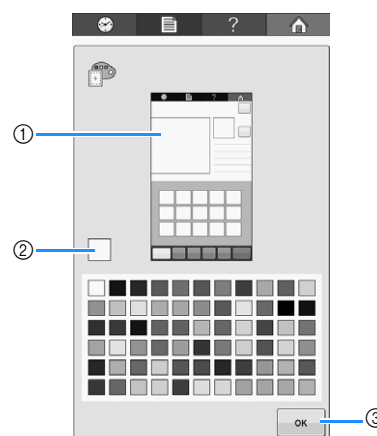

- 1 Embroidery Background colors / Thumbnail Background colors
- 2 Selected color
- 3 Touch to return to the settings screen.



Memo

- The setting remains selected even if the machine is turned off.

Specifying the thumbnail size

You can set whether the thumbnails for selecting an embroidery pattern are displayed in normal size or large size. Large size is 1.5 times the normal size.

When the embroidery machine is purchased, normal size is selected.

The thumbnail size setting can be specified from page 2 of the settings screen.

- 1 Touch ◀ and ▶ to select the desired thumbnail size.

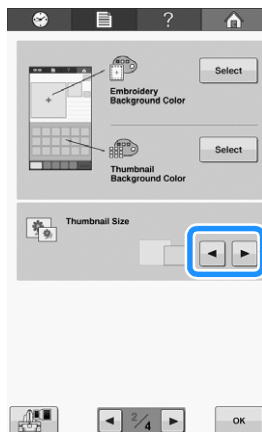

Note

- The thumbnail size will not show a change while in the pattern selection screen. In this case, return to the category selection screen and reselect a pattern category.

Specifying thread sensor

If thread sensor is set to "OFF", the machine does not stop until embroidering is finished, even if the thread breaks or there is no more thread in the bobbin. Set thread sensor to "ON", except when it is necessary to set it to "OFF".

When the machine is purchased, "ON" is selected.

The thread sensor can be specified from page 3 of the settings screen.

- 1 Touch ON or OFF to select the desired setting.

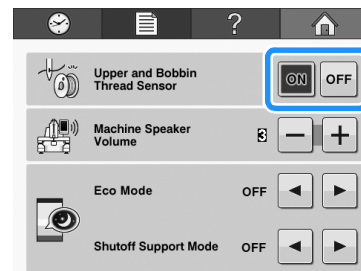

Note

- Normally, set thread sensor to "ON". When thread sensor is set to "OFF", the machine will not be able to detect if the upper thread has become tangled. Continuing to use the machine with tangled thread may cause damage.

Changing the speaker volume

The volume of operation sounds can be changed.

The speaker volume can be set to "OFF" or a setting between "1" and "5". When "OFF" is selected, no sound is produced from the speaker.

When the embroidery machine is purchased, "3" is selected.

The speaker setting can be specified from page 3 of the settings screen.

- 1 Touch - and + to select the desired speaker volume.

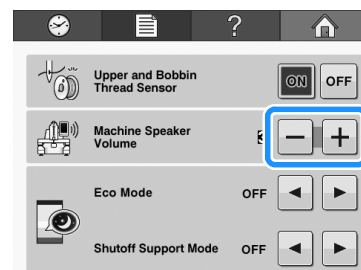

- Check that the desired speaker volume is selected with the operation sound produced when a key is touched.

Selecting the “Eco Mode” or “Shutoff Support Mode”

You can save the machine power by setting the eco mode or the shutoff support mode.

If you leave the machine without using for a specified period of time, the machine enters in one of these modes.

“Eco Mode”;

Machine will enter a sleep mode. Touch the screen or “Start/Stop” button to continue embroidering.

“Shutoff Support Mode”;

Machine will turn off after set period of time. Turn machine off and then back on to restart embroidering.

Condition	Eco Mode	Shutoff Support Mode
Available time	OFF, 0 - 120 (minute)	OFF, 1 - 12 (hour)
“Start/Stop” button	Green flashing	Green slow flashing
Suspended function	Machine light, Screen display, LED pointer	All functions
After recovering	The machine starts from the previous operation.	You need to turn off the machine.

Press the “Start/Stop” button or touch the screen display to recover from these modes.

These settings can be specified from page 3 of the settings screen.

- 1 Use ◀ or ▶ to select the time until entering the mode.

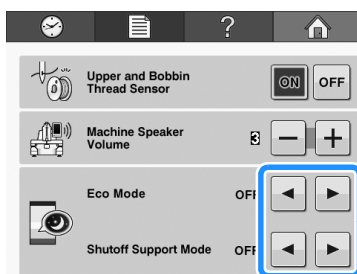

Note

- If you turn off the machine while the machine is in the “Eco Mode” or the “Shutoff Support Mode”, wait for about 5 seconds before turning on the machine again.

Setting the opening screen

You can select the initial screen of the machine. If you set the “Opening Screen” to “ON”, the opening movie screen starts when the machine is turned on. The initial pattern type selection screen appears after touching the screen.

If you set the “Opening Screen” to “OFF”, the initial pattern type selection screen appears when the machine is turned on.

When the embroidery machine is purchased, “ON” is selected.

The opening screen setting can be set from page 3 of the settings screen.

- 1 Touch ON or OFF to select the desired setting.

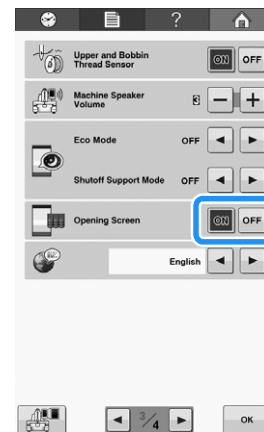

Changing the language

The language setting can be specified from page 3 of the settings screen.

- 1 Touch ◀ and ▶ to select the desired language.

The desired language is displayed.

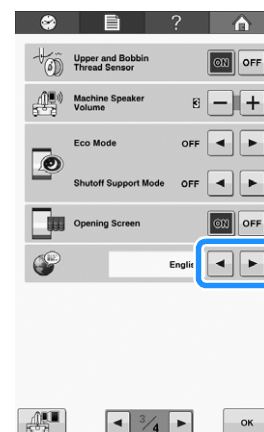

Turning “ON” or “OFF” the light

You can turn on or off the machine light.

When the machine is purchased, “ON” is selected.

The light can be specified from page 4 of the settings screen.

- 1 Touch **ON** or **OFF** to select the desired setting.

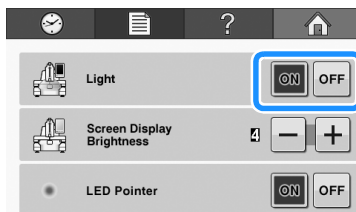

Changing the screen brightness

The screen display brightness can be set between “1” and “6”. The screen will be dimmed if you set to smaller number.

When the embroidery machine is purchased, “4” is selected.

The Screen display brightness setting can be specified from page 4 of the settings screen.

- 1 Touch **−** and **+** to select the desired screen brightness.

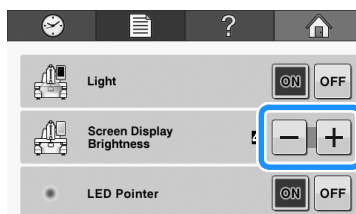

Setting the LED pointer

You can set the “LED pointer” to “ON” or “OFF”. The LED pointer shows the needle drop position in the embroidering screen when “ON” is selected. When “OFF” is selected, the LED pointer is lit off in any screen. Refer to “Embroidery positioning marker” on page 40 about the LED pointer.

When the embroidery machine is purchased, “ON” is selected.

The LED pointer setting can be set from page 4 of the settings screen.

- 1 Touch **ON** or **OFF** to select the desired setting.

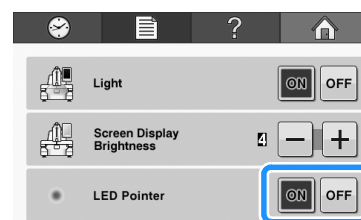

Using the Machine Operations Guide Key

This machine contains information based on the contents of the Operation Manual, such as basic machine operations. Touch  (machine operations guide key), and then select from the four topics that appear to display the available information.

■ Contents of Categories

Principal Parts

Displays and explains principal parts of the machine and their functions.

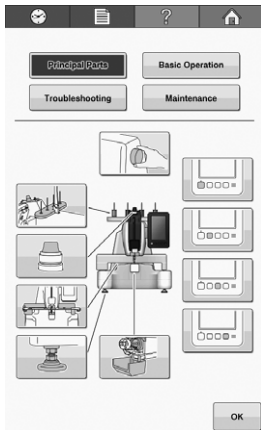

Basic Operation

Illustrates basic threading and hooping instruction.

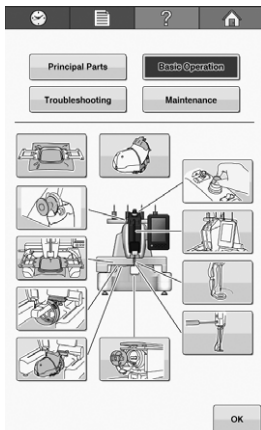

Troubleshooting

Basic guide for problems solving.

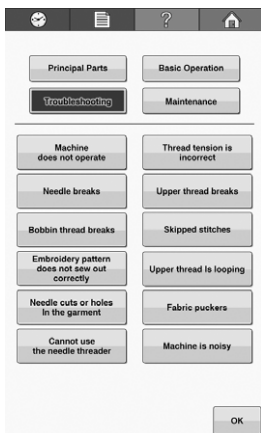

Maintenance

Instruction for maintaining your machine.

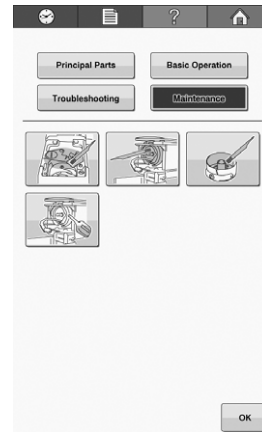

Example: To learn how to thread the upper thread

1 Touch .

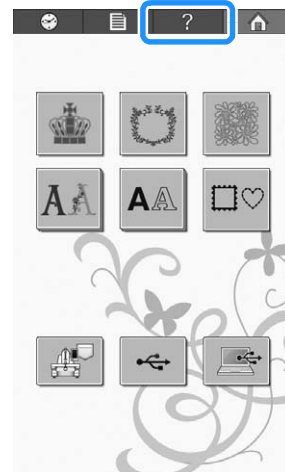

→ The machine operations guide screen appears.

2 Touch .

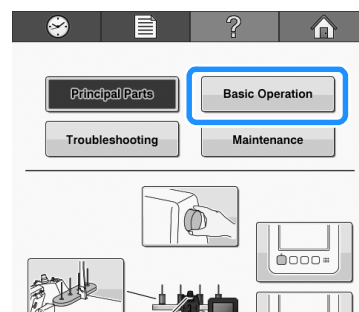

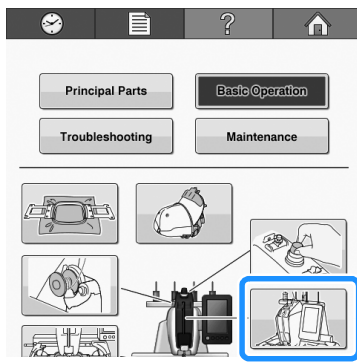

→ The list of basic operations appears.

3 Touch .

→ The procedure for threading the upper thread appears.

4 Read the instruction.

- * Press  to view the next page.
- * Press  to view the previous page.

5 Touch  to return to the original screen.

Chapter 7

APPENDIX

This chapter provides descriptions of techniques for sewing applications, pointers for creating beautiful embroidery, and details on maintenance procedures and corrective measures that should be taken when a problem occurs.



Appliqué Sewing.....	154
Sewing appliqué patterns	154
■ Procedure for sewing appliqués	154
Using a frame pattern to create appliqués (1)	155
Using a frame pattern to create appliqués (2)	156
Embroidering Split Embroidery Patterns.....	157
Helpful Tips for the Operation of the Machine	159
Color thread table	159
Colors of Tajima (.dst) embroidery data.....	159
Creating Beautiful Embroidery	160
Threads	160
Stabilizers (backing)	161
Hooping techniques	162
■ Frame Basics.....	162
Fabric/stabilizer compatibility chart	163
Maintenance.....	164
Cleaning the LCD	164
Cleaning the machine surface	164
Cleaning the hook	164
Cleaning around the needle plate	165
Cleaning the bobbin case	166
Cleaning the thread paths of the upper threads	166
■ Cleaning the thread guides.....	166
■ Disassembling and cleaning the tension unit	167
Oiling the machine	168
■ Oiling the race	168
■ Oiling the needle bar.....	169
About the maintenance message	169
Troubleshooting	170
Troubleshooting	170
Error messages	177
If the machine does not respond when a key is pressed.....	182
Specifications	183
Embroidery machine specifications.....	183
Upgrading Your Machine's Software	184
Upgrade procedure using USB media	184
Upgrade procedure using computer	185
Index	186

Appliqué Sewing

This section describes the procedure for sewing appliqués.

Sewing appliqué patterns

Some of the built-in embroidery patterns can be used for sewing appliqués. Follow the procedures described below to sew appliqués using the patterns with “APPLIQUE MATERIAL”, “APPLIQUE POSITION” or “APPLIQUE” in the region display at the top of the thread color sequence display.

- * Depending on the thread color display setting, the display may appear as  (APPLIQUE MATERIAL),  (APPLIQUE POSITION) or  (APPLIQUE).

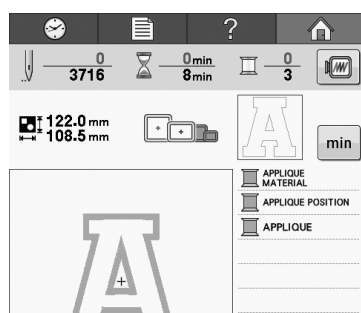

■ Procedure for sewing appliqués

- 1 Place stabilizer on the back of the appliqué fabric/material.
- 2 Frame the fabric for the appliqué (from step 1) in the embroidery frame, and then embroider an “APPLIQUE MATERIAL” pattern. The line that indicates where the appliqué will be cut out is embroidered, and then the machine stops.

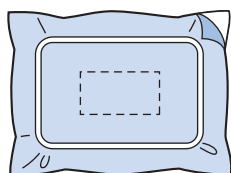

- 3 Remove the appliqué fabric from the embroidery frame, and then carefully cut along the embroidered cutline.

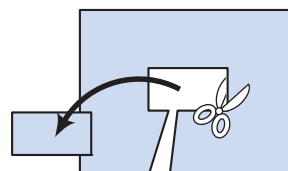

- If the appliqué is cut out along the inside of the embroidered cutline, the appliqué may not be correctly attached to the fabric. Therefore, carefully cut out the appliqué along the embroidered cutline. If this step is not performed carefully, the appliqué will not be cleanly finished. In addition, carefully remove any excess threads.

- 4 Frame the base fabric or garment in the embroidery frame, and then embroider an “APPLIQUE POSITION” pattern. The appliqué position is embroidered, and then the machine stops.

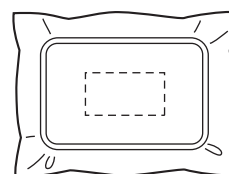

- 5 Lightly apply fabric glue or spray adhesive to the back of the appliqué piece that was cut out, and then attach the appliqué piece to the base fabric at the position embroidered using the “APPLIQUE POSITION” pattern in step 4.

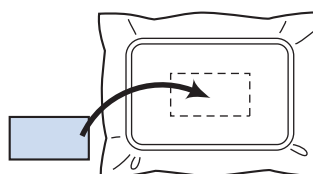

- If an iron-on stabilizer is used to attach the appliqué piece to the base fabric, iron the pieces together without removing the base fabric from the embroidery frame.

- 6** After attaching the appliqué piece, embroider an “APPLIQUE” pattern. The appliqué is finished.

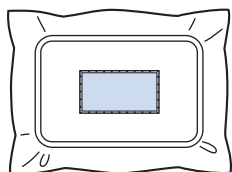

- Depending on the pattern, an “APPLIQUE” pattern may not be available. In this case, embroider the appliqué using thread in the color of a part of the embroidery.

- 7** Finish embroidering.

Using a frame pattern to create appliqués (1)

Appliqués can be created by embroidering two frame patterns of the same size and shape—one embroidered with straight stitches and the other embroidered with satin stitches.

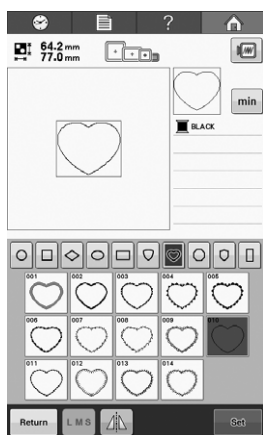

- 1** Select a frame pattern sewn with straight stitches to embroider onto the fabric for the appliqué. Carefully cut outside of the stitching.

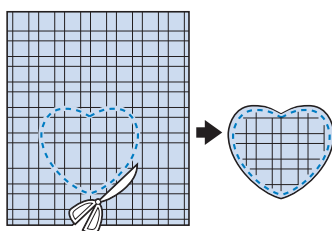

- 2** Embroider the same pattern on the base fabric.

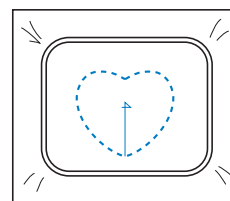

- 3** Lightly apply fabric glue or spray adhesive to the back of the appliqué piece that was cut out in step 1, and then attach the appliqué piece to the base fabric.

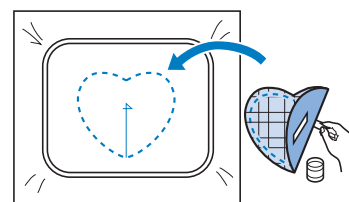

- 4** Select the satin-stitched frame pattern with the same shape to embroider the appliqué attached in step 3.

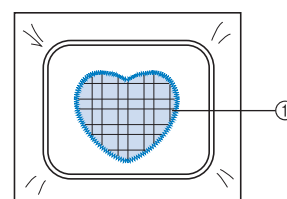
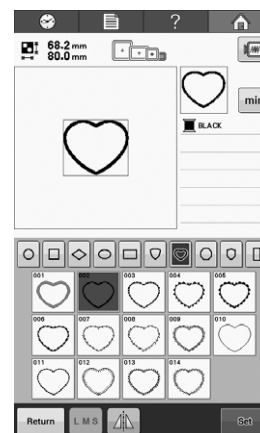

- ① Appliqué



Note

- If the size or position of the straight-stitched frame pattern is changed, be sure to change the size or position of the satin-stitched frame pattern in the same way.

Using a frame pattern to create appliqués (2)

There is another way of embroidering appliqués. With this method, there is no need to change the fabric in the embroidery frame. The appliqué can be created by embroidering two frame patterns of the same size and shape—one with straight stitches and the other with satin stitches.

- 1 Select a frame pattern with straight stitches to embroider onto the base fabric.

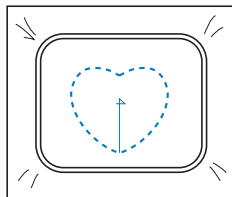
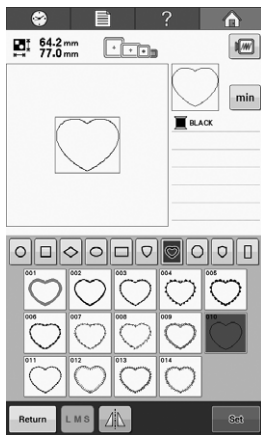

- 2 Place the appliqué fabric over the straight stitch embroidery in step 1. Make sure that the area surrounded by the stitching is not larger than the area of the appliqué fabric.

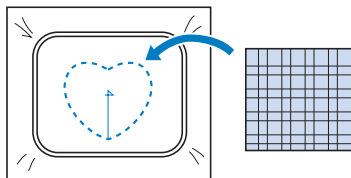

- 3 Embroider a second time over the appliqué fabric using the same frame pattern in a straight stitch.

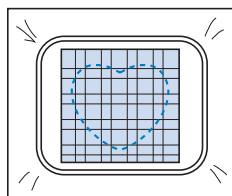

- Be sure to stop the machine before the cross at the center is embroidered.

- 4 Remove the embroidery frame from the machine, and then cut off the excess appliqué fabric along the outside of the stitching.

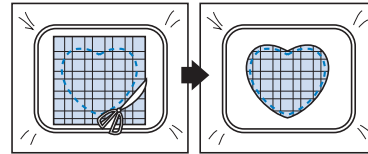

Note

- Leave the fabric in the embroidery frame when cutting off the excess appliqué fabric. In addition, do not apply extreme pressure to the framed fabric, otherwise the fabric could become loose.

- 5 Select the satin-stitched frame pattern with the same shape.

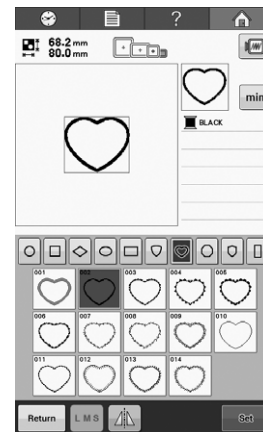

Note

- If the size or position of the straight-stitched frame pattern is changed, be sure to change the size or position of the satin-stitched frame pattern in the same way.

- 6 Attach the embroidery frame removed in step 4, and then finish embroidering the appliqué.

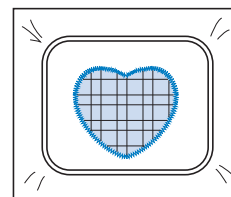

Embroidering Split Embroidery Patterns

Split embroidery patterns created with PE-DESIGN Ver.7 or later, or PE-DESIGN NEXT can be embroidered. With split embroidery patterns, embroidery designs larger than the embroidery hoop are divided into multiple sections, which combine to create a single pattern after each section is embroidered.

For details on creating split embroidery patterns and for more detailed sewing instructions, refer to the Instruction manual included with PE-DESIGN Ver.7 or later, or PE-DESIGN NEXT.

The following procedure describes how to read the split embroidery pattern shown below from USB media and embroider it.

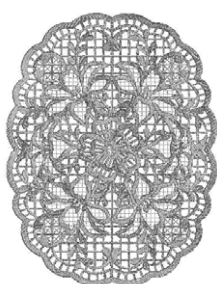



1 Connect to the machine the media containing the created split embroidery pattern, and then select the split embroidery pattern to be embroidered.

- * For details on recalling patterns, refer to “Embroidery cards (optional)” on page 112, “Recalling from USB media” on page 116, or “Recalling from the computer” on page 117.



→ A screen appears so that a section of the split embroidery pattern can be selected.

2 Select section to be embroidered.

- * Select the sections in alphabetical order.
- * A maximum of 9 sections can be displayed in one page. If there are 10 or more sections in the pattern, press  or  to display the previous or next page.

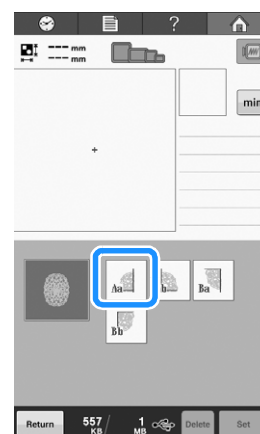

3 Touch .

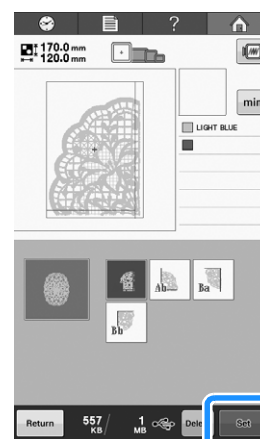



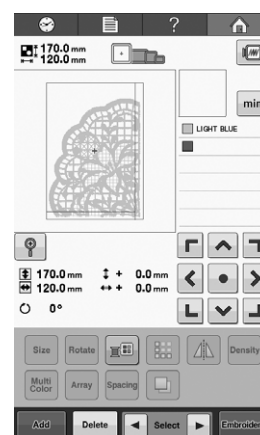

4 If necessary, edit the pattern.



- * For details, refer to “Editing the Embroidery Pattern (Pattern Editing Screen)” on page 119.

Memo

- The pattern can be rotated 90° to either the left or right when  is touched.

- 5 Touch .
- 6 Touch  to unlock the embroidery machine.
- 7 Touch the “Start/Stop” button to embroider the pattern section.
- 8 When embroidering is finished, the following screen appears. Touch .

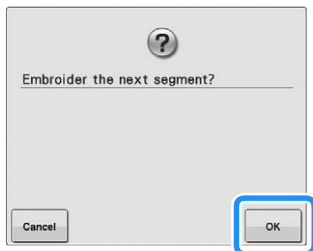

→ A screen appears so that a section of the split embroidery pattern can be selected.

- 9 Repeat steps [2](#) through [8](#) to embroider the remaining sections of the pattern.

Helpful Tips for the Operation of the Machine

This section provides descriptions to operations useful in the operation of this machine.

Color thread table

Additional explanations of the machine's built-in color thread table and the custom thread table are provided below.

Normally, the thread colors in the thread color sequence display and in the pattern display area are displayed in the colors of the machine's built-in color thread table. The thread color numbers with these thread colors are displayed with the thread color number (or the nearest number) for the brand specified on the first page of the settings screen. Therefore, the finished embroidery colors may have a slightly different tinge.

However, since the custom thread table specified on the change thread color screen in the pattern editing screen is created by specifying thread colors by the thread color numbers and color names by individual brands in the machine's built-in color library, the thread table is displayed with those original thread colors.

If pattern colors changed using custom thread table, pattern can be previewed with colors nearest to the actual embroidered thread colors.

Create color thread tables from the colors of threads that you have and use them to display the patterns in your own thread colors. Remember to save your Custom Thread Table before you create a new one.

Refer to "Creating a custom thread table" on page 132, and "Choosing a color from the custom thread table" on page 135 for the change thread color function.

Normal thread color display

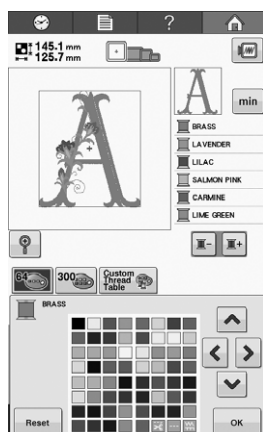

Thread color display using a custom thread

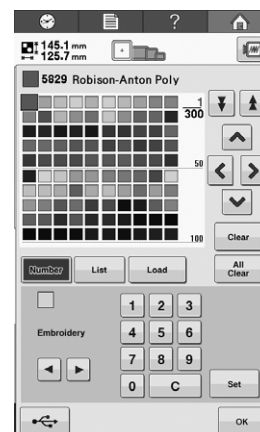

Colors of Tajima (.dst) embroidery data

Tajima data (.dst) does not contain pattern color information. The data is created by combining only shapes.

For example, the following embroidery data appears as shown below in the Tajima format (.dst)

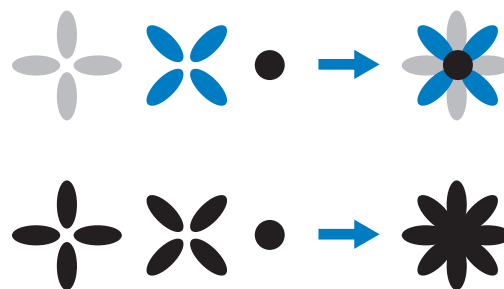

In order for the parts of the pattern to be differentiated when Tajima data is used with this machine, the pattern is displayed with colors automatically applied in the default thread color sequence. Since the thread colors are applied according to the embroidering order of the parts, regardless of the design of the pattern, colors may be applied that seem unusual for the design, for example, an orange-colored fruit may be displayed in blue.

When using Tajima data, be sure to preview the embroidered image on the screen and change the colors from the change thread color screen.

Creating Beautiful Embroidery

The various precautions concerning the thread, embroidery frames and stabilizers (backings) that must be observed in order to create beautiful embroidery are described below.

Threads

Embroidery thread can be costly, therefore caring for it should be a priority. No matter how well a thread is manufactured, it must be appropriately stored if it is to sew properly. This is especially true when one considers the time that lapses between delivery to the thread user and the moment the thread is actually used on the embroidery machine. It is important that embroidery threads be stored in an environment that is free of damaging agents such as excessive heat, light or moisture.

Embroidery threads are best stored in an area that is as clean and dust-free as possible. It is also important that the storage area be free of smoke, fumes and gases. Certain gases may cause the thread to yellow. These fumes originate from such appliances as gas heaters or from gas or diesel engines.

Direct sunlight is also extremely destructive for embroidery threads. Boxes of thread should not be left open and exposed to direct sunlight. If possible, skylights and windows should be diffused. The best type of lighting for embroidery thread is tungsten-filament or fluorescent tubes. It is important to remember that prolonged exposure to these harmful sources may also cause the colors of cardboard boxes and other objects to fade.

Temperature and humidity also pose a threat to embroidery threads. The ideal conditions are between 59 °F and 77 °F (or 15 °C and 25 °C). Humidity should be between 40% and 60%. These conditions should be kept as constant as possible in order to prevent mildew from forming. Excessive temperatures can also cause lubrication problems that ultimately result in thread breaks. Damp conditions can affect paper bobbins as the cardboard will swell and the thread can become oversized. It is also important to realize that even if the overall storage conditions are good, there may be "spot problems" where a thread is exposed to a heat source or bright lights. Ensuring that thread does not become damaged requires that stock be frequently rotated and that threads are not left in the same place for an extremely long time.

Choice of thread is a major factor in improving production time. The thread run ability, strength, consistency and weight all affect output. These qualities determine how well the machine will sew and the number of thread breaks during sewing.

Stabilizers (backing)

Backing and topping serve to stabilize and support the product being embroidered so the stitches can be sewn with the least amount of interference or instability. They serve as stabilizers for your embroidery work. Without the proper type of stabilizer, the fabric may move too much within the embroidery frame causing poor alignment of the embroidery. At times, topping will be required in order to manage fabrics with a pile-like surface, such as towels, corduroy and pique knit. There are many types of backing and toppings with various weights for the various fabrics that you may be sewing.

There are four types of stabilizers (backing) that can be used in embroidery: cut-away, tear-away, water soluble and self-adhesive. In these four types, various weights, sizes and textures are available. When selecting the stabilizer type for a particular fabric, consider the pattern size in addition to the stitch count and stitch type used in the pattern.

Finally, make sure that the stabilizer is not stretched. Some backings may not stretch vertically or horizontally but may stretch diagonally. **DO NOT USE THESE TYPES.** This type of backing will stretch during sewing and may cause the pattern to shift.

1. Polyester mesh cut-away stabilizer works extremely well with light-colored fabrics since it prevents a shadow from showing through on the front after you have trimmed away the excess. This type of backing is ideal whenever you need stability with a light and soft touch in your finished product, for example, with baby garments.

2. Cut-away stabilizer is excellent for medium- to heavyweight knits, however it can also be used on woven material. It will hold a large number of stitches and with two or three layers can hold a tremendous amount of stitches. This type of backing is also available in black for those who want the inside of their garments to look as good as the outside. Black stabilizer is very useful on similarly colored garments of lightweight fabrics. The black backing is less likely to show through as compared to white backing.

3. Self-adhesive (peel-and-stick) backing is used on those difficult-to-hoop fabrics. This backing is applied (with sticky side up) to the underside of the frame, enabling your fabric to “stick on” the exposed surface in the embroidery area. When the

embroidery is finished, the fabric can be removed, the excess backing can be disposed of and the process repeated.

4. Tear-away stabilizer can be used on mediumweight woven fabrics and sturdy fabrics such as canvas, poplin and denim. This stabilizer will hold many stitches especially when used in two or more layers. This type of stabilizer is made of a non-woven material that enables it to easily be torn away from the edges of your embroidery design when it is completed. This stabilizer is also available in black.

5. Water-soluble stabilizer is useful when you need to keep the nap or pile, for example, on towels, from interfering with the placement of stitches. Fabrics such as terry cloth, corduroy, velvet and faux fur are examples of materials that have a nap or pile that can actually penetrate embroidery stitches as your machine sews. The result is an unfinished and often sloppy appearance when fibers of the fabric poke out between the finished stitches of an embroidery design. In these situations, water-soluble stabilizer is used as a topping to hold the fibers of the fabric flat so the stitches can be placed on top neatly and accurately. Water-soluble stabilizer is also used as a backing when stitching lace or other motifs where the desired result is only the stitching. This is accomplished with water-soluble stabilizer, which can easily be pulled off of the fabric after embroidering is completed and any remnants can easily be dissolved with water. Water-soluble stabilizer is also used as a backing on towels, where you often need some stabilization, but any remnants of a formal backing must not be visible in the finished product.

Hooping techniques

“Use the right tool for the right job” is a statement many of us have heard throughout the years. This statement holds true even in the embroidery industry. The wrong size or type of embroidery frame may result in poor pattern alignment during sewing or damage the product altogether. You can take a perfectly created design and ruin the final results by simply not using the correct frame size, type or technique designed for its application.

■ Frame Basics

Tubular frames: This type of frame allows tubular fabric or pre-assembled garments to be placed around the hook assembly. It allows embroidering of the front of a garment without stitching through the back of it. Remember to rotate your embroidery pattern when you have hooped a T-shirt from the bottom up so that it can be placed around the hook area.

Cap frames: These are specialized embroidery frames (hoops) designed to hold caps for embroidering. They are available in a variety of styles for various machines, with two basic styles: one that allows sewing a flattened cap (for use on a flat machine) or one that allows sewing the cap in its natural curved shape (for use on a tubular machine).

Hooping fabric: The framed fabric and backing should be perfectly flat and free of wrinkles or bubbles. If there are bubbles or wrinkles that must be removed, be sure that you pull on the fabric and backing together. Pull no more than is necessary to make the fabric flat and smooth. Overstretching the fabric during this process may cause puckers around the finished design when the frame is removed. Gaps may also be generated between design parts.

Inner/outer frame positioning: There should be a slight ridge (3 mm (1/8 inch)) of fabric and backing below the outer frame on the back side. Tighten the screw only if the inner frame feels loose. Avoid overtightening the screw as this will cause puckers in the fabric and may “strip” the screw.

Fabric/stabilizer compatibility chart

Fabric/ Garment	No. of Backing Pieces	No. of Topping Pieces	Comments
Terry cloth	1 tear-away	1 water-soluble	Increase density and/or satin stitch width. Fine details and small lettering tend to get caught in the terry loops.
Satin jacket	Heavy lining: None Light or no lining: 1 tear-away	None	If garment slips in frame, causing alignment problems, wrap inner frame with masking tape or fabric bias tape. This provides a rough surface to grip garment and also helps minimize frame burn.
Cotton sheeting	1 tear-away	None	High-density or highly detailed patterns may require more backing. If so, use two pieces of lightweight backing instead of one piece of heavy backing.
Denim	1 tear-away	None	Reduce speed if needle begins to heat up and the thread breaks.
Headwear	Optional	Optional	Change needles more often than usual because the buckram backing dulls needles faster. A lightweight tear-away backing helps reduce thread breaks and regulates thread tension. Use a topping on corduroy or foam cap fronts.
Dress shirt (woven)	1 tear-away	None	High-density or highly detailed patterns may require more backing. If so, use two pieces of lightweight backing instead of one piece of heavy backing.
Golf shirt	1 cut-away	Optional	Use topping for patterns containing small lettering or a lot of detail, and also for pique knits.
Canton fleece	1 tear-away	Optional	Use a topping if the garment has a textured surface, such as a basketweave or pronounced twill.
Canvas	1 tear-away	None	Frame tightly.
Corduroy	1 tear-away	1 water-soluble	A higher stitch density or more understitches, as well as a topping, may be necessary to prevent stitches from sinking into the fabric.
Lingerie or silk	1 or 2 lightweight tear-away	Optional	Reduce embroidering speed. The thread tension should be low. Use topping for patterns with high detail or small lettering. For very fine fabrics, use a thinner thread. Avoid extremely narrow satin stitching on letters or details; instead increase satin stitch width or use a bean stitch. Gently remove (don't pull) backing and topping from garment.
Sweater knit	1 cut-away or adhesive tear- away	1 water-soluble	Use tightly woven organza or curtain fabric in a matching color as a backing for bulky or "holey" knits.
Sweatshirt	1 cut-away or adhesive tear- away	Optional	Highly detailed patterns may require two layers of lightweight cut-away stabilizer. Use a topping on extra-thick fabrics or with fine-detail patterns.
T-shirt	1 light-weight cut-away or adhesive tear- away	Optional	Use a topping on patterns with fine detail or small lettering. Tensions should be light. Avoid stitch-heavy patterns.



Note

- Due to the wide variety of fabrics and stabilizers available, the above information should be used as guideline only. If unsure of a particular fabric/stabilizer combination, please sew test a sample prior to the finished garment.

Maintenance

Simple embroidery machine maintenance operations are described below. Always keep the machine clean, otherwise malfunctions may occur.

Cleaning the LCD

If the surface of the LCD is dirty, lightly wipe it with a soft dry cloth. Do not use organic cleansers or detergents.

Cleaning the machine surface

If the surface of the machine is slightly dirty, wipe it with a soft dry cloth. If the machine is heavily dirty, lightly soak a cloth in neutral detergent, squeeze it out firmly, and then wipe the surface of the machine. After cleaning it once with a wet cloth, wipe it again with a dry cloth.

⚠ CAUTION

- Unplug the power supply cord before cleaning the machine, otherwise injuries or an electric shock may occur.



Note

- Do not use chemical products, such as benzene or thinner.

Cleaning the hook

Periodically remove lint and dust for better performance from hook race area.

Use the included cleaning brush.

- 1 Turn off the embroidery machine.

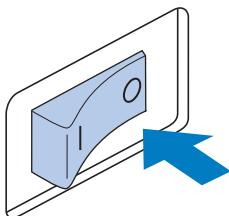

⚠ CAUTION

- Unplug the power supply cord before cleaning the machine, otherwise injuries or an electric shock may occur.

- 2 Open the hook cover, and remove the bobbin case. (Refer to page 32.)

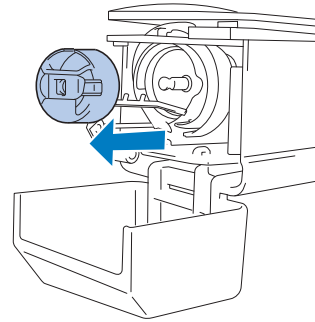

- 3 Use the included cleaning brush to remove any lint and dust from the hook and its surrounding area.

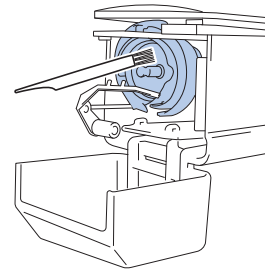

⚠ CAUTION

- If the hook is scratched or damaged, consult your authorized Brother dealer.

- 4 After cleaning is finished, insert the bobbin case into the hook, and then close the hook cover. (Refer to page 33.)

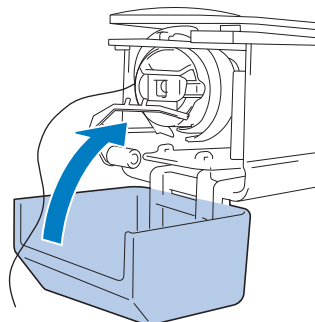

Cleaning around the needle plate

If lint and dust collect around the moving knife, the fixed knife or the thread retaining plate, the thread may not be cut correctly and the error message may appear, or various parts of the machine may be damaged. Make sure to clean around the needle plate once a month.

Use an offset screwdriver and the included cleaning brush.

- 1 Turn off the embroidery machine.

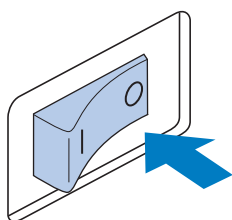

⚠ CAUTION

- Unplug the power supply cord before cleaning the machine, otherwise injuries or an electric shock may occur.

- 2 Remove the needle plate.

With an offset screwdriver, loosen the screws, and then remove the needle plate.

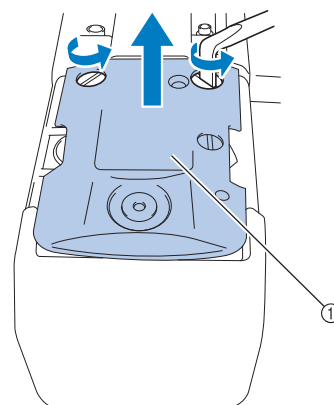

① Needle plate

- 3 Use the included cleaning brush to remove any lint and dust from the moving knife, the fixed knife, the thread retaining plate, and their surrounding areas.

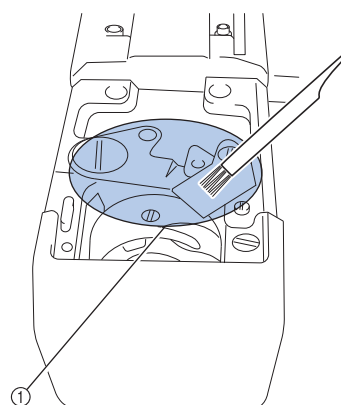

① Remove all lint in this area

- 4 After cleaning is finished, attach the needle plate in the opposite way that it was removed in step 2.

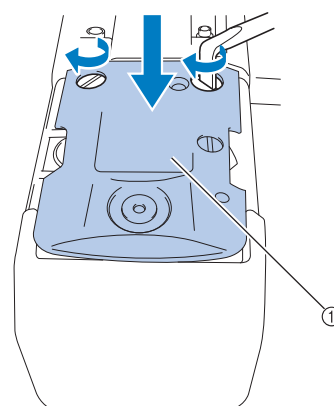

① Needle plate

Cleaning the bobbin case

Thread wax and dust easily collect around the hole in the tension-adjusting spring on the bobbin case, resulting in an incorrect thread tension. Therefore, it should be cleaned each time when the bobbin is changed.

Use a piece of paper with the thickness of a business card.

- 1 Open the hook cover, remove the bobbin case, and then remove the bobbin. (Refer to page 32.)

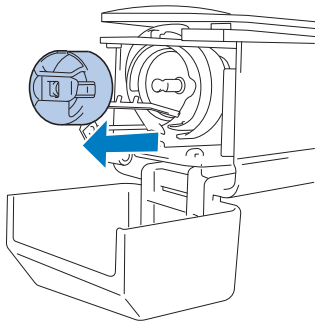

- 2 Slide the paper under the tension-adjusting spring to remove any dust.

Use a corner of the paper to remove any dust from around the hole.

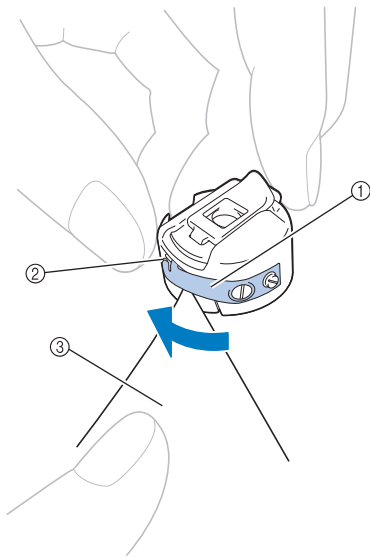

- ① Tension-adjusting spring
- ② Hole
- ③ Paper



Note

- Do not bend the tension-adjusting spring. In addition, do not use anything other than thick paper or paper of the specified thickness to clean the bobbin case.

- 3 Use the included cleaning brush to remove any lint and dust from inside the bobbin case.

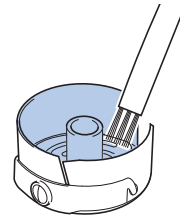

- 4 After cleaning is finished, insert the bobbin into the bobbin case and the bobbin case into the hook, and then close the hook cover. (Refer to page 33.)

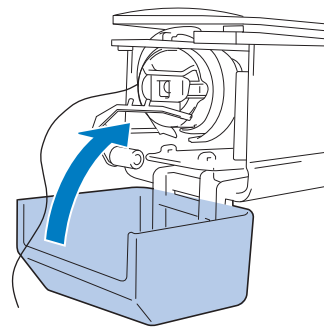

Cleaning the thread paths of the upper threads

If dust or lint has accumulated in the thread guides or tension unit in the paths of the upper threads, the thread may break while embroidery is being sewn. Periodically clean the thread paths.

■ Cleaning the thread guides

- 1 Use the included cleaning brush to remove any lint and dust from below the thread guide plates.

Clean the thread guide plates for both the upper thread guides and the middle thread guides.

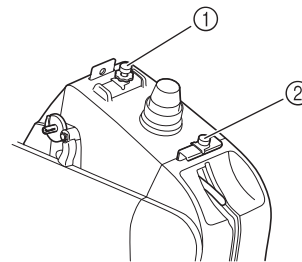

- ① Upper thread guide
- ② Middle thread guide

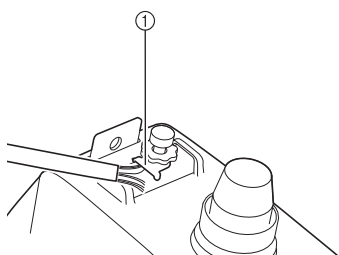

① Thread guide plate

■ Disassembling and cleaning the tension unit

- 1** To remove tension dial, turn dial counterclockwise as shown on illustration.

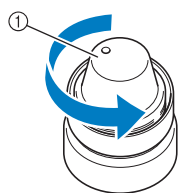

① Tension dial

- 2** Using the included cleaning brush, remove any lint and dust from the two pieces of felt washers (top, bottom) inside the tension dial.

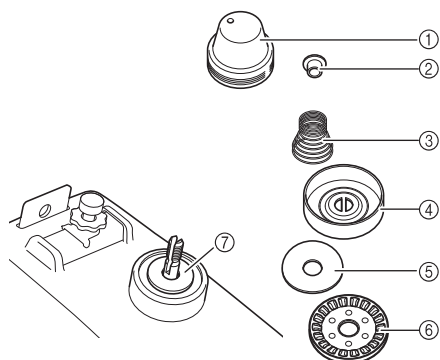

- ① Tension dial
 ② Nylon shoulder washer
 ③ Tension spring
 ④ Tension base spring
 ⑤ Felt washer (top)
 ⑥ Tension disc
 ⑦ Felt washer (bottom)

3 Reassembling the tension unit.



Note

- When reassembling the tension unit, be sure not to install the tension disc upside-down. There is a magnet on the bottom.

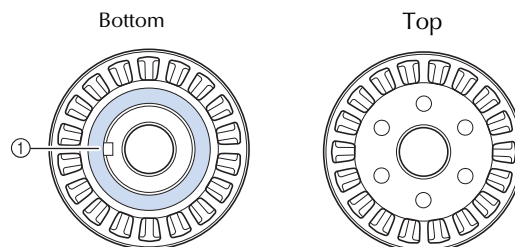

① Magnet

- When reassembling the tension unit, be careful not to lose any parts or install any parts in an incorrect order. The machine may not operate correctly if the tension units are incorrectly reassembled.

Oiling the machine

In order to extend the life of the embroidery machine's parts and keep the machine operating correctly, be sure to oil the machine before the first time that it is used. If too little oil was applied to the race, an error message may appear. Afterward, put a drop of oil onto the hook once a day before use, and put a drop of oil to the lower needle bar felt washer every 40 to 50 hours of machine use.

■ Oiling the race

- 1 Turn off the embroidery machine.

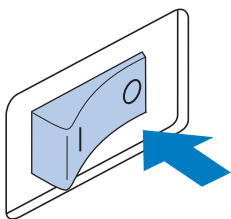

⚠ CAUTION

- Unplug the power supply cord before cleaning the machine, otherwise injuries or an electric shock may occur.

- 2 Open the hook cover, and remove the bobbin case. (Refer to page 33.)

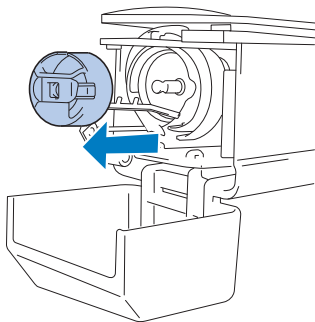

- 3 Rotate the handwheel to a position (△) on the machine.

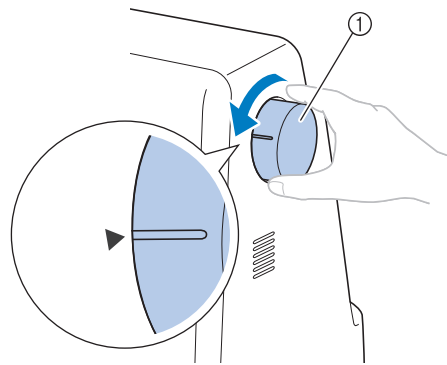

- ① Handwheel

- Be sure to rotate the handwheel toward the LCD panel (counterclockwise).

- 4 Put a drop of oil onto the hook.

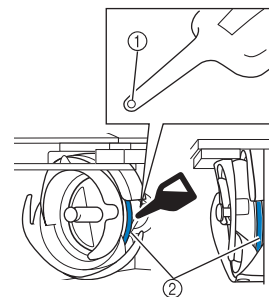

Front angle view

Side view

- ① Punch a small hole in oil bottle.

- ② Apply oil here.

- Use a pointed object to punch a small hole in the tip of the included oiler before using it.

- 5 After oiling, insert the bobbin case into the hook, and then close the hook cover. (Refer to page 32.)

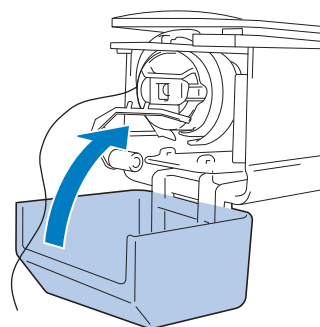

■ Oiling the needle bar

Put one drop of oil on the lower needle bar felt washer.

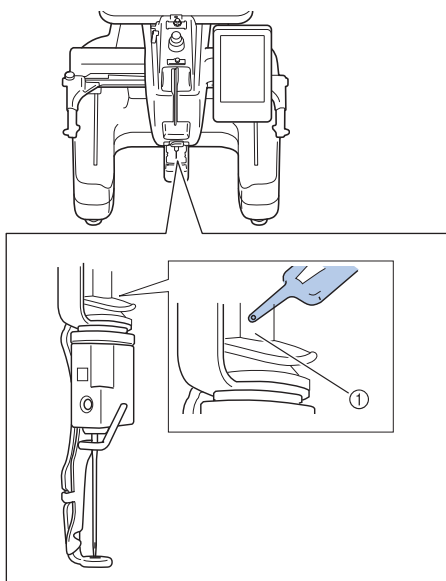

- ① Apply oil here.
- Too much oil may drip onto sewing project.



Note

- Put a drop of oil onto the hook once a day before use.
- Apply one drop of oil on the lower needle bar above the felt washer every 40 – 50 hours of embroider time.
- Apply only sewing machine oil. Use of any other type of oil may result in damage to the embroidery machine.
- Do not apply too much oil. Fabric or thread may become contaminated. If too much oil is applied, wipe off any excess with a rag.
- If the thread breaks while embroidering or the operating noise of the hook becomes loud, apply oil onto the race hook.

About the maintenance message



Once this message appears, it is recommended to take your machine to an authorized Brother dealer for a regular maintenance check. Although this message will disappear and the machine will continue to function once you touch , the message will display several more times until the appropriate maintenance is performed.

Please take the time to arrange the maintenance your machine requires once this message appears. Such steps will help to ensure you receive continued, uninterrupted hours of machine operation for the future.

Troubleshooting

Troubleshooting

If the machine does not operate correctly, check for the following points/issues before requesting service. If the suggested remedy does not correct the problem, contact your authorized Brother dealer.

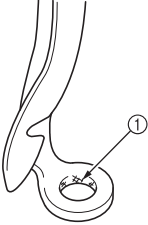
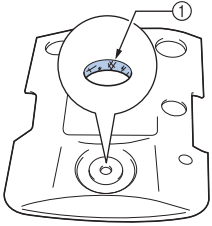
Symptom	Probable Cause	Remedy	Reference Page
The embroidery machine does not operate.	The machine is not turned on.	Turn on the embroidery machine.	p. 28
	The machine has not been unlocked.	Touch the unlock key.	p. 54
	The "Start/Stop" button was not pressed.	With the machine unlocked, press the "Start/Stop" button.	p. 54
The needle breaks.	The needle is not installed correctly.	Correctly install the needle.	p. 72
	The needle set screw is loose.	Use the Allen screwdriver to securely tighten the needle set screw.	p. 72
	The needle is bent or blunt.	Replace the needle with a new one.	p. 25, 72
	The area around the embroidery foot hole is damaged.  ① Scratches or Burrs	Replace the presser foot. Consult your nearest authorized Brother dealer.	
	The bobbin or bobbin case are not correctly installed.	Remove and reinstall bobbin and bobbin case.	p. 32, 33
	The upper thread is not threaded correctly. The upper thread is catching somewhere.	Pull the upper thread by hand from below the presser foot, and check that the thread moves smoothly. If the thread does not move, it is not threaded correctly. Thread the upper thread correctly. Make sure the thread is caught by the needle bar thread guide.	p. 48-51
	The upper thread tension is set too high. It does not run.	Decrease the upper thread tension and make sure tension disc rotates when pulling on thread.	p. 92
	The area around the hole in the needle plate is damaged.  ① Scratches/Burrs	Replace the needle plate. Consult your nearest authorized Brother dealer.	

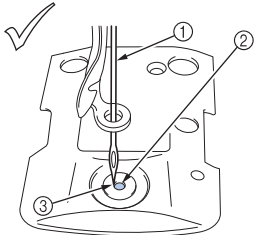
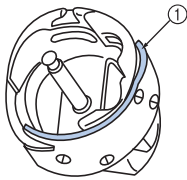
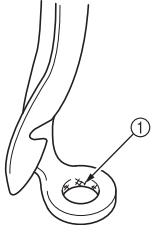
Symptom	Probable Cause	Remedy	Reference Page
The needle breaks.	<p>The needle hits/touches the needle plate.</p>  <p>① Needle ② Hole in needle plate ③ Needle hits hole</p>	Replace or consult your nearest authorized Brother dealer.	p. 72
	<p>The presser foot is set too high and not correctly positioned. The needle hits/touches the presser foot.</p>	Consult your nearest authorized Brother dealer.	
	<p>Sliding surface on hook race is not smooth. There are scratches or burrs on it.</p>  <p>① Hook race area</p>	Consult your nearest authorized Brother dealer.	
	The hook is not correctly installed.	Consult your nearest authorized Brother dealer.	
	The hook stopper is not correctly installed, the hook is making a complete rotation.	Consult your nearest authorized Brother dealer.	
	A bobbin designed specifically for this machine is not used.	Use the correct bobbin.	p. 26
	The needle and the hook are not correctly passing each other.	Hook timing may be OFF. Consult your nearest authorized Brother dealer.	
	The thread density of the embroidery data is too fine. Three or more overlapping stitches are being sewn.	Using a data design system, correct the thread density and over stitching settings in the embroidery data.	p. 104
	Spool cap is set incorrectly.	Check the method for attaching the spool cap, then reattach the spool cap.	p. 49
	Bobbin thread is incorrectly wound.	Use a correctly wound bobbin.	p. 26
The upper thread breaks.	The needle is not correctly installed.	Correctly install the needle.	p. 72
	The needle is bent or blunt.	Replace the needle with a new one.	p. 25, 72
	The area around the embroidery foot hole is damaged.  <p>① Scratches/Burrs</p>	Replace the presser foot. Consult your nearest authorized Brother dealer.	
	There are knots or tangles in the thread.	Remove any knots or tangles.	
	The upper thread tension is too high.	Decrease the upper thread tension.	p. 92
	The bobbin case is damaged.	Replace the bobbin case with a new one.	p. 32
	A bobbin designed specifically for this machine is not used.	Use the correct bobbin.	p. 26
	The needle set screw is loose.	Use the Allen screw driver to tighten the needle set screw.	p. 72

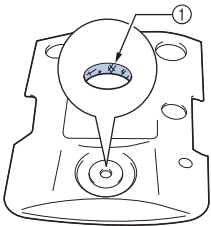
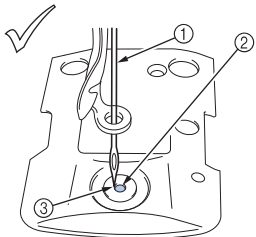
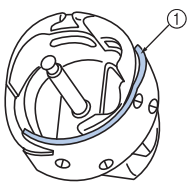
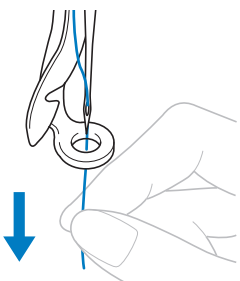
Symptom	Probable Cause	Remedy	Reference Page
The upper thread breaks.	<p>The area around the hole in the needle plate is damaged.</p>  <p>① Scratches/Burrs</p>	Replace the needle plate or consult your nearest authorized Brother dealer.	
	<p>The needle is touching the needle plate.</p>  <p>① Needle ② Needle plate hole ③ Needle touching hole</p>	Consult your nearest authorized Brother dealer.	
	<p>The presser foot is set too high and not correctly positioned. The needle hits/touches the presser foot.</p>	Consult your nearest authorized Brother dealer.	
	<p>Using a weak thread like a metallic thread.</p>	Slow down the machine embroidering speed.	p. 99
	<p>Sliding surface on hook is not smooth. There are burns on it.</p>  <p>① Hook race area</p>	Consult your nearest authorized Brother dealer.	
	<p>The thread is loose in the hook area.</p>	Remove the loose thread. If the thread is tangled in the hook, clean the hook.	p. 164
	<p>The play between the hook and the race is too much.</p>	Consult your nearest authorized Brother dealer.	
	<p>The hook does not rotate smoothly.</p>	Remove lint, clean and apply oil.	p. 164, 168
	<p>The space between the hook stopper and the hook cannot be adjusted.</p>	Consult your nearest authorized Brother dealer.	
	<p>The upper thread is not threaded correctly.</p> 	<p>Pull the upper thread by hand from below the presser foot, and check that the thread moves smoothly. If the thread does not move smoothly, it is not correctly threaded. Unthread the machine and rethread the machine. Make sure the thread is correctly positioned in the needle bar thread guide.</p>	p. 48-51
	<p>Upper thread is not positioned in upper or middle guide plate.</p>	Make sure thread passes completely under upper and middle guide plate.	p. 48-51
	<p>The lower thread tension is incorrect. The thread does not roll out of the bobbin case smoothly.</p>	Adjust the lower thread tension.	p. 91

Symptom	Probable Cause	Remedy	Reference Page
The upper thread breaks.	The bobbin thread is not wound correctly.	Check that the bobbin is wound so that it is about 80% full and that the thread is evenly wound. If the bobbin is not correctly wound, replace the bobbin with one that is correctly wound or rewind the bobbin.	p. 26
	The automatic threading mechanism is broken.	Consult your nearest authorized Brother dealer.	
	Adhesive is attached to the needle.	Replace the needle.	p. 72
	The fabric is not taut.	Firmly set the fabric in the embroidery frame so that it is taut.	p. 42, 77
	The thread quality is poor.	The thread quality is too weak due to age of thread. Replace thread.	
	The thread density of the embroidery data is too fine. Three or more overlapping stitches are being sewn.	Using a data design system, correct the thread density and over stitching settings in the embroidery data.	p. 104
The bobbin thread breaks.	The bobbin thread is not correctly threaded.	Correctly thread the bobbin thread.	p. 33
	The bobbin is scratched or does not rotate smoothly.	Replace the bobbin.	p. 32
	The thread is tangled.	Remove the thread jammed and clean the hook.	p. 164
	A bobbin designed specifically for this machine is not used.	Use the correct bobbin.	p. 26
	The bobbin case is damaged.	Replace the bobbin case.	p. 32
Stitches are skipped.	The upper thread is not threaded correctly.	Thread the upper thread correctly.	p. 48
	The needle is bent or blunt.	Replace the needle with a new one.	p. 25, 72
	The needle is not installed correctly.	Correctly install the needle.	p. 72
	Dust has accumulated under the needle plate or in the hook.	Clean the hook and the needle plate.	p. 164, 165
	The needle and the hook are not correctly passing each other.	Consult your nearest authorized Brother dealer.	
	The thread twist is either too tight or too loose.	Improper twisting results in irregular loop formation. Try using a new spool.	
The embroidery pattern is misaligned.	The thread is tangled.	Use tweezers to remove any tangled thread from the hook.	
	The fabric is not well framed in the embroidery frame (for example, the fabric is not taut).	If the fabric is not taut, the pattern may become misaligned or the stitching may shrink. Be sure to correctly frame the fabric in the embroidery frame.	p. 42, 77
	Stabilizer (backing) is not used.	Use stabilizer (backing) when embroidering on thin or stretch fabrics, fabrics with a coarse weave or fabrics that easily allow the stitching to shrink. <When using the optional cap frame> Use heavyweight stabilizer when embroidering on a cap made of soft material.	p. 76
	The carriage or the embroidery frame is hitting objects.	The pattern may become misaligned if the carriage or embroidery frame is hitting objects. Make sure that there are no objects within the operating field of the embroidery frame.	
	The fabric is caught or pinched.	Stop the machine, and then correctly position the fabric.	

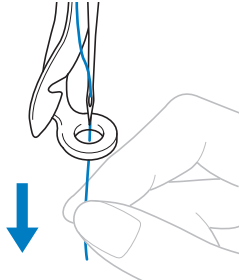
Symptom	Probable Cause	Remedy	Reference Page
The embroidery pattern is misaligned.	The carriage moved while removing embroidery frame.	The pattern may become misaligned if the presser foot was hit or the carriage was moved while replacing bobbin thread, changing needle, or working near embroidery frame. Be careful when removing and reattaching the embroidery frame while replacing bobbin thread, changing needle, or working near embroidery frame. If the carriage is moved, turn the machine off, then on again. The correct frame position at the time that the machine was stopped is stored in the machine's memory, and the embroidery frame is returned to the correct position.	
	The embroidery frame is too large for the size of the embroidery.	Use an embroidery frame that is close to the size of the embroidery.	p. 74
	The embroidery frame is not correctly attached to the carriage.	Correctly attach the embroidery frame to the carriage. Make sure that the pins on the left and right arms of the embroidery frame holder securely fit into the holes in the handles on the embroidery frame.	p. 44
	The pattern was not digitized correctly.	The pattern may need more pull compensation or underlay to accommodate stretchy or high-napped fabrics.	
	Stabilizer is incorrectly attached, for example, it is smaller than the embroidery frame.	Attach the stabilizer correctly.	p. 76
There are loops in the upper thread.	The upper thread tension is low.		p. 92
	The thread tension does not correspond to the amount that the thread tension knob or the upper thread guide pretension knob was tightened.	If the thread tension cannot be adjusted, dust may have collected in the upper or middle thread guide plates, causing the thread tension guide plates not to measure the thread weight properly. Clean the thread tension guide plates.	p. 167
	Thread is not correctly threaded around upper thread tension discs.	Clean upper thread tension disc. Rethread and make sure tension disc rotates when pulling on thread.	p. 167
	The thread quality is poor.	Try sewing with different thread. If the problem no longer occurs after the thread is changed, the thread quality is the problem. Replace the thread with one of good quality.	
	The lower thread tension is incorrect.	Adjust the tension of the bobbin thread.	p. 92
The machine is noisy.	Lint may be wound in the hook.	Clean the hook.	p. 164
	The upper thread is not threaded correctly.	Check the thread path, and then thread the upper thread again.	p. 48
	The hook is damaged.	Replace the hook. Consult your nearest authorized Brother dealer.	
	Not enough oil was applied.	Oil recommended parts.	p. 168

Symptom	Probable Cause	Remedy	Reference Page
The needle threader cannot be used.	The needle is not installed correctly.	Correctly install the needle.	p. 25, 72
	Recommended needles are not used on this machine.	Replace and use recommended needle.	p. 25, 72
	The hook on the automatic threading mechanism is bent.	Consult your nearest authorized Brother dealer.	p. 25, 72
	Needle is turned, bent or the point is dull.	Replace the needle.	p. 72
The thread tension is incorrect.	The upper thread is not threaded correctly.	Check the thread path, and then thread the upper thread again.	p. 48
	The bobbin thread is not correctly threaded.	Correctly thread the bobbin thread.	p. 33
	The lower thread tension is incorrect.	Adjust the tension of the bobbin thread.	p. 91
	Bobbin thread is incorrectly wound.	Use a correctly wound bobbin.	p. 26
	Needle is turned, bent or the point is dull.	Replace the needle.	p. 72
The upper thread does not reach the bobbin thread when embroidering begins.	There is no more thread in the bobbin, the thread does not feed from the bobbin, or the thread that is fed from the bobbin is too short.	Correctly thread the bobbin thread.	p. 33
Although the thread is not broken, a broken thread error occurs and the machine stops.	If the thread breakage sensor in the thread tension disc of the thread tension knob cannot detect that the thread is being fed, even if the machine is running, a broken thread error occurs and the machine is stopped. If the thread came out of the thread tension disc, even though the thread is not broken, the machine detects that the thread is not being fed and stops.	Clean the tension unit. Correctly pass the thread through the thread tension disc. If the broken thread error occurs after the machine is cleaned and rethreaded, the sensor may be damaged. Consult your nearest authorized Brother dealer.	p. 50, 167
There are needle cuts or holes in the garment.	The needle is dull.	Replace the needle. Dull needles have a difficult time passing through the garment, causing fabrics to tear.	p. 25, 72
	The fabric is too delicate.	The simple penetration of the needle could damage delicate fabrics. Use stabilizer on top of fabric.	p. 163
There is puckering in the fabric.	The thread tension is too tight.	Adjust the tension according to the type of fabric and thread being used. Polyester thread will stretch during sewing especially if the tensions are set too high. After the stitching is complete, the thread returns to its original strength, causing puckers in the fabric.	p. 92
	Needle is turned, bent or the point is dull.	Replace the needle.	p. 72
	The framing tension of the fabric is incorrect.	Tightly frame non-stretchable, woven fabrics. Loose framing will cause the fabric to bunch up under the stitching. Tautly frame soft knits using a stable backing. Overstretching the garment will cause it to look puckered when the frame is removed.	p.162
	The column stitches are too long.	Re-digitize the pattern with fill stitching or with multiple rows of column stitching.	
	The pattern density is too heavy.	Too many stitches in an area pull fabric, causing it to pucker.	
	There is a mistake in the upper or bobbin threading.	Check the steps for threading the machine and rethread it correctly.	p. 48
	Spool cap is set incorrectly.	Check the method for attaching the spool cap, then reattach the spool cap.	p. 49
The upper thread is too tight.	The bobbin thread is incorrectly installed.	Correctly install the bobbin thread.	p. 33
Bobbin thread does not wind neatly on the bobbin.	The thread is not passed through the bobbin winding thread guide correctly.	Correctly pass the thread through the bobbin winding thread guide.	p. 34
	Bobbin spins slowly.	Press [+] in the bobbin winding window to increase the bobbin winding speed.	p. 36
	The thread that was pulled out was not wound onto the bobbin correctly.	Wind the thread that was pulled off around the bobbin 5 or 6 times clockwise.	p. 34



Symptom	Probable Cause	Remedy	Reference Page
Nothing happens, even if the LCD display is pressed.	The screen has been locked.	Touch  to unlock the screen.	p. 54
The LCD screen is fogged up.	Condensation has formed on the LCD screen.	After a while, the cloudiness will disappear.	
LED pointer does not indicate the position correctly.	With thick or elastic fabric, the position will be misaligned only at raised parts in the fabric.	Manually adjust the position according to the thickness of the fabric.	p. 83
	With fabric having a very uneven surface, the position is not correctly aligned.	The pointer indication should be used only as a reference.	

CAUTION

- This machine is equipped with a thread detecting mechanism. If the machine is not threaded with the upper thread, the machine will not operate correctly, even if the “Start/Stop” button is pressed after unlocking the machine.
- If the machine suddenly stops:
 - Turn off the machine, and unplug the power cord.
 - Restart the machine with the correct operating procedure. Refer to page 28.

Error messages

If the "Start/Stop" button is pressed while the machine is not correctly set up or if an incorrect operation is performed, the machine stops and informs you of the error with a buzzer and an error message. If an error message appears, correct the problem according to the instructions in the message.

To close the message, touch  or perform the correct operation, then touch . If the message appears again, consult your nearest authorized Brother dealer.

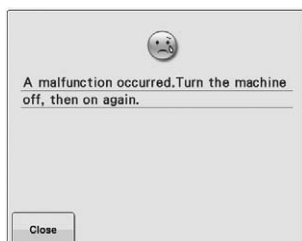

Some malfunction occurred.

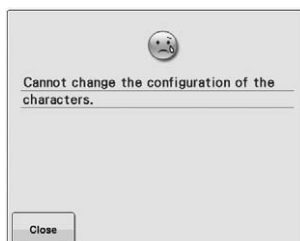

There are too many characters in the curved text arrangement for the selected embroidery frame.
Change the text arrangement or the embroidery frame.



The pattern data that you tried to recall is invalid.
Check the pattern data.

- The pattern data is damaged.
- You tried to recall data created using another manufacturer's data design system. (Refer to page 104.)

Turn the machine off, then on again to return it to its normal condition.

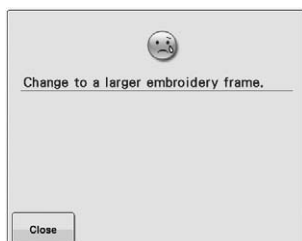

The installed embroidery frame is too small.
Check which embroidery frames can be used, and then install a larger embroidery frame. (Refer to page 42.)

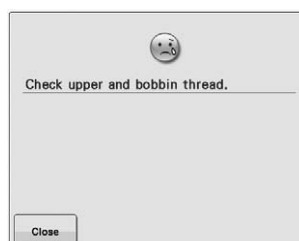

The upper thread broke, the thread came out of the thread tension disc or a thread guide, or the machine is not threaded correctly.
Check that the thread passes under the upper and middle thread guides, and correctly thread the upper thread. (Refer to page 48.) If the thread is not broken, clean the thread guides and the tension unit. (Refer to page 166.)

The bobbin thread broke or ran out.
Check that there is thread on the bobbin and that approximately 50 mm (2 inches) of thread has been pulled out, and then re-install the bobbin. (Refer to page 33.)



The patterns you are editing take up too much memory, or you are editing too many patterns for the memory.

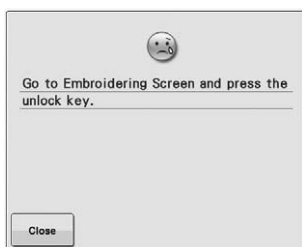

You can start embroidering only when you go to the embroidering screen, and then touch  key.



The automatic threading mechanism did not operate correctly. Remove the thread entangled in the automatic threading mechanism, and then touch .



Another operation was performed while the automatic threading mechanism was threading the needle. Press the "Automatic Threading" button, and then perform the other operation after the needle is threaded. (Refer to page 51.)



Too many patterns are being combined for the amount of memory available. Delete some patterns from the combined pattern.

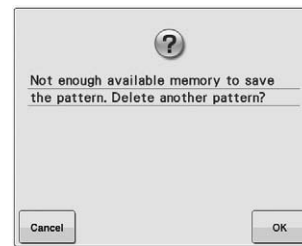

The pattern could not be saved because the memory is full. Delete some patterns.



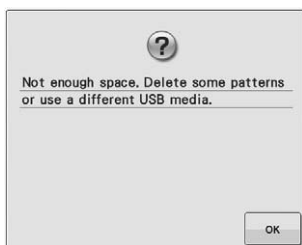

This message is displayed when the memory is full and the stitch or pattern cannot be saved.



The memory capacity of the USB media has been exceeded. There is too much data in either the machine or the USB media.



 was touched in the embroidering screen. Touch  to return to the embroidering settings screen. The previous embroidery in the embroidering screen will be canceled.

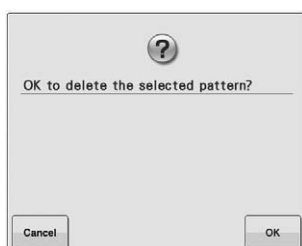

The selected pattern is going to be deleted because  was touched.

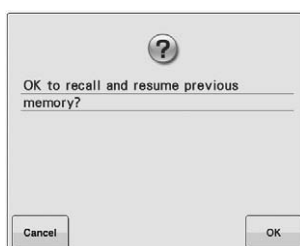

The machine was turned off while sewing, then turned on again. Touch  to return the machine to the condition (pattern position and number of stitches) when it was turned off. Follow the procedure described in "Resume Embroidering After Turning Off the Machine" on page 89 to align the needle position and sew the remainder of the pattern.



 was touched while thread colors were being changed.

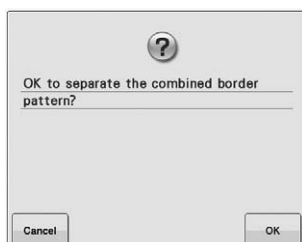

A saved combined pattern is being rotated in the embroidering settings screen.

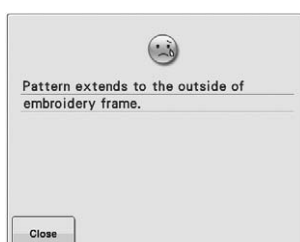

This message is displayed when the character pattern combination is too large to fit in the embroidery frame.

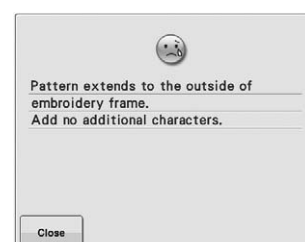

This message is displayed when the character pattern combination is too large to fit in the embroidery frame. Change the character pattern size or layout the patterns to fit the embroidery frame.

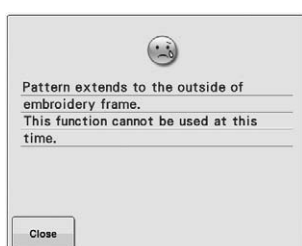

This message appears when the embroidery character pattern is resized so that it is too large for the embroidery frame.

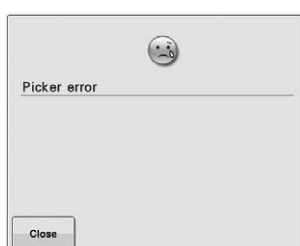

The thread picker did not operate correctly. Remove the thread entangled on the thread picker.



The thread trimming button was pressed before the machine was unlocked.

Touch  to use the thread trimming function.



The motor has locked up due to tangled thread or for other reasons related to thread delivery.
If the thread is entangled in the bobbin case, clean the race, and then oil it.
(Refer to page 166 and 169.)



The USB media is write-protected. Cancel the write protection.



The USB media is write-protected. Touch , and cancel the write protection.

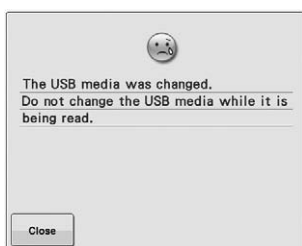

You tried to select a pattern after the USB media in which the pattern is saved has been changed.

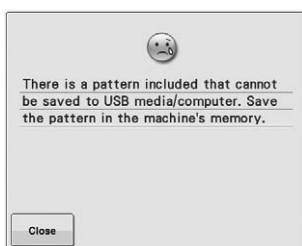

You tried to save a copyright-protected pattern to USB media or a computer. According to copyright laws, patterns that are illegal to reproduce or edit cannot be saved to USB media or a computer. Save the pattern in the machine's memory.



You tried to use an editing function while the pattern is not completely within the red outline. Move the pattern so it is completely within the outline.



An unusable embroidery card is inserted. Remove the embroidery card.

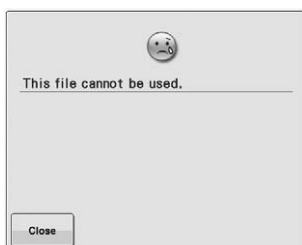

The file format is incompatible with this machine. Check the list of compatible file formats. (Refer to page 67.)

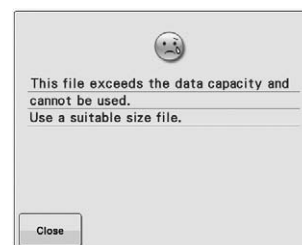

The file size exceeds the data capacity of the machine. Confirm the file size and format. (Refer to page 113, 114.)

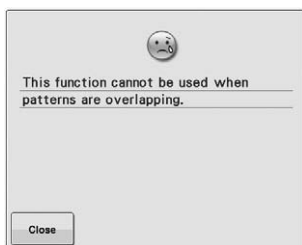

The thread color sorting function cannot be used for the overlapped patterns. Edit the pattern to solve the overlapping issue.



This message is displayed when the selected stitch is not available for the specific function.



The pattern has too many stitches and cannot be used. Data with stitches that exceed specifications (500,000 stitches) cannot be displayed. Use data design software to reduce the number of stitches.

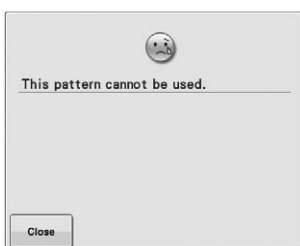

This message appears when you try to retrieve a pattern that cannot be used with this machine.

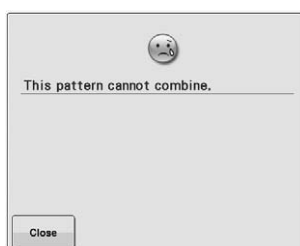

A large-size (split) embroidery pattern was selected to be combined with another embroidery pattern. This pattern can not be combined.



You tried to use incompatible media.



This message is displayed when you try to use incompatible USB media. For a list of compatible USB media, visit "<http://support.brother.com>".

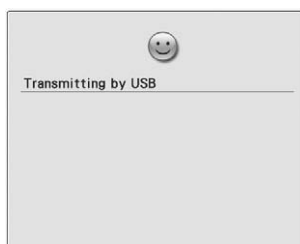

The USB media is transmitting.



Dust may have accumulated within the moving cutter. Clean the moving cutter. (Refer to page 165.)



You tried to recall or save a pattern while no USB media is loaded. Load USB media.

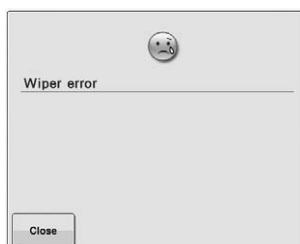

An error has occurred with the upper threading. Consult your nearest authorized Brother dealer.



The machine needs maintenance. (Refer to page 169.)

If the machine does not respond when a key is pressed

If nothing happens when a key on the screen is touched (no key can be selected or the keys are misaligned), adjust the touch panel as described below.

- 1 Touch anywhere inside the touch panel, and turn the machine off, then on again.

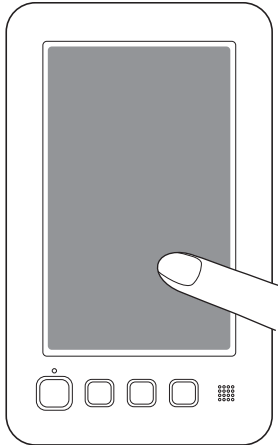

- Continue touching the touch panel until the screen shown below appears.
 - The “Start/Stop” button is red.
- The adjustments screen appears.

- 2 Use the included touch pen to touch the center of the numbered crosses on the screen, from 1 to 5.

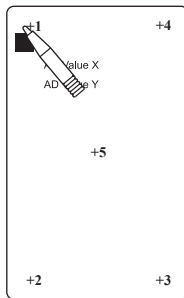

- AD Value X and AD Value Y numbers change with the touch of each numbered cross to show variables.
- If the buzzer sounds when cross number 5 is touched, an error occurred during setting, and “ERROR” appears on the screen. Touch the crosses again, starting from 1 to 5.

⚠ CAUTION

- Be sure to use the included touch pen to adjust the touch panel. Do not use a mechanical pencil, screwdriver or any other hard or sharp object. Do not apply pressure to the LCD screen display, otherwise damage to the display may result.

- 3 After making the necessary touch panel adjustment, “SUCCESS” will show on the screen.



Note

- If the keys still do not respond, even after the touch panel is adjusted, or if the touch panel cannot be adjusted, contact your nearest authorized Brother dealer.

- 4 Turn the machine off, and on again.

Specifications

Embroidery machine specifications

Item	Specification
Weight	31 kg (68 lb)
Machine size	511 (W) × 587 (D) × 747 (H) mm (20-15/128 (W) × 23-7/64 (D) × 29-13/32 (H) inches)
Embroidering speed	Speed range / Max.: 1,000 spm, Min.: 400 spm
Hook Type	Vertical rotary hook
Hook size	Normal size (Type L)
Needle	HA130EBBR / #11
Thread tension	Manual
Thread trimming	Upper and lower thread
Thread breakage sensor	Yes / Upper thread and bobbin thread
Automatic needle threader	Yes
Communication with PC	USB port
Data storage	USB media

* Please be aware that some specifications may change without notice.

Upgrading Your Machine's Software

You can use USB media or a computer to download upgrade software for your embroidering machine. When an upgrade program is available on " <http://support.brother.com> ", please download the files following the instructions on the website and steps below.



Note

- When using USB media to upgrade the software, check that no data other than the upgrade file is saved on the USB media being used for this upgrade.
- Compatible operating systems:
Microsoft Windows XP, Windows Vista, Windows 7, Windows 8

Upgrade procedure using USB media

- 1** While pressing the automatic threading button, turn the main power to on.

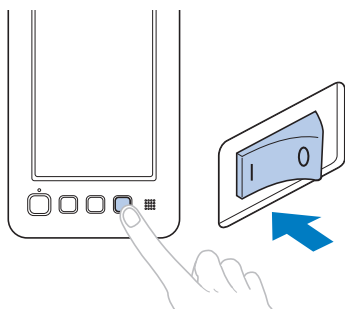

→ The following screen will appear on the LCD.

- 2** Touch  .

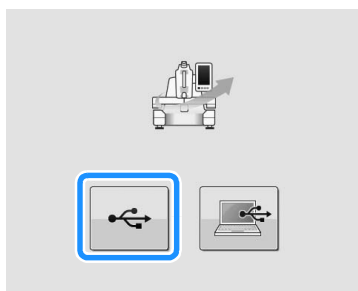

- 3** Insert the USB media into the USB port on the machine. The media device should only contain the upgrade file.

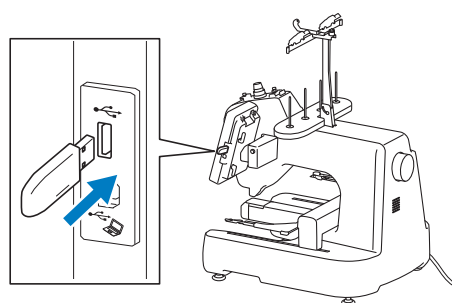

- ① USB port
② USB media



Note

- The access lamp will begin blinking after inserting USB media, and it will take about 5 to 6 seconds to recognize the media. (Time will differ depending on the USB media).

- 4** Touch  .



→ The upgrade file is loaded.



Note

- If an error occurs, a red text error message will appear. When the load is performed successfully, following message will appear.



- 5 Remove the USB media, and turn the machine off and on again.

Upgrade procedure using computer

For computers and operating systems, see “Precautions on using the computer to create and save data” on page 105.



Note

- Do not connect any additional USB media devices to your computer when using the USB cable.

- 1 While pressing the automatic threading button, turn the main power to on.

→ The following screen will appear on the LCD.

- 2 Touch .

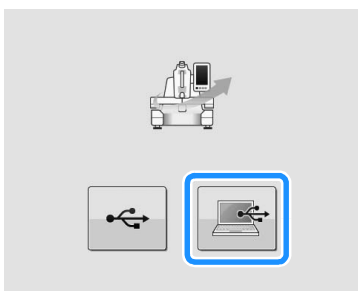

- 3 Plug the USB cable connector into the corresponding USB ports for the computer and for the machine.

→ “Removable Disk” will appear in “Computer (My computer)”.

- 4

Copy the upgrade file to “Removable Disk”.

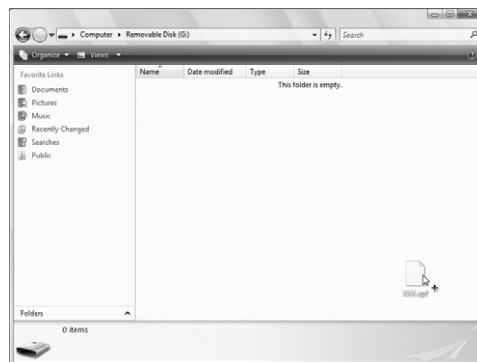

- 5

Touch .

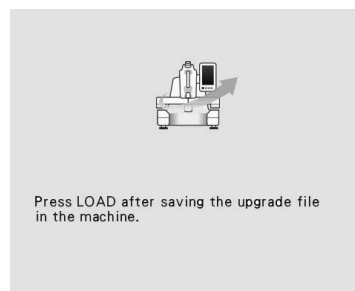

→ The upgrade file is loaded.



Note

- If an error occurs, a red text error message will appear. When the load is performed successfully, following message will appear.



- 6

Unplug the USB cable, and turn the machine off and on again.



Index

A

Accessories	16
Add key	63, 119
Adjusting	
angle	83
edited patterns	121
legs	20
sewing speed	99
thread tension	91
touch panel	182
Alphabet patterns	108
Appliqué sewing	154
Array key	64, 111, 124
Arrow key	65, 83, 121
Automatic thread cutting function	101
“Automatic Threading” button	15, 51
Automatic threading mechanism	51

B

Background colors	146
Backing	161
Basic operation	150
Basic procedures	27
Basting	96
Bobbin	26
installing	33
winding	34
Bobbin case	32, 33, 91, 166
reinstalling	33
removing	32
Border key	64, 128
Brightness	149

C

Canton fleece	163
Canvas	163
Change thread color key	64, 127
Changing	
character spacing	124
colors of the pattern	127
display guides	144
embroidering position	83
embroidery basting distance	146
language	148
size	122
text alignment	111
text arrangement of a character	124
thread color display	145
thread density	126
units of measurements	146
Checking	
preview image	41
thread tension	57
Cleaning	
around the needle plate	165
bobbin case	166
hook	164
LCD	164
machine surface	164
maintenance message	169
thread paths	166
Color thread table	159
Combining patterns	119
Computer	
connecting	104

port	69
Corduroy	163
Cotton sheeting	163

D

Decorative alphabet patterns	107
Delete key	63, 109, 136
Deleting	
pattern	136
Denim	163
Density key	64, 126
Display	26
Display guides	144
Distance from center (horizontal)	63
Distance from center (vertical)	63
Dress shirt (woven)	163
Duplicate key	64, 136
Duplicating a pattern	136

E

Eco mode	148
Editing	39, 119, 137
combined pattern	138
Embroidering	
corner of fabric	80
restart from beginning or middle	87
small fabric	80
tape or ribbon	80
Embroidering position	83
Embroidering screen	40, 65, 137
Embroidering settings screen	40, 137
Embroidering speed	99
Embroidering time	65
Embroidery basting key	65
Embroidery cards	112
Embroidery data	104
Embroidery frame	
attaching to the machine	44
hooping	42
removing	58
Embroidery frame holder	
attaching	21, 22
Embroidery frame indicators	42, 63
Embroidery positioning marker	40
Embroidery thread	48
Error messages	177

F

Fabric	26, 80
recommendations	26
removing	58
Fabric/stabilizer compatibility chart	163
Features	7
Flipping a pattern	121
Forward/Backward stitch key	66, 85, 87
Frame patterns	107
Front view	14

G

Golf shirt	163
------------------	-----

H

Handwheel	168
Headwear	163
Hook	164
Hooping	42, 77, 162
Horizontal mirror image key	62, 64, 121

I

Included accessories	16
----------------------------	----

J

Jump stitch	101
-------------------	-----

L

Language	29, 148
LCD	15, 26, 60
LED pointer	40, 149
Light	149
Lingerie	163
Locking mechanism	54

M

Machine operations guide key	150
Magnify key	63, 120
Main power switch	28, 59
Maintenance	150, 164
Maximum embroidering speed key	66, 99
Memory key	66, 113, 114
Moving a pattern	121
Multi color key	64, 126

N

Names of machine parts	14
Needle	25
changing	72
threading	51
Needle plate	165
Next page key	62, 106
Number of thread color changes	65

O

Oiling	168
Opening screen	148
Operation panel	15
Optional accessories	17

P

Pattern display area	62
Pattern editing screen	39, 63, 119
Pattern list screen	37, 62
Pattern selection	106
Pattern selection key	63, 120
Pattern size	62, 63
Pattern type selection screen	37, 61
Positioning key	63, 65, 83, 121
Power supply cord	28, 59
Preview key	62, 63, 65
Previewing the Image	41
Previous page key	62, 106
Principal parts	14, 150

R

Region display	65
Resume embroidering	89
Retrieving	

from computer	117
from Embroidery cards	112
from the machine's memory	115
from USB media	116
Return key	62, 66
Right-side/rear view	15
Rotate all key	65, 83, 137
Rotate key	64, 123
Rotation angle	63

S

Satin jacket	163
Saving	
to computer	114
to the machine's memory	113
to USB media	114
Screen	26, 30, 31, 60
Selecting	
edited pattern	120
embroidery pattern	37, 106
Set key	62
Setting up	18
Settings key	142
Sewing the embroidery	54
Shutoff support mode	148
Silk	163
Size (horizontal)	63
Size (vertical)	63
Size key	62, 64, 122
Spacing key	64, 124
Speaker	15
speaker volume	147
Specifications	183
Stabilizer	76, 161, 163
"Start/Stop" button	15, 54
Starting position key	66, 97
Stitch count	65
Stopping embroidering	55
Sweater knit	163
Sweatshirt	163

T

Tajima data	159
Terry cloth	163
Thread	26, 48, 160
Thread color	159
Thread color display	145
Thread color sequence display	65
Thread color sorting	65, 100
Thread density	126
Thread guide assembly	21
Thread information (color/time)	47, 65
Thread recommendations	26
Thread sensor	147
Thread spools	
easily changing	53
Thread tension	91
Thread tension knob	57, 92
Thread trimming button	15, 55
Thread trimming function	101
Thread trimming/cutting	66, 101
Threading	
needle	51
upper thread	47, 48
Thumbnail size	147
Tips for machine operation	159
Touch panel	15
Trial sewing key	46, 66
Troubleshooting	150, 170
T-shirt	163

U

Uninterrupted embroidering (one color)	65, 100
Units of measurements	146
Unlock key	54, 66
Upgrading machine's software	184
computer	185
USB media	184
Upper thread guide pretension knob	57, 92
Upper threading	47
USB connectivity	68
computer	69
embroidery card Reader/USB card writer module	68
USB media	68

V

Version	143
---------------	-----

W

Winding the bobbin	34
Wiper	52



Please visit us at <http://support.brother.com/> where you can get product support and answers to frequently asked questions (FAQs).

English
882-T51
Printed in Taiwan



XG1496-001①