

ASSEMBLY INSTRUCTIONS

EEI-6545

V1.06.02.21

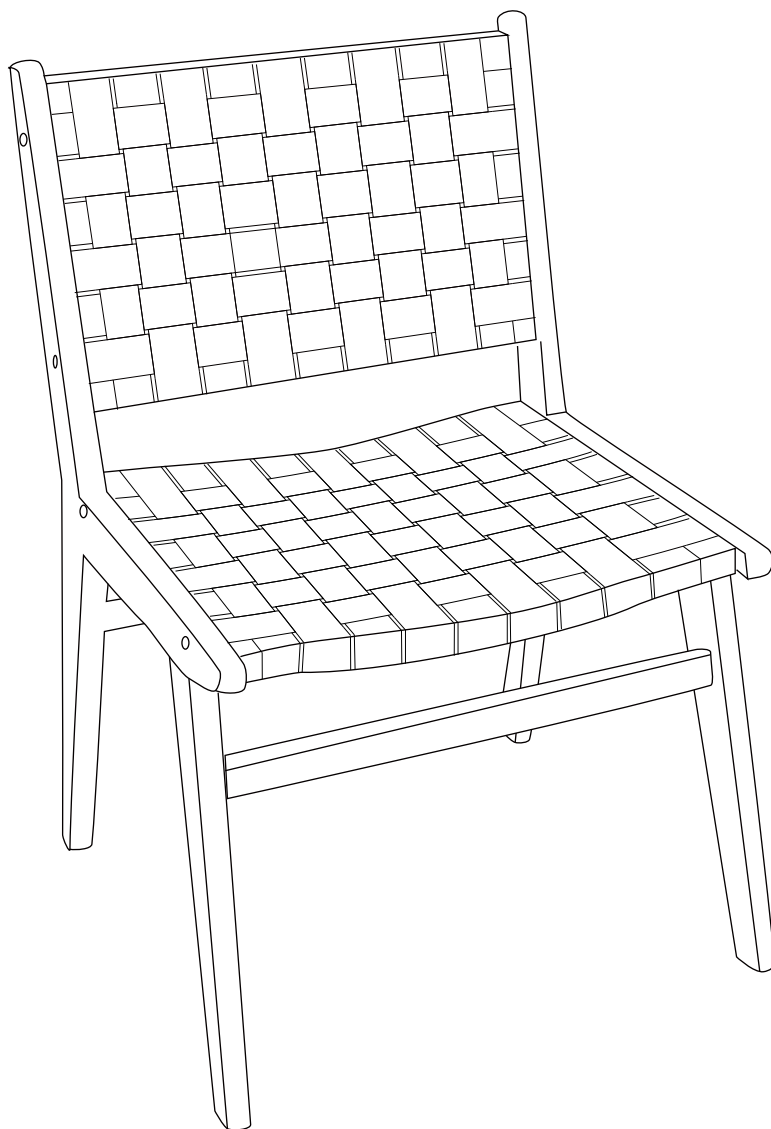

Questions? Contact us!

609.256.9000 • cs@modway.com
www.modway.com

*modway

Let's get started!

*modway



Read through all of the instructions before starting



Care instructions are listed in the last step of this manual



Approx. 30 minutes assembly time



Make sure you have all parts and components before discarding any packing materials



2 people recommended for assembly

Only use hand tools to assemble this item. Do not use power tools. Do not tighten bolts or screws completely until all hardware is lined up and inserted into the holes.

Do not over-tighten screws and bolts to avoid stripping the hardware or cracking the item.







Assemble your item on a flat, carpeted area, with plenty of space to work. This will prevent damage and scratches to your floors or the item while you're assembling the product.

Keep all components and packaging out of reach of children or animals to avoid risk of choking or suffocation.

Furniture components:

| | | |
|---|------------|----|
| 1 | Backrest | x1 |
| 2 | Seat Plate | x1 |
| 3 | Left Leg | x1 |
| 4 | Right Leg | x1 |
| 5 | Stretcher | x2 |

Provided hardware:

| | | | |
|---|-------------------------------------------------------------------------------------|--------------------|----|
| A |  | Cam Bolt M6 x 45mm | x8 |
| B |  | Spring Washer | x8 |
| C |  | Flat Washer | x8 |
| D |  | Allen Key | x1 |
| E |  | Screw #40mm | x4 |
| F |  | Bung | x8 |

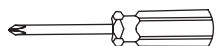
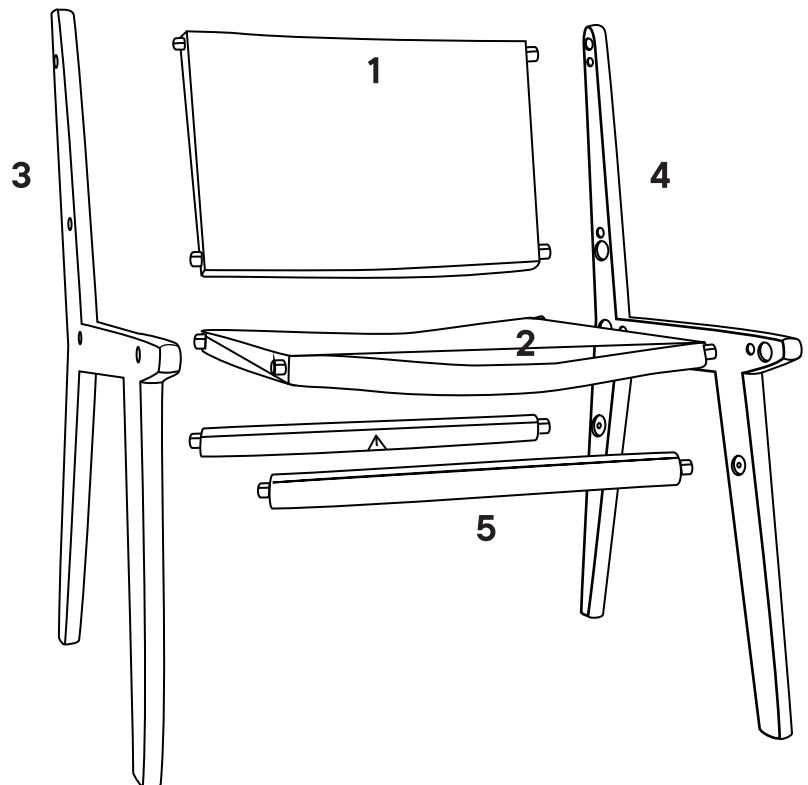

PHILLIPHS HEAD
SCREW DRIVER
NOT PROVIDED

Wait!

Missing parts or hardware? Need assistance?

Contact us before returning your item. We're here to help!

609.256.9000 • cs@modway.com

Step 1

COMPONENTS

- 1 Backrest x1
- 2 Seat Plate x2
- 3 Left Leg x2
- 4 Right Leg x2
- 5 Stretcher x2

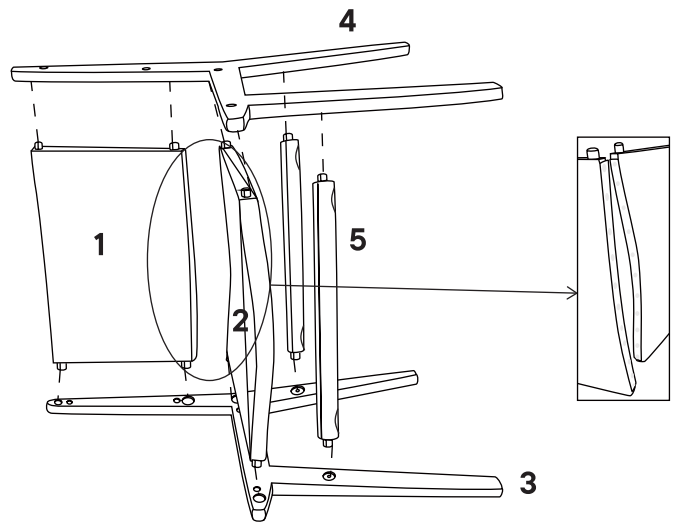

Step 2

HARDWARE

- A Connecting Bolt M6 x 45mm x8
- B Spring Washer x8
- C Flat Washer x8

TOOLS

- D Allen Key x1

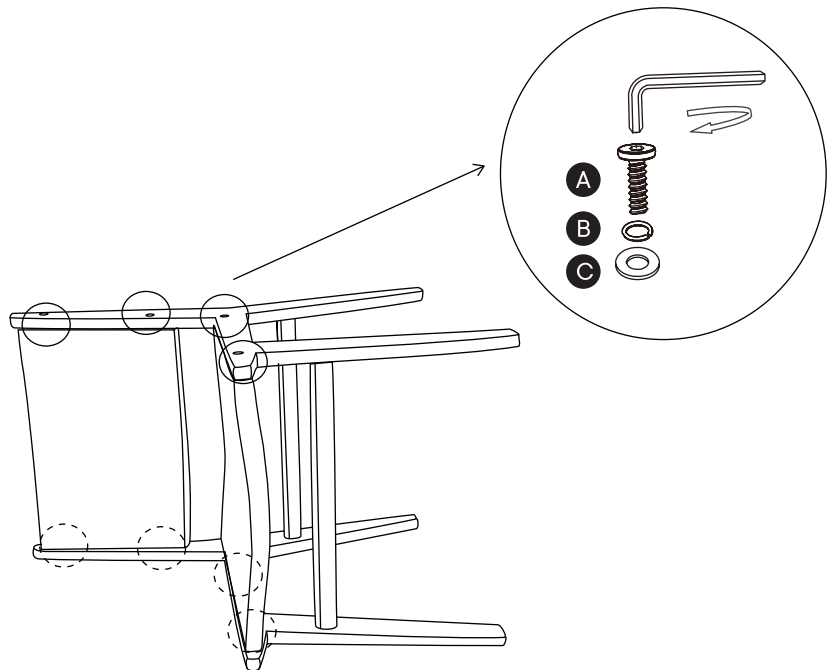

Step 3

HARDWARE

- E Screw #40mm x4

TOOLS

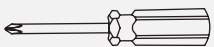

PHILLIPS HEAD
SCREW DRIVER
NOT PROVIDED

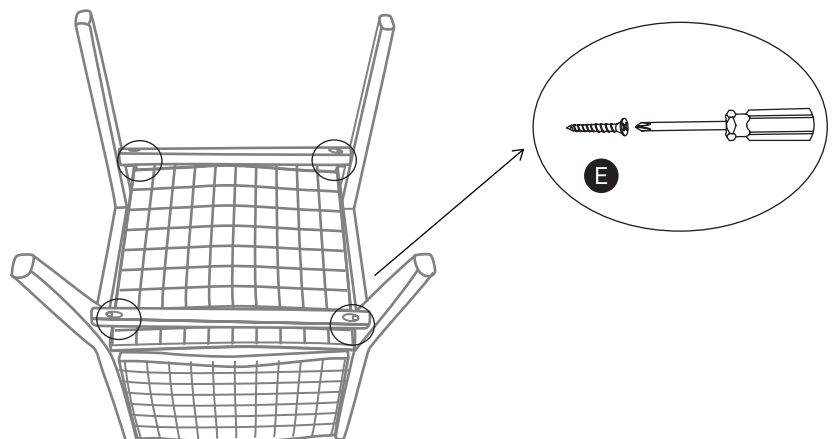

Step 4

HARDWARE

F Bung x8

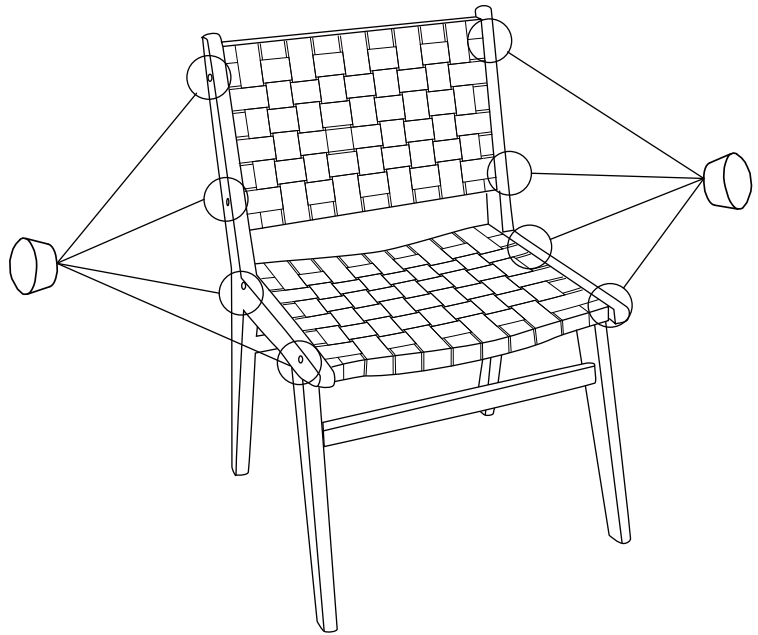

Great job!

Your new chair stool is complete.

♥ CARING FOR YOUR ITEM

Depending on use, it may be necessary to tighten the hardware from time to time, so please save the tools that have been provided.

Not contract grade.

Clean using a non-abrasive cloth and a mild cleaner.

Retain the rich wood color by occasionally sanding lightly and applying a teak cleaner and protectant. The oils nourish and help restore the original look.

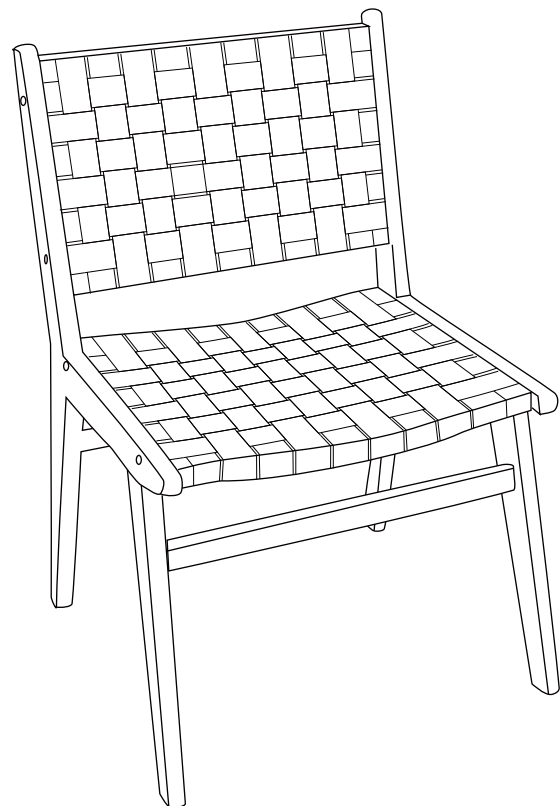

CONNECT WITH US!   

Tag us @modway_furniture and #modway for a chance to be featured.