

# SANTÉ

table | user guide



  
UMAGE

A black, minimalist lamp stand with a wide, flat base sits on a round wooden table. A white charging cable is plugged into the bottom of the stand and connected to a gold smartphone lying on the table. The background is a plain, light-colored wall.

**USB**

The stand has a hidden, integral USB-port so you can charge your phone or tablet, even when the light is turned off.

## WITH LOVE FROM COPENHAGEN

At UIMAGE, our designers take inspiration from the distinct nature of the Nordic landscape to create unique designs related to the way we live in an urban setting. Influenced by the design language, colours and materials found around us in Scandinavia, we create a collection that is rooted in our home but designed for everyone.

Versatile, flexible and multifunctional, our designs are created to enhance an urban lifestyle in smaller spaces!



## **ENGLISH**

If the external flexible cable or cord of this luminaire is damaged, it shall be exclusively replaced by the manufacturer or his service agent or a similar qualified person in order to avoid a hazard.

## **FRANÇAIS**

Si le câble électrique de ce luminaire est endommagé, il peut être remplacé. Pour éviter tout danger, le remplacement doit impérativement être effectué par le fabricant, un représentant de celui-ci ou un réparateur agréé.

## **ESPAÑOL**

Si se dañase el cable exterior flexible de esta lámpara, para evitar riesgos deberá ser sustituido exclusivamente por el fabricante, su representante o un electricista cualificado.

# **! IMPORTANT !**

## **Light stand safety instructions**

**(Read and keep these instructions for future reference)**

**Rating parameter: 120V, 60 Hz, AC ONLY**

**Lamp type: E26 Type A / 60W MAX**

### **NOTE**

**This instruction sheet covers a variety of stands (different colors), but with the same applications. Do not connect your stand to a power source until all stand- and lamp assembly and bulb installation is complete.**

### **NOTICE**

**You are advised to contact a qualified electrician for these procedures**

## **IMPORTANT SAFETY INSTRUCTIONS**

**This portable lamp has a polarized plug (one blade is wider than the other) as a feature to reduce the risk of electric shock. This plug will fit in a polarized outlet only one way. If the plug does not fit fully in the outlet, reverse the plug. If it still does not fit, contact a qualified electrician. Never use with an extension cord unless plug can be fully inserted. DO NOT ALTER PLUG.**

## **SAFETY PROCEDURES**

**Read and keep these instructions for future reference**

- 1. Remove the packaging carefully without the use of sharp objects. Assemble the product as shown in this user guide, then place the product firmly on a fixed surface before moving onto next procedure.**
- 2. Unscrew the ring of the socket. Assemble the suitable lampshade (not included) and put it on the socket and screw the ring back on until lampshade is completely fastened.**
- 3. Firmly screw an E26 light bulb (MAX 60W) into the socket. Do NOT put your fingers into the socket!**



- 4. Insert the plug into a suitable outlet and turn on the power supply.**
- 5. Switch to on.**
- 6. Always disconnect the power-supply before cleaning, changing of light bulbs or repair of the stand. The latter, should always be done by a qualified electrician.**
- 7. Let the light bulb cool off sufficiently before changing the bulb.**
- 8. Keep the stand away from any flammables, or objects that cannot handle heat.**
- 9. Please always place the stand on a level surface not more than 8° angle.**
- 10. The stand is for indoor use ONLY.**

- 11. If the stand in any way malfunctions, to avoid accidents or mishandling of the stand, please always contact a qualified electrician.**
- 12. Only use the stand, where these same official electrical- and technical parameters exist!**
- 13. Do NOT touch the light bulb immediately after the light is turned off. Be aware of possible scalding!**
- 14. The stand is NOT a childrens toy and should not be used in any other manner than described above.**
- 15. The minimum diameter of open area (top & bottom) should NOT be less than 100MM (4 inches); Lamp-to-shade spacing must be over 3-1/4 inches (63.5mm); Lamp Centerline Length must over 2-1/2 inches (82.5mm).**

- 16. The weight of lamp shade should NOT exceed 1.1 KGS (2-1/2LBS).**

### **NOTE**

**DO NOT try to repair the product if the cable, socket or the lampshade is in any way broken or not as expected, such tasks are only intended for qualified electricians!**

## **! IMPORTANT !**

**Consignes de sécurité du support d'éclairage  
(Lisez et conservez ces instructions pour  
référence future)**

**Paramètre d'évaluation: 120 V, 60 Hz, CA UNIQUEMENT  
Type de lampe: E26 Type A / 60W MAX**

### **REMARQUE**

**Cette fiche d'instructions couvre une gamme de supports de différentes couleurs, mais ayant les mêmes applications. Ne connectez pas votre support à une source d'alimentation tant que l'ensemble du support et de la lampe et de l'installation de l'ampoule n'est pas terminé.**

### **REMARQUE**

**Il est conseillé de contacter un électricien qualifié pour ces procédures**

## **INSTRUCTIONS IMPORTANTES DE SÉCURITÉ**

**Ce luminaire portable a une prise polarisée (une lame est plus large que l'autre) comme une caractéristique pour réduire le risque d'électrocution. Cette prise s'adaptera à une sortie polarrisée d'une manière unique. Si la fiche ne rentre pas complètement dans la prise, inversez la fiche. Si cela ne correspond pas toujours, contactez un électricien qualifié. Ne jamais utiliser avec une rallonge à moins que la fiche ne soit complètement insérée. NE MODIFIEZ PAS LA FICHE.**

# LES PROCÉDURES DE SÉCURITÉ

**Lisez et conservez ces instructions pour référence future**

- 1. Retirez soigneusement l'emballage sans utiliser d'objets pointus. Assemblez le produit comme indiqué dans ce guide d'utilisation, puis placez-le fermement sur une surface fixe avant de passer à la procédure suivante.**
- 2. Dévissez l'anneau de la douille. Assemblez l'abat-jour approprié (non inclus) et placez-le sur la douille et revissez l'anneau jusqu'à ce que l'abat-jour soit complètement fixé.**
- 3. Vissez fermement une ampoule E26 (MAX 60W) dans la douille. Ne mettez PAS vos doigts dans la prise!**

- 4. Insérez la fiche dans une prise appropriée et allumez l'alimentation.**
- 5. Activez.**
- 6. Débranchez toujours l'alimentation avant de nettoyer, de changer les ampoules ou de réparer le support. Cette dernière doit toujours être effectuée par un électricien qualifié.**
- 7. Laissez l'ampoule refroidir suffisamment avant de changer l'ampoule.**
- 8. Gardez le support à l'écart de tout produit inflammable ou objet qui ne peut pas supporter la chaleur.**
- 9. Veuillez toujours à placer le support sur une surface plane ne dépassant pas 8 °.**

- 10. Le support est destiné à une utilisation en intérieur UNIQUEMENT.**
- 11. En cas de dysfonctionnement du support, afin d'éviter des accidents ou une mauvaise manipulation du support, veuillez toujours contacter un électricien qualifié.**
- 12. Utilisez uniquement le support, là où ces mêmes paramètres électriques et techniques officiels existent!**
- 13. Ne touchez PAS l'ampoule immédiatement après avoir éteint la lumière. Attention aux brûlures possibles!**
- 14. Le support n'est PAS un jouet pour enfants et ne doit pas être utilisé d'une autre manière que celle décrite ci-dessus.**



- 15. Le diamètre minimal d'espace ouvert (en haut et en bas) ne doit PAS être inférieur à 100mm (4 pouces). L'espace de la lampe à l'abat-jour doit être supérieur à 63,5mm(3-1/4 pouces). L'axe de la lampe doit être supérieur à 82,5mm (2-1/2 inches).**
- 16. Le poids de l'abat-jour ne doit pas être supérieur à 1,1kg (2-1/2 LBS)**

### **REMARQUE**

**N'ESSAYEZ PAS de réparer le produit si le câble, la prise ou l'abat-jour est en quelque sorte cassé ou pas comme prévu, ces tâches ne sont destinées qu'à des électriciens qualifiés!**



DESIGNED BY  
ANDERS KLEM

“ There is always the  
one that with quiet  
grace and elegance  
draws our eyes,  
without even trying. ”

# ASSEMBLY GUIDE

Ⓐ x 1 pc.

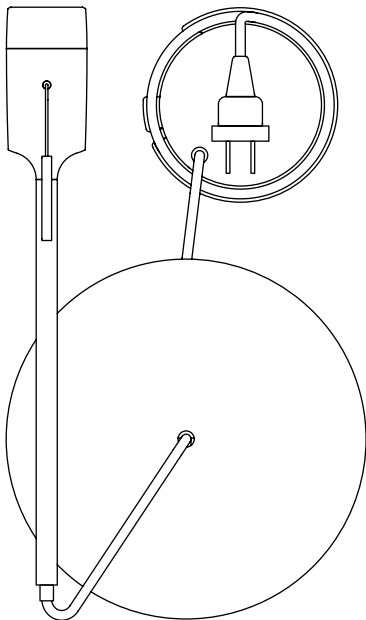

① x 1 pc.

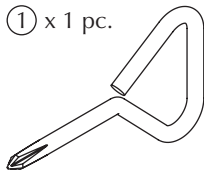

Ⓑ x 5 pcs.



Ⓒ x 1 pc.



Find assembly videos by using the QR code or by going online at our website  
[umage.com/instructions](http://umage.com/instructions)

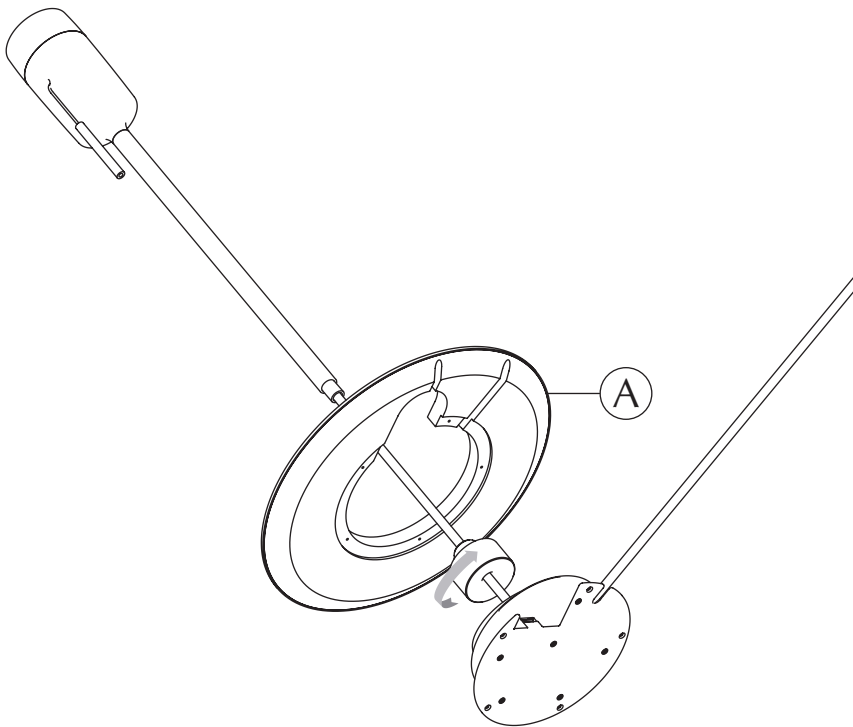

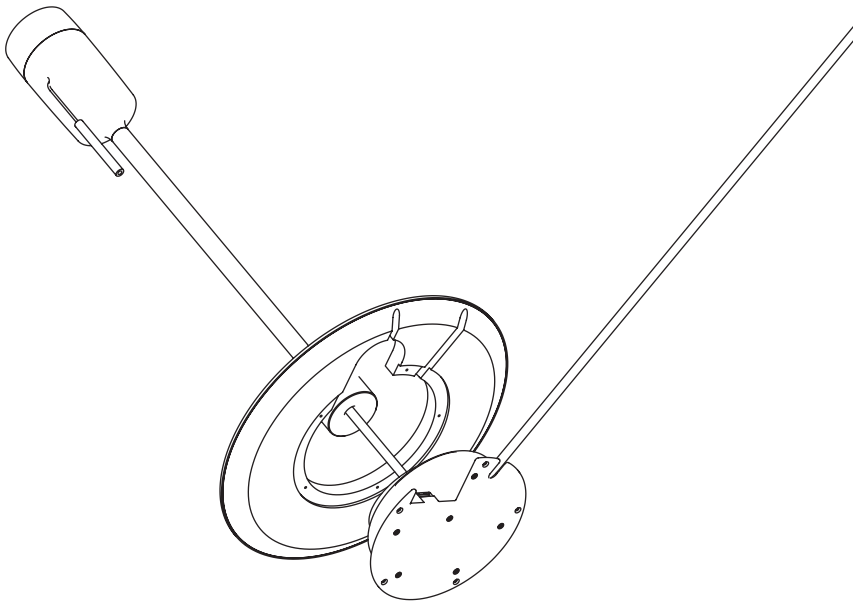

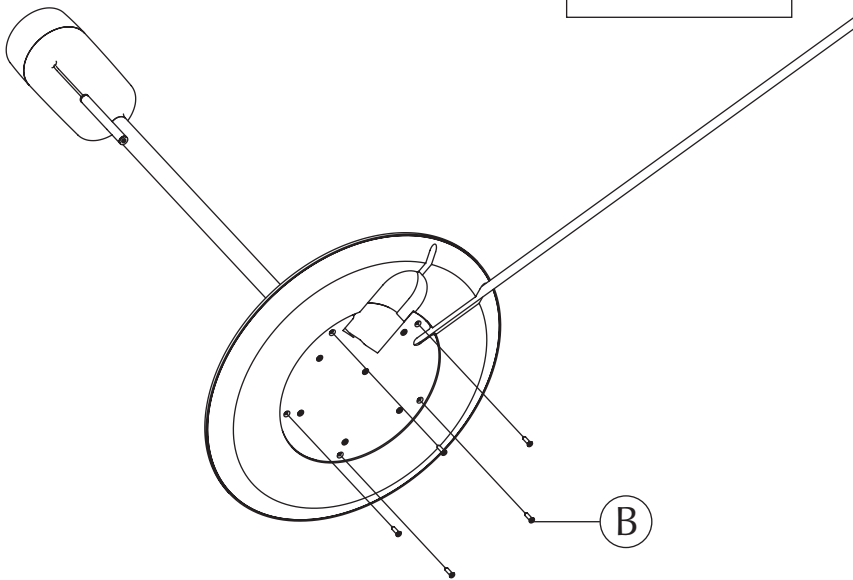
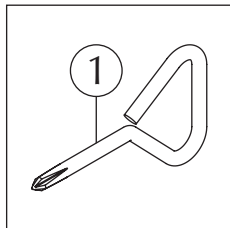

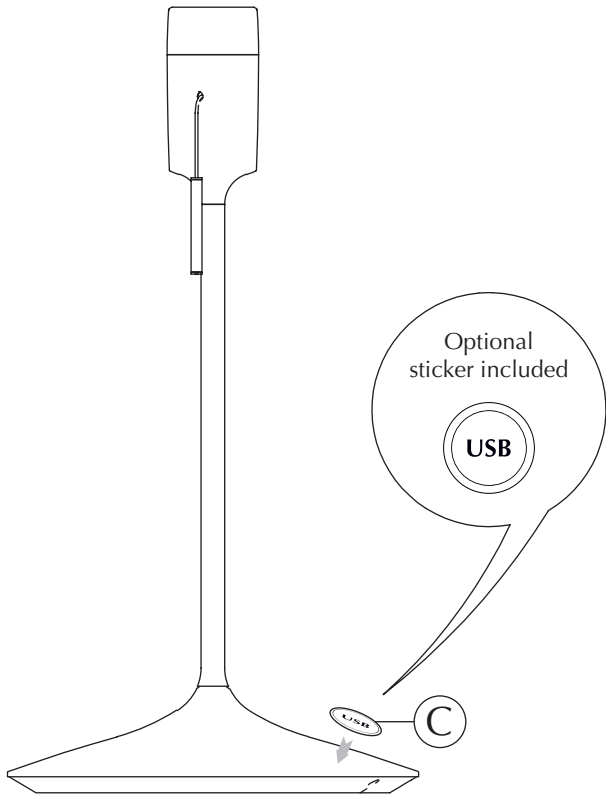



MAX 60W



|— >100 MM / >4" —|

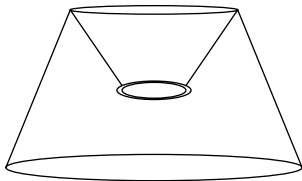

|— >100 MM / >4" —|





EOS mini | light brown  
SANTÉ table | brushed brass  
MY SPOT oak | steel



## SUSTAINABLE SUSTAINABILITY EFFORTS

We are dedicated being sensible frontrunners on the environmental responsibility. If we provide timeless and functional quality designs that last, we know nature will prevail, as will UIMAGE.

*“SAVING THE SCENT OF THE FOREST  
AFTER AN EARLY MORNING RAIN”*



### GIVING BACK TO NATURE

In collaboration with the NGO One Tree Planted, we are planting a tree every time one of our designs made from wood are being sold. Furthermore, we are compensating for the polypropylene products we sell, by donating part of the profits to the NGO Plastic Change, supporting the World ocean clean-up and minimizing plastic pollution.

## MULTIFUNCTION AND FLEXIBILITY

One of the key aspects of the designs at UIMAGE is multiple functions and flexibility. Designing with more than one function in mind is a sustainable mindset as it reduces the number of products you need to buy to get a complete setting for your space.

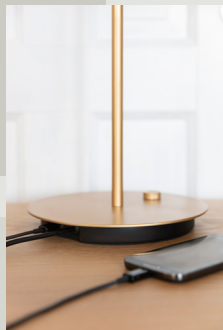

## REUSABLE PACKAGING

To minimize packaging waste, most of the packaging from our lighting collection is repurposed to be used as beautiful storage boxes afterwards. Learn more on the next page...



## REUSABLE PACKAGING

With your new lamp, you have also received a free decorative storage box for the shelf.

### THIS IS HOW IT WORKS

When your new lamp is out of the box you can keep the box and reuse it as a storage box for your small bits and bobs and place it on the shelf or on the top of your closet - repurposing the packaging for you and the environment.



So not only are UIMAGE's designs flat-packed to optimize the global logistics and the environmental footprint, but it ensures that you don't need to throw away tons of packaging material, that can just as well be reused for something new.

Read more about our many sustainability efforts:  
[umage.com/sustainability](http://umage.com/sustainability)



Please follow the marked icons on the packaging materials for correct disposal of the remaining packaging materials:



CARDBOARD



PAPER



Recycle your waste correctly  
by searching for these icons on  
the packaging

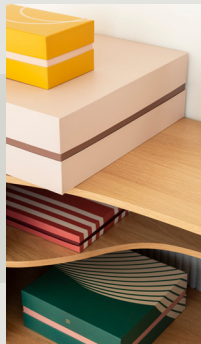

FOLLOW US ON SOCIAL MEDIA



@umagedesign | #umagedesign | umage.com



UMAGE



210622