

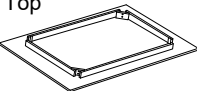

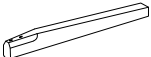

Thank you for purchasing the MODWAY Dining Table!

Before you start, here are some helpful advice:

- 1 . We suggest you spend a short time reading through this leaflet and then follow the simple step-by-step instructions.
- 2 . Owing to the size and weight of the dining table, we recommend that it is assembled by two adults, on a carpeted or padded area, in the room that it is intended for. Approximate assembly time: 60 minutes.
- 3 . Please do not use any tools other than those provided or recommended in these instructions.
- 4 . Please do not throw away any of the packaging or instructions until you have checked all the components and hardware and the furniture is fully assembled.
- 5 . Assemble all components loosely until advised to tighten. Depending on use, it may be necessary to tighten the components from time to time, so please save the tools that have been provided.
- 6 . Please keep all pieces out of reach of small children.

ITEM	Component	QTY
1	Table Top 	1 PC
2	Leg 	4 PCS

ITEM	Hardware	Description	QTY
A	JCBB Bolt M8 x 50mm		8 PCS
B	Spring Washer		8 PCS
C	Flat Washer		8 PCS
D	Allen Key		1 PC

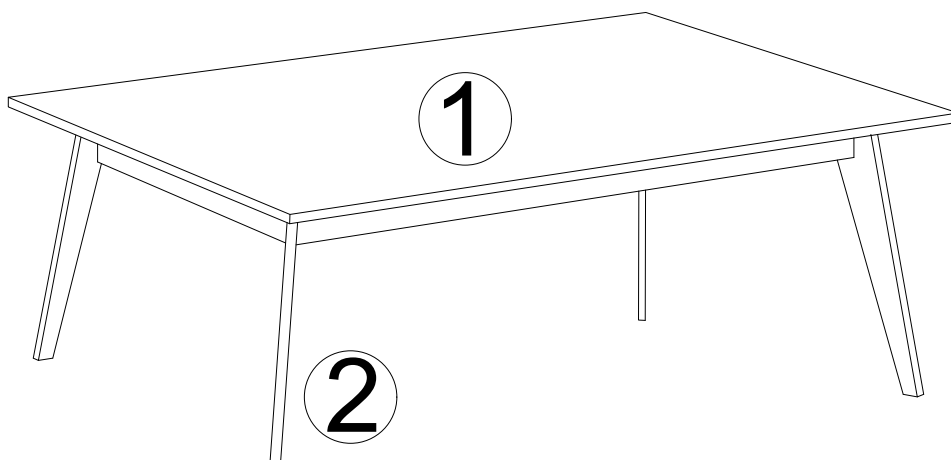

STEP 1:

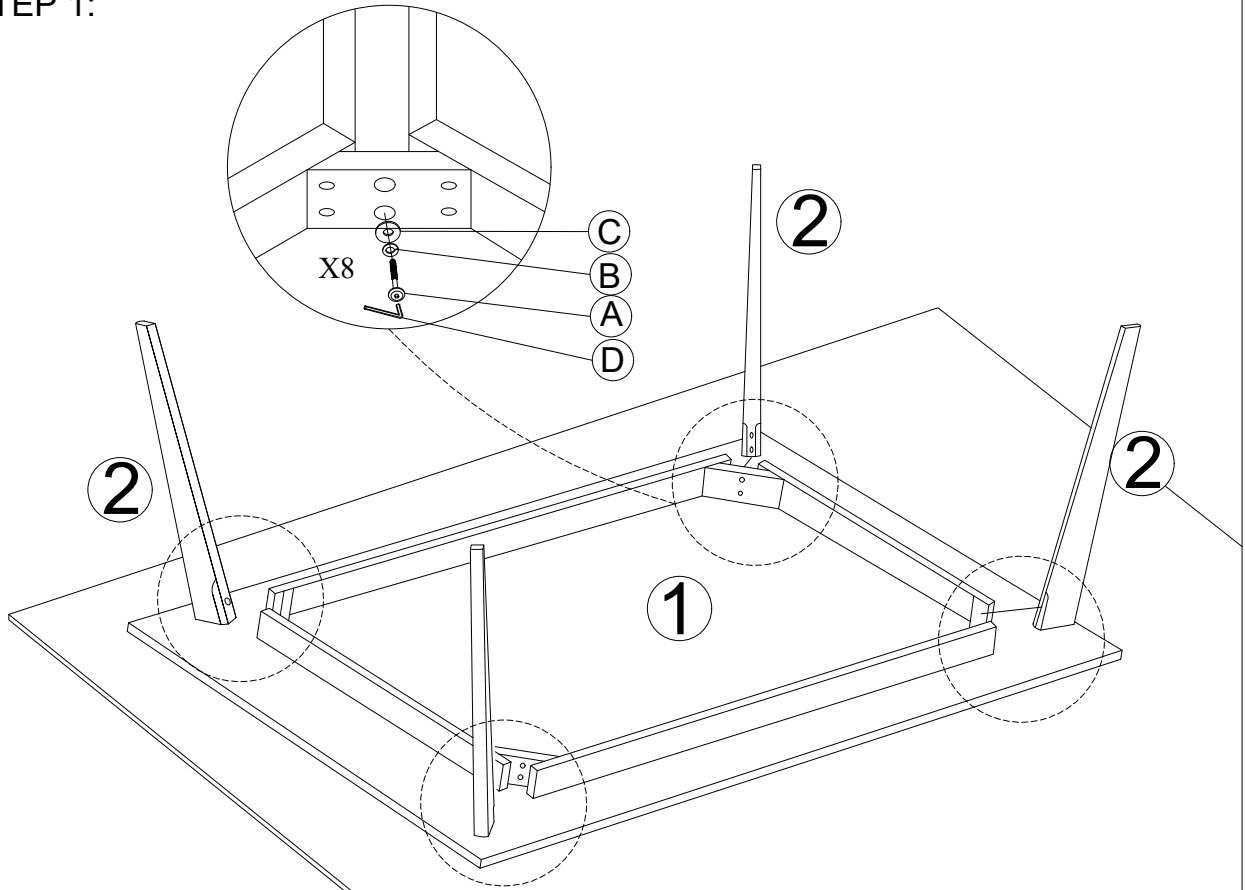

A = 8 pcs	B = 8 pcs	C = 8 pcs	D = 1 pc

Hardware & Tool required

FULLY SET - UP

