

ASSEMBLY INSTRUCTIONS

EEI-6348

V0.02.02.23

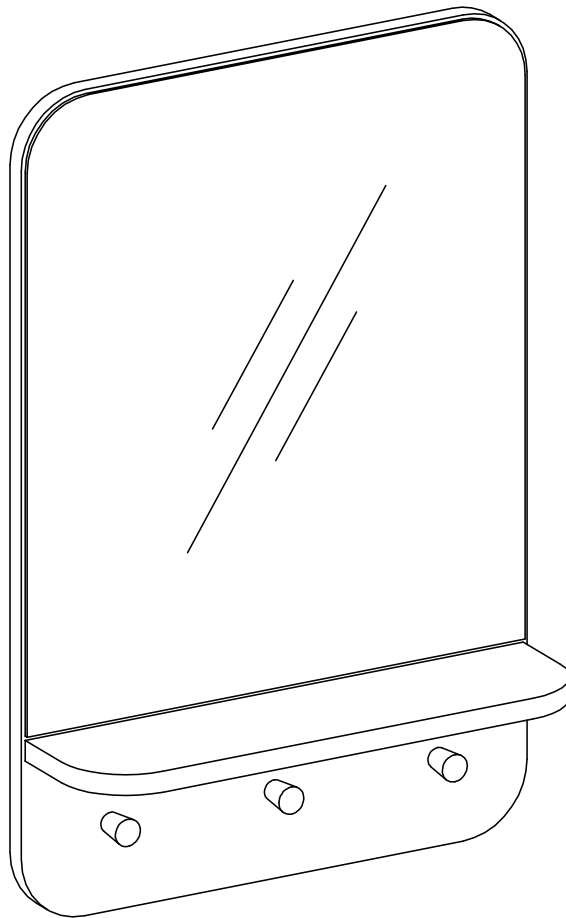

Questions? Contact us!

609.256.9000 • cs@modway.com
www.modway.com

***modway**

Let's get started!

*modway



Read through all of the instructions before starting



Care instructions are listed in the last step of this manual



Approx. 60 minutes assembly time



Make sure you have all parts and components before discarding any packing materials



2 people recommended for assembly

Only use hand tools to assemble this item. Do not use power tools. Do not tighten bolts or screws completely until all hardware is lined up and inserted into the holes.

Do not over-tighten screws and bolts to avoid stripping the hardware or cracking the item.









Assemble your item on a flat, carpeted area, with plenty of space to work. This will prevent damage and scratches to your floors or the item while you're assembling the product.

Keep all components and packaging out of reach of children or animals to avoid risk of choking or suffocation.

Furniture components:

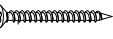
1	Mirror Board	x1
2	Shelf	x1

Provided hardware:

A	 Plastic Dowel Ø8 x 32 mm	x2
B	 Screw M 6.3 x 50 mm	x2
C	 Screw M 6 x 13 mm	x6
D	 Screw M 4 x 25 mm	x3
E	 Screw M 8 x 38 mm	x2
F	 Allen Key	x1
G	 Fisher Ø8 mm	x2
H	 Handle	x3
I	 Hanging Plates	x2

What you need:

 Phillips Head Screwdriver

You may also need:

+ Power Drill
+ Level

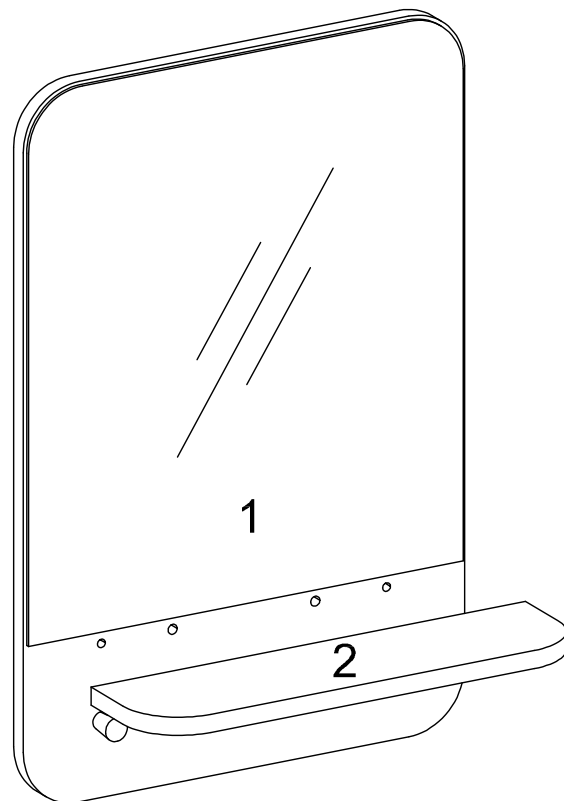

Wait!

Missing parts or hardware? Need assistance?

Contact us before returning your item. We're here to help!

609.256.9000 • cs@modway.com

Step 1

HARDWARE

- A** Plastic Dowel Ø8 x 32 mm x2
- C** Screw M 6 x 13 mm x6
- I** Hanging Plates x2

COMPONENTS

- 1** Mirror Board x1
- 2** Shelf x1

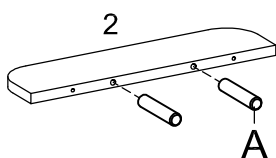
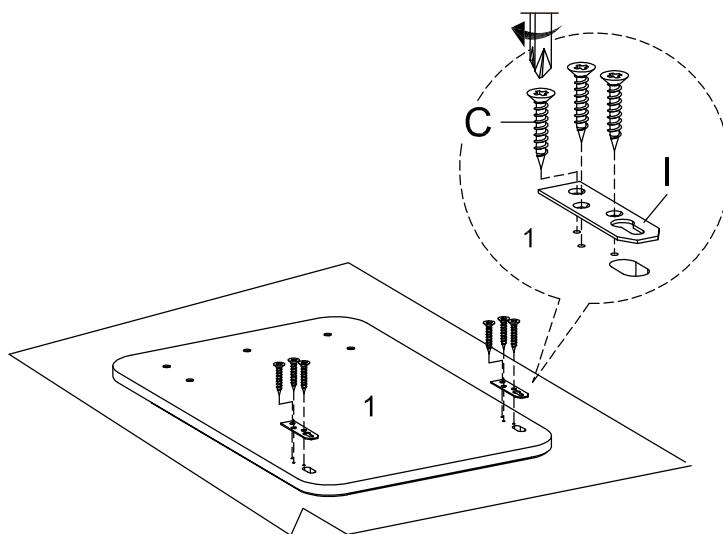

Step 2

HARDWARE

- D** Screw M 4 x 25 mm x3
- H** Handle x3

COMPONENTS

- 1** Mirror Board x1

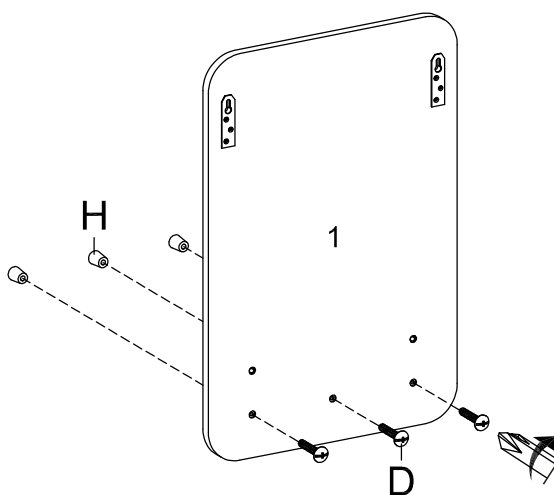

Step 3

HARDWARE

- B** Screw M 6.3 x 50 mm x2
- F** Allen Key x1

COMPONENTS

- 1** Mirror Board x1
- 2** Shelf x1

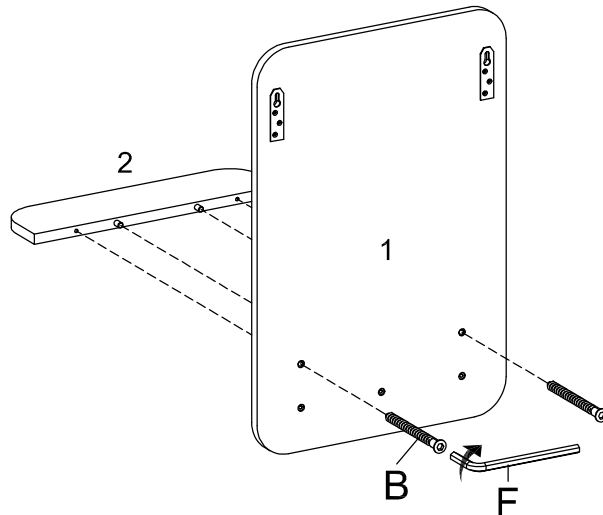

Step 4

HARDWARE

- E** Screw M 8 x 38 mm x2
- G** Fisher Ø8 mm x2

Different wall materials require unique wall fasteners. The wall plugs (G) and screws (E) are designed for fixing to concrete walls only. Please consult your local hardware store to ensure you are using the correct hardware for your wall type.

Step 1

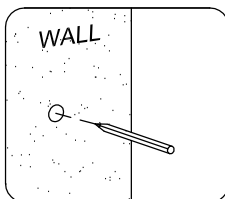

Step 2

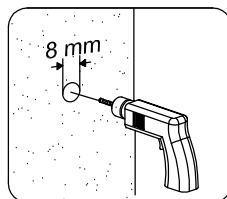

Step 3

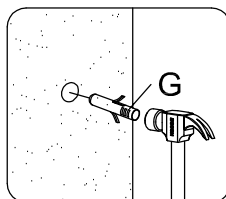

Step 4

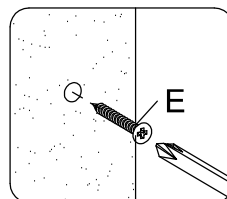

Step 5

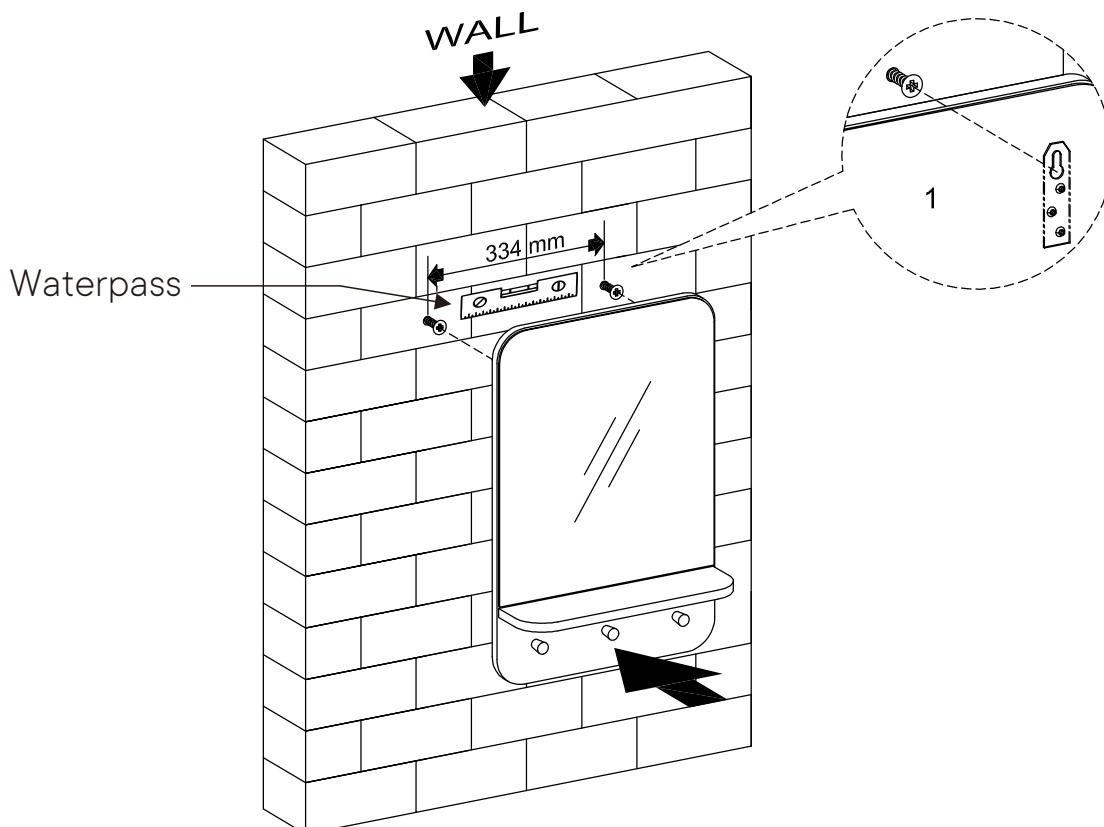
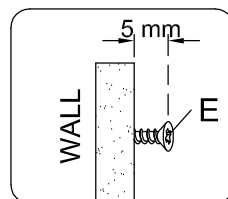

Great job!

Mirror assembly is complete

♥ CARING FOR YOUR ITEM

Indoor use only.

Not contract grade.

Clean using a non-abrasive cloth and a mild cleaner.

Never use harsh chemicals, as they could damage the finish or integrity of the item.

CONNECT WITH US!   

Tag us [@modway_furniture](#) and [#modway](#) for a chance to be featured.

