

# DURABOOK

Prepared for the Unexpected

# S14I Laptop Solution Guide





# S14I Laptop

## One Step Above Semi Rugged

The all-new Durabook S14I features the latest 11th Generation Intel® CPUs and class-leading 4' drop spec/ IP53 rating, pushing semi-rugged devices to a whole new level. The S14I is engineered to combine military-grade durability, field-worker functionality, computing performance, and long battery life for non-stop use, making it suitable for use in locations where rain or dust may be a regular occurrence. For workers in today's challenging and versatile working environments, the S14I rugged laptop is truly in a class of its own.

- 14.0" FHD DynaVue® SR display with 1000 nits
- 11<sup>th</sup> Generation Intel® Core™ Processor
- Wireless Wi-Fi 6 AX201 and Bluetooth® V5.1
- Up to 20 hrs. with 2nd battery
- Dedicated GPS and 4G LTE WWAN
- Customizable multimedia bay



# S14I LAPTOP SOLUTION ECOSYSTEM

**DOCKING SOLUTIONS**



**POWER MANAGEMENT SOLUTIONS**

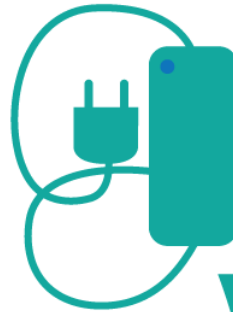

**PRODUCTIVITY SOLUTIONS**



**STORAGE SOLUTIONS**

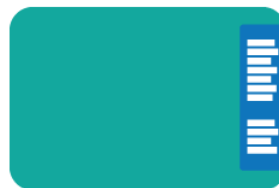

**WARRANTY SOLUTIONS**



## S14I Laptop SOLUTION ECOSYSTEM

Durabook's full range of solutions is designed to work with Durabook devices so you can be more productive with better security and connectivity.

All accessories in the guide are fully tested in-house and in the Durabook factory by Durabook Engineers.

# VERSATILE SOLUTIONS FOR THE MODERN WORKFORCE

**AUTOMOTIVE**



**FIELD SERVICE**



**GOVERNMENT**

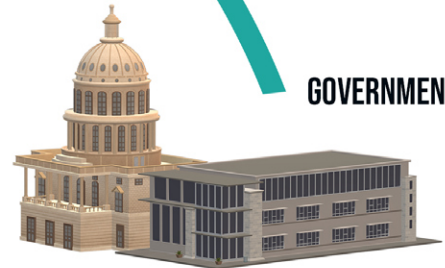

# VERSATILE SOLUTIONS FOR THE MODERN WORKFORCE

Built to meet the heightened needs of industry clients, Durabook's unmatched rugged product lineup has everything you need.

**PUBLIC SAFETY & EMERGENCY SERVICE**



**INDUSTRIAL MANUFACTURING**

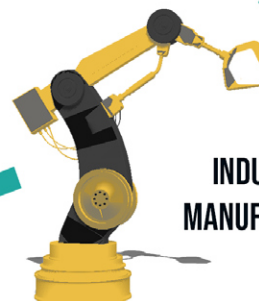

**UTILITY**

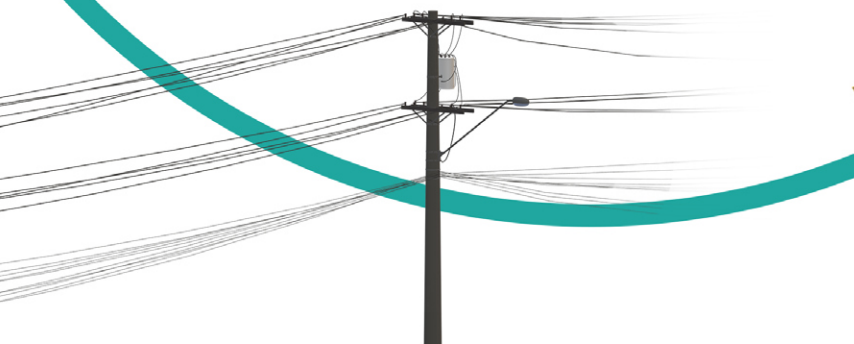



# DOCKING SOLUTIONS

## Office Dock with 120W AC Adapter

Ports:

- DC-in jack x 1
- 10/100/1000 Ethernet (RJ-45) x 1
- USB 3.0 (type A) x 2
- USB 2.0 (type A) x 2
- DP (DisplayPort) port x 1
- HDMI port (type A) x 1
- VGA port x 1
- Serial COM port (D-sub) x 1
- Audio out jack
- Microphone in jack



Size: 322 mm (W) x 321 mm (D) x 78 mm (H)

Weight: 2.88 kg

Part Number:

**DDXS4\_**

## Vehicle Dock with Tri-RF Pass-through (PMT)

Ports:

- DC-in jack x 1
- 10/100/1000 Ethernet (RJ-45) x 1
- USB 3.0 (type A) x 2
- USB 2.0 (type A) x 2
- DP (DisplayPort) port x 1
- HDMI port (type A) x 1
- VGA port x 1
- Serial COM port (D-sub) x 1
- Audio out jack
- Microphone in jack
- GPS/WWAN/WLAN Pass-through

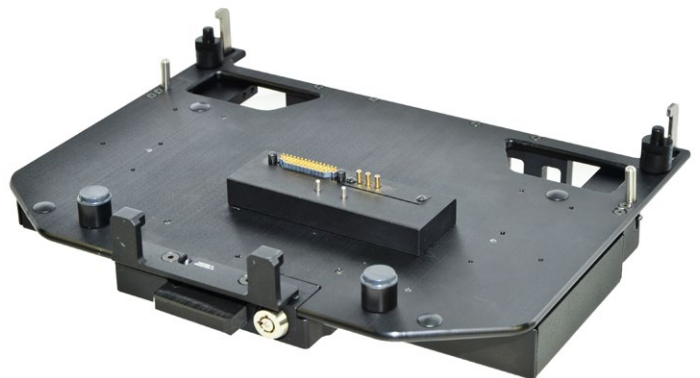

Size: 350 mm (W) x 294.6 mm (D) x 82.6 mm (H)

Weight: 3.42 kg

Part Number:

**TVPS4P**

Durabook.ca  
Ruggedbooks.com  
sales@ruggedbooks.com  
1-888-585-5388 x 110

# DOCKING SOLUTIONS

## Vehicle Dock without Tri-RF Pass-through (PMT)

Ports:

- DC-in jack x 1
- 10/100/1000 Ethernet (RJ-45) x 1
- USB 3.0 (type A) x 2
- USB 2.0 (type A) x 2
- DP (DisplayPort) port x 1
- HDMI port (type A) x 1
- VGA port x 1
- Serial COM port (D-sub) x 1
- Audio out jack
- Microphone in jack

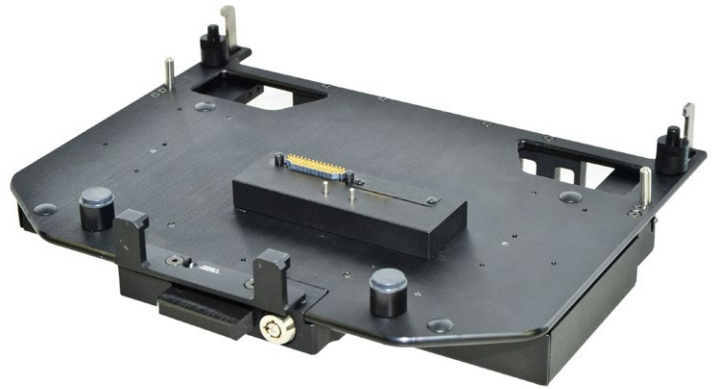

Size: 350 mm (W) x 294.6 mm (D) x 82.6mm (H)

Weight: 3.33 kg

Part Number:

**TVXS4P**

# POWER MANAGEMENT SOLUTIONS

## Spare Main Battery

Part Number:  
**DBMS4X**



## Removable 2nd Battery for media bay

Part Number:  
**DB2S4X**



## Battery Charger - 2 bays

Part Number:  
**DC2S4\_**



*Supports both main and second battery*  
*Supports up to three 2-Bay Chargers daisy chained together using the attached DC-out cable.*  
**Power Input:** 19V, 50-60Hz, 65W AC Adapter  
**Dimensions:** 151 mm (W) x 151 mm (D) x 95 mm (H)  
**Weight:** 0.64kg

## Battery Charger - 8 bays

Part Number:  
**DC8S4\_**



*Supports both main and second battery*  
*Supports battery calibration with the push of a button.*  
**Power Input:** 100-240V, 50-60Hz, 200W Internal Power Supply  
**Dimensions:** 550 mm (W) x 175 mm (D) x 103 mm (H)  
**Weight:** 4.5kg

## 90W AC Adapter with power cord

Part Number:  
**DAA9X\_**



## 120W AC Adapter with power cord

Part Number:  
**DAA2X\_**



## Car Adapter (11-32V DC 90W)

Part Number:  
**DAD4XX**



# PRODUCTIVITY SOLUTIONS

## Shoulder Strap (2 Point)

Part Number:  
**DMS2SX**



## Spare Stylus & Tether

Part Number:  
**DMSTXX**



## Screen Protector Film

Part Number:  
**DPFS4X**



## Removable Super Multi DVD for media bay

Part Number:  
**DEDS4X**





# STORAGE SOLUTIONS

## Spare PCIE SSD with canister

Part Numbers:

**DSMS44** - 1TB

**DSMS43** - 512GB

**DSMS42** - 256GB



## 2nd SSD for media bay

Part Numbers:

**DS2S43** - 512GB

**DS2S42** - 256GB



# WARRANTY SOLUTIONS

## Extended Warranty

Durabook's Extended Warranty provides up to an additional 4 years of warranty thereby minimizing the cost of repair throughout the lifecycle of your device.

Part Numbers:

**EW4-S14** - Extended Warranty - Years 1 to 4 (including 1 Year Extended Warranty)

**EW5-S14** - Extended Warranty - Years 1 to 5 (including 2 Year Extended Warranty)

**EW6-S14** - Extended Warranty - Years 1 to 6 (including 3 Year Extended Warranty)

**EW7-S14** - Extended Warranty - Years 1 to 7 (including 4 Year Extended Warranty)

## Accidental Damage Warranty (Protection Plus)

Durabook's Accidental Damage Warranty provides up to 7 years of warranty. With Durabook's Accidental Damage Warranty your Durabook rugged devices are covered for accidental damage.

Part Numbers:

**PP3-S14** - Accidental Damage Warranty - Years 1 to 3

**PP4-S14** - Accidental Damage Warranty - Years 1 to 4 (including 1 Year Extended Warranty)

**PP5-S14** - Accidental Damage Warranty - Years 1 to 5 (including 2 Year Extended Warranty)

**PP6-S14** - Accidental Damage Warranty - Years 1 to 6 (including 3 Year Extended Warranty)

**PP7-S14** - Accidental Damage Warranty - Years 1 to 7 (including 4 Year Extended Warranty)

## Extended Battery Warranty

Durabook's Extended Battery Warranty provides up to 5 years of warranty on the device's main standard battery providing you with a worry free solution for your workforce.

Part Numbers:

**EBW2-S14** - Extended Battery Warranty - 2 Years Cover (Main Standard Battery Only)

**EBW3-S14** - Extended Battery Warranty - 3 Years Cover (Main Standard Battery Only)

**EBW4-S14** - Extended Battery Warranty - 4 Years Cover (Main Standard Battery Only)

**EBW5-S14** - Extended Battery Warranty - 5 Years Cover (Main Standard Battery Only)

## Extended Warranty - Others

Durabook's other Extended Warranty provides up to 3 years of warranty on other Durabook Solutions.

Part Numbers:

**EDW2-S14** - Extended Durabook Office Dock Warranty - 2 Years Cover

**EDW3-S14** - Extended Durabook Office Dock Warranty - 3 Years Cover

# SOLUTION OVERVIEW

CATEGORY	ITEM	PART NO.
DOCKING SOLUTIONS	Office Dock with 120W AC Adapter	DDXS4_
	Vehicle Dock with Tri-RF Pass-through (PMT)	TVPS4P
	Vehicle Dock without Tri-RF Pass-through (PMT)	TVXS4P
POWER MANAGEMENT SOLUTIONS	Spare Main Battery	DBMS4X
	Removable 2nd Battery for media bay	DB2S4X
	Battery Charger - 2 bays	DC2S4_
	Battery Charger - 8 bays	DC8S4_
	90W AC Adapter with power cord	DAA9X_
	120W AC Adapter with power cord	DAA2X_
	Car Adapter (11-32V DC 90W)	DAD4XX
PRODUCTIVITY SOLUTIONS	Shoulder Strap (2 Point)	DMS2SX
	Spare Stylus & Tether	DMSTXX
	Screen Protector Film	DPFS4X
	Removable Super Multi DVD for media bay	DEDS4X
STORAGE SOLUTIONS	Spare 1TB PCIE SSD with canister	DSMS44
	Spare 512GB PCIE SSD with canister	DSMS43
	Spare 256GB PCIE SSD with canister	DSMS42
	2nd 512GB SSD for media bay	DS2S43
	2nd 256GB SSD for media bay	DS2S42
WARRANTY SOLUTIONS	<b>Extended Warranty</b>	
	Extended Warranty - Years 1 to 4 (including 1 Year Extended Warranty)	EW4-S14
	Extended Warranty - Years 1 to 5 (including 2 Year Extended Warranty)	EW5-S14
	Extended Warranty - Years 1 to 6 (including 3 Year Extended Warranty)	EW6-S14
	Extended Warranty - Years 1 to 7 (including 4 Year Extended Warranty)	EW7-S14
	<b>Accidental Damage Warranty (Protection Plus)</b>	
	Accidental Damage Warranty - Years 1 to 3	PP3-S14
	Accidental Damage Warranty - Years 1 to 4 (including 1 Year Extended Warranty)	PP4-S14
	Accidental Damage Warranty - Years 1 to 5 (including 2 Year Extended Warranty)	PP5-S14

# SOLUTION OVERVIEW

CATEGORY	ITEM	PART NO.
WARRANTY SOLUTIONS	Accidental Damage Warranty - Years 1 to 6 (including 3 Year Extended Warranty)	PP6-S14
	Accidental Damage Warranty - Years 1 to 7 (including 4 Year Extended Warranty)	PP7-S14
	Extended Battery Warranty	
	Extended Battery Warranty - 2 Years Cover (Main Standard Battery Only)	EBW2-S14
	Extended Battery Warranty - 3 Years Cover (Main Standard Battery Only)	EBW3-S14
	Extended Battery Warranty - 4 Years Cover (Main Standard Battery Only)	EBW4-S14
	Extended Battery Warranty - 5 Years Cover (Main Standard Battery Only)	EBW5-S14
	Extended Warranty - Others	
	Extended Durabook Office Dock Warranty - 2 Years Cover	EDW2-S14
	Extended Durabook Office Dock Warranty - 3 Years Cover	EDW3-S14