

SHEET TITLE : **AZTech 3500 FW2**

DRWG. NO.: **FW32-081307** DRAWN BY: **TAA**

DATE: **08/13/07** SCALE: **NTS**

**SPECIFICATIONS:**

- DIMENSIONS:** 53"H X 120" W X 26.5" D
- MOTOR:** 2 HP 208-230/460/3/60 TEFC  
6.0-5.8/2.9 FLA  
3 HP 230/3/60 TEFC  
8.6/4.3 FLA
- CFM:** 2 HP - 4000 CFM  
3 HP - 4500 CFM
- CONSTRUCTION:** 12, 14 & 16 GA POWDER COATED STEEL FRAME.  
3/16 POLYETHYLENE PANELS. FULL CARBON STEEL CONSTRUCTION AVAILABLE.  
4-WAY ALUMINUM EXHAUST GRILLE
- ELECTRICAL:** WIRED TO JCT. BOX  
OPT. MOTOR STARTER
- BLOWER:** 10 X 10 FORWARD CURVED BLOWER
- FILTERS:** 2" GALVANIZED BAFFLE PREFILTER  
4" PLEATED PREFILTER  
95% FIBERGLASS BAG FILTER
- OPTIONS:** HEPA AFTER FILTER  
SILENCER  
MAGNETIC PRESSURE GAUGE  
2" ALUMINUM MESH
- WEIGHT:** 534 lbs.
- NOISE:** 71.5 dBA  
72.0 dBA

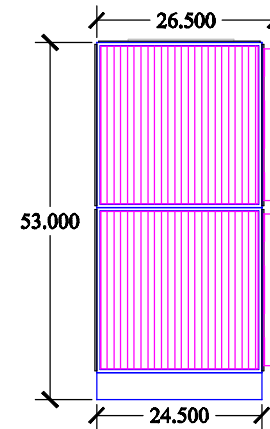
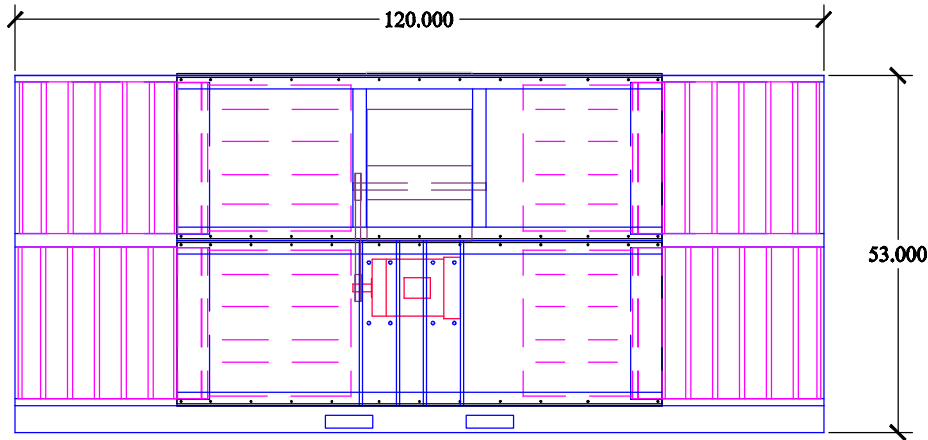

**COPYRIGHT:** This document and the information contained may not be reproduced or distributed without express written consent of INDUSTRIAL MAID. Unauthorized reproduction, disclosure, or manufacturing use are prohibited by copyright law.



**INDUSTRIAL MAID**  
INDUSTRIAL MAID LLC  
351 S. 12TH RD.  
CORTLAND, NE 68331  
Ph. (402) 798-7116  
Fax (402) 798-7117  
[www.industrial-maid.com](http://www.industrial-maid.com)

STATIC PRESSURE, W.G.

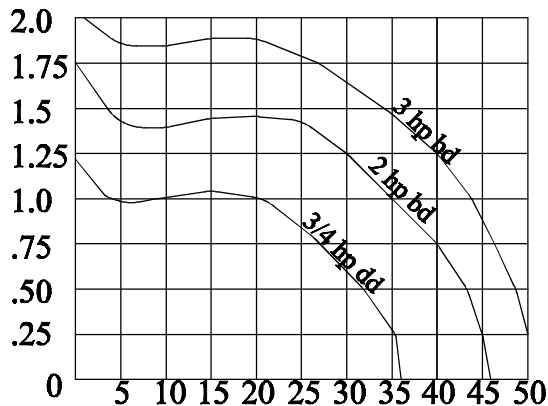

CFM X's 100

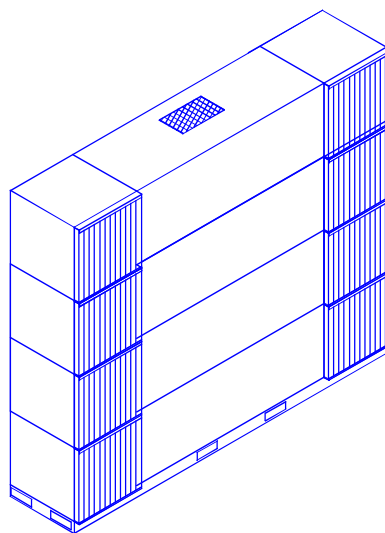

SHEET TITLE: AZTech 3500 FW4

DRWG. NO.: FW34-081307 DRAWN BY: TAA

DATE: 08/13/07

SCALE: NTS

**SPECIFICATIONS:**

**DIMENSIONS:** 102"H X 120" W X 26.5" D

**MOTOR:** 2 HP 208-230/460/3/60 TEFC  
6.0-5.8/2.9 FLA  
3 HP 230/3/60 TEFC  
8.6/4.3 FLA

**CFM:** 2 HP - 4000 CFM  
3 HP - 4500 CFM

**CONSTRUCTION** 7,12,14, & 16 GA POWDER COATED STEEL FRAME.  
3/16 POLYETHYLENE PANELS. FULL CARBON STEEL CONSTRUCTION AVAILABLE.  
4-WAY ALUMINUM EXHAUST GRILLE

**ELECTRICAL** WIRED TO JCT. BOX  
OPT. MOTOR STARTER

**BLOWER:** 10 X 10 FORWARD CURVED BLOWER

**FILTERS:** 2" GALVANIZED BAFFLE PREFILTER  
OPTIONAL - 2" ALUMINUM MESH  
4" PLEATED PREFILTER  
95% FIBERGLASS BAG FILTER

**OPTIONS:** HEPA AFTER FILTER  
SILENCER  
MAGNETIC PRESSURE GAUGE  
DIRECT DRIVE BI WHEEL

**WEIGHT:** 967 LBS.

**NOISE:** 71.5 dBA  
72.0 dBA

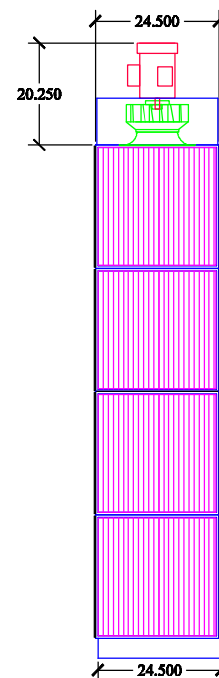
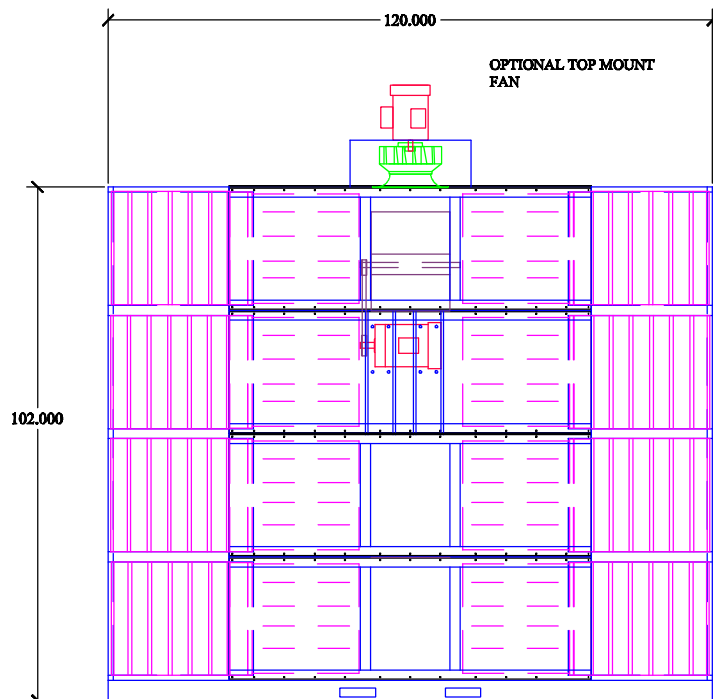

**COPYRIGHT:** This document and the information contained may not be reproduced or distributed without express written consent of INDUSTRIAL MAID. Unauthorized reproduction, disclosure, or manufacturing use are prohibited by copyright law.



**INDUSTRIAL MAID**  
INDUSTRIAL MAID LLC  
351 S. 12TH RD.  
CORTLAND, NE 68331  
Ph. (402) 798-7116  
Fax (402) 798-7117  
www.industrial-maid.com

STATIC PRESSURE, W.G.

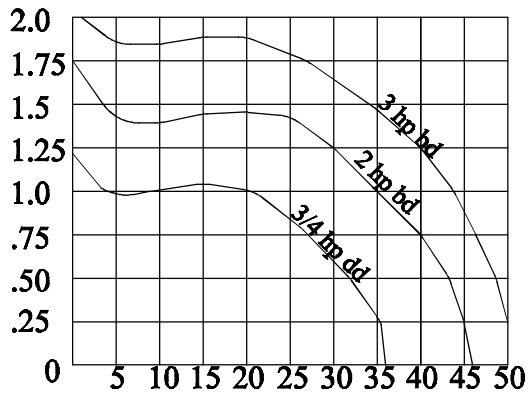

CFM X's 100

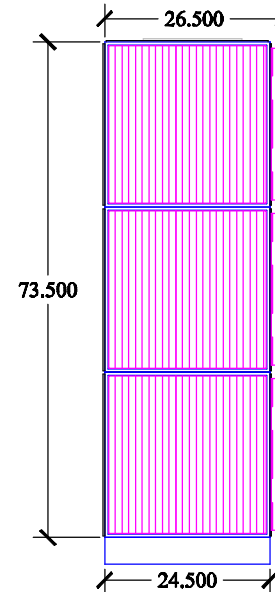
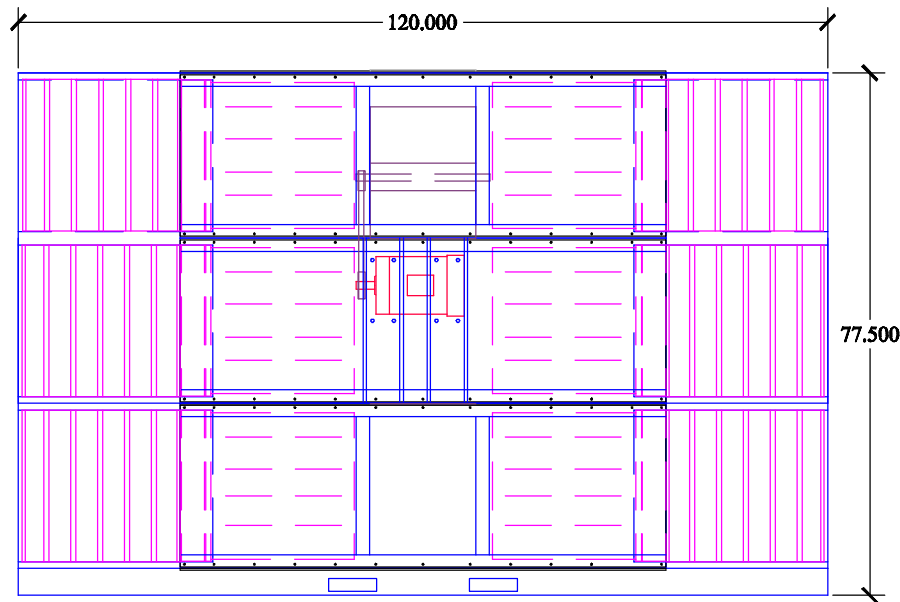
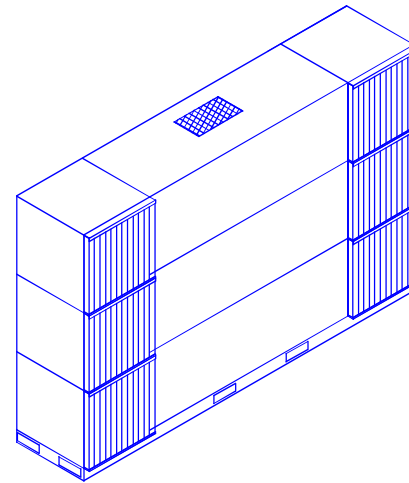

SHEET TITLE : **AZTech 3500 FW3**  
 DRWG. NO.: **FW33-081307** DRAWN BY: **TAA**  
 DATE: **08/13/07** SCALE: **NTS**

**SPECIFICATIONS:**

- DIMENSIONS:** 77.5" H X 120" W X 26.5" D
- MOTOR:** 2 HP 208-230/460/3/60 TEFC  
6.0-5.8/2.9 FLA  
3 HP 230/3/60 TEFC  
8.6/4.3 FLA
- CFM:** 2 HP - 4000 CFM  
3 HP - 4500 CFM
- CONSTRUCTION:** 7,12,14 & 16 GA POWDER COATED STEEL FRAME.  
3/16 POLYETHYLENE PANELS. FULL CARBON STEEL CONSTRUCTION AVAILABLE.  
4-WAY ALUMINUM EXHAUST GRILLE
- ELECTRICAL:** WIRED TO JCT. BOX  
OPT. MOTOR STARTER
- BLOWER:** 10 X 10 FORWARD CURVED BLOWER
- FILTERS:** 2" GALVANIZED BAFFLE PREFILTER  
4" PLEATED PREFILTER  
95% FIBERGLASS BAG FILTER
- OPTIONS:** HEPA AFTER FILTER  
SILENCER  
MAGNAHELIC PRESSURE GAUGE  
2" ALUMINUM MESH
- WEIGHT:** 795 lbs.
- NOISE:** 71.5 dBA  
72.0 dBA



**INDUSTRIAL MAID**  
 INDUSTRIAL MAID LLC  
 351 S. 12TH RD.  
 CORTLAND, NE 68331  
 Ph. (402) 798-7116  
 Fax (402) 798-7117  
 www.industrial-maid.com

**COPYRIGHT:** This document and the information contained may not be reproduced or distributed without express written consent of INDUSTRIAL MAID. Unauthorized reproduction, disclosure, or manufacturing use are prohibited by copyright law.