



5000Wh BATTERY SYSTEM(AU)



Dongguan Hinen New Energy Technology Co., Ltd

Add: No.24 Dongkang Road, Dalingshan Town,
Dongguan City, Guangdong Province, China
Tel: +86 (769) 8992 0666
Email: market@hinen.com
Website: <https://www.hinen.com>

User Manual

Foreword

- All information in this document is the property of the battery system manufacturer. Any parts of this document shall not be copied or reproduced in any commercial forms. Internal use allowed.
- The manufacturer makes no warranties or guarantees, express or implied, with respect to any device and/or software other than this product that may be described in this document, including, but not limited to, any implied warranties of merchantability, fitness for a particular purpose, accuracy or completeness of responses.
- In no event shall the manufacturer or its distributors or resellers be liable for indirect, incidental or consequential damages arising from non-compliance with the guidelines in this document.
- Specifications in this document are subject to change without notice. Every effort has been made to make this document complete, accurate and up to date. However, the manufacturer may require some improvements under certain circumstances without prior notice. The manufacturer shall not be liable for any damage caused by this document, including but not limited to omissions, typographical errors, arithmetic errors or errors listed in the document.

Disclaimer

The manufacturer shall not be liable for direct or indirect battery system damage or property loss caused under the following circumstances.

- Modify or replace parts without official authorization from the manufacturer.
- Change or clear the serial number by non-manufacturer technical professionals.
- System, assembled with other devices, design and installation fail to meet standards, safety regulations and other relevant requirements.
- Battery system damage caused by failure to comply with the user manual.
- Battery system damage caused by improper use or misuse.
- Battery system damage caused by insufficient ventilation.
- The maintenance procedures do not comply with acceptable standards.
- Battery system damage caused by force majeure, such as earthquake, storm, lightning, overvoltage, fire, etc.
- Battery system damage caused by any external factors.

Content

01 Safety precaution	1
02 Product introduction	2
2.1 Product description	2
2.2 Symbol definition	2
03 Battery introduction	3
3.1 Part introduction	3
3.2 Dimensions	4
04 Storage and package	5
4.1 Storage environment	5
4.2 Packing list	5
05 System installation	6
5.1 Installation environment	6
5.2 Space requirements	6
5.2.1 Floor mounting installation distance requirement	6
5.2.2 Wall mounting installation distance requirement	7
5.3 System installation	8
5.3.1 Unpack package	8
5.3.2 Floor mounting installation	8
5.3.3 Wall mounting installation	9
5.3.4 Cable connection	13
06 System operation	18
6.1 Check before power on	18
6.2 Power on	18
6.3 Battery parameter viewing and setting	19
6.4 Indicator status	22
6.4.1 Normal state	23
6.4.2 Alerting	24
6.4.3 Faulty	25
6.5 Power off	25
07 Technical parameters	26
08 Maintenance	27

01 Safety precaution

Danger!

- Please keep power off before any operations to avoid danger. Strictly follow all safety precautions outlined in this manual and safety labels on the equipment during operation.
- This manual applies to trained and knowledgeable technical professionals. The technical personnel has to be familiar with the product, local standards, and electric systems.
- Do not use the battery if it is defective, broken, or damaged.
- Do not disassemble, modify, or replace any parts of the battery without official authorization from the manufacturer.
- Battery damage may cause electrolyte leak. If leak happens, avoid contacting with the leaking liquid or gas, but contact the after-sales service as soon as possible.

Warning!

Anyone contacting the leaked substance accidentally has to do as follows:

- Breath in the leaked substance: Evacuate from the polluted area, and seek immediate medical assistance.
- Eye contact: Rinse your eyes for at least 15 minutes with clean water and seek immediate medical assistance.
- Skin contact: Thoroughly wash the touch area with soap and clean water, and seek immediate medical assistance.
- Ingestion: Induce vomiting, and seek immediate medical assistance.
- Do not move the battery system if it is connected with external battery modules. Contact after-sales service if the battery shall be replaced or added.

Caution!

Transportation:

- Protect the battery system from damage during transportation and storage.
- Be careful and consider the weight when lifting the battery.
- Do not hit, pull, drag, or step on the equipment or put irrelevant matter into any parts of the battery system .
- To protect the battery pack and its components from damage during transportation, please ensure that the transportation personnel are professionally trained. All operations during the transportation have to be recorded.
- The equipment shall be kept in balance, thus avoiding falling down, product damage and personnel injury.
- In the event of a fire, please make sure that the carbon dioxide extinguisher or Novac1230 or FM-200 is nearby.
- The fire cannot be put out by water or ABC dry powder extinguisher. Firefighters are required to wear full protective clothing and self-contained breathing apparatus.
- The battery may explode when the ambient temperature exceeds 150°C.
- The battery equipment is heavy. Please equip the corresponding personnel according to its weight, so that the equipment does not exceed the weight range of the human body can carry, and cause personnel injury.
- Place the cables at least 30mm away from the heating components or heat sources, otherwise the insulation layer of the cables may be aging or broken due to high temperature.
- Tie the cables of the same type together, and place cables of different types at least 30mm apart. Do not place the cables entangled or crossed.

02 Product introduction

2.1 Product description

This user manual introduces 5KWH storage battery system (hereinafter referred to as battery system), including the product introduction, application, installation, commission, maintenance and technical parameters, etc. The battery system can be compatible with H6000 inverter. At most 4 battery systems can be connected in parallel.

2.2 Symbol definition

Symbol	Description
	Potential risks exist. Wear proper PPE before any operations.
	High voltage hazard. Power off the equipment first before any operations.
	Operate the equipment properly to avoid explosion danger.
	The equipment contains corrosive electrolytes. In case of a leak in the equipment, avoid contacting the leaked liquid or gas.
	Read through the user manual before any operations.
	Pay attention to personal protection during installation and maintenance.
	Install the equipment away from fire sources.
	Keep the equipment away from children.
	Do not dispose of the equipment with household garbage at its end of life.
	Put the battery in the right place and recycle it in compliance with local environmental regulations.
	CE mark.
	RCM mark.
	Grounding. To indicate PE cable connection position.

03 Battery introduction

3.1 Part introduction

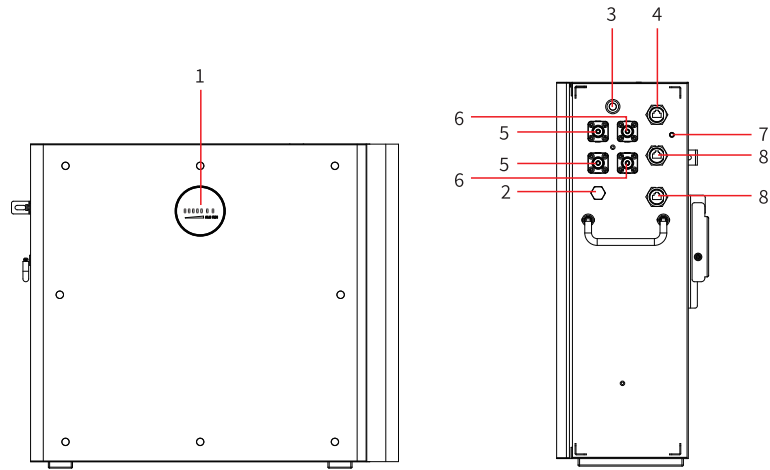

3.2 Dimensions

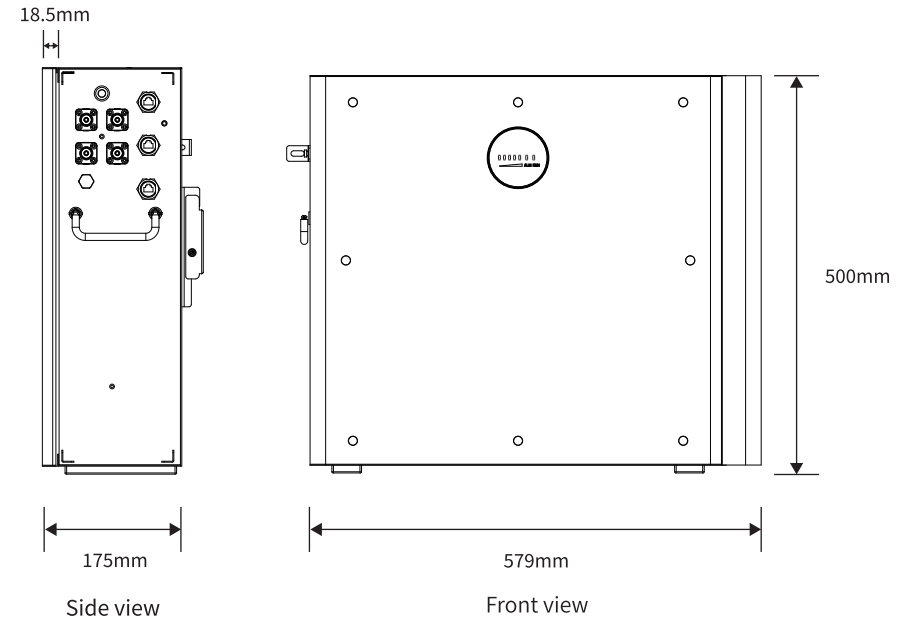

Port definition

No.	Part	Description
1	SOC indicator	Capacity indication, working together with the switch button to show battery status
2	Ventilation valve	Prevent too high air pressure inside the case
3	Switch button	Turn on/off the battery system
4	COM port 1	INV communication transmission
5	BAT+	Battery positive polarity power transmission
6	BAT-	Battery negative polarity power transmission
7	Grounding terminal	Grounding protection
8	COM port 2	Capacity expansion communication transmission

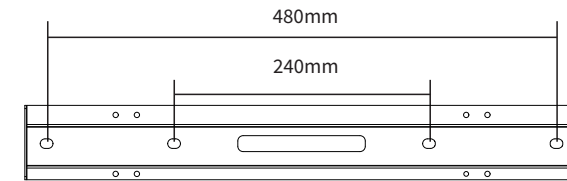

Mounting plate B

Note: The material of the external enclosure is SGCC (Steel Galvanized Cold Command). The face cover material is 1.0 mm thick and the chassis material is 1.5 mm thick.

04 Storage and package











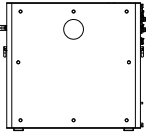



4.1 Storage environment

If the equipment is not to be installed or used immediately, please ensure that the storage environment meets the following requirements:

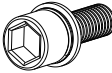
- Pack the equipment with a packing box and put some desiccant in the box before sealing.
- Put the equipment back to the packing box if it is not to be installed in 3 days after unpacking.
- Storage SOC: 25%~50%SOC. Charge and discharge the battery every 3 months.
- Recommended storage temperature: -20°C~40°C (less than one month) or 0°C~35°C (less than one year).
- Recommended storage humidity: 0%~95%RH (no condensation). Do not install the battery if any moist or condensation is found.
- Place the equipment in a cool place where away from direct sunlight.
- Keep the equipment away from inflammable, explosive, and corrosive matters.
- Keep the equipment away from rain.
- Place the equipment away from corrosive and organic materials and gases.
- Keep the equipment at least two meters away from heat sources (such as a radiator).
- Avoid exposure to intensive infrared radiation.

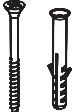
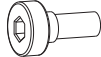
4.2 Packing list

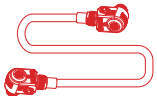
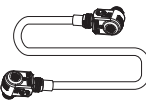
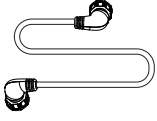
- Check outer packing for damage and model before unpacking it. If you find any damage or the model is not what you requested, do not unpack the product and contact the after-sales service as soon as possible.
- Check whether the deliverables are intact and complete first after unpacking the battery. If anything wrong, contact the after-sales service as soon as possible.

 Battery system x1	 Mounting plate A x4	 Mounting plate B x2	 Mounting plate C x4	 Side cover x1
 Anti-dumping bracket x2	 User manual x1	 Grounding terminal x1	 Hexagon socket screw x12	 M6 expansion bolt x8
 Expansion Bolt x2	 M4 screw x2	 M4 Phillips screw x2	 Silicone plug x2	 Red parallel cable x1
 Black parallel cable x1	 Parallel Signal cable x1	 SC25-8 Copper Terminal x2	 Screw nut x12	

05 System installation

5.1 Installation environment

- The 5000Wh battery system is installed indoors in a location that ensures that the use of the batteries is not obstructed by the building structure, fixtures and fittings in the room.
- The 5000Wh battery system is naturally ventilated. The installation location should be clean, dry and well ventilated. To ensure air circulation, install outside one meter of any vertical plane of a window or building vent that ventilates a habitable room.
- Entrance doors and panels to the room should open towards the exit and allow unobstructed access to the battery for installation and maintenance.
- Install the battery system on the ground with sufficient bearing capacity and flatness. If not, increase the bearing capacity and flatness of the ground by laying the foundation, adding bearing plates and so on.
- The optimal temperature for the battery is 20~40°C.
- Avoid exposing the equipment to direct sunlight or rain.
- Keep the equipment at least two meters away from heat sources, such as direct sunlight, a fireplace, a thermally uninsulated wall exposed to sunlight, hot water, or a heater.
- Install the equipment away from cold source.
- Do not install the equipment in the place where the temperature changes extremely.
- Install the equipment away from strong interferences to ensure its regular work.
- Keep children away from the equipment.
- Do not install the equipment in places prone to accumulating water.
- Do not put inflammable or explosive matters near the equipment.

5.2 Space requirements

5.2.1 Floor mounting installation distance requirement

Note Distances at both sides are recommended distances. Shorten the distance as much as possible in a proper range.

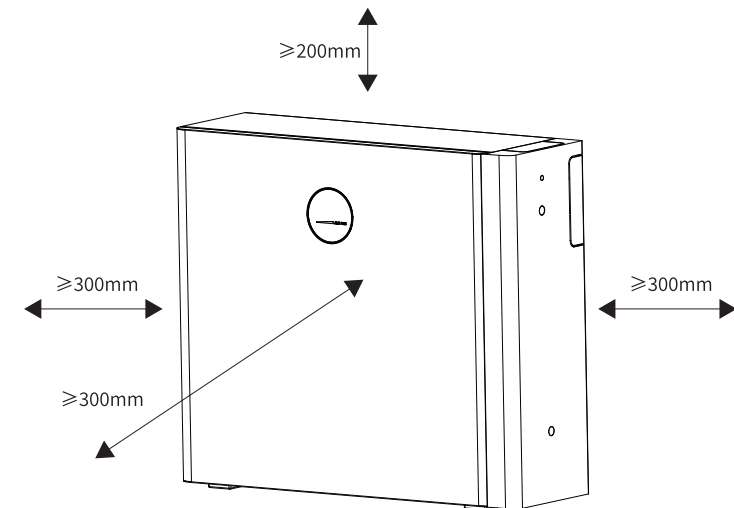

5.2.2 Wall mounting installation distance requirement

Note Distances at both sides are recommended distances. Shorten the distance as much as possible in a proper range.

Installed in single row

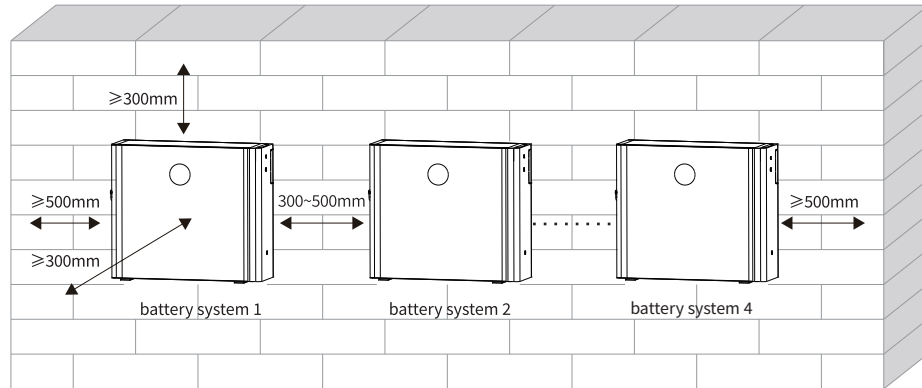

Installed in three rows

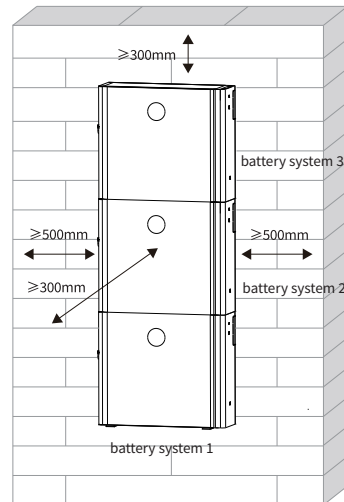

Installed in double rows

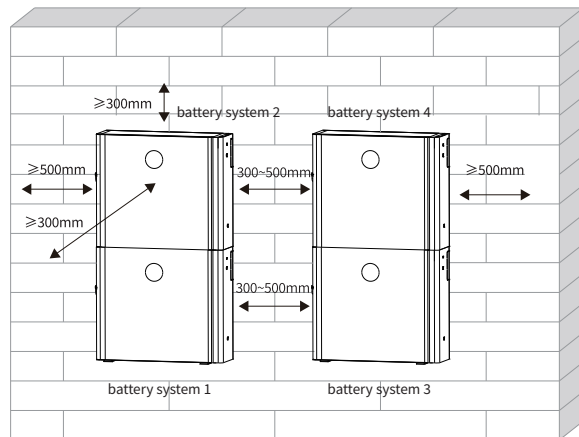

5.3 System installation

Note Battery systems in parallel shall be with close manufacturing dates and same range of OCV difference.

5.3.1 Unpack package

Open the carton to take out the accessories and battery system.

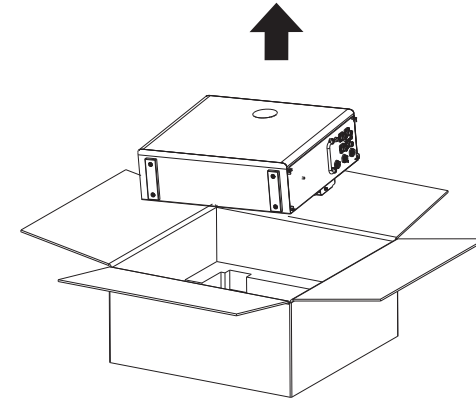

5.3.2 Floor mounting installation

Note Ensure the ground is flat and not tilted, and anti-dumping brackets are installed at both sides.

- Screw the anti-dumping bracket on the battery.
- Align the battery and the wall, then put the anti-dumping bracket close to the wall. Mark the drilling position and remove the battery.
- Drill a hole on the wall with a driller, hole diameter 10mm, depth 80mm.
- Fix the expansion bolts, tightening torque: 10N·m.

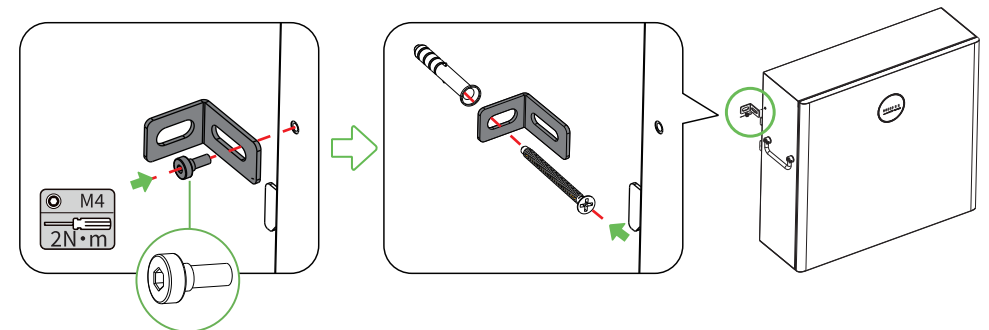

5.3.3 Wall mounting installation

Single installation

Note Wall mounting requires two people to install.

1. Use the screw nuts to secure the 2 mounting plates B and 2 mounting plates C together to form a combination backplate.
2. Position the combination backplate as a template so that the combination backplate is parallel to the ground and against to the wall. Make sure it is securely placed, use a marker to mark where to drill the holes, and remove the combination backplate.
3. Drill holes in the wall with an impact drill (hole diameter: 10mm, depth: 50mm).
4. Fasten the M6 expansion bolts with a torque of 10N-m.

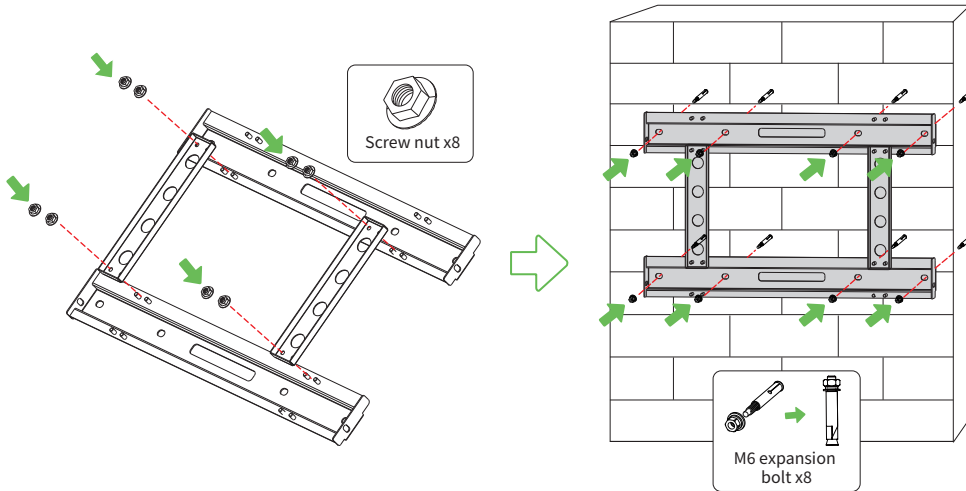

5. Install mounting plates A on the chassis, making sure it is installed securely.
6. Two people lift the handles on both sides respectively, lift the battery parallel to the ground, hang the installed mounting plates A on the mounting plates B of the combination backplate, and then fix it with screws.

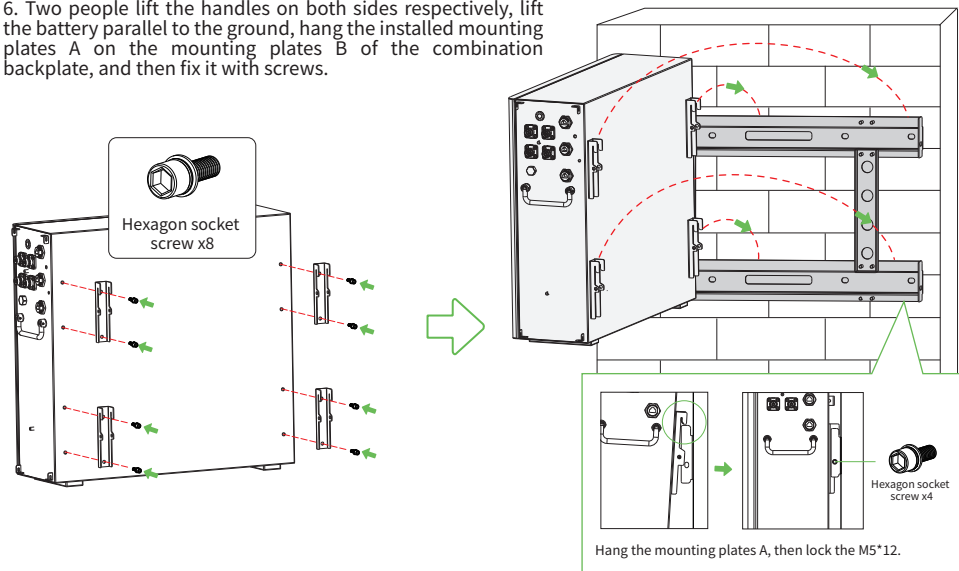

7. When wiring is complete, snap on the side cover, aligning the corners of the cover with the corner tabs on the side of the battery. (See the Wiring section for information on how to wire the battery).

8. Secure the side cover with M4 Phillips screws. (The side cover serves to protect the wiring.)

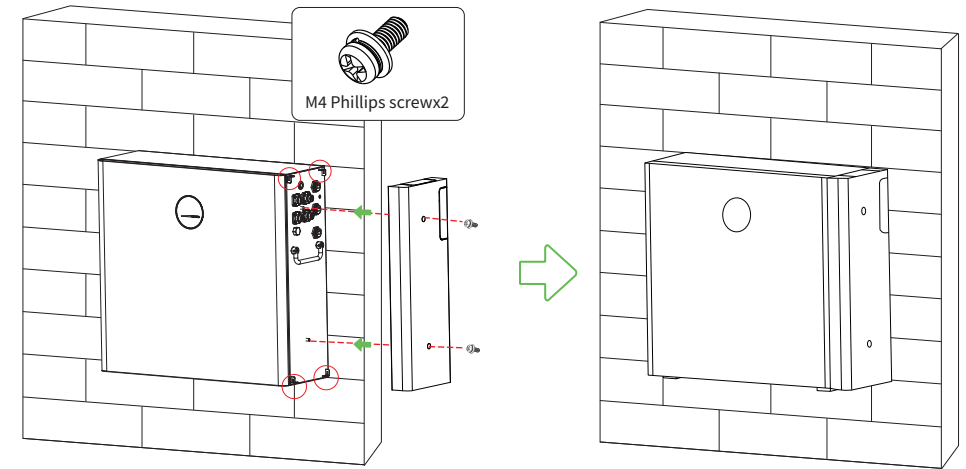

Stack installation

Note This method stacks up to 3 batteries! Below is an example of stacking 2 batteries.

1. Use the screw nuts to form 4 mounting plates B and 4 mounting plates C into 2 combination backplates each. (If you stack three batteries, you will need to assemble 3 combination backplates).
2. Use 2 mounting plates C to connect and fix the 2 combination backplates together.
3. Position the combination backplate as a template so that the combination backplate is parallel to the ground and against to the wall. Make sure it is securely placed, use a marker to mark where to drill the holes, and remove the combination backplate.
4. Drill holes in the wall with an impact drill (hole diameter: 10mm, depth: 50mm).
5. Fasten the M6 expansion bolts with a torque of 10N-m.

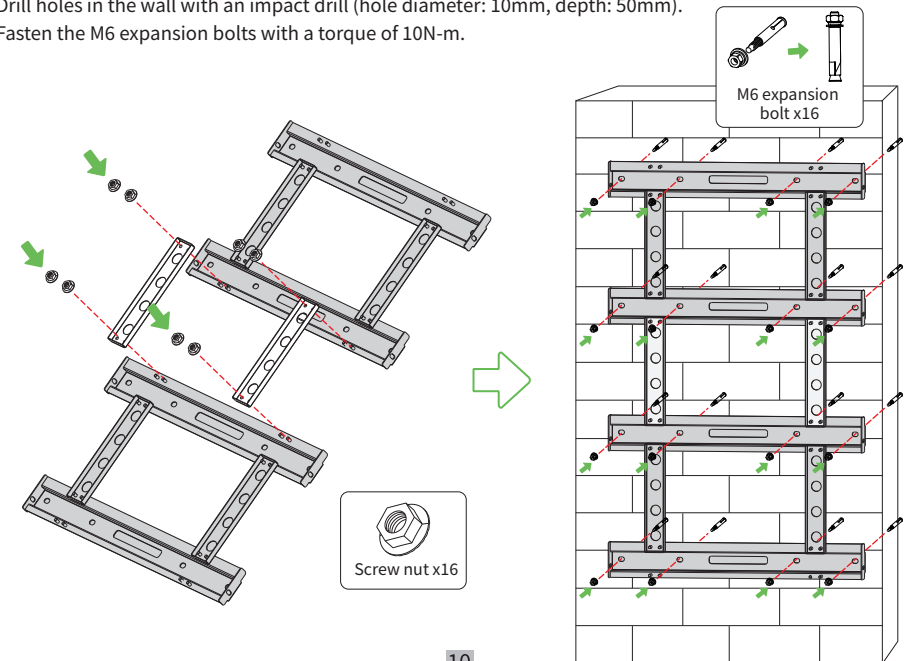

6. Attach the mounting plates A to each of the 2 chassis, making sure it is securely mounted.

7. Two people lift the first battery parallel to the ground by lifting the handles on both sides, and then hang the installed wall plate A into the wall plate B of the combination backplates below, and then fix it with screws.

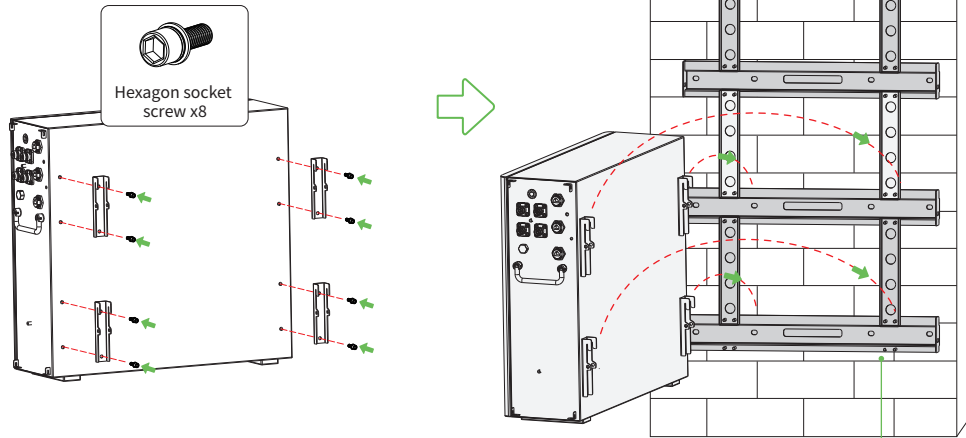

9. Remove the foot pad of the second battery.

10. After the foot pad is removed, two people lift the handles on both sides of the second battery and lift the battery parallel to the ground. Hang the mounting plate A into the mounting plate B of the combination backplate above, and then fix it with screws.

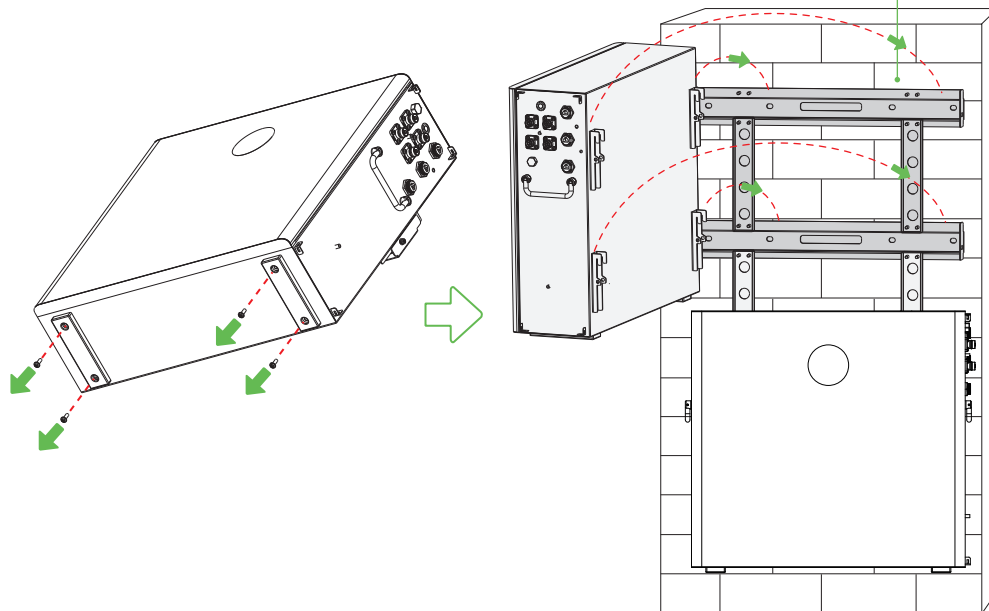

7. When wiring is complete, snap on the side cover, aligning the corners of the cover with the corner tabs on the side of the battery. (See the Wiring section for information on how to wire the battery).

8. Secure the side cover with M4 Phillips screws. (The side cover serves to protect the wiring.)

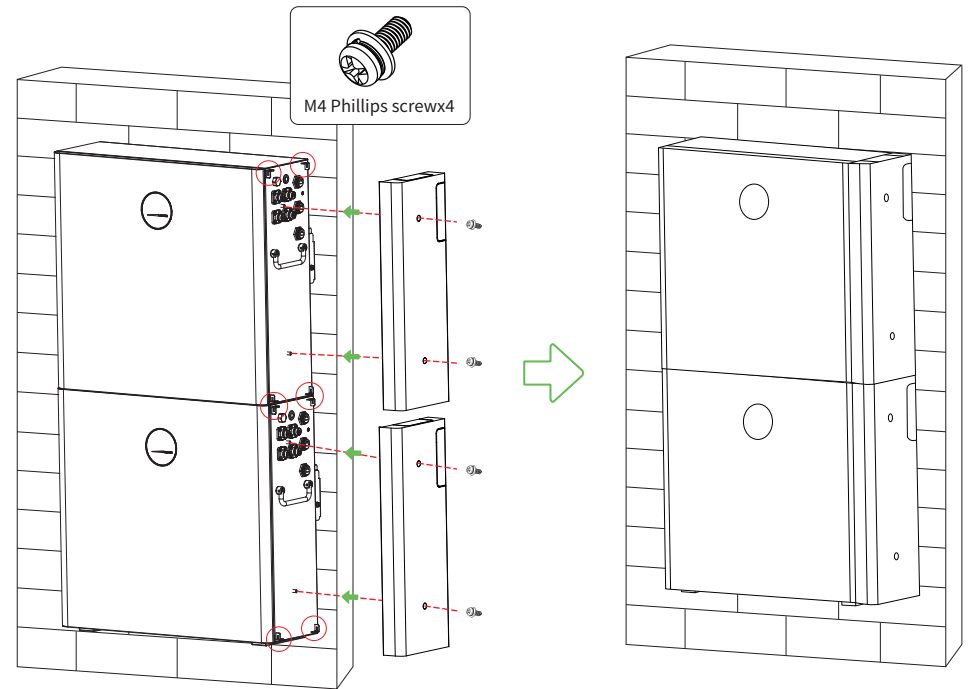

5.3.4 Cable connection

Cable connection overview

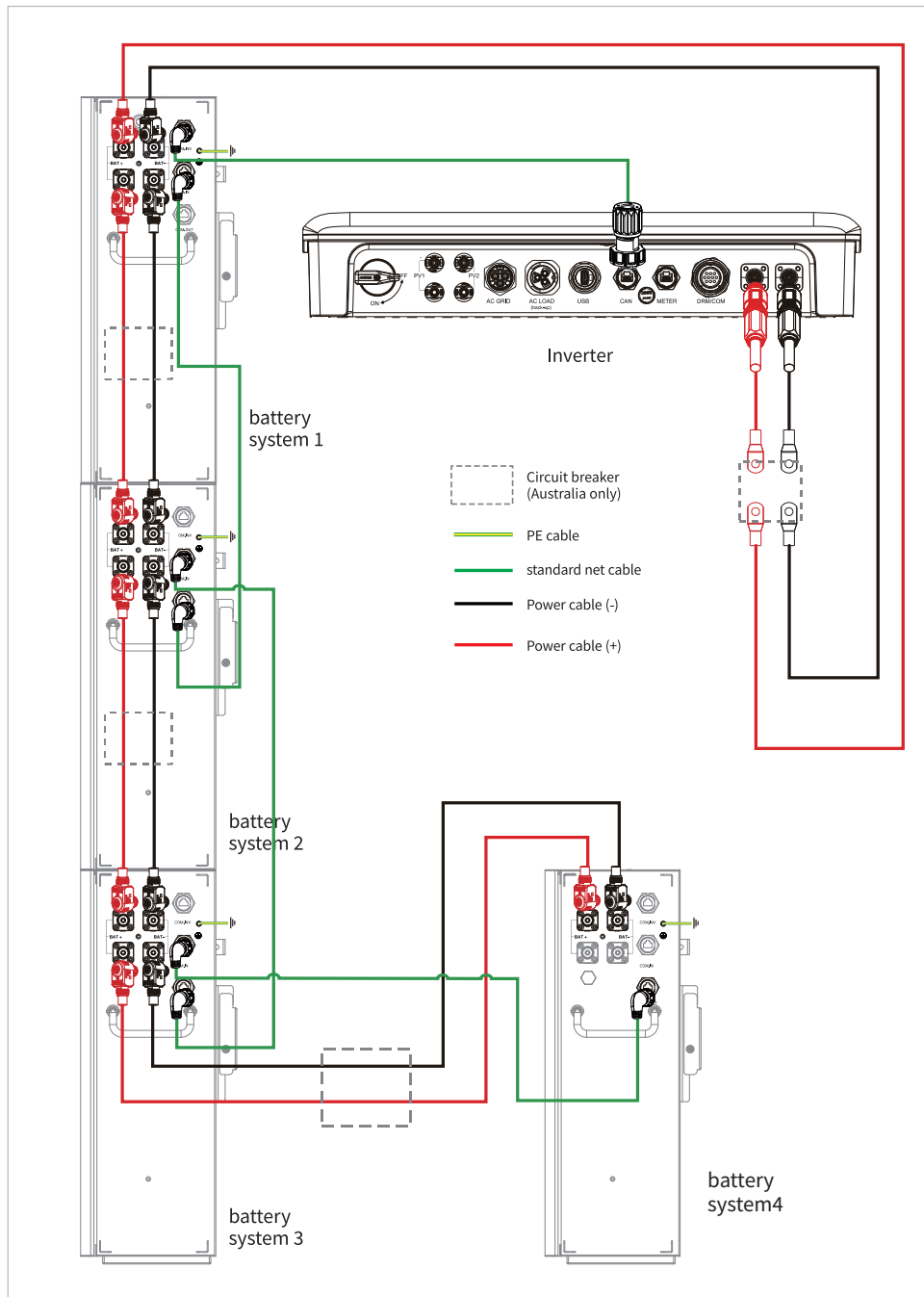

PE cable connection

Note

- Connect the PE cable first before installing the equipment. Disconnect the PE cable before dismantling the equipment.
- The drawing force of the cables after crimping is at least 400N.
- Connect any one of the two PE cables to the ground. Reserve the other cable.
- The cross-sectional area of the PE cable conductor: 5mm^2 . The cable should meet standards for outdoor use.
- Applicable screw: M5X12.

1. Crimp the PE cable.

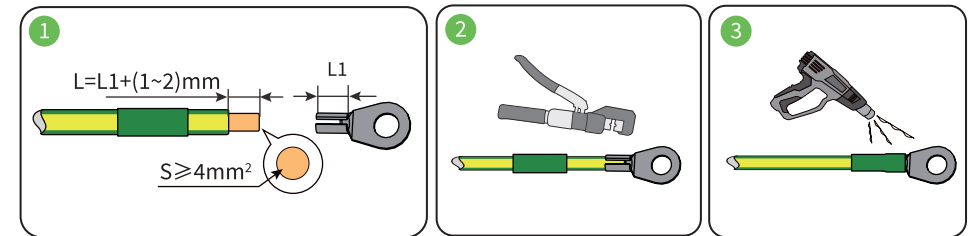

2. Connect the PE cable to the battery system.

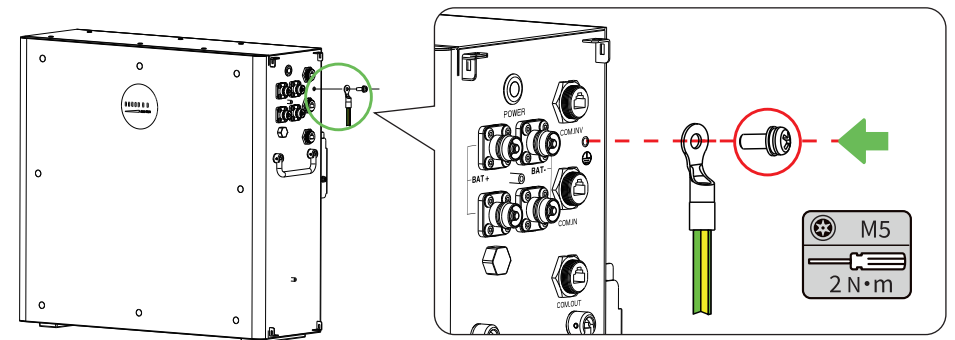

Power cable connection

Note

- Connect the red power cable to the red wire harness, and the black power cable to the black wire harness. The cross-sectional area of the crimping part is 25mm². The cable should meet standards for outdoor use.
- Withstand voltage: DC1500V, temperature: -40°C~200°C.
- Stripped conductor length: 18±1mm.
- Secure the back case and check whether there is any gap.
- Recommended tool: manual hydraulic press plier (mould:25mm²)
- Drawing force after crimping ≥1200N.
- If a single battery is applied, you are suggested to connect any one of the two power ports and cover the other port using the protective cover.
- Connect power cables between multi batteries in parallel, which means connect positive pole of one battery to the positive pole of the next battery, and negative pole to negative pole. Cover and protect the reserved power port of the last battery.
- The power cable between the batteries should be as short as it can be and meet installation requirements.

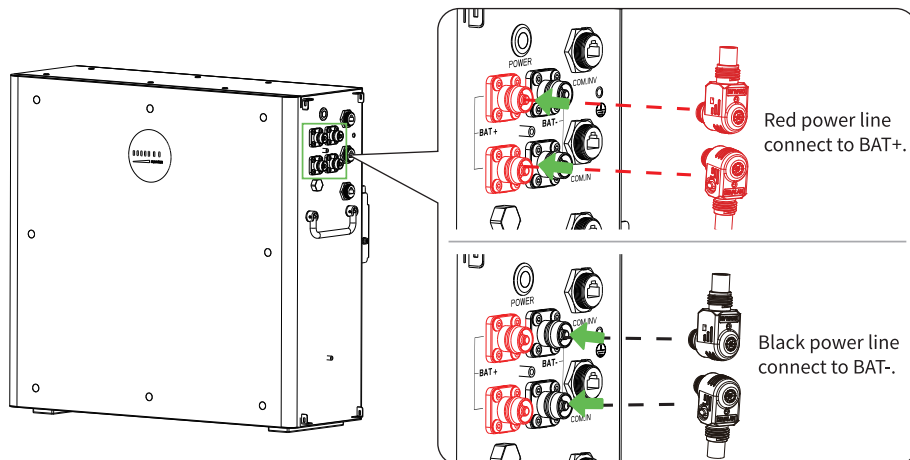
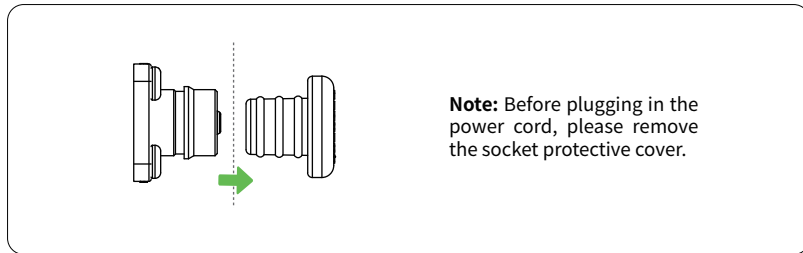

Communication cable connection

Note

The three communication cables are different. COM.INV is for inverter communication, COM.IN, COM.OUT for parallel communication.

- Do not use RJ45 cable with protective cover.
- When one battery is applied, insert the RJ45 connector into the COM.INV port.
- When multiple batteries are applied in parallel, connect the communication ports in series by net cables. Connect COM.IN of battery #1 and COM. OUT of #2, COM. IN of #2 and COM.OUT of #3. In such a way, at most 10 batteries shall be connected in parallel.

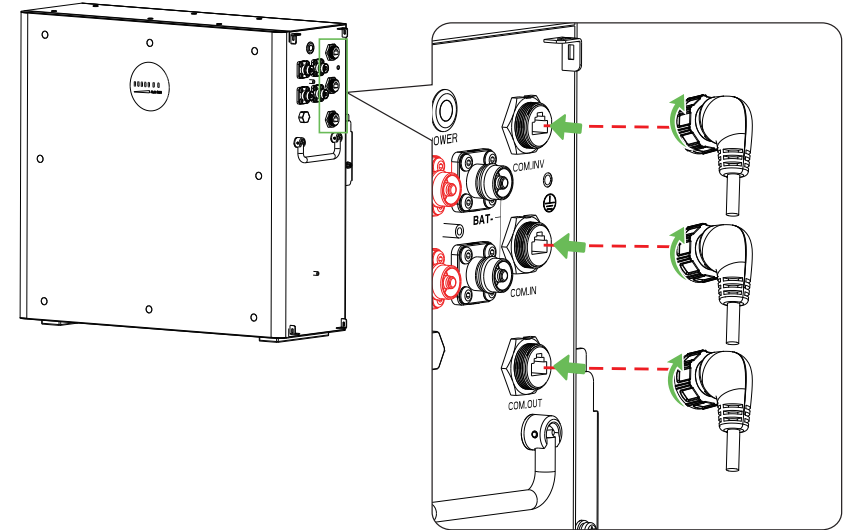

RJ45 communication port

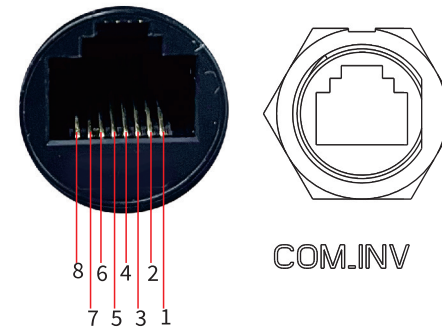

COM_INV ports definition

RJ45 PIN	Definition	Remark
1	SLEEP_WKP	
2	GND	
3	NC	Void
4	CANH	
5	CANL	
6	NC	Void
7	RS485-A	
8	RS485-B	
RJ45 PIN definition for inverter & BMS communication		

RJ45 communication port

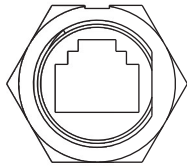
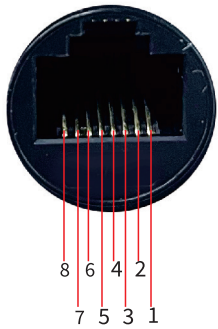

COM.IN

COM_IN ports definition

RJ45 PIN	Definition	Remark
1	CANL	
2	IUIP	
3	CANH	
4	I_READY	
5	GND	
6	O_WKUP	
7	NC	Void
8	NC	Void
RJ45 PIN definition for BMS parallel input communication		

RJ45 communication port

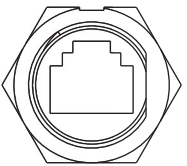
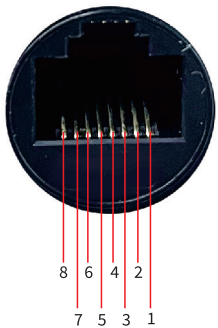

COM.OUT

COM_OUT ports definition

RJ45 PIN	Definition	Remark
1	CANL	
2	GND	
3	CANH	
4	O_READY	
5	GND	
6	I_WKUP	
7	NC	Void
8	NC	Void
RJ45 PIN definition for BMS parallel input communication		

06 System operation

6.1 Check before power on

Check the following items before power on. Otherwise, the battery system may be damaged.

No.	Items
1	The equipment is installed firmly in a place where is convenient for operation and maintenance. The installation place is clean and well ventilated.
2	The ground cable, power cable, communication cable and terminal resistance are connected correctly and securely.
3	The cable ties meet the cabling requirements and are reasonably distributed. No cables or ties are broken.
4	Unused ports are sealed.

6.2 Power on

Note

The circuit breaker between the inverter and the battery and the circuit breaker between the battery and the battery must be installed in accordance with local laws and regulations.

All circuit breakers are cooperate in all live (a.c. - active and neutral or d.c. - positive and negative) conductors.

The breaker should isolate both positive and negative conductors simultaneously and can ensure that any energized parts are isolated prior to any maintenance, installation, repair or replacement activities.

Step 1 (Optional) Close the circuit breaker between the inverter and battery system.

Step 2 (Optional) Close the circuit breaker between the battery and battery system. (When multiple machines are connected in parallel.)

Step 3 Press the battery button switch. (When using in parallel, just press the battery button switch that communicates with the inverter.)

Single battery system

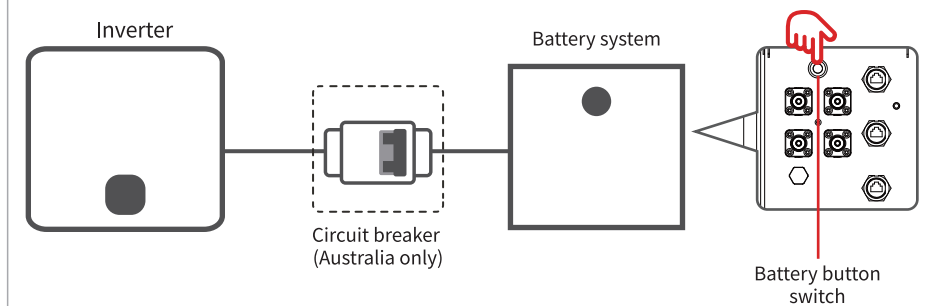

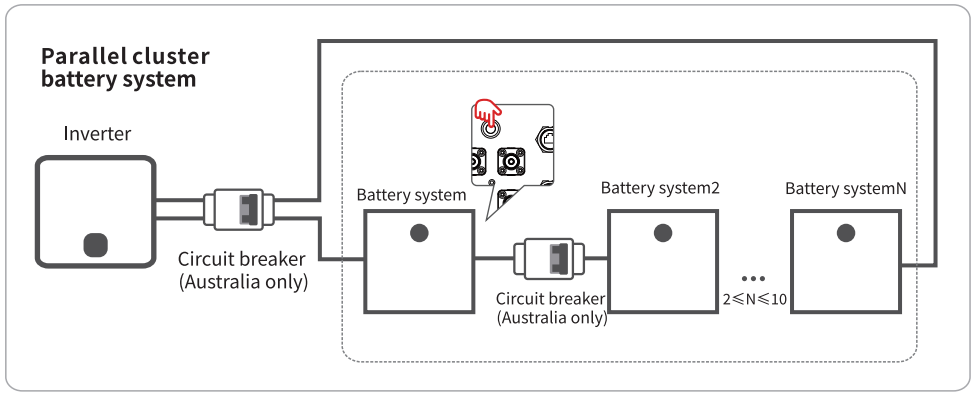

Low voltage DC miniature circuit breaker (125 series)

- *No polarity and bidirectional protection. *Short circuit protection and overload protection.
- *High breaking capacity, up to 10kA.
- *Ui: 500Vdc *Ue: 80/160Vdc *In:125A

6.3 Battery parameter viewing and setting

Select the right options on SOLARMAN Smart after connecting the battery and the inverter.

• APP Installatin and Connection:

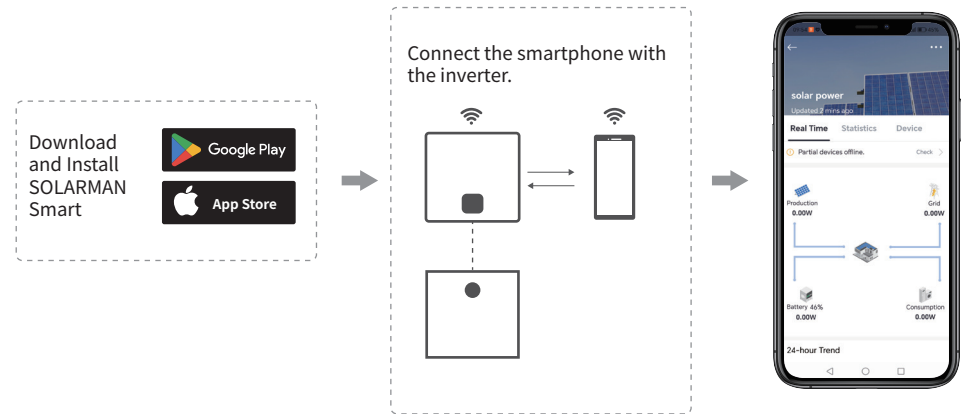

• View Battery Parameters
Click on the inverter connected to the battery to open the corresponding interface to view the battery parameters.

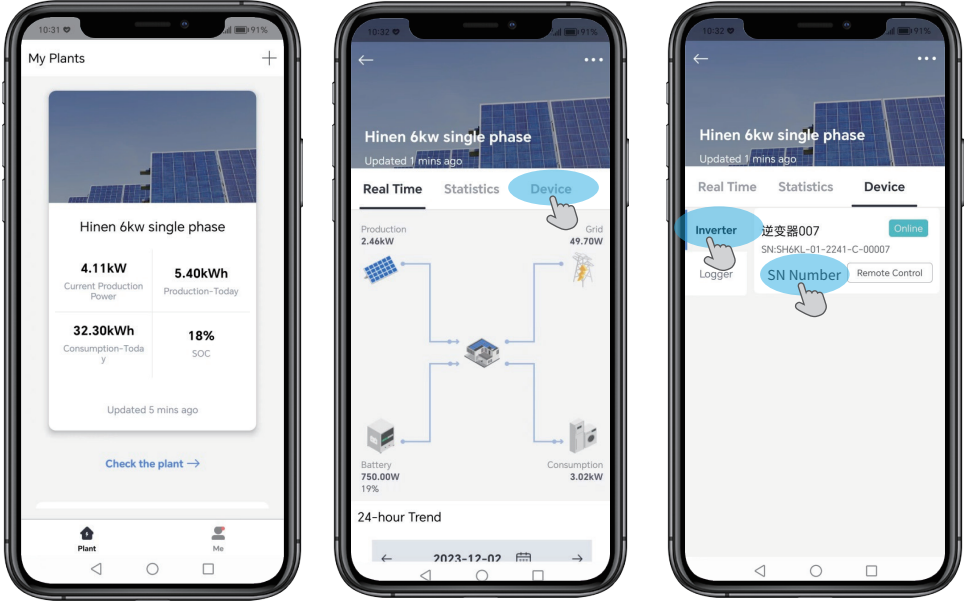

Battery	
Battery Status: Discharging	Battery Charging Type: Lithium Battery
Battery Voltage: 51.90V	Battery Voltage1: 52.20V
Battery Power: 690.00W	Battery Discharging Power: 690.00W
Battery Charging Power: 0.00W	SoC: 18%
SoH: 97%	Total Charging Energy: 10.10kWh
Total Discharging Energy: 15.40kWh	Daily Charging Energy: 1.80kWh
Daily Discharging Energy: 1.50kWh	Highest Individual Voltage No.: 0
Lowest Individual Voltage Number: 0	Highest Temperature Number: 0
Lowest Temperature Number: 0	Battery Factory: 3
Cycle Count: 0	Pack Fault ID: 0
Battery Maximum Soc: 0	Minimum Battery Soc: 0
BDU_Battery_Number: 0	

Battery

Here is the information about the batteries assigned to the system: current battery status, battery type, battery host voltage, battery slave voltage, battery power, battery charging power, battery discharging power, remaining battery capacity (SOC), battery health index (SOH), cumulative battery charging, cumulative battery discharging, battery charging on the day, battery discharging on the day, and so on.

BMS	
BMS Voltage: 51.80V	BMS Current: -10.00A
BMS Temperature: 19.50°C	BMS Max Charge Current: 71.40A
BMS Max Discharge Current: 89.60A	BMS_SOC: 18%
battery cell maximum temperature: 0.00°C	Minimum temperature of battery cell: 0.00°C
Maximum Pressure Difference Of Single Cell: 0	Battery CV Voltage: 57.60V
Highest Monomer Voltage: 0.00V	Lowest Monomer Voltage: 0.00V
Number Of Batteries In Parallel: 1	Gauge RM: 0
Gauge FCC: 0	

BMS

Here is the main battery management system BMS related information, including BMS battery voltage, BMS battery current, BMS temperature, BMS maximum charging current, BMS maximum discharging current, BMS SOC and so on.

Enter the number corresponding to the battery protocol and send the command.

Battery Protocol Code		
	Single-phase inverter	Three-phase inverter
0		PYLON Protocol
1		HINEN Protocol
2		Growatt Protocol
3		Growcol Protocol
4		SHOTO Protocol
5		GoodWE Protocol
6		YUZEI Protocol
7-20		Battery 7~20

Note: Please select the correct battery protocol, one side of the battery system can not be normal.

• Select Battery Protocol

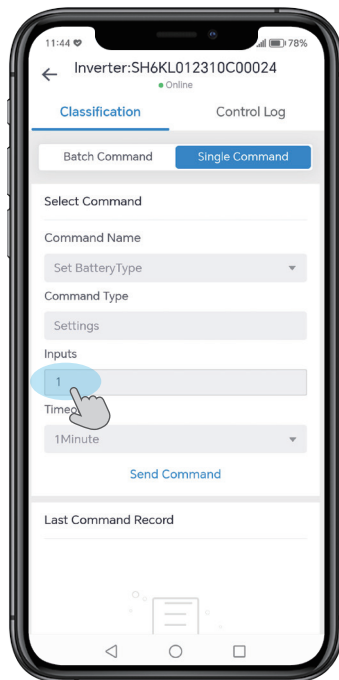



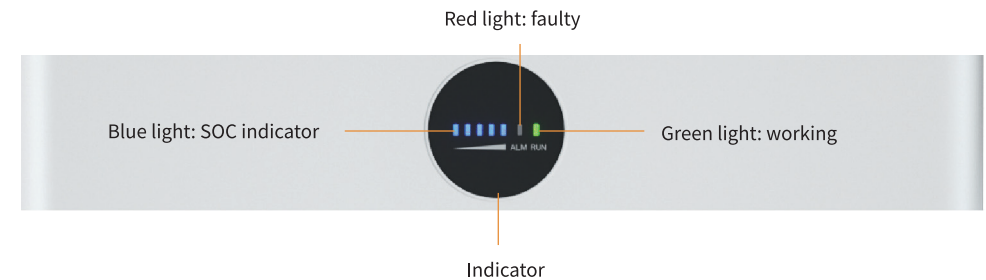

6.4 Indicator status



Indicator	Status
Green light	Standby, working
Red light	Alert, faulty
Blue light	SOC indicator

6.4.1 Normal state





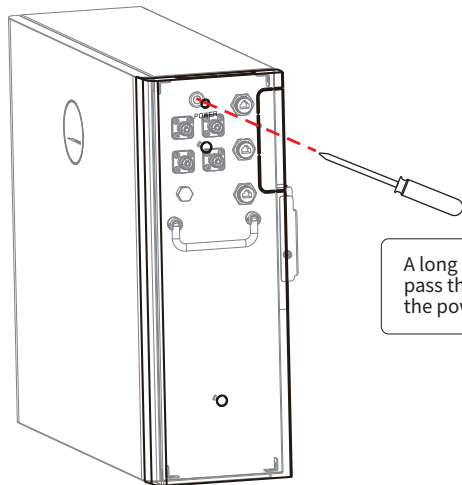













SOC indicator	Description
	0%<SOC<20%
	20%<SOC<40%
	40%<SOC<60%
	60%<SOC<80%
	80%<SOC<100%

If the battery does not work properly, press and hold the power switch button for 10s to reset.



A long tool can be used to pass through this hole to press the power switch button.

6.4.2 Alerting

Button Indicator	SOC indicator	Alerting	Solution
Red light blinks		Battery over voltage	Restart the battery. If it's still not fixed, contact customer service.
		Single unit pressure difference is too large	Charge the battery, waiting for the voltage to recover.
		Unit under voltage	
		VTOP under voltage	
		VTOP over voltage	Restart the battery. If it's still not fixed, contact customer service.
		Battery over temperature	Turn off and wait for 2 hours. If it's still not fixed, contact customer service.
		Battery low temperature	Turn off, wait the temperature to recover, restart the battery. If it's still not fixed, contact customer service.
		Overcurrent when charging	Restart the battery. If it's still not fixed, contact customer service.
		Overcurrent when discharging 1	
		Overcurrent when discharging 2	
		Short when discharging	Turn off, remove and check equipment, restart the battery. If it's still not fixed, contact customer service.
		Short when charging	
		PCB over temperature	Turn off and wait for 2 hours. If it's still not fixed, contact customer service.
		Pre-charge resistor over temperature	
		MOS temperature is too high	Charge the battery, waiting for the voltage to recover.
		IUIP parallel signal fault	Turn off, check the communication cable, restart the battery. If it's still not fixed, contact customer service.
		I_WORK parallel signal fault	
		Parallelization over time	
	Parallelization readiness failure		

Remark

- It is recommended to restart by the switch button.
- When running in parallel, after the battery under-voltage protection and under-voltage protection are powered off, just click the battery button switch that communicates with the inverter to force activation.

6.4.3 Faulty

Button Indicator	SOC indicator	Alerting	Solution
Red light always on		Battery voltage sampling wire broken	Restart the battery. If it's still not fixed, contact customer service.
		MOS failure	
		AFE communication failure	
		EEPROM failure	
		Voltage sensor failure	
		Extremely high battery voltage fault	Contact customer service.
		Main circuit fault	
		Pre-charge over time	Restart the battery. If it's still not fixed, contact customer service.
		Current sensor failure	
		Dead battery	
		Inverter communication failure	Turn off, check the communication cable. If it's still not fixed, contact customer service.
		CAN bus failure	
		RS485 bus failure	
		Parallel address recognition failure	
	Short circuit protection fuse circuit fault	Contact customer service.	

6.5 Power off

Please follow the steps to power off the Battery System, otherwise, the System may be damaged.

Step 1 Press the power button for more than 3 seconds until the indicator lights off. If multiple batteries are connected, press only the battery power button that communicates with the inverter.

Step 2 Disconnect the circuit breakers of all batteries.

Step 3 Make sure that the SOC indicator of the battery is off.

07 Technical parameters

Model	B5000 x1	B5000 x2	B5000 x3	B5000 x4
Product name	Rechargeable Li-ion Battery Pack (5.12kWh)	Rechargeable Li-ion Battery Pack (10.24kWh)	Rechargeable Li-ion Battery Pack (15.36kWh)	Rechargeable Li-ion Battery Pack (20.48kWh)
Rated Energy ¹	5.12kWh	10.24kWh	15.36kWh	20.48kWh
Usable capacity	4.6kWh	9.21kWh	13.82kWh	18.43kWh
Battery type	LFP(LiFePO ₄)			
Battery configuration	16S1P	16S2P	16S3P	16S4P
Maximum modules in parallel	4			
Cycle life ²	8000 cycles			
Rated voltage	51.2 V			
Operating voltage range	40~57.6 V			
Peak current	120A 60S			
Depth of Discharge (DOD)	90%	90%	90%	90%
Max. continuous charge / discharge current	100A	120A	120A	120A
Rated power	5.12KW	6.14KW	6.14KW	6.14KW
Short-Circuit Current	800A@0.1mS			
Run Log Recording	32M-byte			
Communication	CAN			
Weight	51.8KG	103.6KG	155.4KG	207KG
Dimensions (W*H*D)	579*500*175mm	579*1000*175mm	579*1500*175mm	(579*1000*175mm) x2
Operating temperature	Charge: 0°C < T < 55°C / Discharge: -20°C < T < 55°C			
Storage temperature	-20~40°C (≤ One month) / 0~35°C (≤ One year)			
Humidity	≤ 10~85%			
Altitude	≤ 2000m			
Ingress protection rating	IP65			
Installation type	Wall-mounted/ Floor stand			
Warranty ³	10 Years Warranty, 10 Years Performance Life			
Country of manufacture	Made in China			

Rated Energy¹: Test conditions, Fresh battery, 0.33C charge & discharge at +25°C.

Cycle life²: Test conditions, 90%DOD, 0.2C charge & discharge at +25°C.

Warranty³: Refer to battery warranty letter for conditional application.

08 Maintenance

Item	Period
Fully charge the battery and discharge it to 25~50% if the battery is not in use.	Once every 3 months
Check the wall mounting plate, fix it if it is not secured.	Once every 6 months
Check whether the outer shell is broken. Repair the painting or contact after-sales service if there is any broken.	Once every 6 months
Check whether there is an exposed cable. Replace the exposed cable or contact after-sales service for help.	Once every 6 months
Check whether there is debris accumulation around the battery to avoid affecting heat dissipation.	Once every 6 months
Check for water and pest to avoid prolonged intrusion.	Once every 6 months

Warning!

- Please contact after-sales for help if you find any problems that may influence the battery or the inverter. Disassemble without permission is strictly forbidden.
- Please contact after-sales for help if the conductive wire is exposed because high voltage danger exists. Do not touch or disassemble privately.
- In case of other emergencies, contact the after-sales as soon as possible. Please operate following the guidance of the after-sales, or just wait for the after-sales service operators.