

ASSEMBLY INSTRUCTION

Datos del importador
R/ España
C/ Industrias 2, Alcorcón
G79508701

Instrucciones de mantenimiento y de limpieza; aplicar productos de limpieza en seco y guardar en un lugar seco.

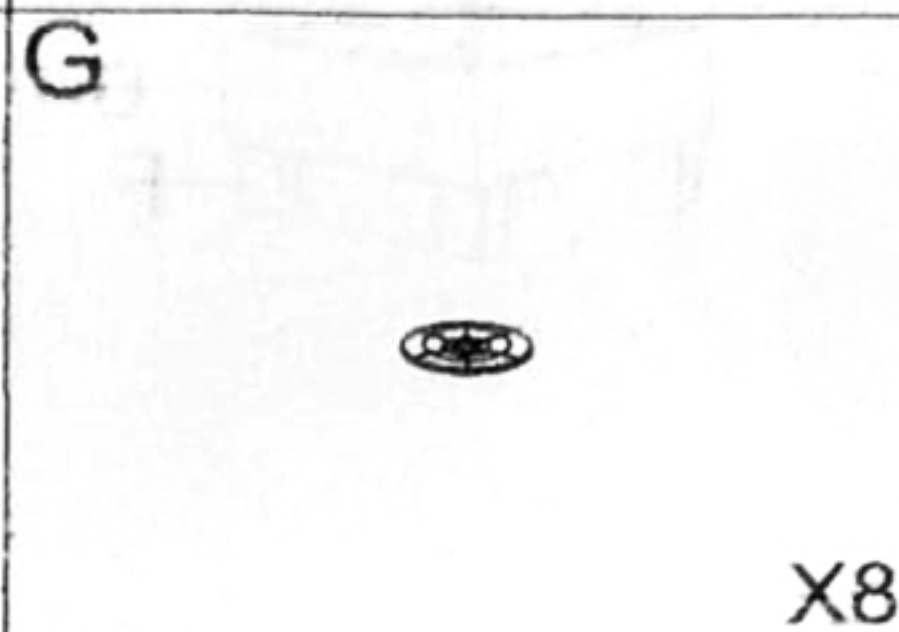
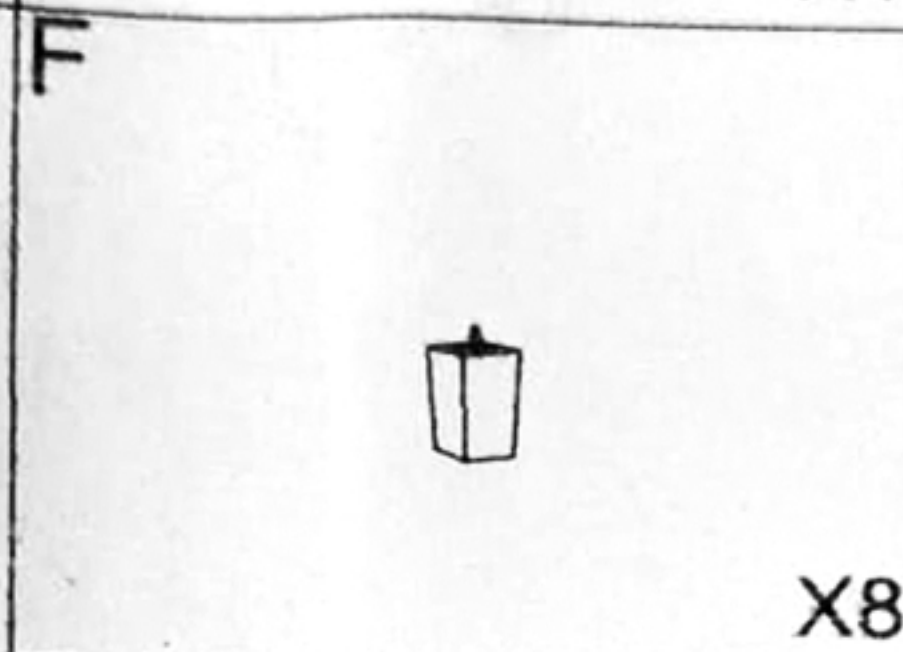
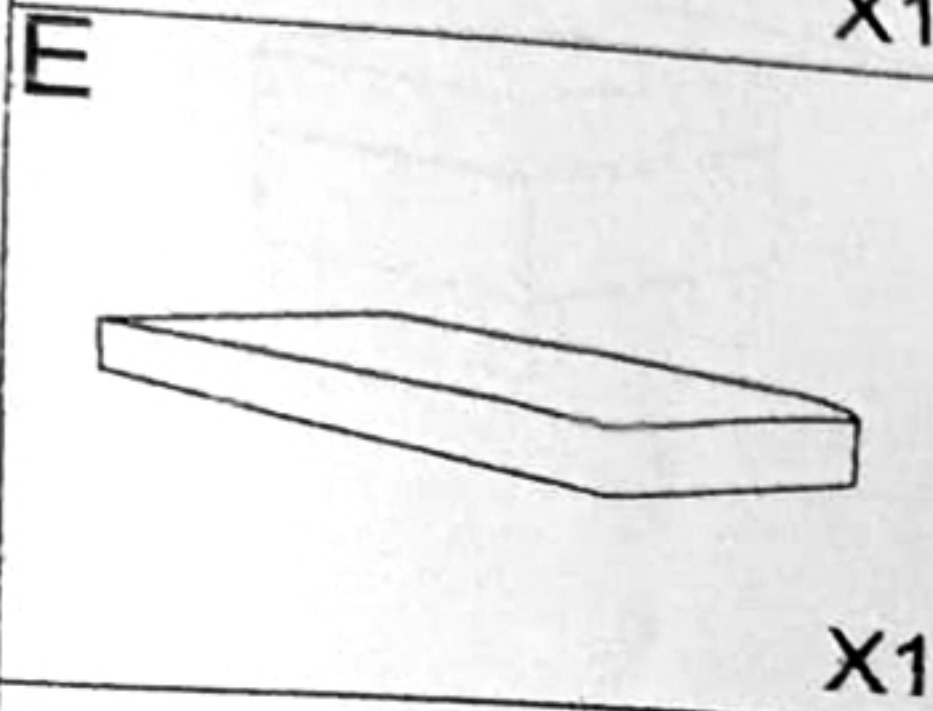
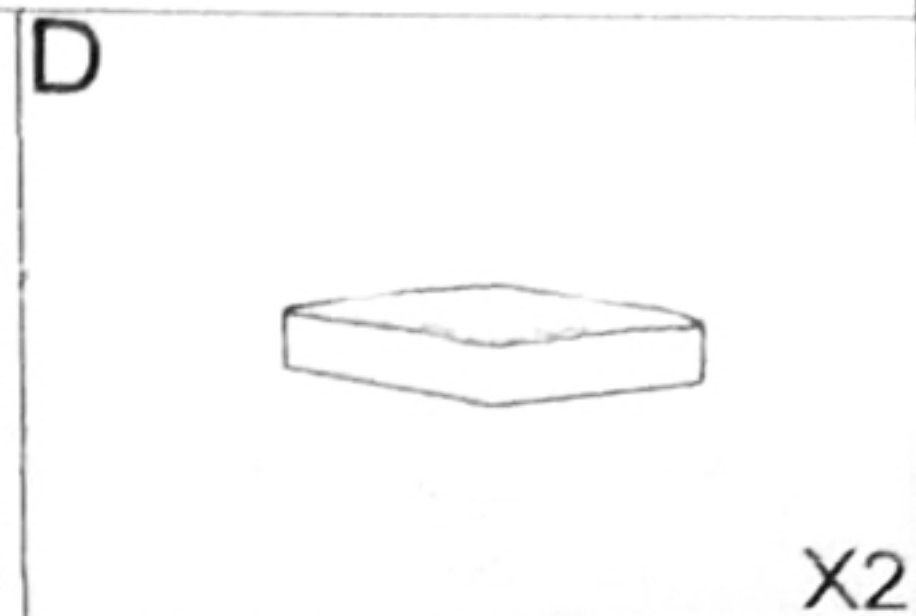
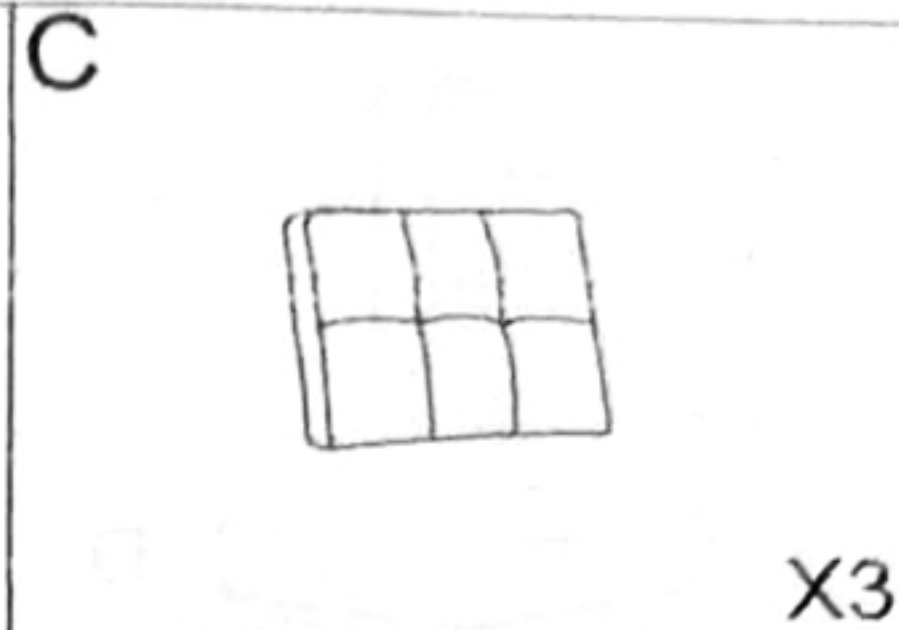
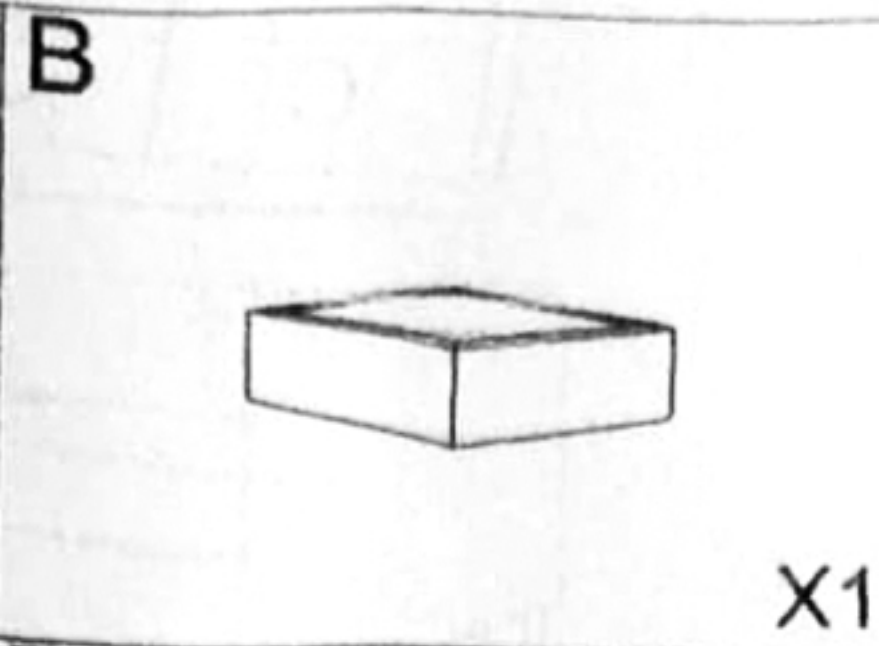
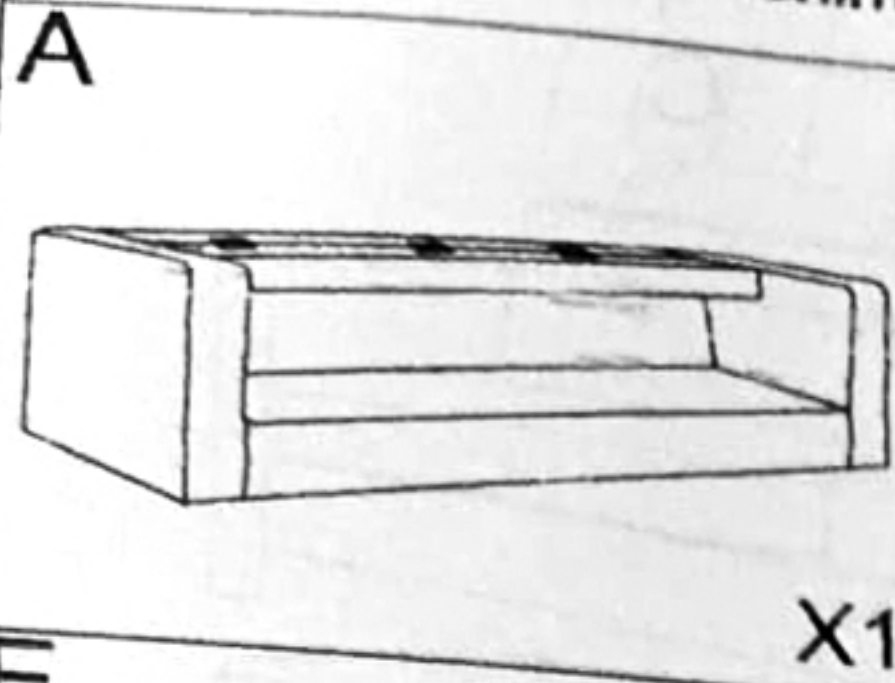

Step 1:

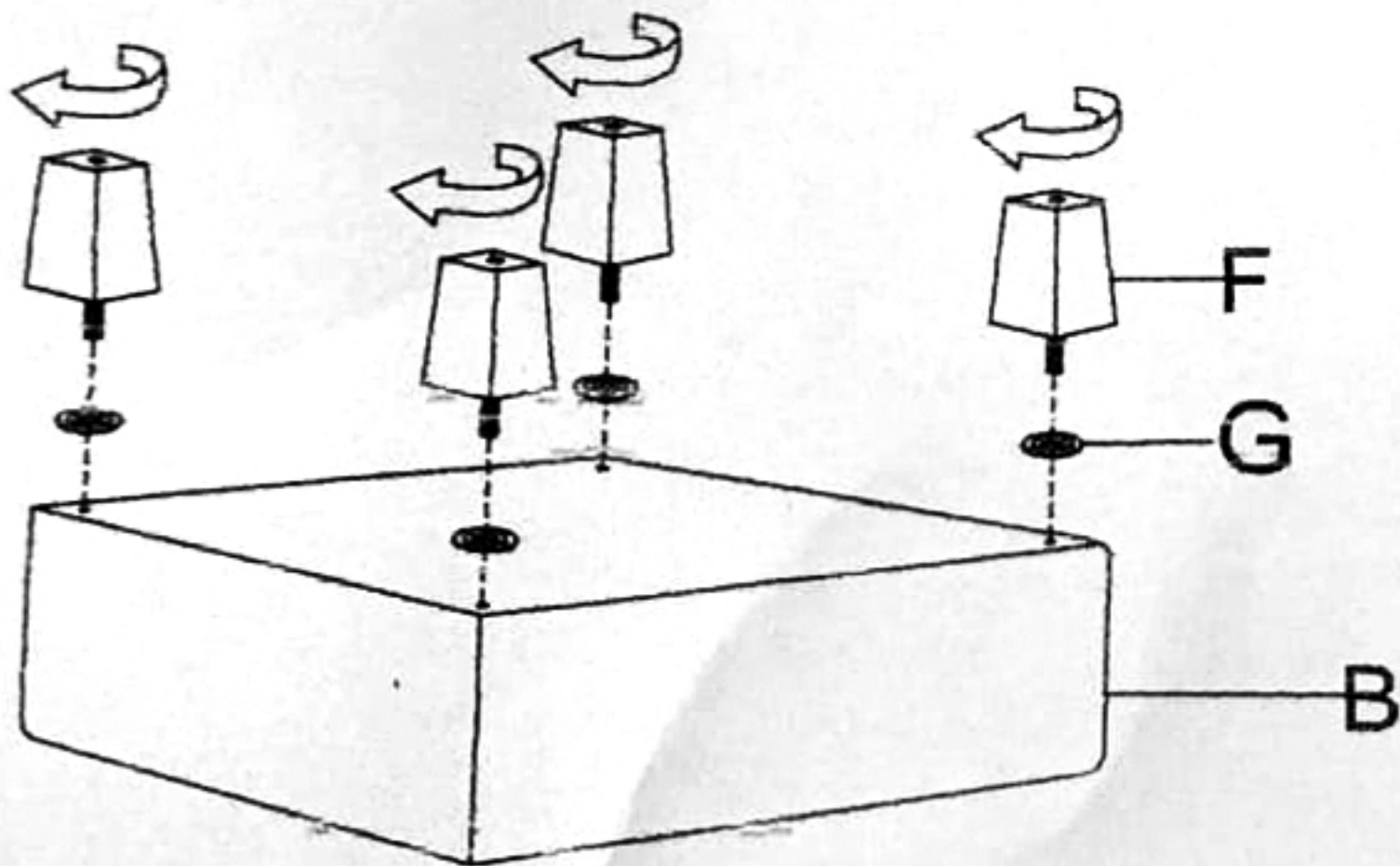

Step 2:

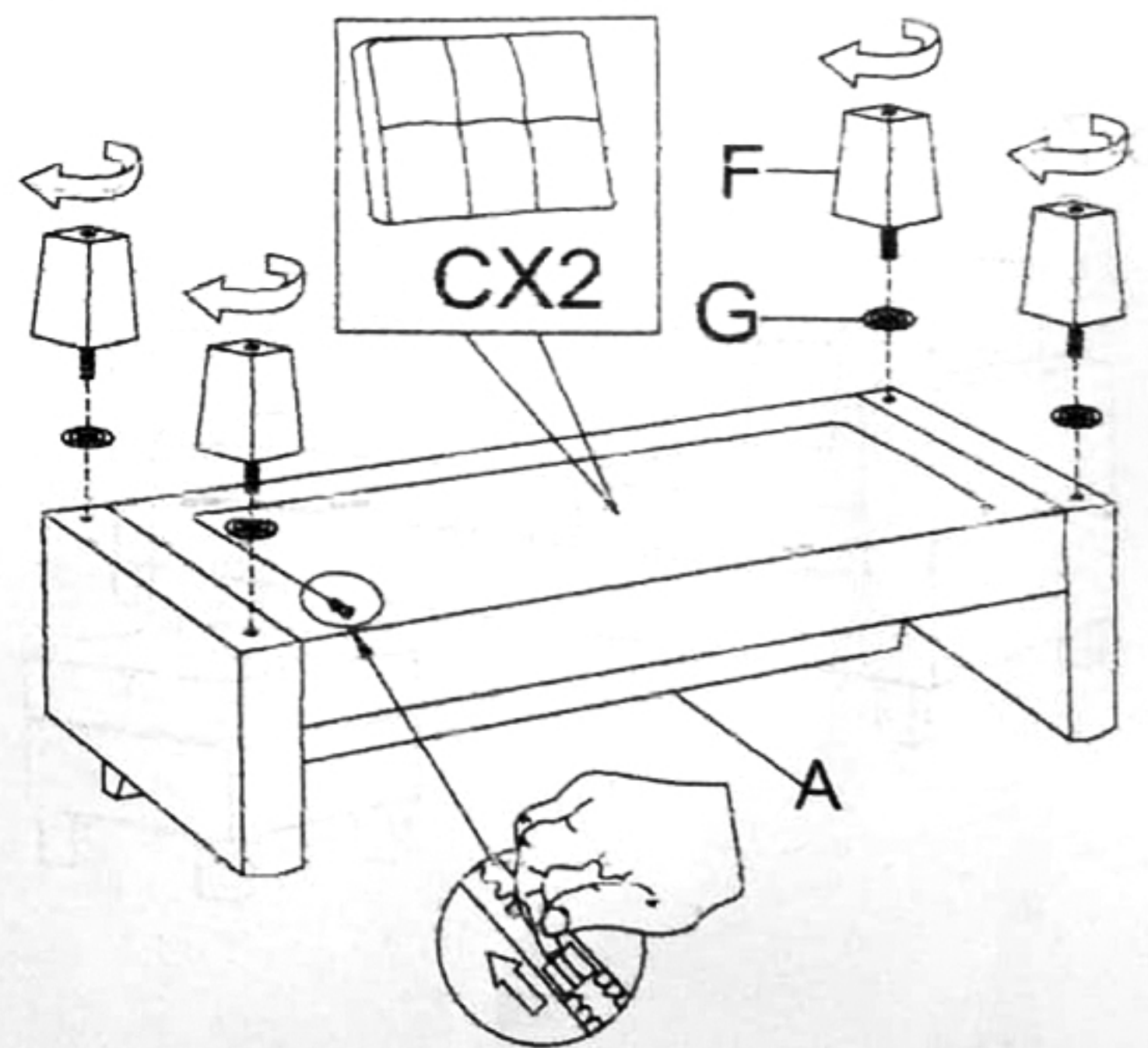

Step 3:

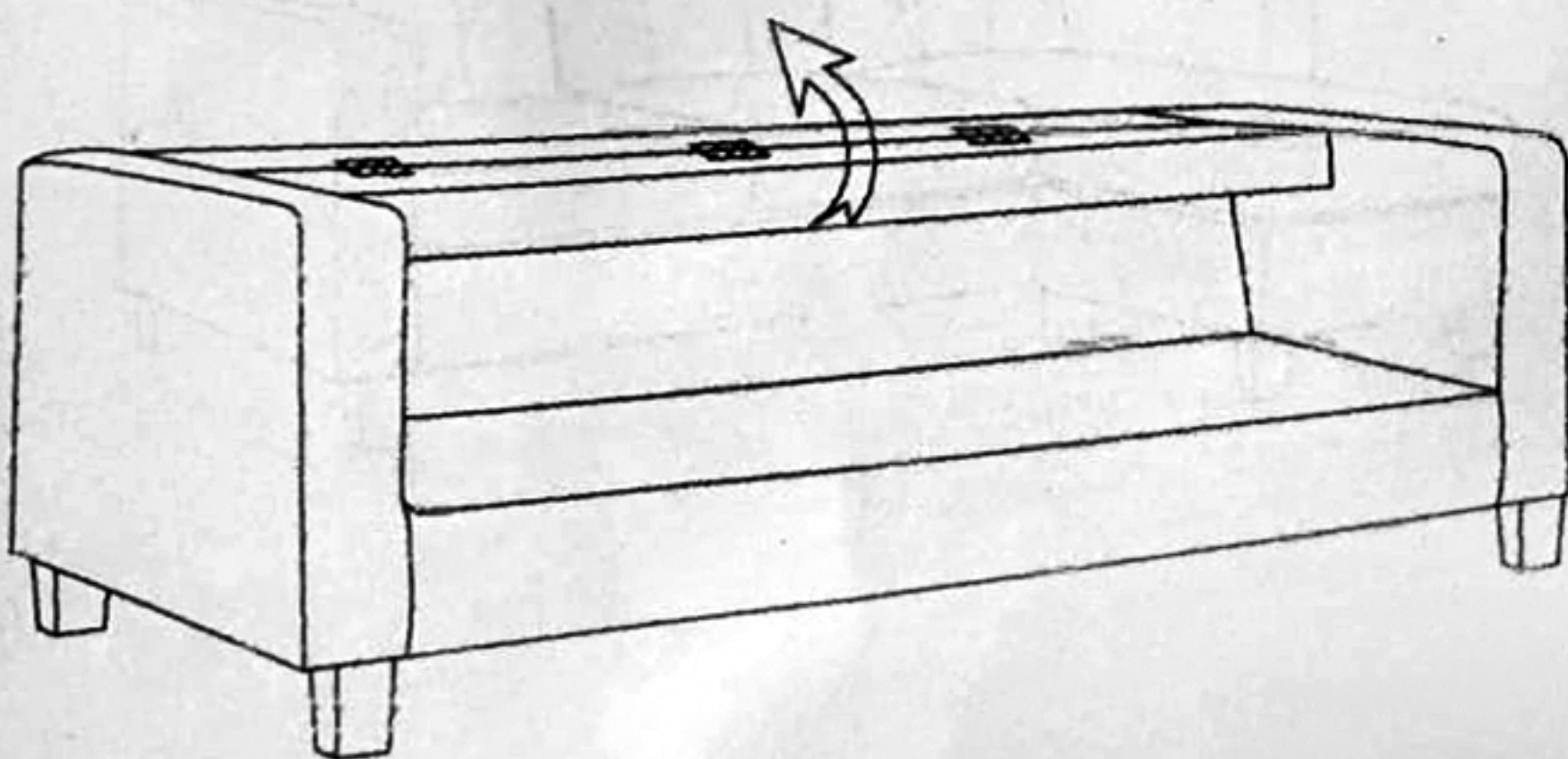

Step 4:

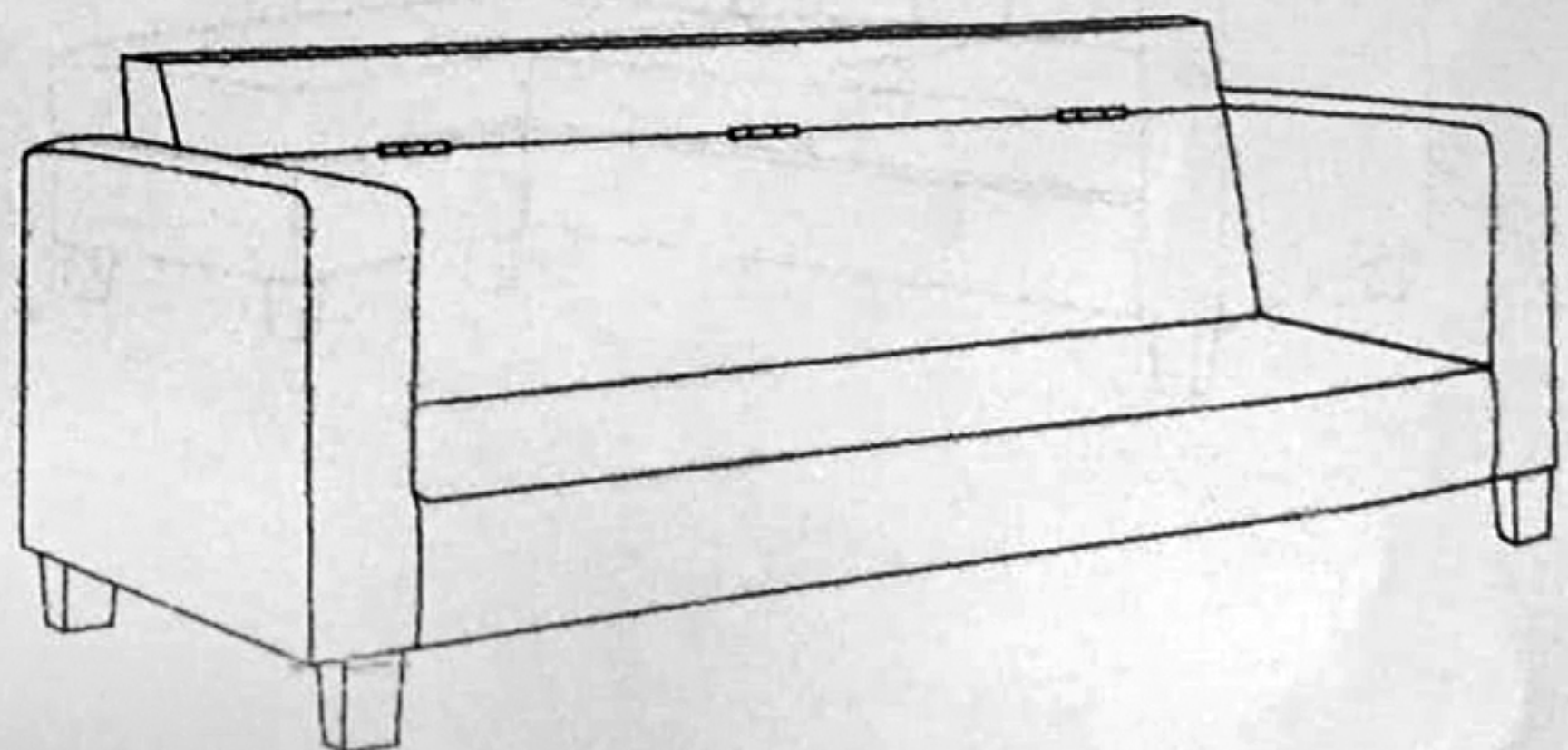

ASSEMBLY INSTRUCTION

Step 5:

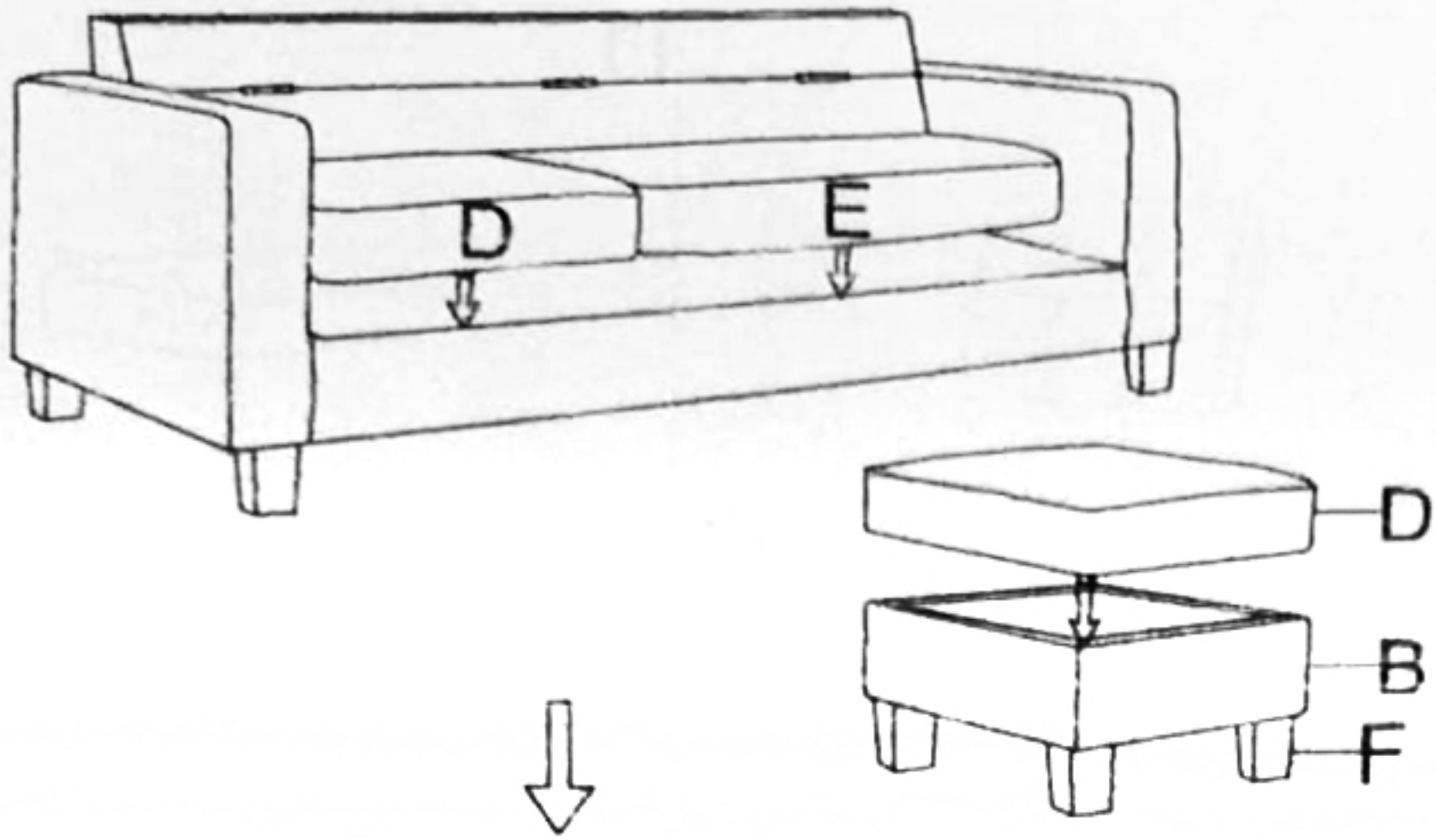

Step 6

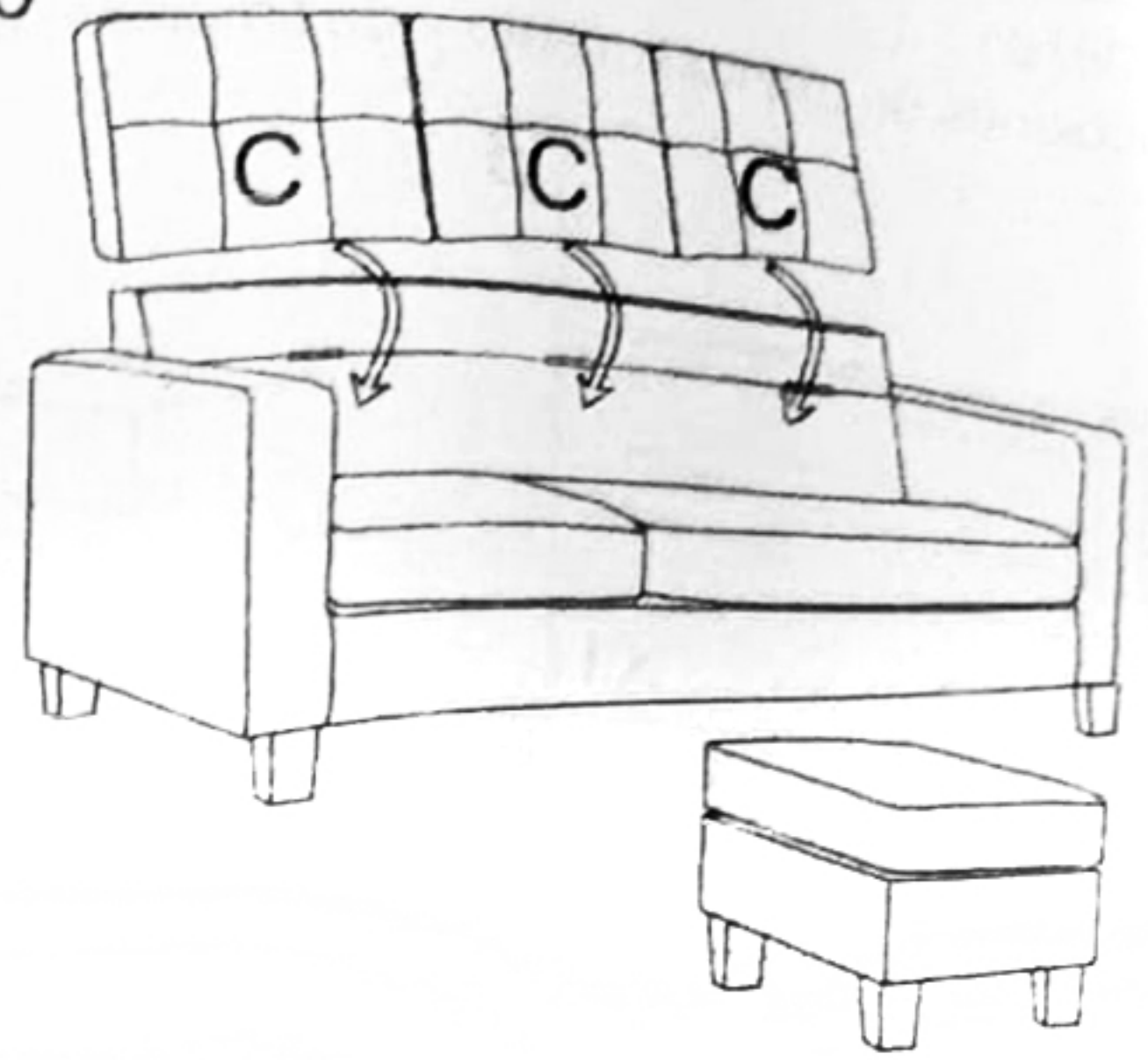

Step 7:

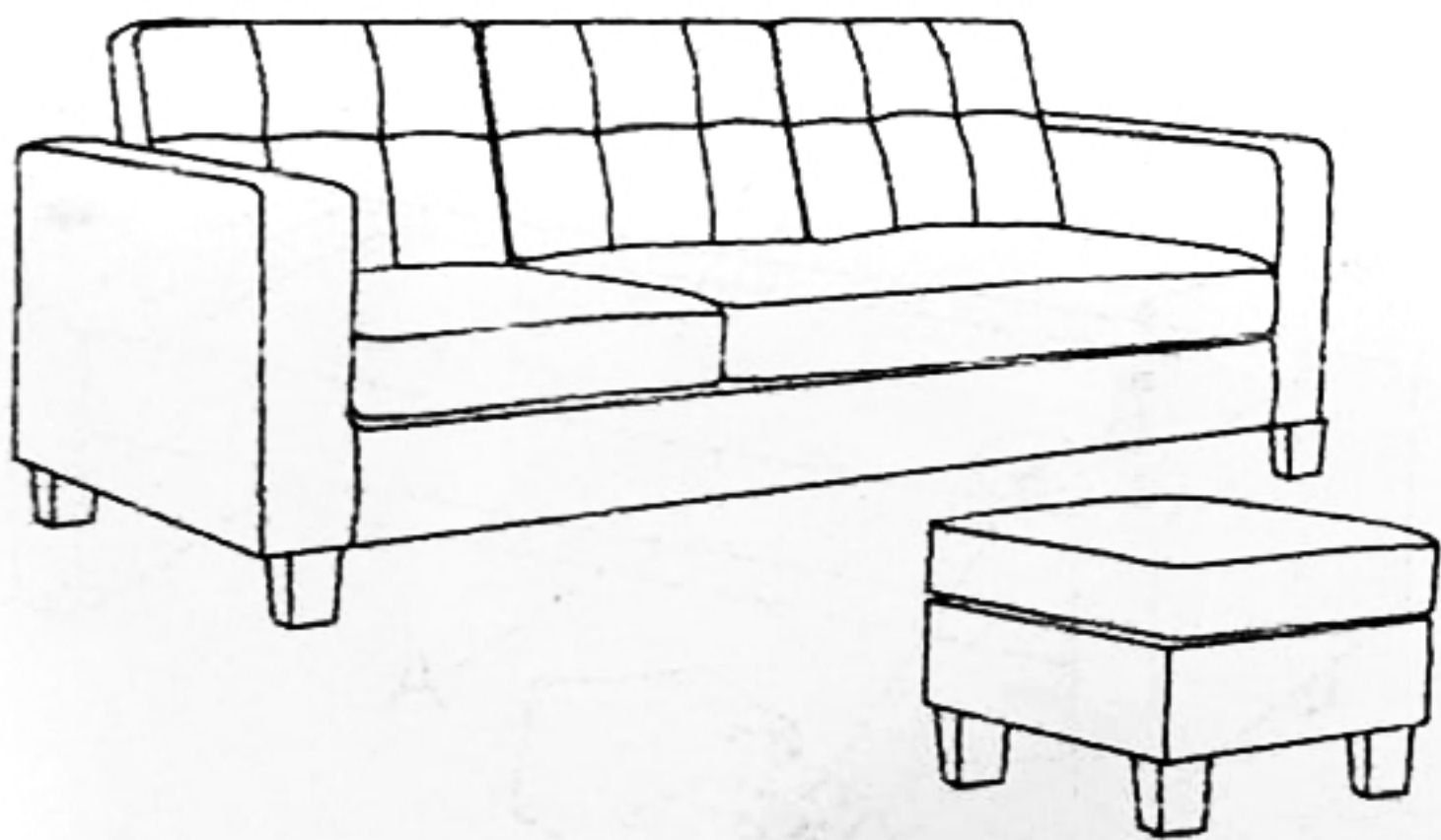

OR

