

Datos del importador R/ España C/ Industrias 2, Alcorcón G79508701
 Instrucciones de mantenimiento y de limpieza; aplicar productos de limpieza en seco y guardar en un lugar seco.

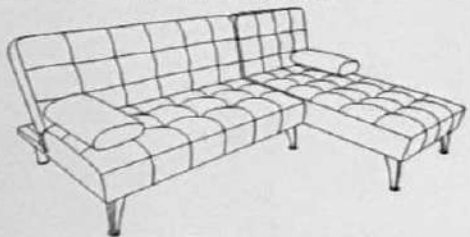



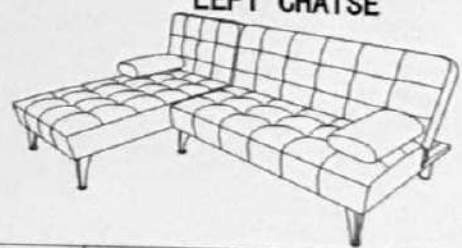

ASSEMBLY INSTRUCTION

RIGHT CHAISE

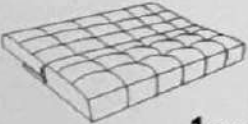
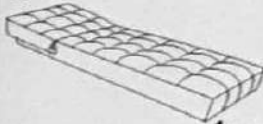

LEFT CHAISE



| | | | | | | |
|---|--|---|---|---|--|--|
| A  1pc | B  1pc | C  2pcs | D  4pcs | E  4pcs | F  12pcs | G  12pcs |
|---|--|---|---|---|--|--|

Step 1:

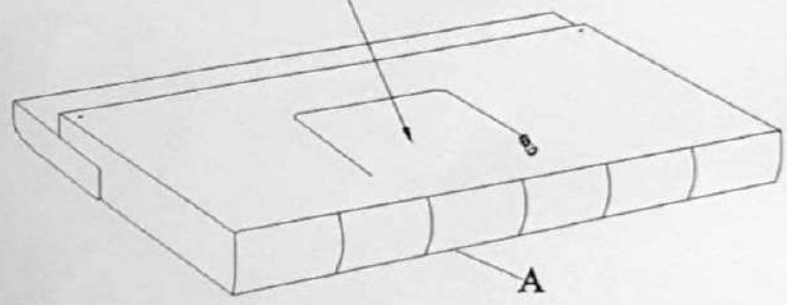
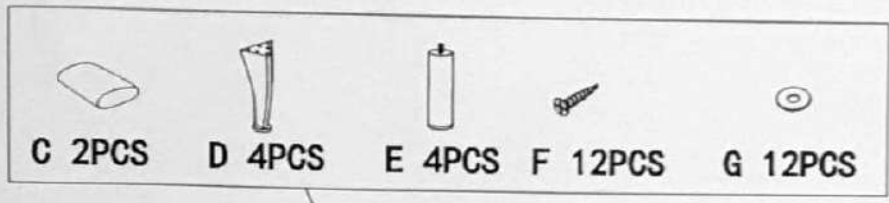

Step 2:

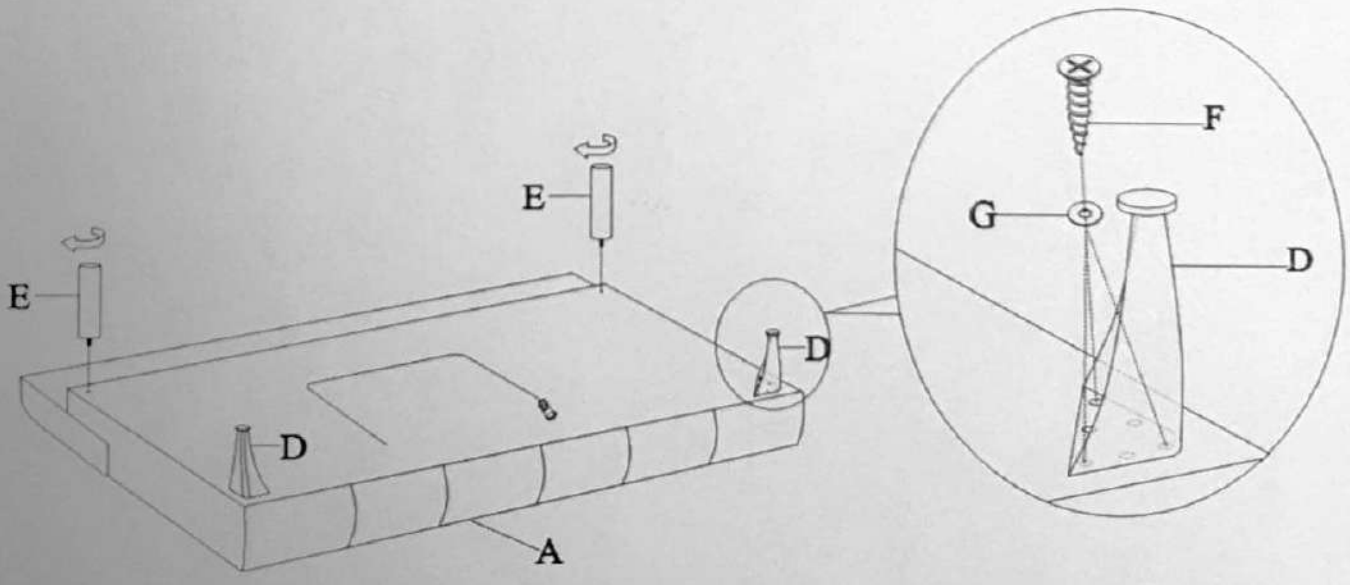

Step 3:

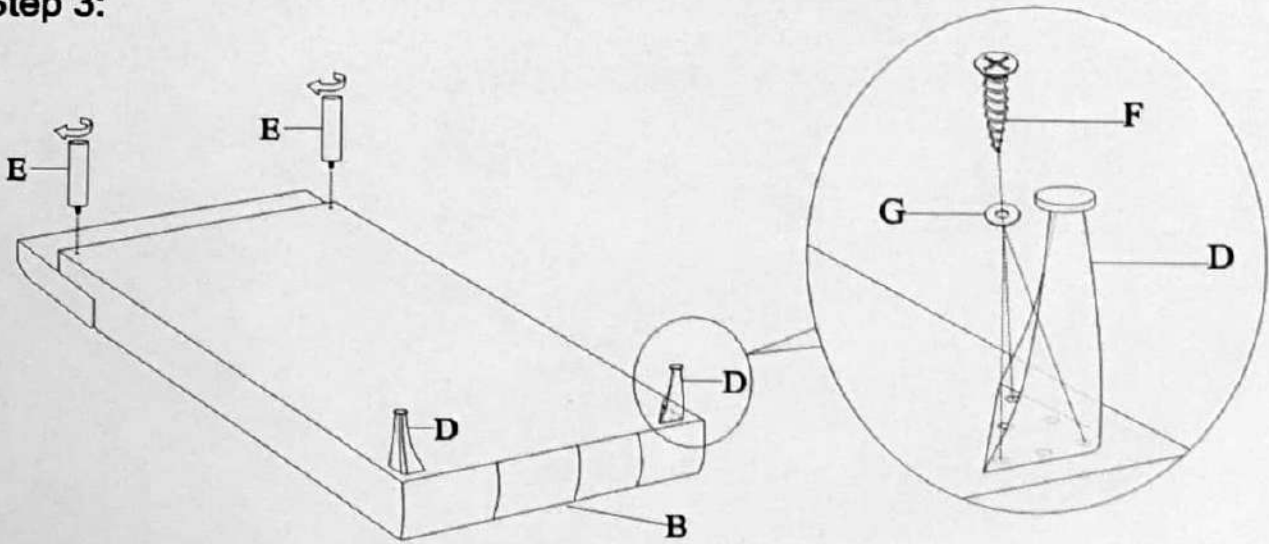

Step 4:

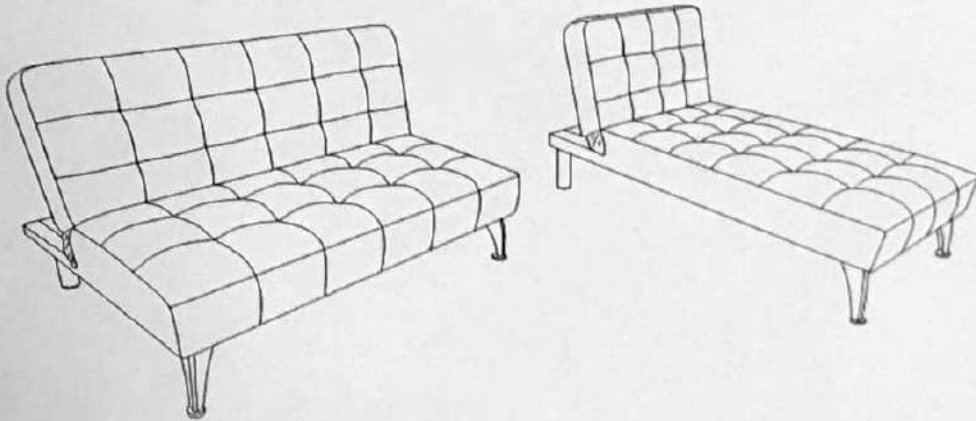

Step 5:

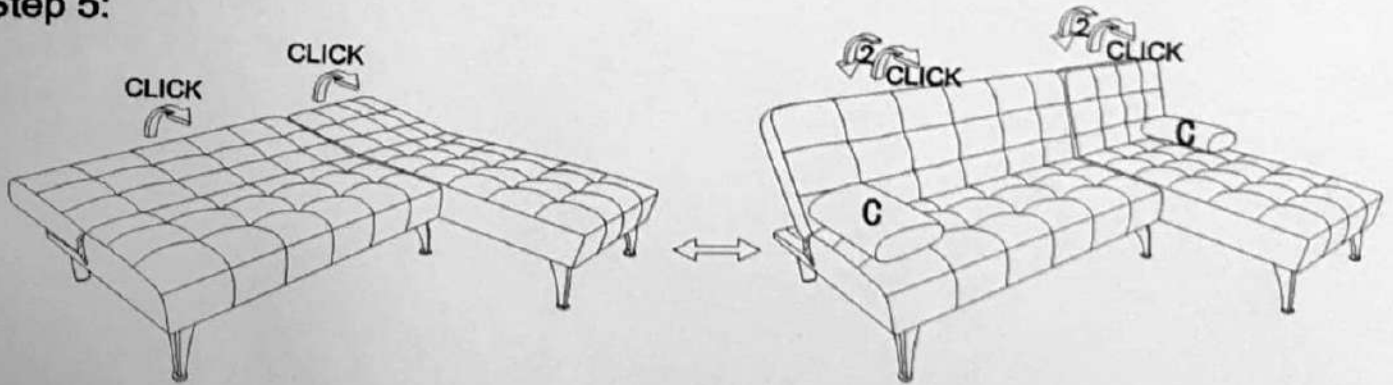

OR

