

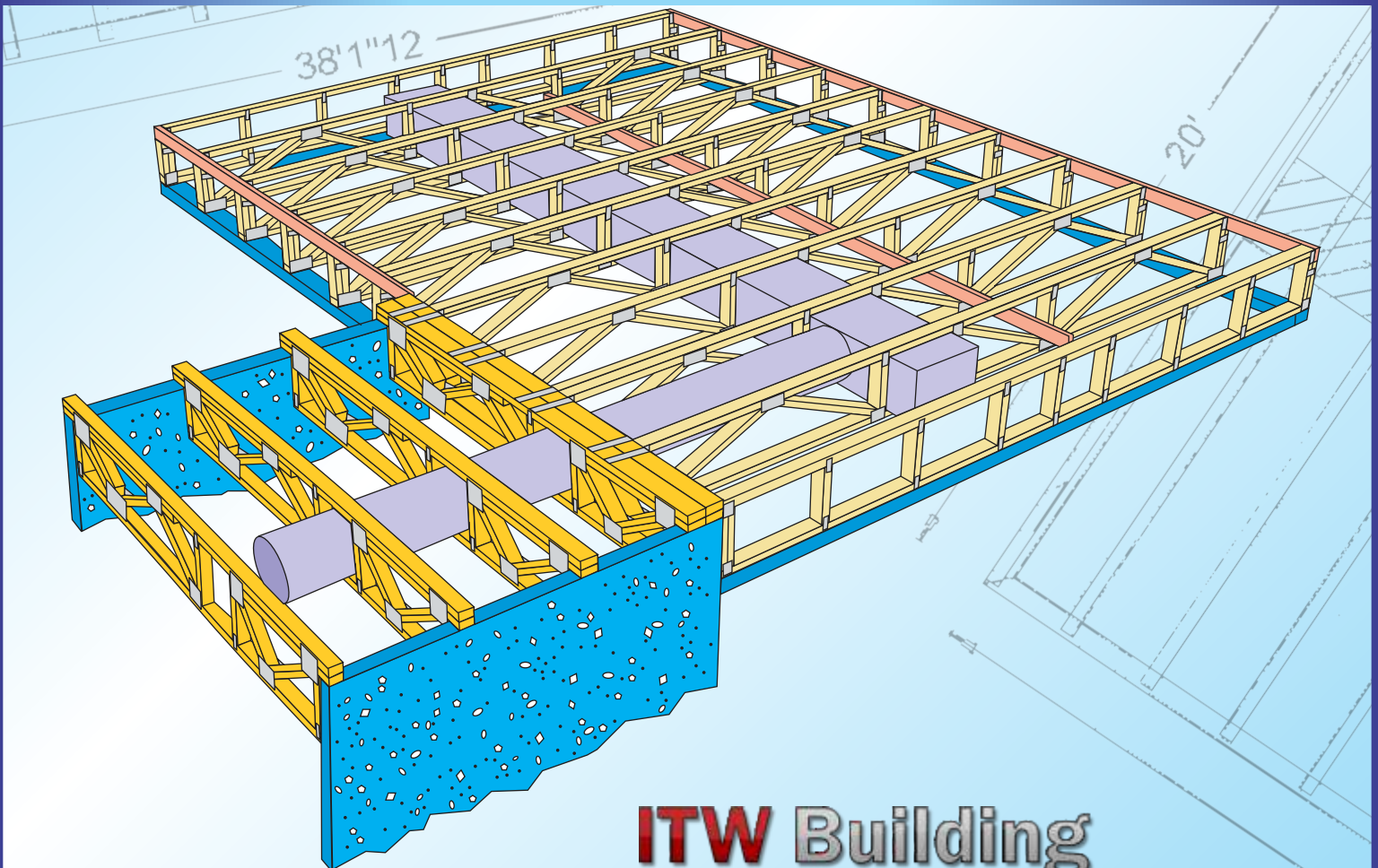

Get more Quality, Flexibility and Labor Savings using

FLOOR TRUSSES



ITW Building Components Group
BUILDING SYNERGY



Wood Floor Trusses are Environmentally Compatible.



Get more Quality, Flexibility and Labor Savings using **FLOOR TRUSSES**



Builders want solutions that help them stay on schedule and maintain quality construction and profits. When compared to traditional joist construction, manufactured wood floor truss systems are better, stronger, and can be installed faster. A manufactured truss is an engineered structural component assembled from wood members, metal connector plates and other mechanical fasteners. The truss members form a rigid structural framework and are assembled such that the members form triangles. Most builders are familiar with roof truss systems, but may not realize the advantages of a manufactured floor truss system.

The benefits of manufactured wood truss floor systems are many. Floor trusses can span great distances, creating larger open spaces below unobstructed by columns and partitions. Truss systems are quicker and easier to install than traditional floor joists, and because they're manufactured in controlled environments, there's less chance of warping, shrinking, and twisting of lumber. Manufactured floor truss systems also save timber resources by reducing the amount of wood waste generated during construction.



The component manufacturing process is simple and offers the professional builder plenty of time- and cost-saving resources along the way. Here's how it works:

House plans are sent by the builder to the wood floor truss manufacturer. There are hundreds of truss manufacturers operating nationwide, but builders should research the quality and delivery costs before choosing a vendor.

The building designer determines what loads need to be supported within the home. Then the truss designer determines how many trusses will be required, and their specific placement in the home. The manufacturer then builds the trusses, labels them for accurate installation, and ships them to the builder on the jobsite.

A detailed diagram with the placements of the trusses is sent along with the order to help the builder place the trusses exactly where they should be installed.

Once the trusses are on the site, the builder can really start to see the benefits. The consistent size and height of the manufactured floor joist will mean easier sub-floor material installation, and the open web design allows for utilities to be run through in the floor system without drilling or cutting holes. These benefits will reduce the amount of time trade contractors spend on site, speed up construction, and ultimately save the builder money. The technology used in the design and manufacturing of floor trusses makes them a superior choice for builders looking to streamline construction and provide a higher quality home to their customers.





The Benefits of FLOOR TRUSSES



Floor trusses are delivered to your site, ready for installation. No cutting or fitting is required. Strong, lightweight and rigid "System 42" Floor Trusses go up easily and quickly. Often without the use of a crane. Expensive steelworkers, welders or riggers are not required. Your crew can do it all.

Decking and ceiling materials are attached directly to trusses without need for special hardware. And because System 42 trusses can be spaced wider apart, less trusses are required resulting in less nails to drive.

Mechanicals are installed quickly through the open webs without notching or furring. Electricians, A/C contractors and plumbers are off the job quicker.

System 42 provides longer clear spans providing exceptional design flexibility. For this reason, plus their cost saving benefits during construction, more and more architects are specifying System 42 Floor Trusses than ever before.



Two of the most common web patterns for floor trusses:

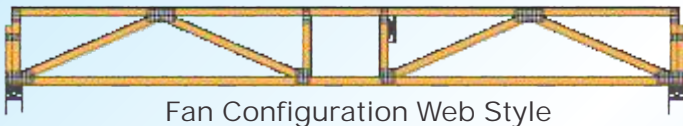

Floor truss are built with open chases for ductwork and have natural open spaces for plumbing and electrical wiring. Floor truss systems are sometimes called System 42's, because to build them manufacturers turn the 2x4's on their side. This allows for shallow depths as well as a 3 1/2" nailing surface. Some floors are built from 2x3's, others from 2x4's. Floor trusses can be manufactured with many different possible end conditions to accommodate different installation needs; around raised walls, pocketed beams, headers around stairways, etc.

Is it OK to move a floor truss? Typical floor trusses are engineered to be spaced evenly, and the truss design drawing will tell you how the design spacing. Occasionally the need will arise to shift one of the floor trusses from where it was designed to be. When this happens, please contact the truss manufacturer to be sure it works. Sliding a floor truss even a few inches puts more load on the truss you're moving it away from, as shown in the drawing below.

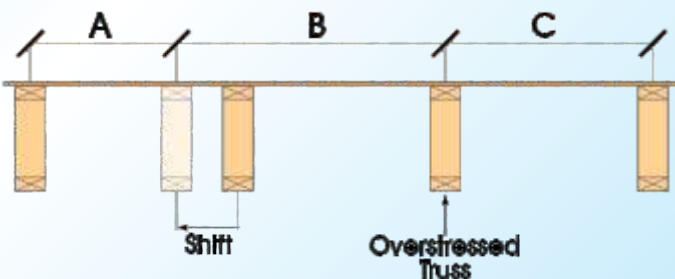

		<i>If you shift it:</i>	<i>Then overstressed truss carries:</i>	<i>B</i>
24" on center trusses	3"	6.2% more load than designed for	27"	
	6"	12.5% "	30"	
	9"	18.7% "	33"	
16" on center	3"	9.3% more load than designed for	19"	
	6"	18.7% "	22"	

Check with the truss manufacturer before shifting a truss !



Framing with FLOOR TRUSSES

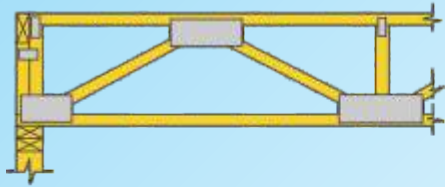

Bottom chord bearing on a stud wall.

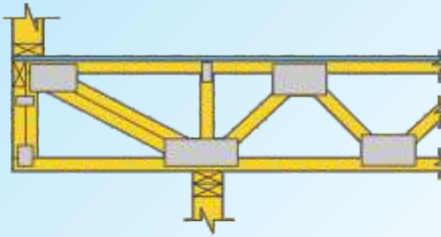

Cantilever with an exterior wall on the end.

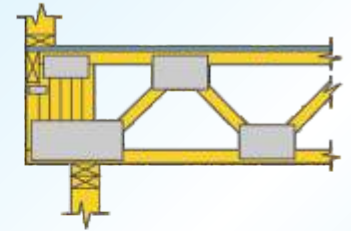

Bottom chord bearing with short cantilever and exterior wall.

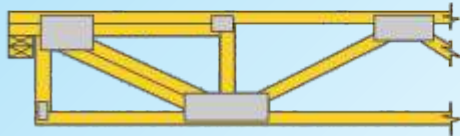

Top chord bearing on stud wall.

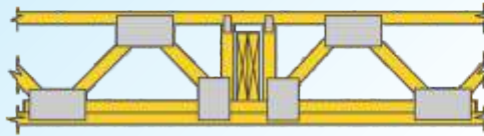

Floor truss designed to carry an interior header.

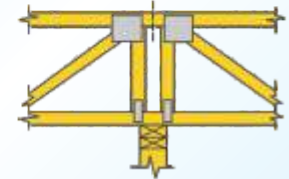

Interior bearing on wall

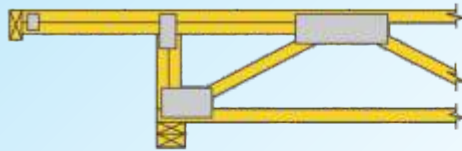

Overhang on a floor truss used on a roof.

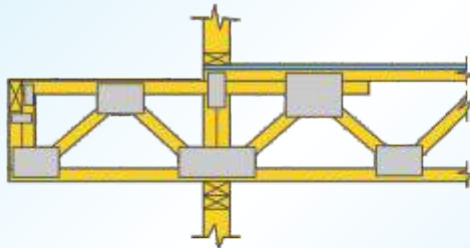

Dropped cantilever for use on exterior balconies.

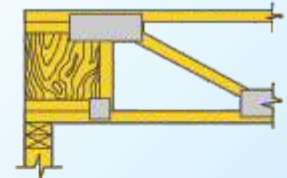

Trimable end condition with I-joist insert.

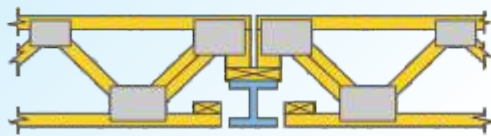

Interior top chord bearing with a variable end height.

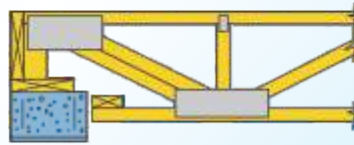

Top chord bearing with a variable end height.

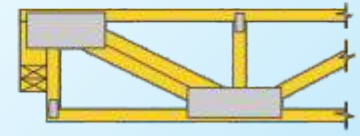

Top chord bearing on stud wall with variable end height.

Multiple ply floor trusses may require special connection details between plies. Special connectors will be specified on the design.

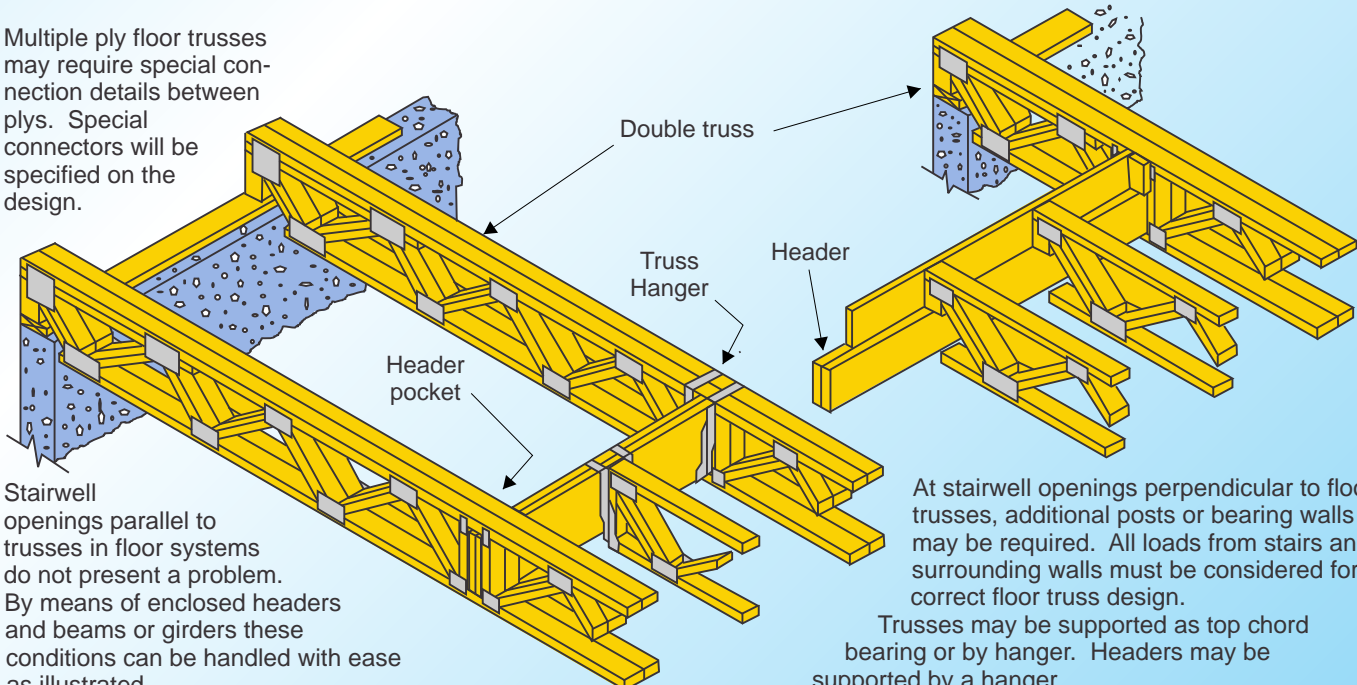

Stairwell openings parallel to trusses in floor systems do not present a problem. By means of enclosed headers and beams or girders these conditions can be handled with ease as illustrated.

At stairwell openings perpendicular to floor trusses, additional posts or bearing walls may be required. All loads from stairs and surrounding walls must be considered for correct floor truss design.

Trusses may be supported as top chord bearing or by hanger. Headers may be supported by a hanger.



These allowable spans are based on NDS 2005. Maximum deflection is limited by L/360 or L/480¹ under live load. Basic Lumber Design Values are $F_{(b)}$ =2000 psi $F_{(t)}$ =1100 psi $F_{(c)}$ =2000 psi E =1,800,000 psi Duration Of Load = 1.00. Spacing of trusses are center-to-center (in inches).

Top Chord Dead Load = 10 psf. Bottom Chord Dead Load = 5 psf. Center Line Chase = 24" max. Trusses must be designed for any special loading, such as concentrated loads. Other floor and roof loading conditions and a variety of species and other lumber grades are available.

4x2 Lumber

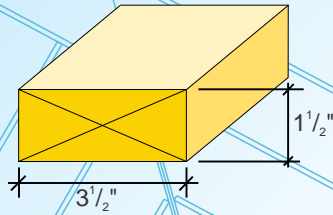

3x2 Lumber

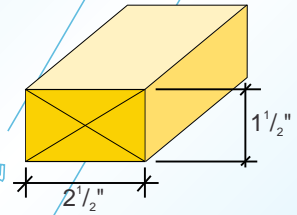

Center Spacing	Deflection Limit	40 PSF Live Load 55 PSF Total Load					
		12"	14"	16"	18"	20"	22"
16" o.c.	L/360	22'2"	24'11"	26'10"	28'8"	30'4"	31'11"
	L/480	20'2"	22'7"	24'11"	27'2"	29'4"	31'5"
19.2" o.c.	L/360	20'9"	22'8"	24'4"	26'0"	27'6"	29'0"
	L/480	18'11"	21'3"	23'6"	25'7"	27'6"	29'0"
24" o.c.	L/360	18'5"	20'1"	21'7"	23'1"	24'5"	25'9"
	L/480	17'7"	19'9"	21'7"	23'1"	24'5"	25'9"

40 PSF Live Load 55 PSF Total Load						
12"	14"	16"	18"	20"	22"	Truss Depth
19'0"	20'9"	22'4"	23'10"	25'3"	26'7"	16"
18'0"	20'2"	22'4"	23'10"	25'3"	26'7"	18"
17'3"	18'9"	20'3"	21'7"	22'10"	24'1"	20"
16'11"	18'9"	20'3"	21'7"	22'10"	24'1"	22"
15'2"	16'7"	17'10"	19'1"	20'2"	21'3"	16"
15'2"	16'7"	17'10"	19'1"	20'2"	21'3"	18"

Center Spacing	Deflection Limit	60 PSF Live Load 75 PSF Total Load					
		12"	14"	16"	18"	20"	22"
16" o.c.	L/360	19'4"	21'4"	23'0"	24'6"	26'0"	27'4"
	L/480	17'7"	19'9"	21'10"	23'9"	25'8"	27'4"
19.2" o.c.	L/360	17'9"	19'4"	20'10"	22'3"	23'7"	24'10"
	L/480	16'7"	18'7"	20'6"	22'3"	23'7"	24'10"
24" o.c.	L/360	15'9"	17'2"	18'6"	19'9"	20'11"	22'0"
	L/480	15'4"	17'2"	18'6"	19'9"	20'11"	22'0"

60 PSF Live Load 75 PSF Total Load						
12"	14"	16"	18"	20"	22"	Truss Depth
16'3"	17'9"	19'2"	20'5"	21'8"	22'9"	16"
15'9"	17'8"	19'2"	20'5"	21'8"	22'9"	18"
14'9"	16'1"	17'4"	18'6"	19'7"	20'7"	20"
14'9"	16'1"	17'4"	18'6"	19'7"	20'7"	22"
13'0"	14'2"	15'3"	16'4"	17'3"	18'2"	16"
13'0"	14'2"	15'3"	16'4"	17'3"	18'2"	18"

Center Spacing	Deflection Limit	85 PSF Live Load 100 PSF Total Load					
		12"	14"	16"	18"	20"	22"
16" o.c.	L/360	16'11"	18'6"	19'11"	21'3"	22'6"	23'8"
	L/480	15'8"	17'7"	19'5"	21'2"	22'6"	23'8"
19.2" o.c.	L/360	15'4"	16'9"	18'1"	19'3"	20'5"	21'6"
	L/480	14'9"	16'6"	18'1"	19'3"	20'5"	21'6"
24" o.c.	L/360	13'8"	14'10"	16'0"	17'1"	18'1"	19'1"
	L/480	13'8"	14'10"	16'0"	17'1"	18'1"	19'1"

85 PSF Live Load 100 PSF Total Load						
12"	14"	16"	18"	20"	22"	Truss Depth
14'1"	15'5"	16'7"	17'8"	18'9"	19'9"	16"
14'0"	15'5"	16'7"	17'8"	18'9"	19'9"	18"
12'9"	13'11"	15'0"	16'0"	16'11"	17'10"	20"
12'9"	13'11"	15'0"	16'0"	16'11"	17'10"	22"
11'3"	12'3"	13'3"	14'1"	14'11"	15'9"	16"
11'3"	12'3"	13'3"	14'1"	14'11"	15'9"	18"

(1) Vibration Control -- Research by Virginia Tech indicates that L/480 live load deflection criteria provides a high degree of resistance to floor vibration (bounce). The building designer

desiring this benefit may choose to specify an L/480 live load deflection criteria to be used for the floor trusses.



Duct Openings For Fan Style Floor Trusses With 4x2 Chords & Webs

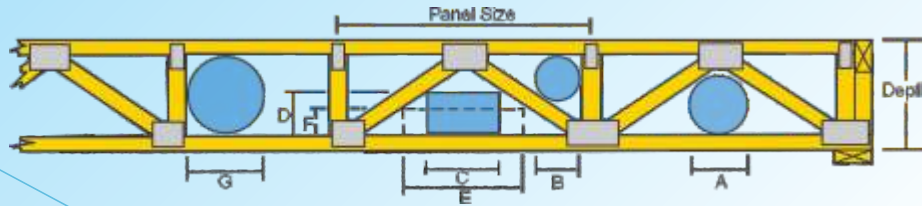

Typical Duct Opening Sizes For 4x2 Fan Style Floor Trusses

Depth	Panel Size	A	B	C	D	E	F	G
10	60	4 ¹ / ₂	4 ¹ / ₄	11	4 ¹ / ₂	16	4	7
11	60	5 ¹ / ₄	5 ¹ / ₄	12	5 ¹ / ₂	15	5	8
11 ⁷ / ₈	60	7 ³ / ₄	6 ³ / ₄	10	6 ¹ / ₄	14	5 ¹ / ₂	8 ³ / ₄
12	60	6 ¹ / ₄	6 ¹ / ₄	14	6	20	5	9
13	60	7 ¹ / ₄	7 ¹ / ₄	12	7	18 ¹ / ₂	6	10
14	60	8 ¹ / ₄	8 ¹ / ₄	17	7	22	6	11
15	60	9 ¹ / ₄	8 ¹ / ₂	15	8	25	6	12
16	60	10 ¹ / ₄	9 ¹ / ₂	14	9	27	6	13
18	60	12 ¹ / ₄	10 ¹ / ₂	14 ¹ / ₂	10 ¹ / ₂	26	7	15
20	60	14	11 ¹ / ₂	14 ¹ / ₂	12	26	8	17
22	60	16	12 ¹ / ₂	15	13	30	8	19
24	60	18	13 ¹ / ₂	16	14	32	8	21
26	60	19	14 ¹ / ₂	18	15	34	8	23
30	60	22	16	20	17	32	10	24
36	60	25	17 ¹ / ₂	22	19 ¹ / ₂	36	10	24

All Dimensions In Inches

Duct Openings For Warren Style Low Joists

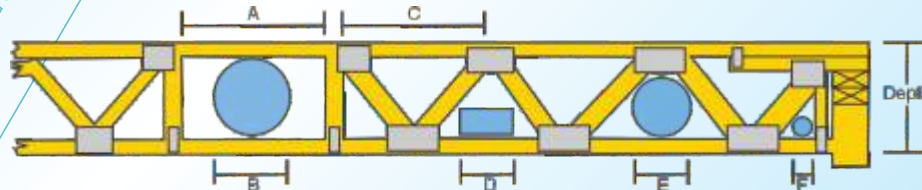

Depth	A	B	C	D	E	F
10	18	7	24	4x6	5	41/2
12	20	9	30	5x9	7	53/4
13	20	10	30	5x11	8	6
14	24	11	30	6x10	8 ¹ / ₂	6 ¹ / ₂
15	24	12	30	6x12	9 ¹ / ₂	7
16	24	13	30	6x13	10	7 ¹ / ₂
17	24	14	30	6x14	10 ¹ / ₂	7 ¹ / ₂
18	24	15	30	7x13	11	8
19	24	16	30	7x14	11 ¹ / ₂	8 ³ / ₄
20	24	17	30	7x15	12	8 ¹ / ₂
21	24	18	30	8x14	12 ¹ / ₂	9
22	24	19	30	8x15	13	9
24	24	21	30	8x16	14	9 ¹ / ₄

All Dimensions In Inches



Typical Bearing / Heel Conditions for FLOOR TRUSSES



Layout, Design and Engineering Software

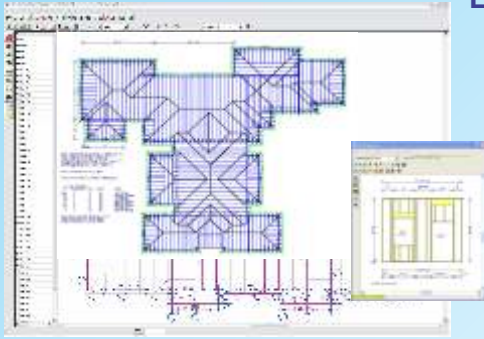

Powerful CAD-based design software from ITW Building Components Group generates traditional plan view layouts, and 3-D graphics that give an accurate picture of a structure from virtually any perspective by showing every component in place. ITW's *Instinct Residential Design System* is cutting edge technology utilizing a BIM-driven system that integrates information and functions through a single 3-D model that can be shared by the entire supply chain.

ITW Building Components Group

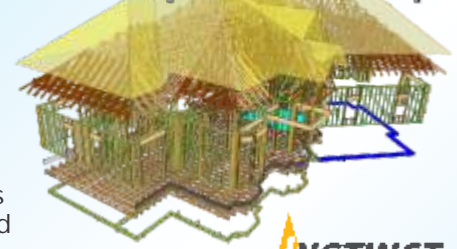

Bracing is extremely IMPORTANT!! Every truss system needs adequate bracing. The purpose of most bracing is to ensure that the trusses and truss members remain straight and do not bow out of their plane. Inadequate, improper or incorrectly installed bracing can lead to collapses, failures and serious accidents. An engineered bracing system will avoid these pitfalls and ensure the structural integrity of the truss system. Trusses need to be braced during installation, which is called temporary bracing and they need permanent bracing which will remain installed for the life of the roof system.

Temporary Bracing Guidelines: For metal plate connected wood truss systems, refer to BCSI 1-06 for proper installation bracing guidelines.

The provider of this document and ITW Building Components Group Inc., nor any of its divisions or companies, does not warrant the recommendations and information contained herein as proper under all conditions and expressly disclaims any responsibility for damages arising from the use, application, or reliance on the recommendations contained herein.

Sound Transmission

Sound Control

Ratings of floor-ceiling assemblies are determined by two methods. The Impact Insulation Class (IIC) is measured in accordance with ASTM Standard E-492. Airborne noise Sound Transmission Class (STC) is measured in accordance with ASTM Standard E-90.

Impact Noise

The IIC listing for floor-ceiling assemblies are generally shown for bare floors and for floors with carpet and pad. Although any carpet, with or without pad, will improve the IIC, a heavy wool carpet over a good quality pad will make a significant improvement. According to most tests, the addition of a 44 oz. Carpet over a 40 oz hair felt pad increases the IIC from 38 to 63.

Airborne Noise

ASTM Standard E-413 is used to determine the sound transmission class, STC. Some values listed for assemblies tested in 1970 or before were done under a different standard, however, the resulting STC will generally fall in the same range. Airborne sound control is most effective when air leaks and flanking paths in the assemblies are closed off. Assemblies should be airtight. Recessed fixtures should not be back-to-back in the same cavity. ASTM Recommended Practice E-497 provides good guidance for sound control.

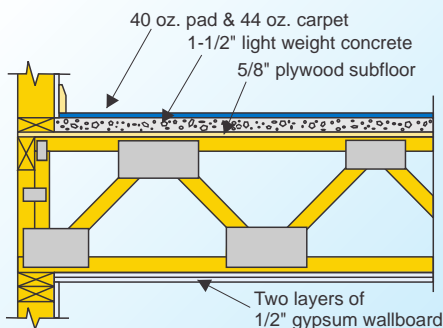

Sound Transmission Class STC=46
Impact Insulation Class IIC=72
Intest No. 5-425-1

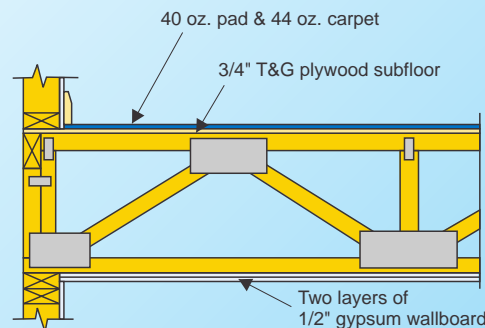

Sound Transmission Class STC=47
Impact Insulation Class IIC=72
Intest No. 5-425-3



Performance Facts using

FLOOR TRUSS SYSTEMS



- Faster Construction / Saves Money
- Longer Clear Spans
- Hides Mechanicals
- Spaced 24" oc., multiple depths
- Cantilever and Balcony Built In
- 3.5 Width Surface to Glue and Nail to
- Cold Air Returns can be Eliminated
- Reduce Field Material Losses
- Pick-up Interior Point Loads
- Custom Designed for your project
- Commercial & Residential Applications
- Trim-able ends for concrete mis-pours
- No Humps in Floors
- Sound and Fire Ratings
- Angled Walls

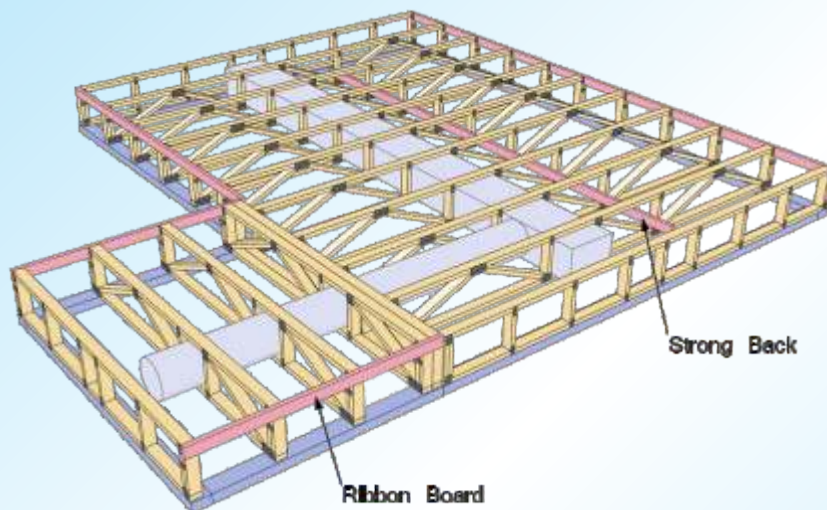

The System 42 floor truss system provide longer, stronger clear spans and greater design flexibility in locating bearing walls and partitions. Because the System 42 floor truss system can be spaced farther apart, fewer are needed. Delivered to the job site ready for installation, the lightweight, rigid floor trusses go up easily and quickly, often without the use of a crane. Wide (3 1/2"), nailable top and bottom chords speed placement of decking and ceiling material without the need of special fasteners or clips. Mechanicals are installed quickly through the opening between webs without notching or furring. Tradesmen are on and off the job faster resulting in earlier completion dates and lower on-site labor costs.

The innovative software, equipment, products and services available from **ITW Building Components Group** allows our customers to manufacture and sell the finest truss and wall components available in North America. ITW BCG offers component engineering services, design and management software, production equipment as well as truss connector plates. The pioneering concepts developed for wood trusses was applied to our revolutionary line of products and services for cold-formed steel components.



Engineering principals are fundamental to everything we do and connections are key...to every truss, to every building, to every component business. Everything is built on trust - trust in the experience and judgment of every professional involved in the project. By designing tools that let each professional connect and build on the work others have done along the way our products help to streamline the entire building process. By connecting more building professionals with the right software and tools we can all work together - building synergy, ITW Building Components Group represents premier brand names including Alpine Engineered Products, Truswal Systems, Alpine Equipment, Intelligent Building Systems, SpaceJoist TE, Ameri-CAD, hsbCAD, TrusSteel, Alpine Systems in Canada and Pryda.

Our parent company is an international corporation with nearly 100 years of history. **Illinois Tool Works Inc.** (NYSE: ITW) is a diversified manufacturer of advanced industrial technology. ITW designs and produces an array of highly engineered fasteners, components, equipment, consumable and specialty products for customers around the globe. Our 825 decentralized business units in 57 countries, employ nearly 61,000 people who are all focused on creating value-added products and specialized customer solutions. www.itw.com



ITW Building Components Group

800.521.9790 - www.itwbcg.com

www.itwact.com - 02/02/12 Version
This guide or any part thereof may not be reproduced in any form without the written permission of ITW Building Components Group Inc.
© Copyright 2012 - All Rights Reserved. 954-979-9698 ext. 4067