

COMEUP WINCH

Getting you through since 1975



SEAL GEN2 SERIES INSTRUCTION GUIDE

To prevent any serious injury, do not install or operate this winch before reading this manual. Keep this manual with the winch at all times. Winch operators must read and understand contents fully. Know the specific function of your winch.

1. Cutout Switch :

Your Seal Gen2 9.5i/9.5si /9.5rsi winch has a cutout switch, it is to activate or deactivate the winch.

The cutout switch could also cut out the battery draw of wireless control models when the engine is not running.

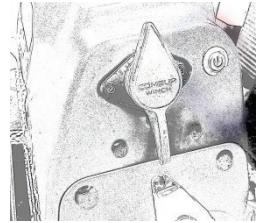

2. Vehicle Battery Level :

The dash board of your Seal Gen2 9.5i/9.5si/9.5rsi winch is with battery indicator to show the status of vehicle battery level.

1st Icon (Green): Fully charged around 12V level

2nd Icon (Green): Fair charged around 11V

3rd Icon (Green): Fair charged around 10 V

4th Icon (Green): Low charged around 9V

5th Icon (Blinking Red): Extreme low below 8V

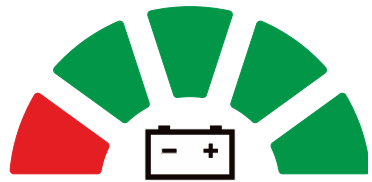

3. Cable in/out direction indicators :

The green triangle icons on the IDB (Intelligence Dashboard) for your Seal Gen2 9.5i/9.5si/9.5rsi will indicate the rope winding direction.

a. Cable in: The green triangle icons moved from the outside toward the center indicate the rope winding-in direction.



b. Cable out: The green triangles icons moved from the center toward the outside indicate the rope winding-out direction.



c. Over-heat: The green triangles icons will turn red if the motor is over-heating, but the direction remains unchanged.



4. Over-heat Protection :

There are three kinds of overheat protection warnings to protect the motor and control from being damaged or personal injury :

a. IDB warning: The flashing red temperature icon on (IDB) of your Seal Gen2 9.5i/9.5si/9.5rsi winch indicates the motor is over-heating.

b. Handheld remote warning: The two green LED indicators on the wired remote control will turn red if the motor is over-heating.

c. Buzzer warning: When motor is over-heating, the Seal Gen2 9.5rs/9.5rsi/12.5rs/16.5rs will induce a buzzer alarm



Temperature Warning

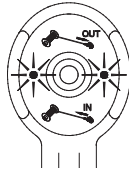

Handheld Remote Warning



Buzzer warning

5. Wireless Remote Control Icon :

- a. While using wireless control, the wireless signal icon of IDB of your Seal Gen2 9.5rsi will turn on.
- b. The LED indicators on the wireless transmitter indicate the signal condition. If green, the signal is good; red is weak.



Wireless Signal Icon



Wireless Transmitter

6. Wireless transmitter's battery life :

If green LED indicator on the wireless transmitter is flashing, the battery of the transmitter need to be replaced.











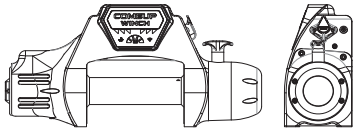
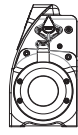



► Wireless Receiver & Transmitter











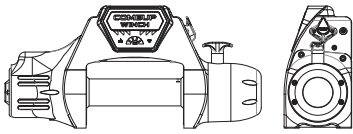

This wireless remote control device complies with CE mark, FCC and Industry Canada (IC) rules. There are four control modules of Sean Gen2 series winches. All are similar in setup, but with differing responses in regards to their control type.

- 1). Seal Gen2 9.5rsi :
 - a. With both wireless and wire remote control.
 - b. IDB with wireless remote control function + cutout switch + temperature warning and overheat buzzer warning.
 - c. After activating the winch, the logo LED will light on and battery indicator shows the status of battery level. At the same time, the wireless remote control icon will be blinking with buzzer warning until the remote control is tuned.
 - d. Cable in/out direction indicators.
- 2). Seal Gen2 9.5i/9.5si :
 - a. With wired remote control.
 - b. IDB + cutout switch + temperature warning and over-heat buzzer warning.
 - c. Cable in/out direction indicators.
- 3). Seal Gen2 9.5rs/12.5rs/16.5rs :
 - a. With both wireless and wire remote control.
 - b. Overheating buzzer warning.
- 4). Seal Gen2 9.5/9.5s/12.5/12.5s/16.5/16.5s :
 - a. With wire remote control.

- Seal Gen2 9.5rsi with IDB (Intelligence Dashboard), cutout switch and buzzer warning.
- 1).Wireless remote control module :

Applicable models		Seal Gen2 9.5rsi					
LED & Buzzer							
		LOGO				Transmitter LED	
Turn on		on	on	Blinking	2 short beeps for 1 minutes	X	
Press Transmitter for 5 seconds				on	Blue	Long beeps for 5 seconds	Turn on Green
Programming							
If programming failed , Winch will automatically use the previous programming after 1 minute.							
Cable in/IDB LED (Green)					X	Red	
Cable out/IDB LED (Green)							
Motor overheating warning  (Blinking)	Cable in/IDB LED (Red)				2 short beeps every 5 seconds	Green	
	Cable out/IDB LED (Red)						
	No operation						
Low voltage on transmitter		Light on	Light on	Light on	X	Green	
Poor signal warning						Red	
Press the power button for 5 seconds to turn transmitter off.						X	
Press the power button to turn winch off.		X		X		X	



2).Wired remote control module :

Applicable models		Seal Gen2 9.5i/9.5si/9.5rsi				
LED & Buzzer						
		LOGO				Remote Control LED
Press the power button to turn winch on.		Light on	Light on	Blinking (remark 1.)	2 short beeps for 1 minutes (remark 2)	X
Plug in connector					Green (remark 2)	Green
Cable in/IDB LED (Green)					X	Green
Cable out/IDB LED (Green)						
Motor overheating warning  (Blinking)	Cable in/IDB LED (Red)				2 short beeps every 5 seconds	Red
	Cable out/IDB LED (Red)					
	No operation	Light on	Light on	Light on (remark 3)		
Press the power button to turn winch off.		X				

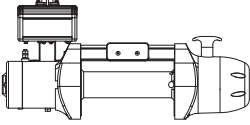

Remarks:

1. Seal Gen2 9.5i/9.5si: No wireless signal icon.
2. Seal Gen2 9.5i/9.5si: Buzzer won't be activated accordingly.
3. Seal Gen2 9.5rsi: Turn winch on, winch will automatically use the previous programming.

3).Wireless remote control or wired remote control (2 LEDs on wired remote control and buzzer in the control box), For Seal Gen2 9.5rs/12.5rs/16.5rs only :

Applicable models		Seal Gen2 9.5rs/12.5rs/16.5rs		
LED & Buzzer				
		Buzzer	Transmitter LED	Remote Control LED
Press the power button on transmitter for 5 seconds to turn transmitter on.		X	Green	X
Cable in/out operation		X	Red	Green
Motor overheating warning	Cable in/out	2 short beeps every 5 seconds	X	Red
	No operation			
Low voltage on transmitter		X	Blinking green	X
Poor signal warning		X	Blinking red	X
Press the power button of transmitter for 5 seconds to turn transmitter off.		X	X	X

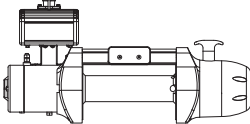
4).Wired remote control (2 LEDs on remote control), For Seal Gen2 9.5/9.5s/12.5/12.5s/16.5/16.5s only :

Applicable models		Seal Gen2 9.5/9.5s/12.5/12.5s/16.5/16.5s	
LED & Buzzer			
		Buzzer	LEDs on remote control
Plug in connector		X	Green
Cable in/out operation		X	Green
Motor overheating warning		X	Red
Plug out connector		X	X

► Power on the winch (Getting started)

1. Cutout Switch :

Your Seal Gen2 9.5i/9.5si/9.5rsi winches can be activated by the cutout switch.

1.1 Press the cutout switch button to activate the winch operation. Verify a red light appears around the button.

1.2 The white COMEUP winch logo icon will bright up for Seal Gen2 9.5i/9.5si/9.5rsi, battery indicator icons will light on in green.

1.3 The wireless control device is in tuning.

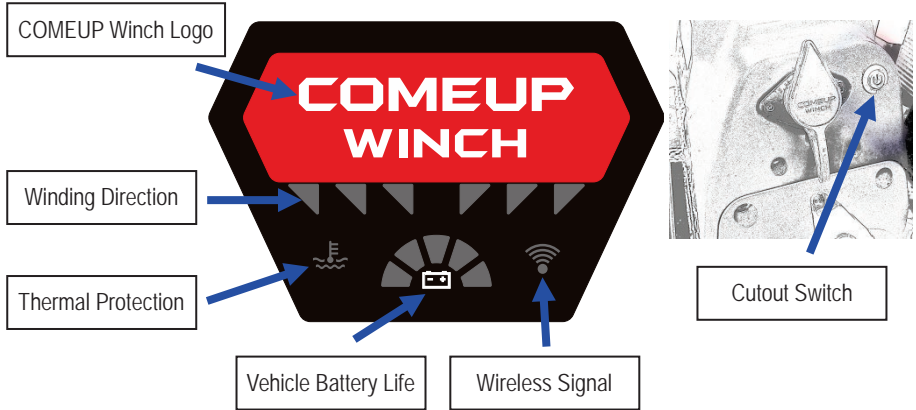

2. Handheld switch :

All automotive winches are supplied with a wired remote control to activate and operate the winch. Two green LEDs indicator the winch is under operation.

3. Wireless Transmitter :

Your Seal Gen2 9.5rs/9.5rsi/12.5rs/16.5rs comes with wireless transmitter can be operated by wireless remote control.

Press and hold the power button for 5 seconds to activate winch operation. The green LED Indicator lights up.

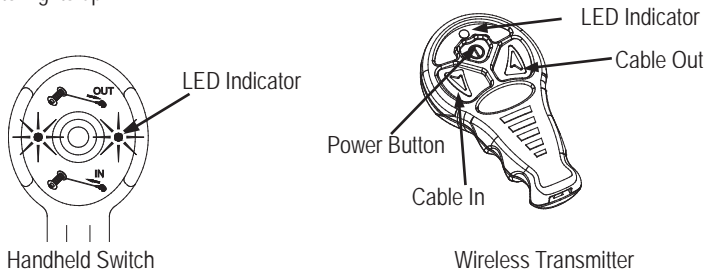

► Wireless Recovery & Transmitter

1. Battery replacement

When the green LED Indicator is flashing indicates an extreme low battery level of wireless Transmitter. The battery should be replaced.

1. Loose the three screws from the back cover of the wireless transmitter.
2. Separate the top section and remove the old battery (and dispose it).
3. Insert new 3V lithium battery and join the top section with the bottom section.
4. Make sure to fasten the three screws.

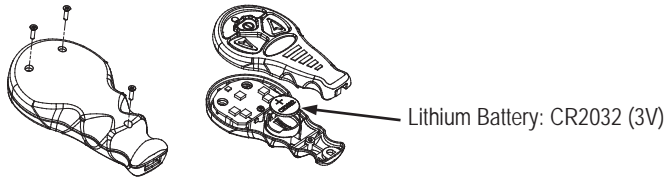

2. Pairing the wireless remote control

Your wireless remote control is already paired to your winch, however a replacement will need to be paired.

1. Attach the winch power red lead to the positive (+) battery terminal and attach black ground lead to the negative (-) battery lead, the buzzer beeps for 5 minutes
2. Press and hold the power button for about 5 seconds, the LED Indicator illuminates green permanently.
3. Press either cable in button or cable out button for pairing. The blinking LED indicator will light up while pairing
4. If pairing was successful, The LED indicator lights up and the buzzer sounds a long beep lasting for 5 seconds
5. If pairing was unsuccessful after 5 minutes, the power LED indicator will turn off and it need to restart the pairing.

► Power Off the winch (Shut down)

1. Cutout Switch :
Press the cutout switch button to terminate your Seal Gen2 9.5i/9.5si/9.5rsi winches operation.
2. Wireless Transmitter :
 - 2.1 Press and hold the power button for 5 seconds for wireless controlled winches.
 - 2.2 The green LED indicator at the wireless transmitter will turn off after winch shutting down.
 - 2.3 The winch will be shut down automatically if at idle for 5 minutes.

► Battery Recommendations and lead size

A fully charged battery and good connections are essential for the proper operation of your winch. The minimum requirement for battery is 650 cold cranking amps. The voltage drop for the winch motor must not exceed 10% of the nominal voltage of 12/24V DC.

The battery lead shall be 2 gauge with 1.83 m in length at most, otherwise a considerable voltage drop will be happened.

► **Wiring Diagram**

Attach the black lead firmly to the negative (-) battery terminal and red lead to the positive (+) battery terminal. The voltage drop for the winch motor must not exceed 10% of the nominal voltage of 12/24V DC.

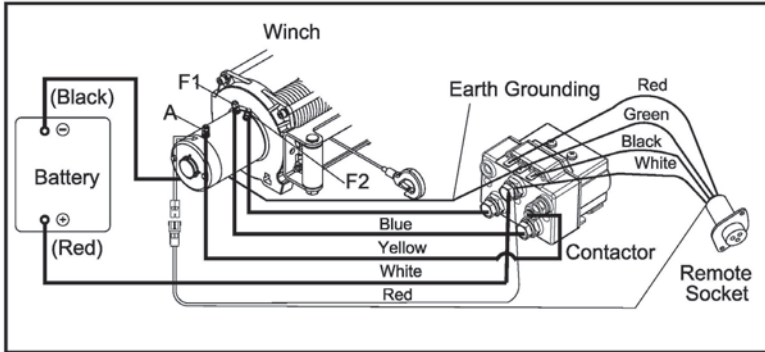

► **Cable-in/Cable-out Operation**

1. **Wired Remote Control :**

- 1.1 To " winch or cable - out", trigger → out.
- 1.2 To " winch or cable - in", trigger ← in.
- 1.3 To stop winching, release the trigger.

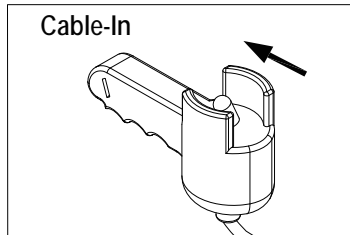
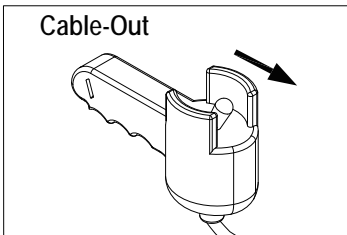

2. **Wireless Control Module :**

- 2.1. Press and hold the cable in button of the transmitter for rope winding in operation.
- 2.2. Press and hold the cable out button of the transmitter for rope winding out operation.
- 2.3. Stop winching, release the cable in or cable out buttons.

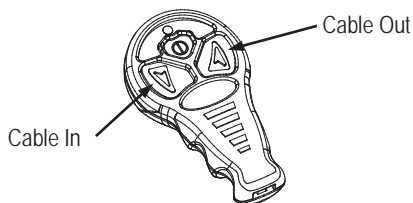

3. Additional Emergency Stop Function:

The power button also works as an emergency stop if the radio control is in malfunction of any reason. While the radio control is in operation (either winch in or winch out, the red light is on), once power button is pressed, the radio control will be forced to power off immediately. Winch will stop running accordingly.

► **Shut Down the Winch Permanently**

1. Cutout Switch :

Press the cutout switch button to activate the wired controlled winch operation. Verify a redlight turns off.

2. Wired Remote Control :

Remove the Handheld switch from the winch when not in use.

► **Clutch Function**

1. The clutch allows rapid pay-out of the wire/synthetic rope for hooking onto a load or anchor points and is operated by a clutch T-handle.
2. The clutch T-handle must be in the "Engaged" position before winching.
3. To disengage, Lift the clutch T-handle up and turn it counter-clockwise to the "Disengaged" position. Wire / synthetic rope can now free spool off the drum.
4. To engage, Lift the clutch T-handle up and turn it clockwise to the "Engaged" position.
5. If a clutch T-handle can't be properly locked in the "Engaged" position, rotate the drum to help the clutch device engage the gear train.
6. Wear gloves and use a hand saver strap when guiding the wire / synthetic rope off the drum.
7. Never disengage the clutch while wire / synthetic rope is under load.

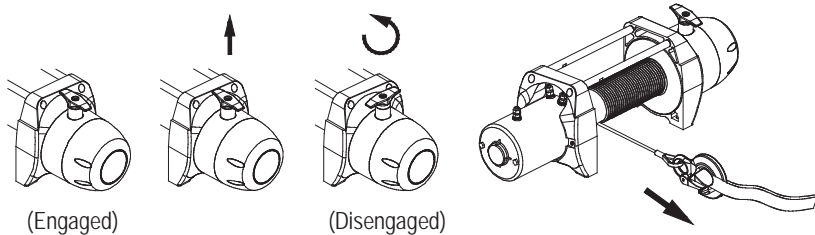

► Clutch Repositioning

Change the position of the Free-Spool T-handle according to the following steps.

1. Loosen and release the bolts on the brake rear cover for separating the brake rear cover away.
2. Loosen and release the bolts on the gearbox away for separating the gear box away.
3. Rotate the gearbox by a proper angle increments mentioned on the below chart to the required position.
4. Re-assembly the gearbox and rear brake cover.

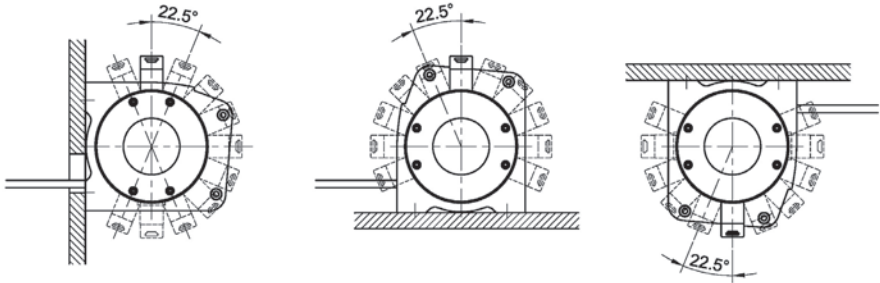

► Mounting Configurations

The payout direction for wire rope/synthetic rope or the correct methods for mounting the winch vary according to different winch model. Do wind the rope from the bottom of the drum. At any condition, do not position the load direction away from the mounting base plate.

Winch Model	Mounting Position		Repositioning	
	Foot Down	Foot Forward	Clutch Angle	Motor Angle
Seal Gen2 9.5/9.5s/9.5rs	V	V	22.5°	X
Seal Gen2 9.5i/9.5si/9.5rsi	V	V	22.5°	X
Seal Gen2 12.5/12.5s/12.5rs	-	V	22.5°	X
Seal Gen2 16.5/16.5s/16.5rs	-	V	90°	90°

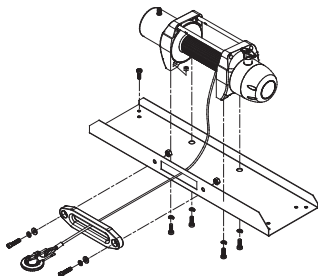

Foot Down Mounting Position

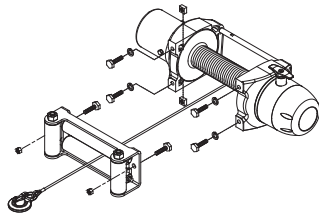

Foot Forward Mounting Position



Seal Gen2 Series Winch

Limited Lifetime Warranty for Mechanical Components
Limited Three(3) Year Warranty for Electrical Components

Seal Gen2 Series WARRANTY

Comeup Industries Inc. (COMEUP) warrants to the original purchaser that the mechanical components of the COMEUP Automotive Winch will be free of defects in material and workmanship for the lifetime of the winch and the electrical components will be free of defects in material and workmanship for a period of three (3) years for Seal Gen2 winches from the original date of purchase. All COMEUP mounting kits and other accessories carry a one (1) year limited warranty against defects in material workmanship.

This warranty applies only to the original purchaser of the winch. To obtain any warranty service, the purchaser under this Limited Warranty is requested to advise COMEUP or its authorized distributors on any claim. The purchaser must provide a copy of the purchase receipt bearing the winch serial number, date of purchase, owners name, email or Tel & Fax, address and purchaser vehicle details. Any products that COMEUP determines to be accountable for defective will be repaired or replaced or refund at COMEUP sole discretion without charge to buyer upon buyer's compliance with these procedures. In the event of repair or replace, purchaser must send the defective winch or part, with freight prepaid, to COMEUP or its authorized distributor. And COMEUP will send the serviced product back to purchaser on COMEUP's cost. This warranty does not cover the removal or reinstallation of the winch.

COMEUP takes the responsibility for COMEUP winch parts and components to be free from defects in materials and workmanship, but the following portions are hereby excluded and disclaimed. COMEUP or its authorized distributors may make reasonable charges for parts and labour for repairs or resumption in the following portions not covered by this limited warranty.

- (1). All warranties of wire rope and synthetic rope assemblies after initial use
- (2). All warranties of fitness for a particular purpose
- (3). All warranties of the product's finish
- (4). All warranties of merchantability

The limited warranty does not cover any failure that results from improper installation/operation, third party part substitution, purchaser's alteration or modification on COMEUP winch. This warranty is void when COMEUP serial number plate is removed or defaced.

COMEUP's liability to the purchaser under the winch purchases for any loss or damage howsoever and whatsoever arising shall not exceed the price of the initial winch purchase receipt. COMEUP shall not in any event be liable to the purchaser for any consequential and/or indirect loss or damage whether for loss or for profit or otherwise, costs, expenses or other claims for consequential compensation whatsoever and whether caused by negligence of COMEUP employees, distributors and their employees or otherwise. COMEUP reserves the right to change product design without notice. In situations in which COMEUP has changed a product design, COMEUP shall have no obligation to upgrade or otherwise modify previously manufactured products.

**COMEUP
WINCH**

COMEUP INDUSTRIES INC.

No.139, Jieyukeng Rd., Ruifang Dist.,
New Taipei City 22453, Taiwan

Tel: +886-2-24971788

Fax: +886-2-24971699

Email: info@comeup.com.tw

www.comeupwinch.com

PN 883192 Ver:00

Specifications subject to change without notice.