

Green Wave Fusion Professional-Grade Backwashing Filter For Iron, Sulfur and Manganese



Green  Wave
Fusion

Owners Manual

Models:

385-GWFS-1000, 385-GWFS-1500, 385-GWFS-2000

US Water Systems Corporate Office
1209 Country Club Road
Indianapolis, IN 46234
1-800-608-8792
info@uswatersystems.com

REVISION # 1.1
REVISION DATE May 4, 2015

Table of Contents

Unpacking/Inspection.....	2
Safety Guide.....	2
Proper Installation.....	3
Component Introductions.....	3
Overhead Installation Drawing.....	6
Importance of Contaminant Removal Prior to the GreenWave Tank.....	9
Fusion Superfilter Installation Instructions and Specifications.....	10
Superfilter Tank and Control Valve Preparation.....	10
20 Micron Sediment Filter Installation Instructions.....	12
Superfilter Katalox Tank Installation Instructions.....	16
5 Micron Sediment Filter Installation Instructions.....	18
GreenWave Tank Installation Instructions.....	22
US Water UV Light Installation Instructions.....	23-24
1 Micron Sediment Filter Installation Instructions.....	26
Control Valve Keypad Functions and Backwash Initiation.....	30
Control Valve Programming.....	31
System Start-up Instructions.....	32
GreenWave Tank Startup Instructions.....	33
What To Expect and Routine Maintenance.....	34
Boil Test.....	35
Maintenance Schedule.....	36
Limited Lifetime Warranty.....	37

Unpacking / Inspection

Be sure to check the entire system for any shipping damage or parts loss. Also note damage to the shipping cartons. Contact US Water Systems at 1-800-608-8792 to report any shipping damage within 24 hours of delivery. Claims made after 24 hours may not be honored.

Small parts, needed to install the system, are in a parts bags. To avoid loss of the small parts, keep them in the parts bag until you are ready to use them.

Safety Guide

- Check and comply with your provincial / state and local codes. You must follow these guidelines.
- Use care when handling the water treatment system. Do not turn upside down, drop, drag or set on sharp protrusions.
- The carbon Superfilter system works on 12 volt-60 Hz electrical power only. Be sure to use only the included transformer.
- Transformer must be plugged into an indoor 120 volt, grounded outlet only.
- **WARNING:** This system is equipped with a UV light to remove biological contaminants. Although this treatment system is in place, US Water Systems recommends that bacteria levels be checked periodically to ensure the UV light system is operating properly. Coliform and E.coli most importantly.

Proper Installation

This water treatment system must be properly installed and located in accordance with the Installation Instructions before it is used or the warranty will be void.

- **Do not** install or store where it will be exposed to temperatures below freezing or exposed to any type of weather. Water freezing in the system will break it. Do not attempt to treat water over 100°F.
- **Do not** install in direct sunlight. Excessive sun or heat may cause distortion or other damage to non-metallic parts.
- Properly ground to conform with all governing codes and ordinances.
- Use only *lead-free solder and flux* for all sweat-solder connections, as required by state and federal codes.
- Maximum allowable inlet water pressure is 125 psi. If daytime pressure is over 80 psi, night time pressure may exceed the maximum. Use a pressure reducing valve to reduce the pressure.
- **WARNING:** Discard all unused parts and packaging material after installation. Small parts remaining after the installation could be a choke hazard.

Fusion Superfilter System Introduction

The Fusion Superfilter system provides iron, sulfur and manganese removal throughout the home. The Fusion Superfilter system should be installed at the point of entry to treat your entire home, both hot and cold water.

The Fusion Superfilter system backwashing tank removes iron, sulfur and manganese using oxidation. When water is used in the home, the Fusion Superfilter will remove the contaminants by splitting the ions in the water. The Katalox Light media in the Fusion Carbon Superfilter system tank provides filtration when the system is in service to collect contaminants oxidized during the ion splitting process. These contaminants are backwashed from the media surface when the system regenerates.

Fusion Superfilter Benefits

- Iron, Manganese & Sulfur Removal
- Virtually maintenance free.
- Improves the efficiency of water-using appliances
- Simple installation
- Safe for landscaping and lawn watering.
- Compatible with all on-site and community wastewater treatment systems

GreenWave Tank Introduction

The GreenWave Fusion system provides protection from scale formation throughout the home. The GreenWave system should be installed after the Fusion Superfilter system to treat your entire home, both hot and cold water, or it can be located directly before a water heater or other device (e.g. sauna, etc) that requires protection from hard water.

The GreenWave Fusion reduces or eliminates scale formation on internal and external plumbing surfaces as well as reducing spotting and streaking normally associated with hard water.

The GreenWave Fusion prevents scale by transforming the normal dissolved hardness minerals into undissolved crystal micro-particles. These crystals stay suspended in the water and dramatically reduce the scaling potential of hardness minerals. Therefore the problem of internal buildup of scale in pipes, water heaters, water fixtures and glass is greatly reduced.

The GreenWave Fusion is not a water softener – Low or phosphate-free cleaning products are recommended to achieve optimum results. Modern surfactant or detergent based, liquid soaps are preferred over old-fashioned fashioned caustic solid soaps.

Unlike softened water, the GreenWave Fusion treated water maintains the beneficial essential mineral content of your water and is safe to drink.

GreenWave Tank Benefits

- Chemical Free Scale Prevention. Cost savings and environmental benefits
- Virtually Maintenance Free. No salt bags or other chemicals to buy, transport and store
- Beneficial minerals retained for more healthful drinking water
- Improves the efficiency of water-using appliances
- Simple installation – no electrical and drain hookup
- Safe for landscaping and lawn watering. No need for costly plumbing bypasses
- Compatible with all on-site and community wastewater treatment systems
- Not subject to water softener restrictions and "bans"

US Water UV Light Introduction

This point-of-use system allows for simple installation and operation due to its high output lamp and compact reactor. The reactor is an axial flow design with superior hydraulics, compact design and 1" NPT connections. The controller is a simple plug in device connecting to the lamp with a safety cap.

Water Quality Guidelines

Iron	< 0.3 ppm (0.3 mg/L)
Hardness	< 7 gpg (120 mg/L)
Turbidity	< 1 NTU
Manganese	< 0.05 ppm (0.05 mg/L)
Tannins	< 0.1 ppm (0.1 mg/L)
UV Transmittance	> 85%

The UV light system uses ultraviolet light to kill bacteria and other organics in the water source. The light from the UV bulb passes through the water and destroys the organic contaminants. The UV bulb utilizes a quartz sleeve on the outer portion to isolate the water from the UV bulb element.

WARNING!

If this quartz sleeve becomes coated or stained it will reduce the light that can pass through the water in the chamber, thus inhibiting the bacteria removal by the UV light. It is crucial that the iron, manganese and any tannins in the water are removed prior to the UV to ensure the light is penetrating the quartz sleeve and its' full intensity.

US Water UV Light Introduction

Operation

The US Water Systems UV comes with a feature laden controller that incorporates both the lamp driver (ballast) and control features in one water-tight case. **CAUTION:** Prior to performing any maintenance on your UV system, you must always disconnect the power.



USWATER 5.0 & USWATER 6.0 Controller

This controller features a power factor corrected, constant current lamp driver with a universal power input. A full color LCD screen provides the user with a detailed description of the system's performance in addition to providing any applicable fault messages and system diagnostics. The controllers used in both the USWATER5.0 and USWATER6.0 are identical. The difference is that the USWATER 6.0 series of products includes a UV intensity monitor. All USWATER 5.0 and USWATER 6.0 controllers include an "infinite expandability port" located on the right side of the controller. Simply plug in an optional UV sensor module into the expandability port of a USWATER 5.0 controller and the system will now monitor the UV intensity of the system!

US Water UV Light Introduction

USWATER 5.0 & USWATER 6.0 Power-up Sequence

Upon start up, the 5.0 & 6.0 controller will run through a diagnostic start-up and the sequence will be displayed as follows on the color LCD:



Next, the controller checks for the installation of any optional modules that may be installed on the system. It first checks to see if a module is installed and then either initializes the module to function with the controller or returns a "not detected" screen and moves on to the next module. The screens will appear as follows:

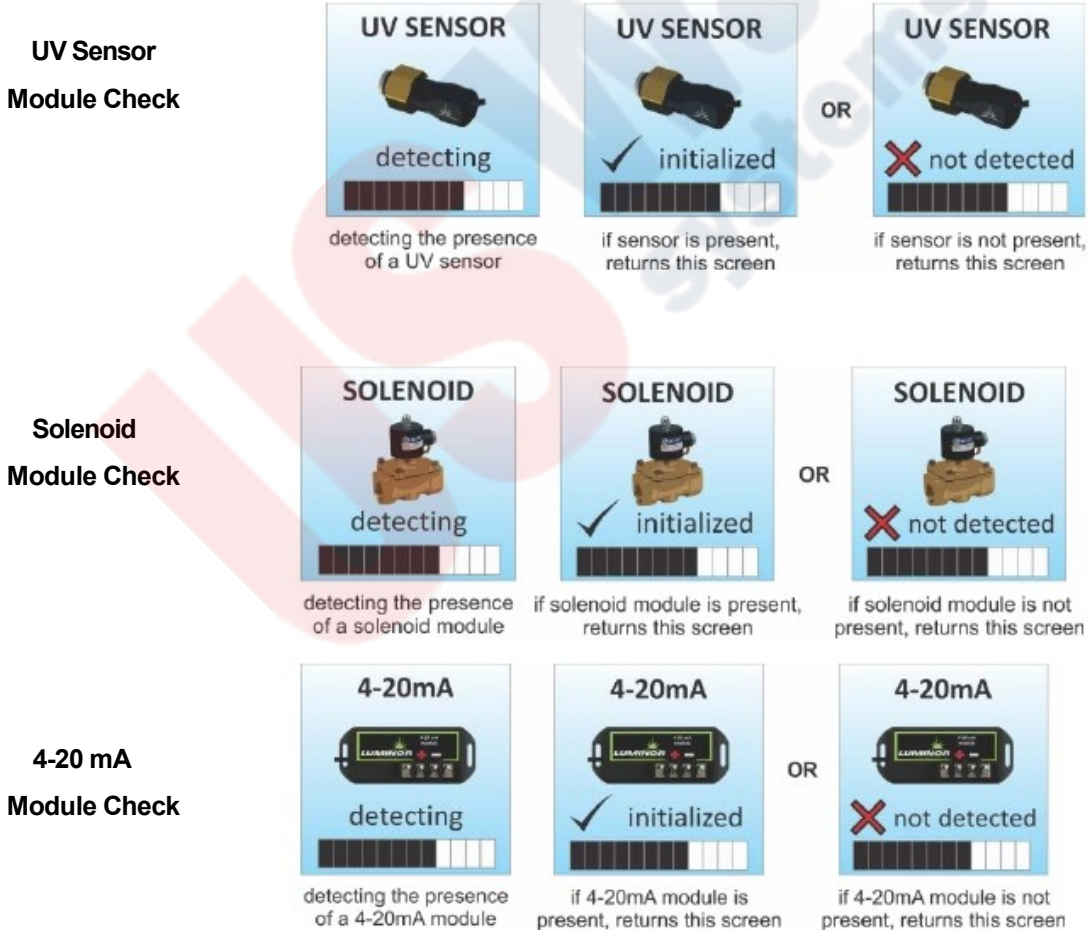

US Water UV Light Introduction

Ethernet Module Check

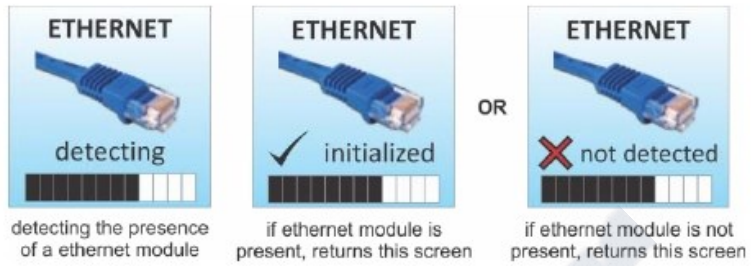

Remote Alarm Module Check

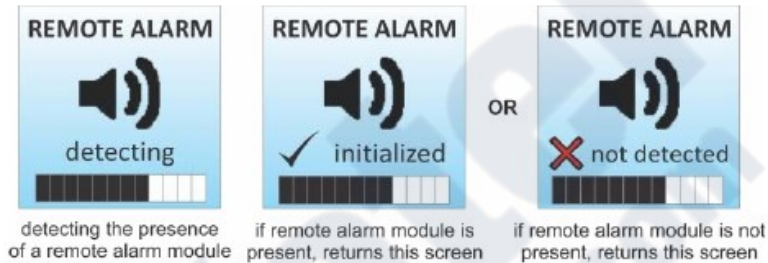

Once the controller has finished checking for the installation of all available modules a single screen is displayed showing which specific modules are installed and activated on this particular system. **Please Note:** If the corresponding module icon is not displayed on this screen, then that module is not installed on this system. If you believe this module is installed correctly, recheck the applicable connections to ensure a solid connection point and then restart the controller. The controller then continues to optimize the lamp efficiency by waiting 60 seconds to allow the lamp to reach its optimum output. Finally, a final "start-up complete" screen is displayed. These screens will appear as follows:



USWATER 5.0 Operational Screens

On USWATER5.0 systems (without the UV monitor), the default screen shows the **US Water Systems Home Screen**. At any point during operation the user is able to scroll through the **US Water Systems Home Screen**, **Lamp life remaining** and **QR Code/Contact Info** screens by simply pressing the button located on the front of the controller.

US Water UV Light Introduction



USWATER 6.0 Operational Screens

On systems that have the UV module installed (and on all USWATER6.0 systems), the default screen shows the **% UV Intensity**. At any point during operation the user is able to scroll through the **% UV Intensity**, **Lamp life remaining** and **QR Code** screens by simply pressing the button located on the front of the controller.

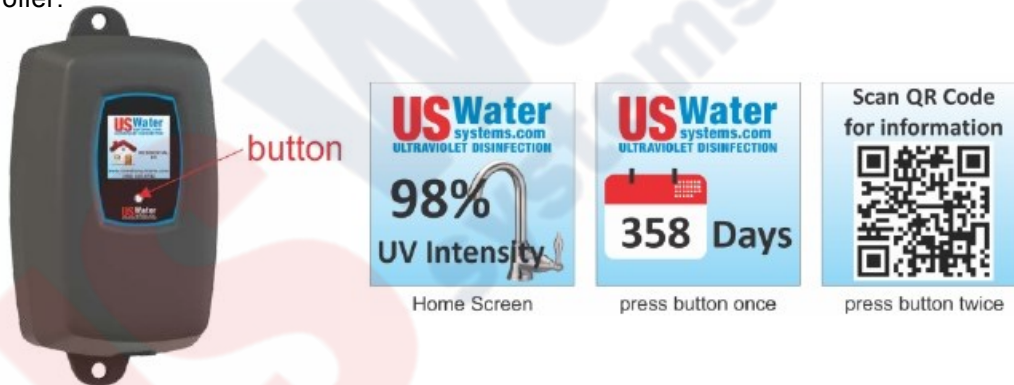

USWATER 6.0 % UV Intensity

If your system is equipped with a UV sensor the % UV Output screens will indicate the level of UV intensity that is being detected within the reactor by the sensor. This will always be visible on the Home Screen of the controller. Things that can affect the % UV Output are poor water quality, scaling of the quartz sleeve and/or sensor, lamp failure, expired lamp life and sensor failure. The following screens show the % UV Output dropping on a monitored system.

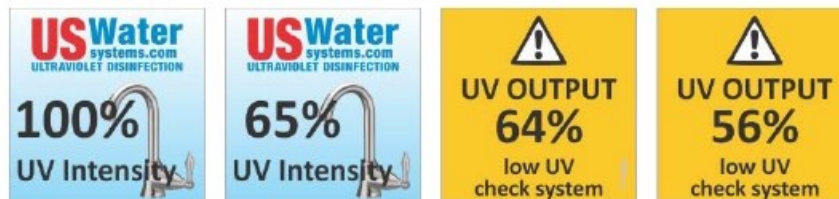

US Water UV Light Introduction

Once the UV output drops below 56%, the numbers and warning sign switch to red and a 15 second intermittent audible chirp is given off by the ballast. When the output drops below 51%, the display switches to a solid red and a constant audible signal is provided. The screens alternate between this solid red screen and another screen indicating "water may be unsafe for consumption". At this point, the controller also provides a signal to de-activate the solenoid valve, shutting off the flow of water if a solenoid valve is installed on the system.

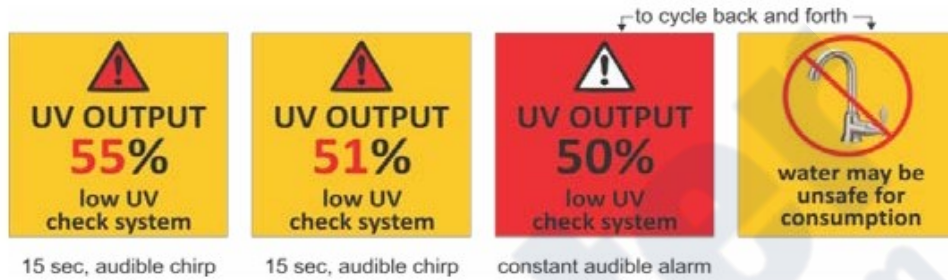

USWATER5.0 & USWATER6.0 Lamp Countdown Sequence

The USWATER5.0 & USWATER6.0 counts down the number of days until a lamp change is required. The operation is as follows:



Once the lamp has seven days remaining until a lamp change is required, the screen changes to a yellow caution screen. At this point, an audible chirp is given off by the ballast to draw your attention to the pending lamp change condition. When the controller passes the zero day threshold, the screen changes to solid red and cycles between a red "lamp expired" screen and a "water may be unsafe for consumption" screen. The same intermittent audible chirp is heard throughout this lamp expired sequence.



At any point during this sequence, the audible chirp can be deferred by holding the controller button down for a period of five seconds. The screen shown below will appear for five seconds indicating that the audible deferral has been activated and then the system switches back to the current lamp change or lamp expired screen. This audible deferral will last for seven days after which then the alarm will sound once again. This audible deferral feature can be activated as many times as you wish. **PLEASE NOTE:** During the condition of lamp expiration and audible deferral, the water may be unsafe for consumption and should not be consumed without another form of disinfection.



US Water UV Light Introduction

USWATER5.0 & USWATER6.0 Lamp Countdown Reset Sequence

After changing the lamp on the USWATER5.0 & USWATER.0 systems, the controller must be reset in order for the system to begin its countdown function on the newly installed lamp. To perform this reset, you must firmly depress the button on the front of the controller and then manually plug the power cord back into the wall outlet initiating power to the unit. Keep holding down the button for five seconds until you hear an audible chirp indicating the controller has reset the internal timer.

Release the switch and the lamp countdown feature has now been reset. The following two screens will be displayed during this process.



USWATER5.0 & USWATER6.0 Failure Modes

The US Water Systems controller continuously monitors your UV system and if there is a problem with the system the controller will provide both a visual and audible signal indicating the specific fault that may be adversely affecting the operation of your system. The fault conditions are listed in a priority sequence as follows:



LAMP FAILURE: If at any time during the operation of the system, the UV lamp fails to be illuminated, the controller will return both an audible and visual signal indicating lamp failure. In addition, a constant audible buzzer will sound during lamp failure.

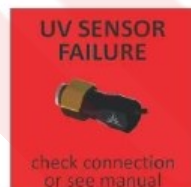

UV SENSOR FAILURE: Assuming the system has a UV Sensor installed, if at any time during the operation of the system, a UV sensor fails, the controller will return both an audible and visual signal indicating sensor failure. For sensor failure, the controller will cycle between "sensor failure" and "water may be unsafe for consumption" screens as an added precaution. In addition, a constant audible buzzer will sound during sensor failure.



US Water UV Light Introduction

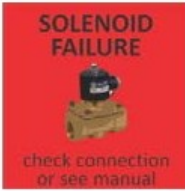

SOLENOID MODULE FAILURE: Assuming the system has an optional Solenoid Module installed, if at any time during the operation of the system, a solenoid valve fails to operate, the controller will return both an audible and visual signal indicating solenoid failure. In addition, an intermittent (15 sec) audible buzzer will sound during solenoid failure.



4-20 mA MODULE FAILURE: Assuming the system has an optional 4-20 mA Module installed, if at any time during the operation of the system, a 4-20 mA module fails, the controller will return both an audible and visual signal indicating a 4-20 mA failure. In addition, an intermittent (15 sec) audible buzzer will sound during a 4-20 mA failure.



REMOTE ALARM MODULE FAILURE: Assuming the system has an optional Remote Alarm Module installed, if at any time during the operation of the system, a remote alarm module fails, the controller will return both an audible and visual signal indicating remote alarm failure. In addition, an intermittent (15 sec) audible buzzer will sound during remote alarm failure.



ETHERNET MODULE FAILURE: Assuming the system has an optional Ethernet Alarm Module installed, if at any time during the operation of the system, an Ethernet module fails, the controller will return both an audible and visual signal indicating Ethernet failure. In addition, an intermittent (15 sec) audible buzzer will sound during Ethernet failure.

USWATER 5.0 & USWATER 6.0 QR Codes

A **QR code** (abbreviated from Quick Response code) is a type of matrix barcode (or two-dimensional code) first designed for the automotive industry. US Water Systems uses the QR code to store a link to a specific page on our website. Users with a camera phone equipped with the correct reader application can scan the image of the QR code and over a wireless network connect to a US Water Systems web page in the phone's browser. US Water Systems' QR webpage has information on how to purchase replacement components as well as a helpful video directory on system servicing (i.e. How to change a UV lamp or quartz sleeve). To access the QR code on the USWATER5.0 or USWATER6.0 controller simply press the control button twice and the QR code screen will appear as follows:



Installed System Overhead View

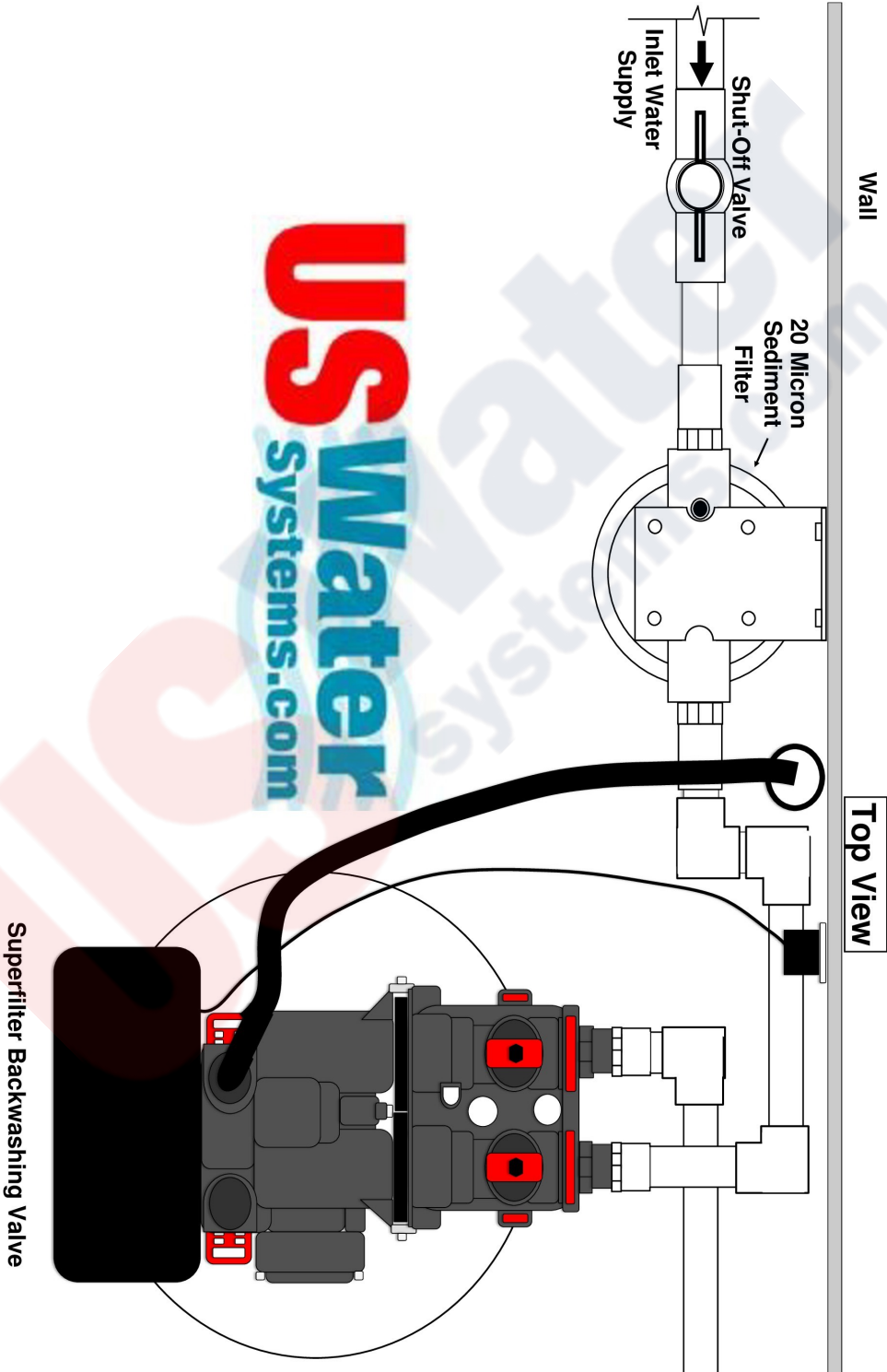

Installed System Overhead View

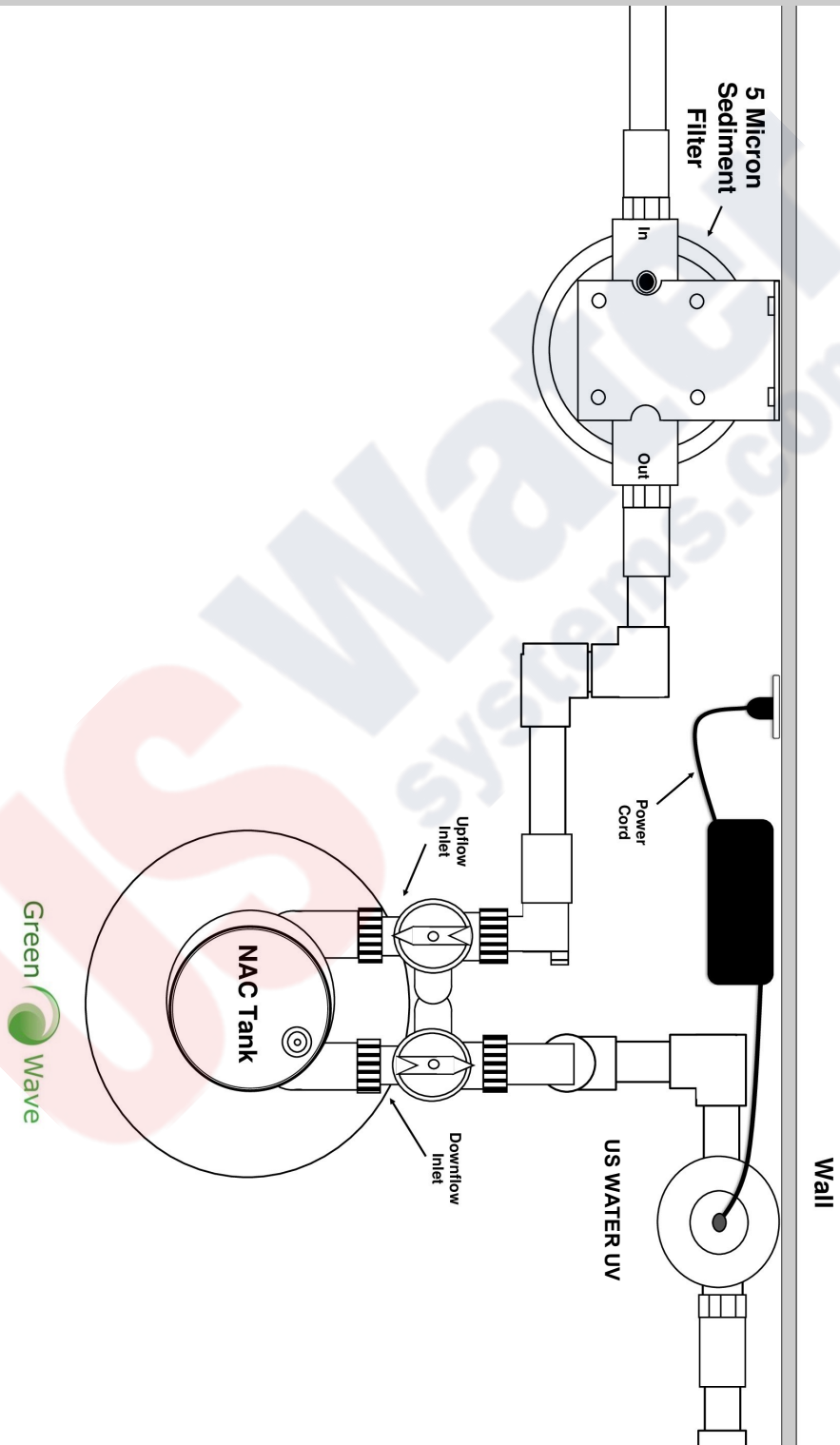

Installed System Overhead View

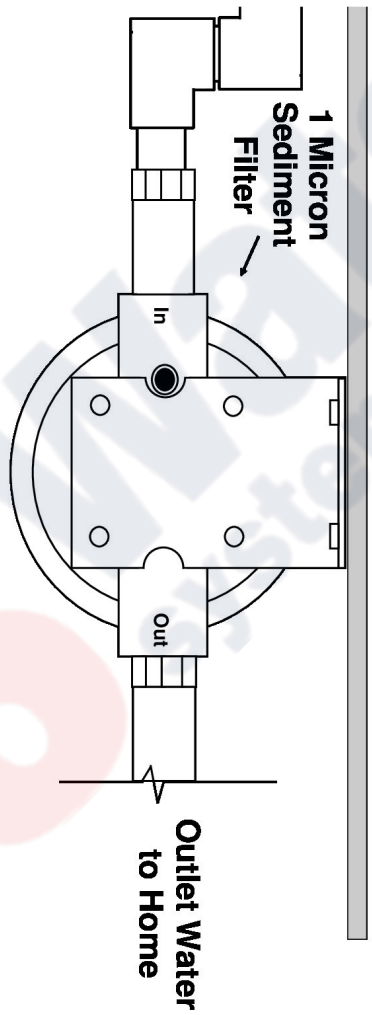

The Importance of Contaminant Removal Prior to the GreenWave Tank

Iron and Manganese

Just as with conventional water softening media, the GreenWave media needs to be protected from excess levels of certain metals that can easily coat the active surface, reducing its effectiveness over time. Public water supplies rarely, present a problem, but if the water supply is from a private well confirm that the levels of iron (Fe) and manganese (Mn) are less than 0.3 mg/L and 0.05 mg/L respectively. Copper should be less than 1.3 mg/L.

Copper

Copper usually originates from new copper plumbing upstream of the GreenWave Fusion system. If this condition exists, we recommend waiting 3-4 weeks before placing the system in operation. This will allow the copper surfaces to be fully flushed and develop a natural protective surface. To further minimize any problem with excess copper the installers should be advised to avoid applying excess flux on the inner surfaces of the pipe and to use a low-corrosivity water soluble flux listed under the ASTM 8813 standard. Once the plumbing connections are complete, place the GreenWave Fusion system in bypass prior to following the startup procedure and flush the plumbing for at least 10 minutes.

Cautions!

- Do not let the system freeze. Damage to the tank and pre-filter may result.
- The system must be operated in a vertical position. Do not lay it down during operation. The system may be placed in any position for shipping and installation but must be operated in the vertical position.
- Place the system on a smooth, level surface. Because the system operates in an UP-Flow, fluidized bed mode, having a level surface is more important than with a softener or media filter.
- A bypass valve should be installed on every system to facilitate installation and service (supplied).
- Observe all local plumbing and building codes when installing the system.

Notes to the Installer

The GreenWave Fusion system differs from a conventional softener or media filter in a number of key respects.

- The system is light and only partially filled with media. This is normal. The UP-flow operation of the system requires a large area of freeboard in the tank to allow the bed to fully fluidize.
- The GreenWave tank has no under-bed so you can tip the system over without any fear of upsetting the media. This makes transportation and installation much easier than conventional systems. The Fusion Superfilter does have under-bedding and should not be moved once filled.
- Because the GreenWave Fusion system operates in the UP-Flow mode (GW Tank), the tank connections are opposite of what a normal softener will use.
- Please see the "important note about iron, manganese and copper" above.

Fusion Superfilter Installation Instructions and Specifications

WATER PRESSURE: A minimum of 20 pounds of water pressure is required for re-generation valve to operate effectively.

ELECTRICAL FACILITIES: An uninterrupted alternating current (A/C) supply is required. Note: Other voltages are available. Please make sure your voltage supply is compatible with your unit before installation.

EXISTING PLUMBING: Condition of existing plumbing should be free from lime and iron buildup. Piping that is built up heavily with lime and/or iron should be replaced.

LOCATION OF FUSION SUPERFILTER TANK AND DRAIN: The Fusion Superfilter tank should be located close to a drain to prevent air breaks and back flow.

BY-PASS VALVES: Always provide for the installation of a by-pass valve if unit is not equipped with one. The Fusion Superfilter is equipped with a bypass valve.

CAUTION: Water pressure is not to exceed 80 psi, water temperature is not to exceed 110°F (43°C), and the unit cannot be subjected to freezing conditions or direct sunlight.

Superfilter Tank and Control Valve Preparation

1. Use a piece of duct tape to cover the top of the distributor tube in the tank. Be sure the distributor tube is centered in the tank. The distributor tube should be flush with the top of the tank or no more than 1/4" below flush. Install the supplied funnel and pour the gravel in the tank first. Each system will ship with gravel and Catalytic Carbon media. Pour the gravel in the tank first then pour in all the Katalox Light media that was shipped in the tank last. US Water does not ship "extra" media. Fill the Katalox tank with water and allow it to soak for at least 1 hour while the other components are installed. This will reduce the backwash/ rinse time needed to flush out the Katalox fines during the startup procedure. Katalox must be flushed until the pH of the water is below 8.8 S.U. This is done during the startup procedure.

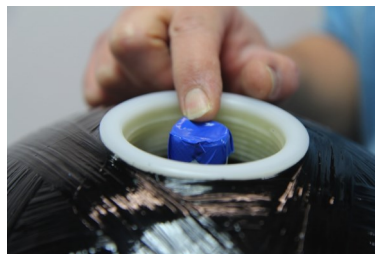

Superfilter Tank and Control Valve Preparation

2. Lubricate the distributor O-ring and the tank O-ring. Then install the upper basket (may look different than the pictures below) on the bottom of the valve by lining up the tabs then turning the basket clockwise to lock it in place. Place the upper basket over the distributor tube and push the valve on the tank. Thread the valve on the tank by turning it clockwise. Be sure not to cross-thread the valve on the tank. Tighten the valve hand tight, then snug it further by tapping it with the palm of the hand. **DO NOT** use tools to tighten the valve or damage could occur. Move the carbon unit to the side and start the injection panel installation



20 Micron Sediment Filter Installation Instructions

1. Install the 20 Micron sediment filter after the well pressure tank. The sediment filter is marked "IN" and "OUT" on the top of the housing.

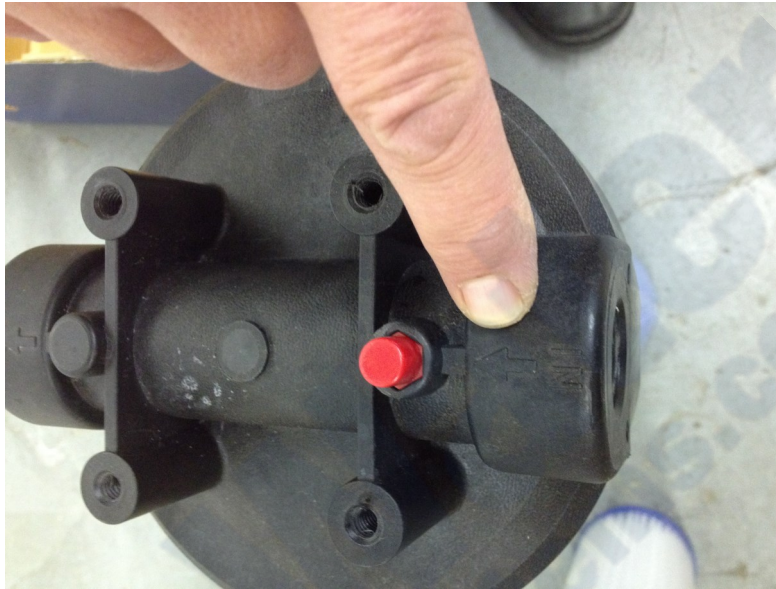

2. Mount the housing to the bracket using the supplied screws.



Sediment Filter Installation Instructions

3. Now mount the filter housing to the wall using the appropriate fasteners for your wall material. It is preferred that this is mounted on a secured board or wall stud as it will be heavy when full of water.



4. The outlet plumbing from the well pressure tank will connect to the "IN" port on the filter housing. The outlet plumbing from the sediment filter housing will be connected to the Fusion Superfilter inlet.



Sediment Filter Installation Instructions

1. Now install the filter in the filter housing by removing the sump from the housing.
2. There is a notch in the bottom of the sump that will center the filter in the housing. Unwrap the filter (20 Micron) and install it in the sump.



3. Coat the O-ring and threads on the sump with food grade silicone grease and install the O-ring in the filter sump.

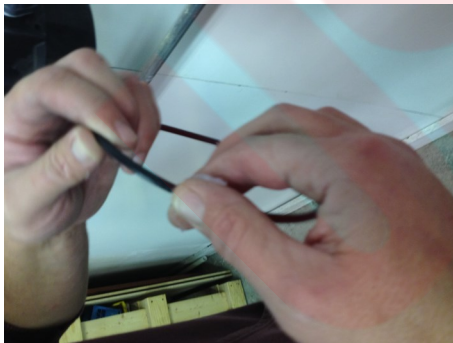

Sediment Filter Installation Instructions

4. Now install the sump in the filter cap and turn it clockwise to tighten the filter. Once it is hand tight, use the supplied wrench to tighten it an additional 1/4-1/2 turn.

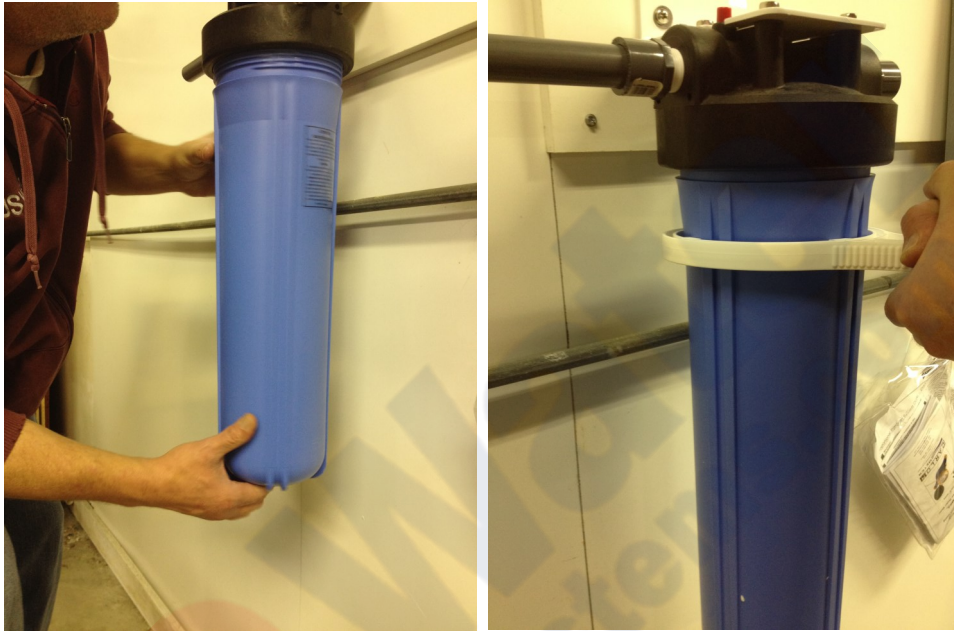

5. Once the filter is installed the red button on the top of the filter can be used to bleed the air out of the chamber when the water is turned on to the system (this step will be discussed during the startup procedure).



Superfilter Katalox Tank Installation Instructions

Any solder joints being soldered near the valve must be done before connecting any piping to the valves. Always leave at least 6" (152 mm) between the control valve and joints being soldered when soldering pipes that are connected to the valves. Failure to do this could cause damage to the valves.

The Fusion Backwashing Filter is equipped with 1" or 3/4" MPT removable connectors. It is recommended that these connectors are installed in the plumbing fitting using Teflon tape then lubricate the o-ring on the connector. Remove the red clips and push the connectors into the bypass valve once they are tight in the plumbing fitting. The red clips can then be re-installed to secure the connectors in the bypass valve.

The inlet and outlet can be identified on the bypass valve. There are arrows stamped in the bypass valve showing flow direction. The arrow pointing toward the valve is the inlet and the arrow pointing away from the valve is the outlet

1. Apply Teflon tape to the inlet connector and install the outlet pipe from the 20 micron filter to the inlet on the Superfilter control valve.



All piping should be secured to prevent stress on the bypass valve and connectors.

Superfilter Katalox Tank Installation Instructions

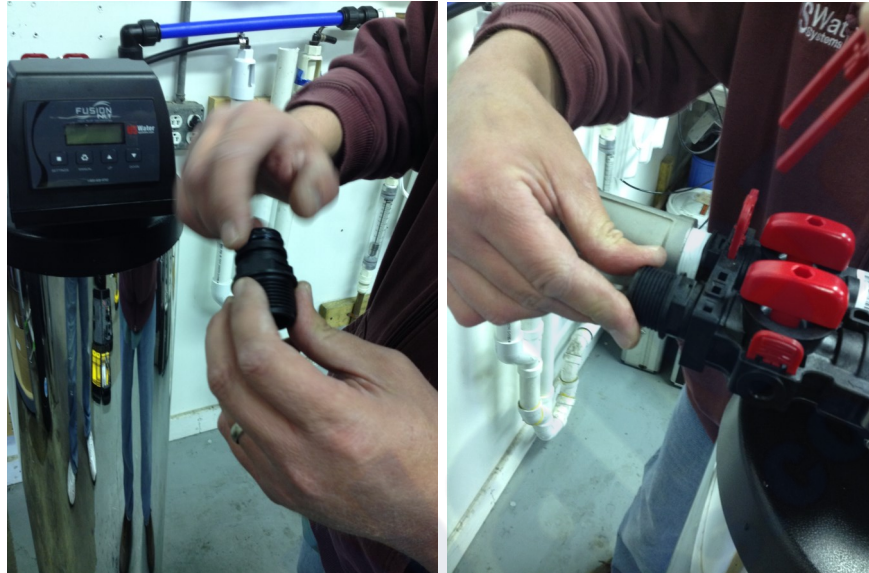

2. Attach the outlet plumbing from the Superfilter control valve to the “IN” port on the 5 micron filter. Be sure to check the stamped arrows on the valve and bypass for inlet/outlet orientation. **NOTE: Put the Fusion Katalox Superfilter in the bypass position.**

All piping should be secured to prevent stress on the bypass valve and connectors.

3. Install the drain line on the control valve. Be sure to use a hose clamp to secure the drain line to the barbed fitting on the control valve.



5 Micron Sediment Filter Installation Instructions

1. Install the 5 Micron sediment filter after the Fusion Katalox Superfilter. The sediment filter is marked "IN" and "OUT" on the top of the housing.

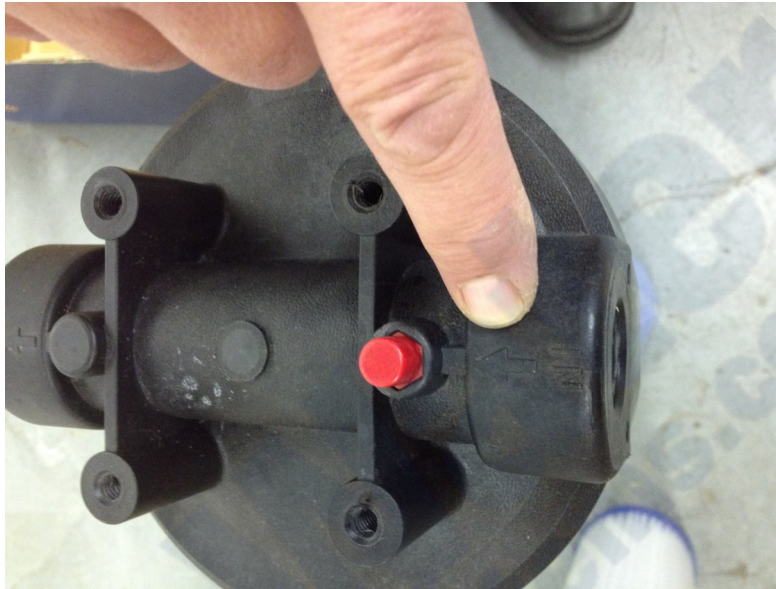

2. Mount the housing to the bracket using the supplied screws.



Sediment Filter Installation Instructions

3. Now mount the filter housing to the wall using the appropriate fasteners for your wall material. It is preferred that this is mounted on a secured board or wall stud as it will be heavy when full of water.



4. The outlet plumbing from the Fusion Katalox Superfilter will connect to the "IN" port on the filter housing. The outlet plumbing from the sediment filter housing will be connected to the GreenWave tank "UPFLOW" inlet.



Sediment Filter Installation Instructions

1. Now install the filter in the filter housing by removing the sump from the housing.
2. There is a notch in the bottom of the sump that will center the filter in the housing. Unwrap the filter (5 Micron) and install it in the sump.



3. Coat the O-ring and threads on the sump with food grade silicone grease and install the O-ring in the filter sump.



Sediment Filter Installation Instructions

4. Now install the sump in the filter cap and turn it clockwise to tighten the filter. Once it is hand tight, use the supplied wrench to tighten it an additional 1/4-1/2 turn.

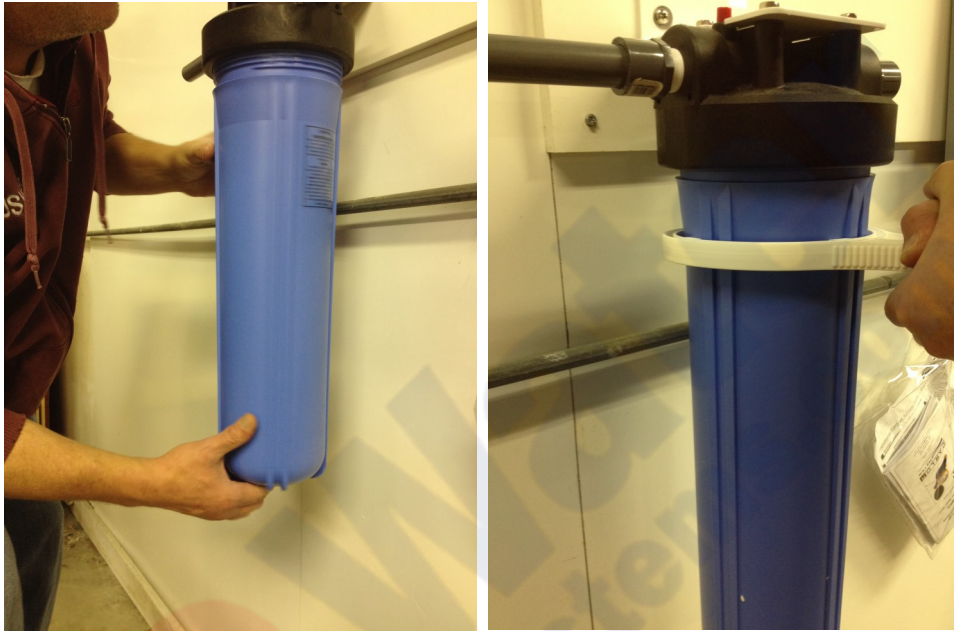

5. Once the filter is installed the red button on the top of the filter can be used to bleed the air out of the chamber when the water is turned on to the system (this step will be discussed during the startup procedure).



GreenWave Tank Installation Instructions



1. Place the GreenWave tanks in the desired location on a flat level surface.
2. Make sure that the tank head is tightened securely by hand tightening—Do Not Use a Wrench. Hand-tight is recommended.
3. Connect the outlet of the 5 Micron sediment filter to the upflow inlet of the GreenWave tank. **NOTE: Put the GreenWave tank in the bypass position (see below). The GreenWave tank operates in the UPFLOW mode which is opposite of most water softeners. Therefore, the inlet is labeled *upflow inlet* and the outlet is labeled *downflow inlet*.** Be sure to plumb the outlet plumbing from the 5 Micron sediment filter to the “UPFLOW” inlet.
4. Connect the outlet (marked “DOWNFLOW” inlet) plumbing from the GreenWave tank to the inlet on the US Water UV light.

Service Position
down-flow tank

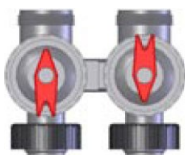

As shipped, the bypass is set-up for down-flow use. The arrow shape of the handles points in the wrong direction for UP-flow use. To convert it to UP-flow use, pull up on the red handles until they come off. Rotate the handle 180° and put it back on the valve stem.

Service Position
UP-flow tank

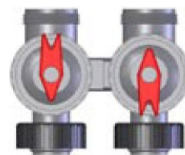

Bypass Position
UP-flow tank

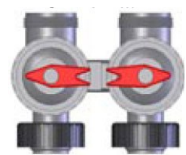

US Water UV Light Installation Instructions Overview



Figure 3. Recommended Installation

US Water UV Light Installation Instructions

Installation

Step 1: The UV disinfection system should always be the last piece of treatment before the water branches off to the hot and cold water lines if the intent is for Point of Entry (POE) (see figure 2). If the intent for the UV system is for Point of Use (POU) the system should be the final step before the faucet.

Step 2: US Water Systems strongly recommends that a 5 micron filter be installed **before** the UV system for a final polishing step before the water is disinfected.

Step 3: The reactor can be installed either horizontally or vertically using the clamps provided, however vertical installation is the preferred method with the inlet at the bottom (lamp connection at the top) as it allows any air that may be in the lines to be easily purged from the system.

Step 4: If the water supply flow rate is unknown, it is recommended that you use a flow restrictor so that the rated flow of your particular US Water Systems system is not exceeded and the UV dose is not compromised. The flow restrictor should be installed on the outlet port of the reactor.

Step 5: It is strongly recommended to have a licensed plumber connect the UV reactor to the water supply and may be a requirement depending on where you are located. If you are attempting this yourself, ensure you have all the necessary tools and fittings to accomplish this task.

Step 6: Although there are many methods of installation, this manual will provide a recommended procedure using copper plumbing and standard soldering methods. US Water Systems recommends the use of unions, a by-pass assembly and shut-off valves as this will allow you to isolate and remove the UV reactor if necessary (this method is a recommended method only however it allows for the maximum convenience but it requires extra components and more time for installation. Please refer to Figure 3 for the recommended installation.

Step 7: Before you cut into the cold water line, measure and cut all piping as per the recommended layout. Once all the components are ready, start by installing the female adapters onto the ports of the reactor. To ensure a proper seal, the use of Teflon™ tape is recommended on all threaded connections.

Step 8: Next solder all the assembly together, including ball valves and unions and finally connect the by-pass assembly to the cold water feed line (water in and water out).

US Water UV Light Installation Instructions

Step 9: You can now gently remove the quartz sleeve from its packaging being VERY careful not to touch the length with your hands. The use of cotton gloves (not included) is recommended for this procedure as oils from our hands can leave residue on the sleeve and lamp which can ultimately block the UV light from getting to the water. In the package, you will find a lubricated o-ring. Place the o-ring over the open-end of the sleeve as shown in Figure 4.



Figure 4. Quartz Sleeve Installation

Step 10: Carefully slide the sleeve into the reactor until you can feel it hit the opposite end of the reactor. Slightly push the sleeve in to feel it lock into the spring inside the reactor. Ensure that the o-ring is butted up against the reactor. Assemble the provided gland nut onto the threaded end of the reactor and tighten. The gland nut has a positive stop to avoid over-tightening, hand tighten ONLY. Install the provided stainless steel compression spring inside the quartz sleeve. This spring simply sits in the bottom of the quartz sleeve and works with the lamp and lamp connector to create the proper lamp alignment.
PLEASE NOTE: DO NOT install a UV lamp inside the quartz sleeve without the sleeve spring in place.

Step 11: (Applies only if you have a UV sensor¼ USWATER6.0) The UV sensor for the system is packaged in a separate plastic bag. Carefully remove the sensor from its packaging and insert the sensor into the UV sensor port (remove the protective cap on the UV reactor first). The sensor can only go in one way. Ensure that the flat portion of the UV sensor matches up with the half metal lip on the sensor port (flat portion should face the lamp connection end) (see Figure 5.). Ensure that the sensor is fully seated in the sensor port and then tighten (turning clockwise) the sensor nut.

PLEASE NOTE: DO NOT over tighten the nut as this could damage the Teflon sensor body. Plug the male connector into the IEP port located on the right side of the controller, Figure 6, (make sure the controller is not plugged in as the sensor MUST be attached before power is applied to the controller.)

US Water UV Light Installation Instructions

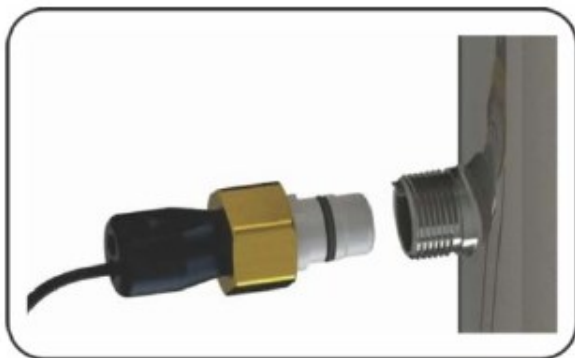

Figure 5. UV Sensor Installation



Figure 6. IEP Connection

Step 12: The reactor is now ready for water flow. When all plumbing connections have been completed you should check for any possible leaks. Slowly turn on the water supply and check for leaks. Make sure the by-pass valves are functioning properly and that the water is flowing through the reactor. The most common leak is from the o-ring not making a proper seal on the reactor. If this is the case turn the water off, drain the reactor, remove the o-ring, dry it and reapply silicon grease. Replace o-ring ensuring that it is properly sealed against the reactor and check again for leaks.

Step 13: The controller can now be mounted on the wall. The controller should always be above or beside the reactor to ensure that no moisture can deposit on any of the connections (see Figure 2.). Always mount the controller vertically. For safety purposes the controller should be connected to a ground fault circuit interrupter (GFCI) (also known as a ground fault interrupter (GFI)).

Step 14: You can now remove the UV lamp from its packaging being careful not to touch the lamp quartz with your hands. Again, the use of cotton gloves is recommended to avoid deposited oils on the lamp glass. Always hold the lamp by the ceramic ends. With the lamp outside of the reactor, affix the UV lamp to the lamp connector as shown in Figure 7.

US Water UV Light Installation Instructions

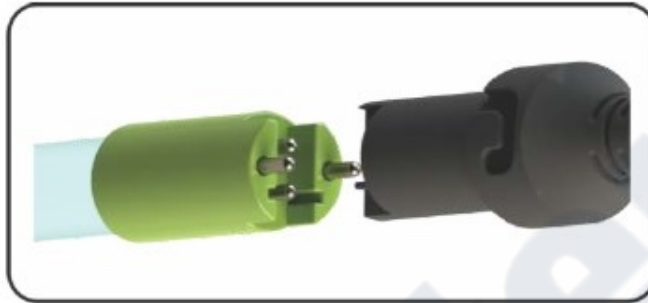

Figure 7. UV Lamp Connection

Step 15: Carefully insert the UV lamp into the reactor sliding it inside the quartz sleeve located inside the reactor (do not drop the lamp into the reactor). Affix the lamp connector into the gland nut by inserting the connector into the nut and turning the connector approximately $\frac{1}{4}$ turn to lock the connector to the gland nut.



Figure 8. Quick Disconnect Connector

Step 16: Affix the captive ground screw to the ground lug on the UV reactor to ensure proper grounding continuity.

US Water UV Light Installation Instructions

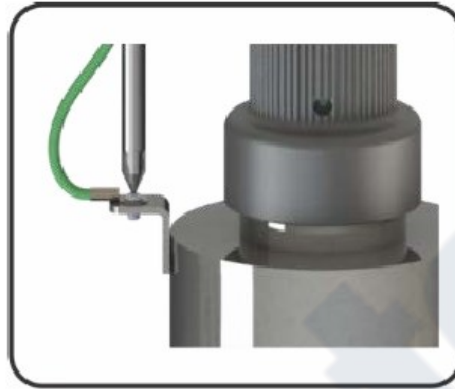

Figure 9. Ground Screw Connection

Step 17: Your system is now ready to be plugged into the appropriate GFCI protected outlet. The unit will be plugged in during the startup procedure. DO NOT plug in at this time.

1 Micron Sediment Filter Installation Instructions

1. Install the 1 Micron sediment filter after the US Water UV light. The sediment filter is marked “IN” and “OUT” on the top of the housing.



2. Mount the housing to the bracket using the supplied screws.

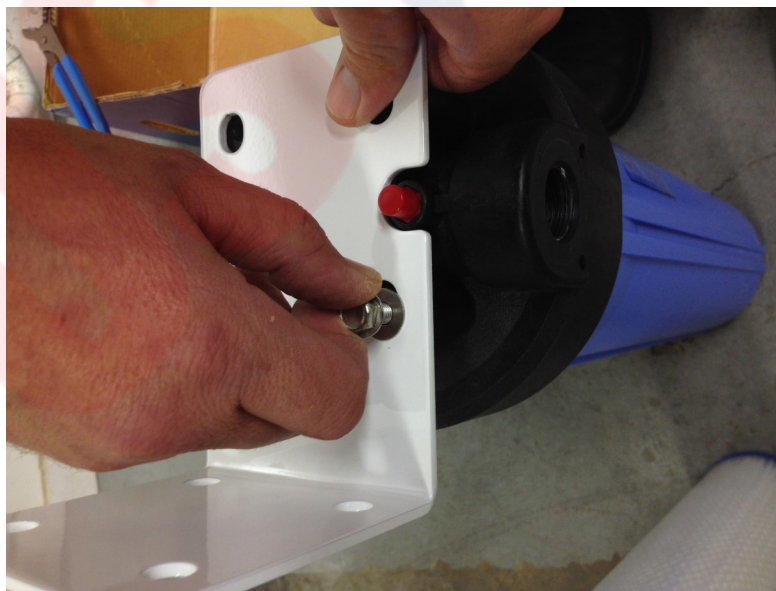

1 Micron Sediment Filter Installation Instructions

3. Now mount the filter housing to the wall using the appropriate fasteners for your wall material. It is preferred that this is mounted on a secured board or wall stud as it will be heavy when full of water.



4. The outlet plumbing from the UV light will connect to the “IN” port on the filter housing. The outlet plumbing from the sediment filter housing will be connected to the plumbing distribution system for the home.



1 Micron Sediment Filter Installation Instructions

1. Now install the filter in the filter housing by removing the sump from the housing.
2. There is a notch in the bottom of the sump that will center the filter in the housing. Unwrap the filter (1 Micron) and install it in the sump.



3. Coat the O-ring and threads on the sump with food grade silicone grease and install the O-ring in the filter sump.

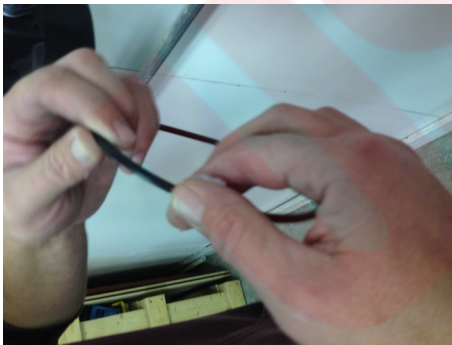

1 Micron Sediment Filter Installation Instructions

4. Now install the sump in the filter cap and turn it clockwise to tighten the filter. Once it is hand tight, use the supplied wrench to tighten it an additional 1/4-1/2 turn.

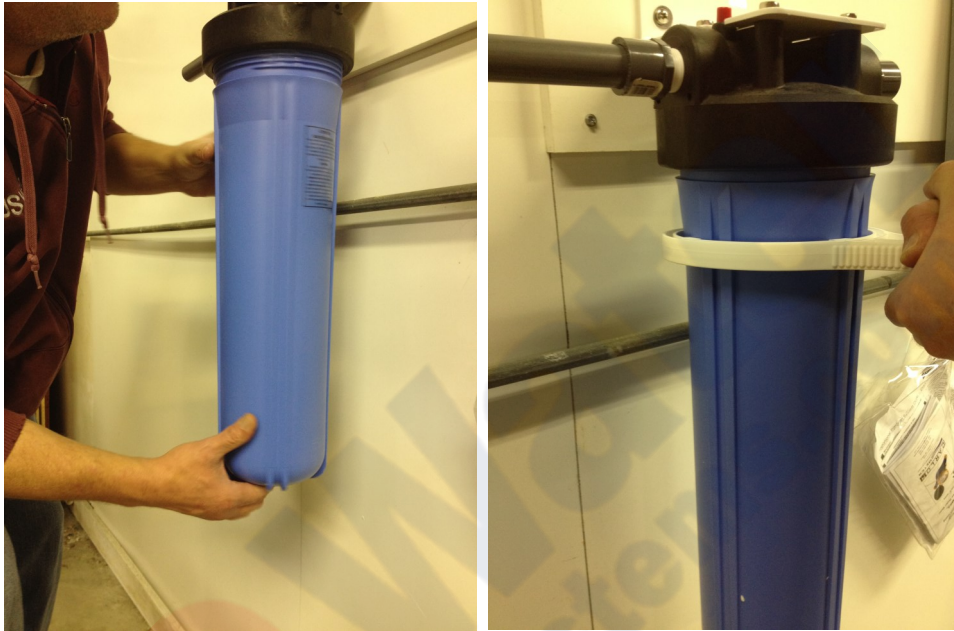

5. Once the filter is installed the red button on the top of the filter can be used to bleed the air out of the chamber when the water is turned on to the system (this step will be discussed during the startup procedure).



Fusion Carbon Superfilter Key Pad Configuration

SETTINGS This function is to enter the basic set up information required at the time of installation.

MANUAL REGEN This function is to initiate an immediate or delayed manual regeneration.

DOWN / UP Increase or decrease the value of the settings while in the programming mode.



Manual Backwash Initiation

DELAYED BACKWASH

Press and release the MANUAL REGEN. Button to set a delayed regeneration that will occur at the regeneration time. The main display page will show DELAYED REGEN ON. To cancel press and release the MANUAL REGEN. Button. The main display page will show DELAYED REGEN OFF.

IMMEDIATE BACKWASH

To start an immediate regeneration (or step valve through each position), press and hold the MANUAL REGEN. Button for 3 seconds (until beeps). The valve will start an immediate regeneration. Press any key to skip to the next cycle.

The “Gallons” function is not used in the system and the data shown on the valve parameters is not actual. This valve regenerates on a timed frequency and does not use water usage (gallons).

Superfilter Control Valve Programming Instructions

- 1) Plug in the control valve and press and hold the “Settings” button on the control valve to enter the programming mode. If the control valve is locked, press and hold the “Settings” button to unlock the valve, then press the “Settings” button again to enter the programming mode.
- 2) When in the programming mode there will be a black cursor that appears over the value. The “UP” and “DOWN” arrows can be used to change the value. Once the value is set, the “Settings” button can be pushed to save the setting and move to the next parameter.
- 3) Set the “Time of Day” and the “Date”.
- 4) Set the “Regen Days” to “2” for every two days. This MUST not be deviated.
- 5) The “Gallons” parameter should be set to “Off”.**
- 6) The “Regeneration Time” should be set to around 2-3 hours after bedtime to ensure the system is not regenerating during usage hours. If there is other backwashing/regenerating equipment be sure to offset the regeneration/backwash times of each of those units so each unit can backwash/regenerate independently.

Settings

Press SETTINGS key (3 SECONDS / BEEP)

VALVE MODE
B.W. FILTER

TIME OF DAY
12:01 PM

YEAR
2012

MONTH
AUGUST

DAY
21

REGEN DAYS
3 DAYS

GALLONS
OFF

REGEN TIME
12:00 AM

PROGRAMMING
COMPLETE

TIME OF DAY, YEAR, MONTH, DAY,

Time of day is for normal operation of system and the scheduling of the regeneration time. The date is used in a diagnostic function to track the last time the system regenerated.

REGEN DAYS

This value is the number of days between regenerations or back washes to clean the filters.

GALLONS

Default value is OFF. This should not be changed.

REGEN TIME

This setting determines the time of day to perform a scheduled regeneration. The normal regen time for a filter is 12:00 AM.

System Start-up Instructions

1. Once all the plumbing has been connected, slowly open the main water shutoff valve. Open a spigot downstream of the entire system to release the air. Run the water through the system plumbing. The Fusion Katalox Superfilter and GreenWave tanks will be in the bypass position.
2. Once the air is out of the plumbing, close the downstream spigot and let the plumbing system pressurize. Check all the plumbing connections for leaks. If there are leaks fix them immediately. Especially around the electronic components.
3. Now push the red button on the top of the 20 micron, then the 5 micron and finally the 1 micron filter housings and bleed the air until water is coming out of the red button on each filter.



4. Plug the Superfilter valve into an approved power source that is constantly energized.
5. When power is supplied to the control valve, the screen will display "INITIALIZING WAIT PLEASE" while it finds the service position.
6. Once the valve has settled on the time of day, start an Immediate Manual Regeneration (See page 30). The valve will immediately start moving to the BACKWASH position.
7. Open the inlet on the bypass valve slowly and allow water to enter the unit. Allow all air to escape from the unit before turning the water on completely. Air will be pushed out of the drain line when the Superfilter is in the backwash cycle. Be sure to secure the drain line because the air and water will be moving through the drain line with force. Once the valve is in the backwash position, unplug the power to the unit. This will keep the unit in backwash. Let the filter backwash for 1 hour minimum, then plug the unit back in the outlet. The unit will then continue with the backwash cycle.
8. When the backwash cycle is complete the valve will advance to the RINSE position. Check the drain line flow. Allow the water to run for the entire RINSE cycle until the water is clear. You may see some bubbles in the water but there should be no bursts of air coming out of the Superfilter.
9. The valve will automatically advance to the SERVICE position after the RINSE cycle is complete. Open the outlet valve on the control valve bypass, then open the nearest treated water faucet and allow the water to run until clear, close the tap and replace the faucet screen. Check the pH level. If it is still above 9 S. U., backwash the unit again.
10. Program time, date, and number of days between regenerations into controller using Programming Instructions.

GreenWave Tank Startup Instructions

WARNING! Be sure the peroxide injection pump is adjusted properly before bringing the GreenWave tank into service. Iron or other contaminants that are removed by the peroxide injection system can damage the GreenWave media. It is crucial that the peroxide system is operating properly.

1. The GreenWave tank should be in “bypass” - shown below.
2. Open a spigot downstream of the system and slowly open both bypass valves on the GreenWave tank. Just slightly open the valves at first and let the air start to purge from that tank. **WARNING! Do not open the valves completely until the air is purged from the GreenWave tank or damage could occur.**
3. Run the water for several minutes or until clear and the air has been purged from the GreenWave tank and the entire system. Then fully open the bypass valves on the GreenWave tank.
4. Confirm that there are no leaks and plug the US Water UV light into the 110v GFI outlet.
5. The system is now operational and the startup is complete.

**Bypass
Position
UP-Flow Tank**

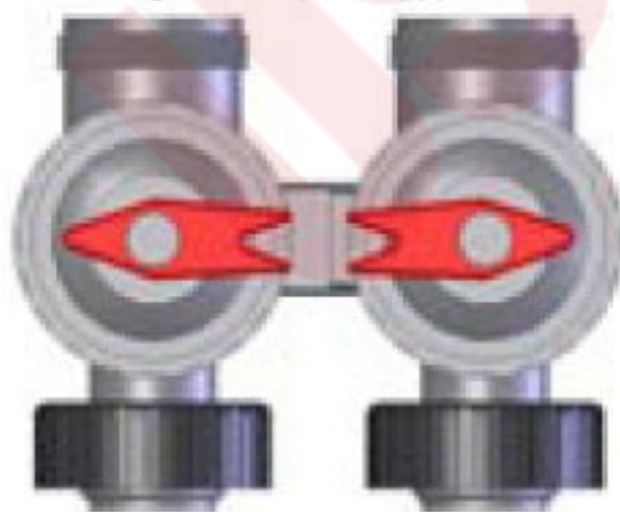

**Service
Position
UP-Flow Tank**

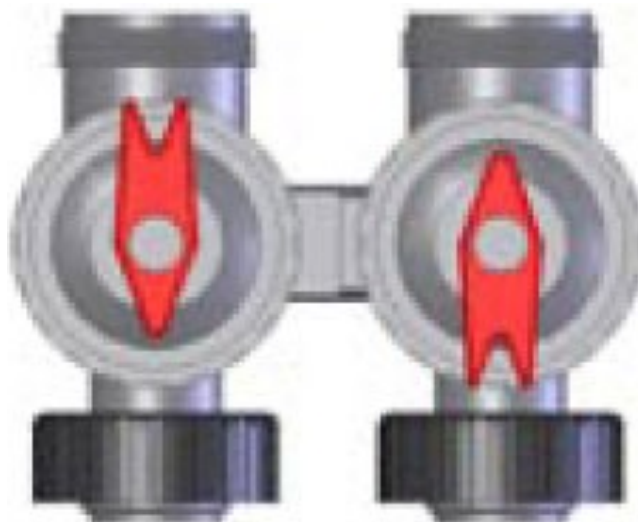

What to Expect

1. The GreenWave Fusion system will produce iron, sulfur, manganese removal with scale free water immediately after installation. Depending on the raw water quality there may be contaminants built up in the water heater, plumbing system and other devices. Over the first few weeks as water is used there could be traces of this build up that are being removed by the newly installed system. This typically clears up after a couple weeks.
2. Depending on the contaminants being removed there may be iron bacteria or sulfur reducing bacteria in the plumbing system prior to the GreenWave Fusion install. This bacteria can potentially survive after the GreenWave Fusion installation. This is usually indicated by a sulfur smell that will appear after a few weeks of initial usage. If this is the case, the well and entire plumbing system will need to be chlorinated to remove any existing bacteria. If the bacteria is not removed, it will begin to “grow” backwards toward the treatment system and the sulfur smell will not go away. If this does occur, it is easily eradicated with a chlorination well “shock” procedure. Ask a US Water Systems representative about our well sanitizing kits. **WARNING!** If a well is being chlorinated, the GreenWave tank should be in the bypass position or damage to the media will occur.

Routine Maintenance

Sediment Filters

Clean or replace the sediment filter every 6-12 months. If there is smell in the raw water, it is best to replace the filters as cleaning usually doesn't prevent the smell from returning. A dirty sediment filter can hold contamination and contribute to a smell in the treated water.

Katalox Light Superfilter

The Katalox Light Superfilter is virtually maintenance free. However, if there is a power outage the clock and other settings need to be checked to ensure the filter will backwash properly at the proper time of day. It is crucial that the Katalox Light Superfilter backwashes at a time when there is no water being used in the house or contamination of the plumbing system can occur.

GreenWave Tank

The media in the GreenWave tank will need to be changed every 3-5 years. The performance can be tested using the “boil test” method on page 35 of this manual.

US Water UV Light

The UV light sleeve and bulb combo should be changed every 9000 hours or annually.

Boil Test

The GreenWave tank media can be checked by using the following boil test method. The GreenWave tank cannot be checked by using a hardness test because the elements that make up hardness will still be present in the water. A hardness test will always show hardness because the GreenWave tank does not remove hardness, it only isolates it and prevents it from scaling.

1. Fill a pan with about 1” of treated water.
2. Bring the water to a boil and allow it to boil violently until all the water has evaporated.
3. Immediately remove the pan from the stove when the last bit of water is evaporated and allow it to cool.
4. The residual solids in the pan should wipe out easily with a wet cloth.

If the residual solids will not wipe out easily with a wet cloth, the media may need to be replaced.

Maintenance Schedule

Component	Action	Frequency
Existing Well Pressure Tank	Drain tank until the water runs clear.	1-6 Months
Big Blue Sediment Filters	Clean or replace (These filters can cause odors in the water if not replaced or cleaned regularly. The filters should be changed if the filter media is discolored).	6-12 Months
Fusion Superfilter Tank	Check the clock and settings periodically or after a power outage.	Monthly
Fusion Superfilter Tank	Replace the Katalox Light media.	1-15 Years (dependent on the water usage and contaminant level being treated)
GreenWave Tank	Check the performance of the GreenWave tank using the "boil test". Replace the media as necessary.	3-5 Years
US Water UV Light	Replace the US Water UV light sleeve and bulb combo every 9000 hours or annually. Refer to the US Water UV light manual for bulb replacement instructions.	Annually



GreenWave
Fusion

Warranty

For the lifetime of the original purchaser, at the original residential place of installation of this *GreenWave Fusion* Water Conditioning System, *US WATER SYSTEMS, INC.* warrants the following:

LIFETIME COVERAGE

Media Tank

Free of all costs to you except transportation and labor charges, we warrant that we will replace or repair the fiberglass media tank, if for any reason it is found to be defective, because of faulty materials or workmanship.

FIVE YEAR COVERAGE

Valve Assembly & Electronics

We warrant that for five (5) years from the date of purchase, we will replace the valve assemblies or electronic components at no charge to you except for transportation and standard labor charges. Electronics damaged due to environmental issues or improper installation are not covered.

TWO YEAR COVERAGE

We warrant that if the GreenWave media fails within 2 years of installation, it will be replaced 100% at no cost to you. If the GreenWave media fails 3-5 years after installation 50% of the cost will be covered for media replacement. Media that is damaged due to neglect will not be covered. The iron treatment system must be maintained properly to ensure warrant coverage.

GENERAL PROVISIONS

This warranty does not apply to any commercial or industrial installations or to any part of the water conditioner which has been subjected to misuse, neglect, alteration or accident; or to any damage caused by fire, flood, freezing, Acts of God, or any other casualty, or if the original serial numbers have been removed.

These warranties are in lieu of all other warranties expressed, or implied, and we do not authorize any person to assume for us any other obligation on the sale of this water conditioner. No responsibility is assumed for delays or failure to meet these warranties caused by strike, government regulations or other circumstances beyond the control of *US WATER SYSTEMS, INC.*

TO OBTAIN WARRANTY SERVICE, CALL OR WRITE: *US WATER SYSTEMS, INC. 1209 COUNTRY CLUB ROAD INDIANAPOLIS, IN 46234 (800) 608-USWA.*

ANY IMPLIED WARRANTIES OF FITNESS OR MERCHANTABILITY ARE LIMITED TO THE TERMS OF THIS EXPRESSED WARRANTY AND THERE ARE NO WARRANTIES WHICH EXTEND BEYOND THOSE HEREIN. *US WATER* SHALL NOT BE LIABLE FOR ANY INCIDENTAL OR CONSEQUENTIAL DAMAGES.

SOME STATES DO NOT ALLOW THE EXCLUSION OR LIMITATIONS OF INCIDENTAL OR CONSEQUENTIAL DAMAGES SO THE ABOVE LIMITATION MAY NOT APPLY TO YOU. THIS WARRANTY GIVES YOU SPECIFIC LEGAL RIGHTS, AND YOU MAY ALSO HAVE OTHER RIGHTS WHICH VARY FROM STATE TO STATE.

THIS WARRANTY MAY BE TRANSFERRED TO A SUBSEQUENT OWNER WITH WRITTEN APPROVAL OF *US WATER* AND PAYMENT OF STANDARD TRANSFER FEE.



US Water
systems.com