

2" CARBON FILTER

MODEL NO. 140-31F-GAC-10

FLOW RATE:
 PEAK 28 GPM.
 BACKWASH 30 GPM.

TANK SIZE: 24" x 72"
 COMPOSITE

MEDIA:
 CARBON 10 cu. ft.
 GRAVEL 250 lbs.

PIPE SIZE"
 INLET 2"
 OUTLET 2"
 DRAIN 2"

WEIGHT (APPROX)
 TOTAL SHIPPING 806 lbs.

SPACE REQUIRED (APPROX)
 24" L x 24" W x 85" H

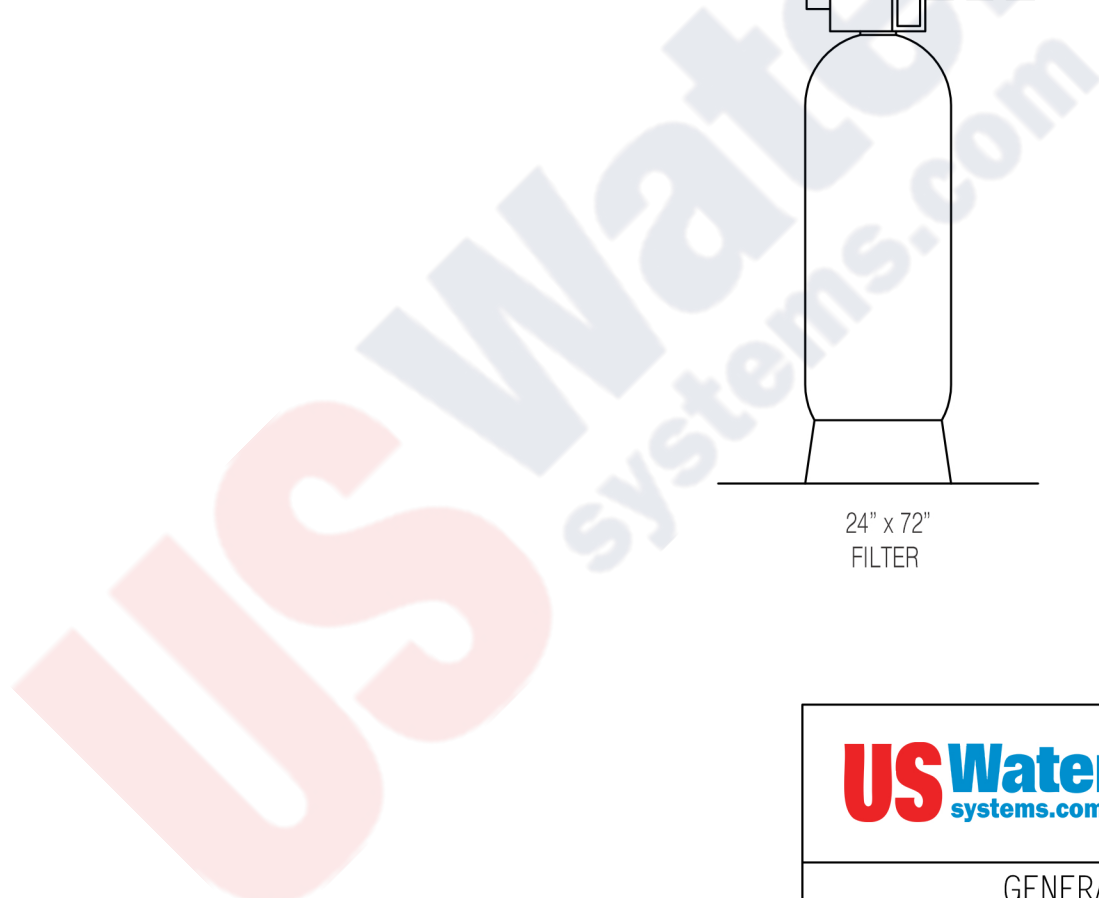
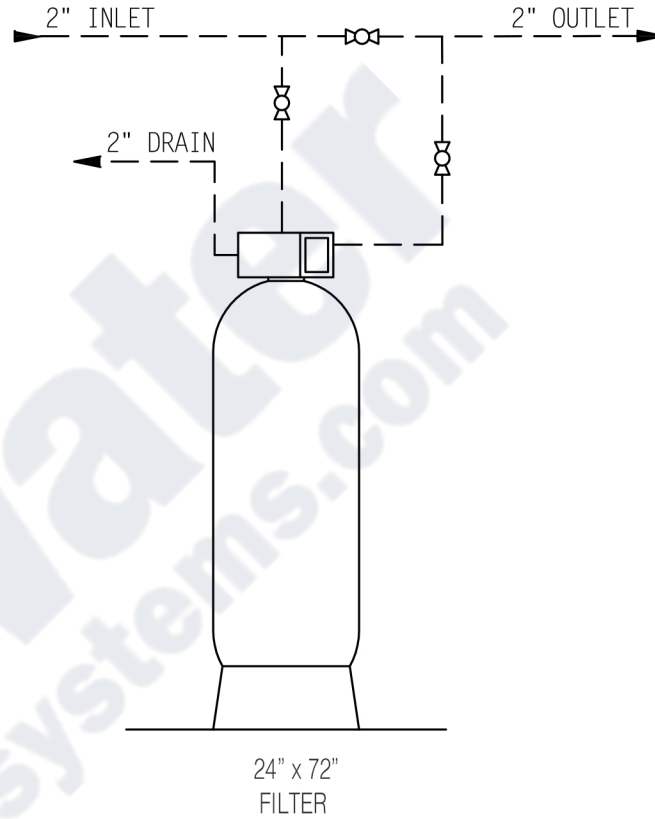

NOTE:
 ALL DASHED PIPE, VALVES,
 AND FITTINGS NOT PROVIDED
 BY US WATER SYSTEMS

DO NOT SCALE DRAWING

THIS DRAWING IS ISSUED IN CONFIDENCE AND CANNOT BE REPRODUCED OR USED TO MANUFACTURE ANYTHING SHOWN OR REFERRED TO WITHOUT DIRECT WRITTEN PERMISSION FROM US WATER SYSTEMS

		US Water Systems 1209 Country Club Road Indianapolis, IN 46234 1-800-608-8792 www.USWaterSystems.com	
GENERAL ARRANGEMENT DWG. FILTER SIMPLEX SYSTEM TIMELOCK			
DRAWN BY: DATE: CHECKED BY: PAGE 1 OF 1	_____ _____ _____ _____	DWG. NO. 140-31F-GAC-10	