

2" CATALYTIC CARBON FILTER

MODEL NO. 140-31F-CAT-15

FLOW RATE:

PEAK 44 GPM.
 BACKWASH 55 GPM.

TANK SIZE: 30" x 72"
 COMPOSITE

MEDIA:
 CATALYTIC CARBON 15 cu. ft.
 GRAVEL 350 lbs.

PIPE SIZE"
 INLET 2"
 OUTLET 2"
 DRAIN 2"

WEIGHT (APPROX)
 TOTAL SHIPPING 1100 lbs.

SPACE REQUIRED (APPROX)
 30" L x 30" W x 90" H

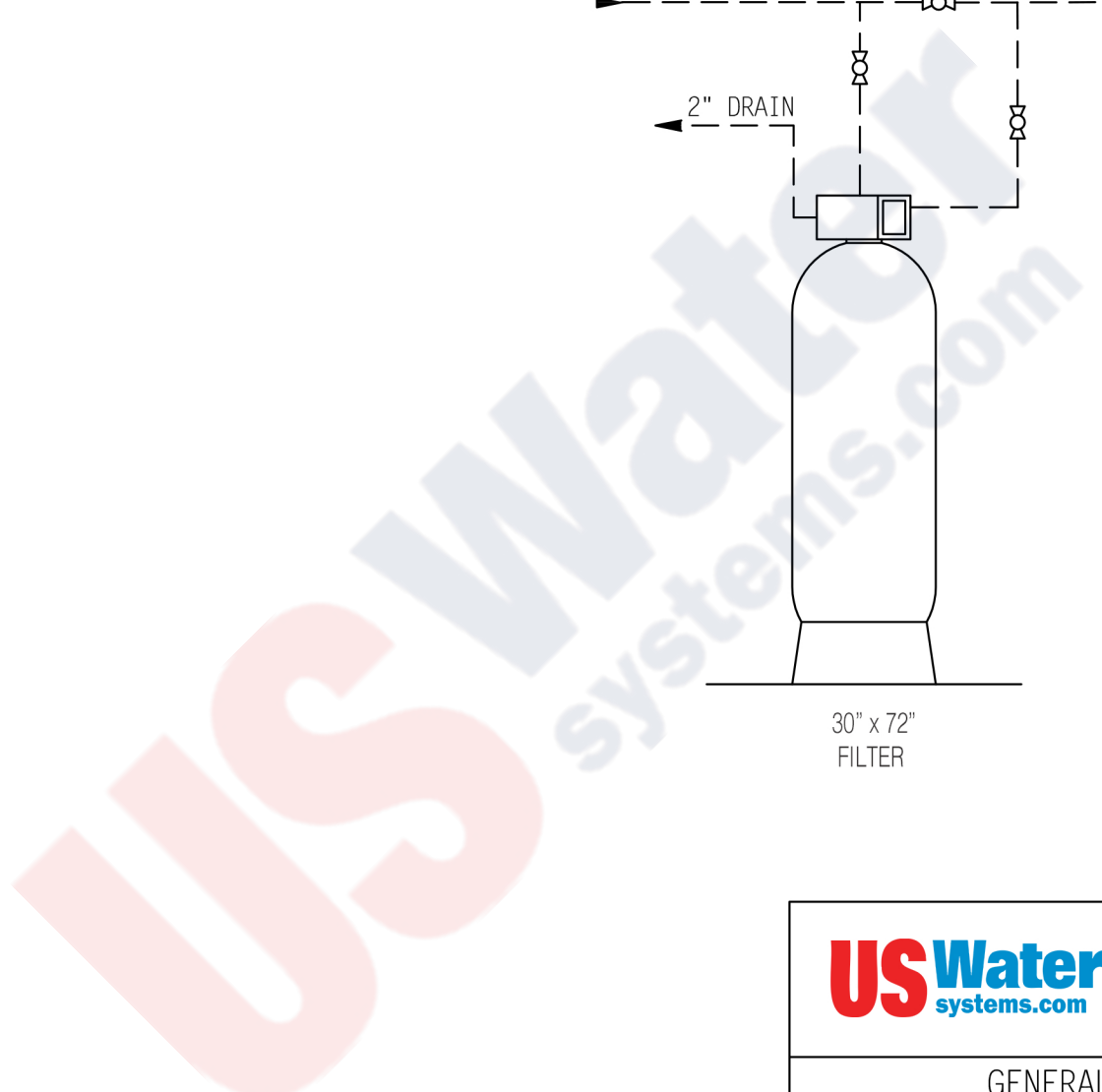
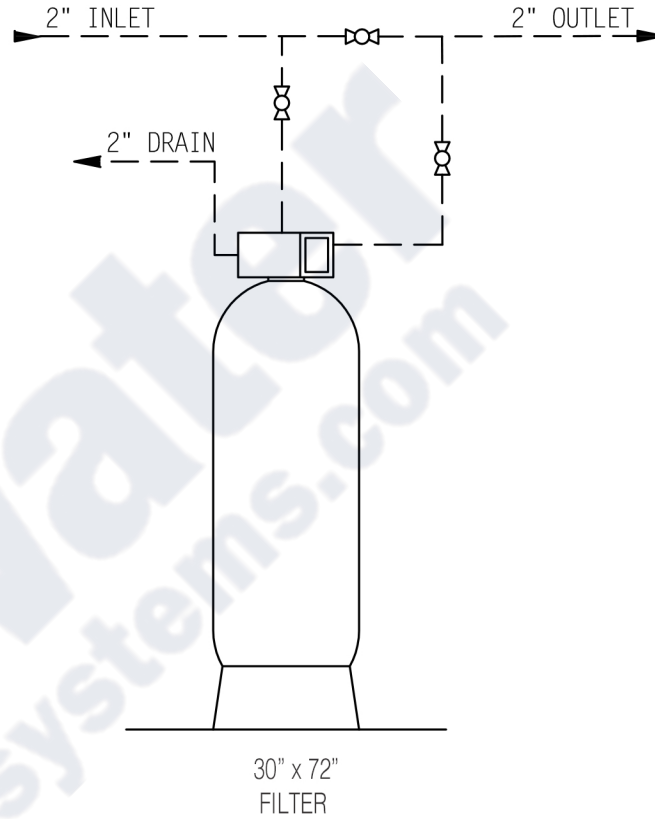

NOTE:
 ALL DASHED PIPE, VALVES,
 AND FITTINGS NOT PROVIDED
 BY US WATER SYSTEMS

DO NOT SCALE DRAWING

THIS DRAWING IS ISSUED IN CONFIDENCE AND CANNOT BE REPRODUCED OR USED TO MANUFACTURE ANYTHING SHOWN OR REFERRED TO WITHOUT DIRECT WRITTEN PERMISSION FROM US WATER SYSTEMS

		US Water Systems 1209 Country Club Road Indianapolis, IN 46234 1-800-608-8792 www.USWaterSystems.com
GENERAL ARRANGEMENT DWG. FILTER SIMPLEX SYSTEM TIMELOCK		
DRAWN BY: DATE: CHECKED BY: PAGE 1 OF 1	_____ _____ _____ _____	DWG. NO. 140-31F-CAT-15