



SUPERPRO[®]

Chimney Catalog

FUEL TYPE: GAS | OIL | WOOD | COAL
US ONLY



Typical Installation	3
Technical Data Sheet	4
Stainless Steel Chimney lengths.....	5
Adjustable Chimney Lengths	6
Stainless Steel Elbows	7-8
Tee Components	9
Supports	10-11
Shields.....	12
Flashings and Storm Collars	13-14
Premium Rain Caps	15
Parts and Accessories	16-17
Fireplace Parts	18
Support Kits.....	19

Typical Installation

CEILING SUPPORT INSTALLATIONS

One Story



Two Story

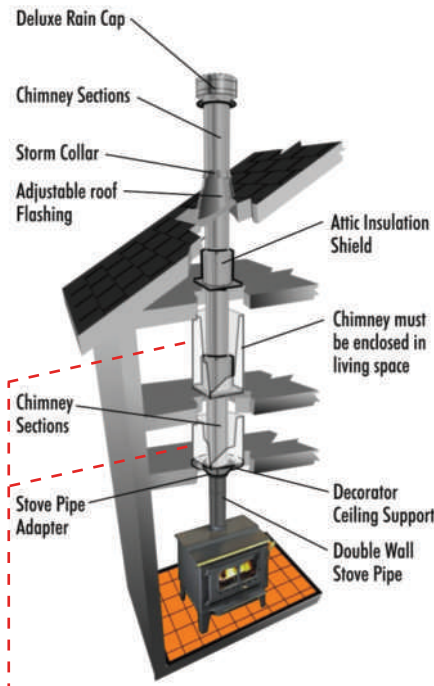

Elbow Installation

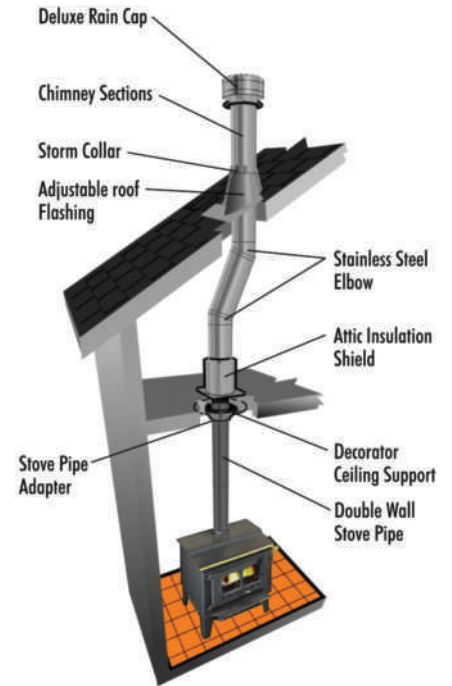

- NOTE: An installation in Canada will require a Supplemental Radiation Shield where the chimney system is enclosed in living or attic spaces

CEILING SUPPORT INSTALLATIONS

With Square Ceiling/Cathedral Support

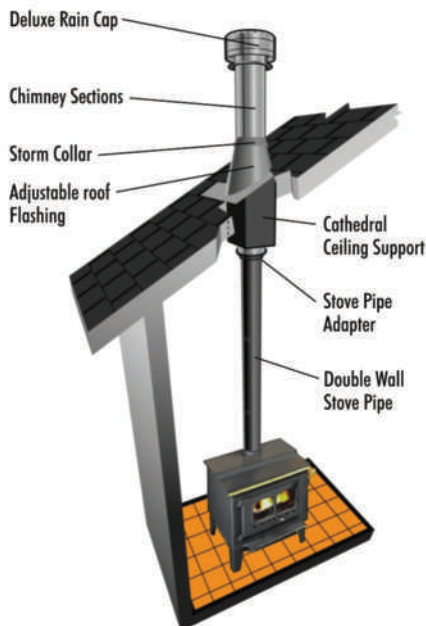

WALL SUPPORT INSTALLATIONS

One Story

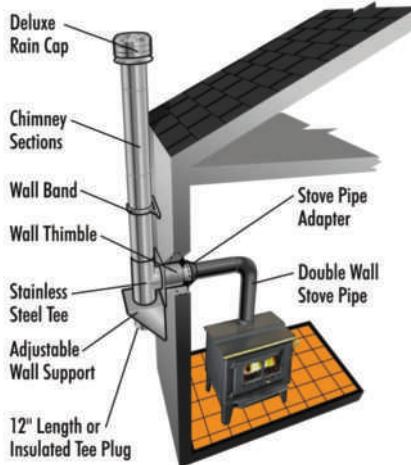

Through a Soffit

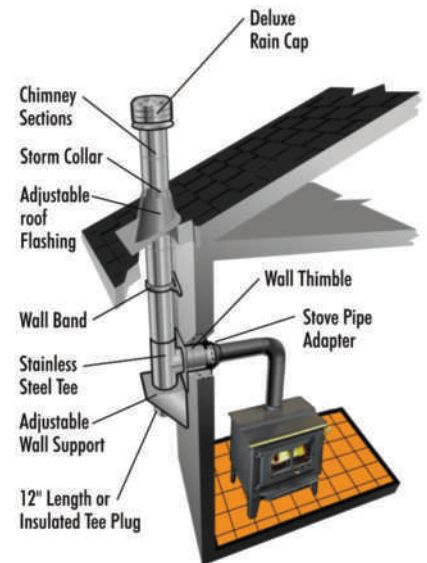

USE USP STOVE PIPE FOR OPTIMUM SYSTEM PERFORMANCE

Note: Technical data, photographs, drawings and installations may vary and are for reference only. Actual installations must be conducted according to the data and drawings shown in the installation instructions.

SUPERPRO.

TECHNICAL DATA SHEET

FOR THE CHIMNEY PROFESSIONAL WHO DEMANDS THE BEST...

SuperPro incorporates the latest technology in factory-built chimney design; providing superior performance, durability, and safety. SuperPro is designed to accompany today's appliances, which are engineered to produce low emissions and high heat. This makes SuperPro the choice of professionals who are looking for a better-quality, factory built chimney system.

CERTIFICATION & APPLICATIONS

SuperPro is Safety Tested and Listed to applicable UL/ULC Standards. These include:

Canada: ULC S-604

Safety Standard for chimneys serving liquid/gas fuel appliances

This chimney system may be used on appliances that burn Oil or Gas. SuperPro Model SPR may also be used with specific listed factory-built fireplaces listed to UL 127 or ULC-S610.

USA: UL 103-HT

Safety Standards for chimneys serving solid fuel and liquid fuel appliances. This chimney system has been designed for use on wood stoves, fireplaces and residential furnaces in the U. S. market.

Allowable Flue Gas Temperatures are:

Maximum Continuous	1000° F / 540° C
Brief Forced Firing	1400° F / 760° C (60 min.)
Creosote Burn Out	2100° F / 1150° C (3 x 10 min.)

SMART CHOICE LIFETIME WARRANTY

The SuperPro Smart Choice Lifetime Warranty applies to all Chimney components (not just insulated lengths) making SuperPro chimney the smart choice, every time. (See written Warranty for details).

ENHANCED FEATURES

Premium Grade Stainless Steel construction of both the inner liner and outer casing make SuperPro chimney extremely corrosion resistant. Embossed couplers do not allow moisture to penetrate the chimney's outer wall. Sections simply 'twist-lock' together and may be secured with optional Locking Bands. The SuperPro product line features **Deluxe Chimney Support Components** that will enhance any installation.

SUPPORTS/FRAMING

All SuperPro Supports are designed to carry four times the combined weight of each system at maximum allowable height.

Support and Framing Dimensions Table

Support	Ceiling Support	Wall Support	Cath. Ceiling Support	Roof Support
	50'	38'	38'	50'
Diameter	Framing Dimensions			
5" Dia.	11-3/8" x 11-3/8"	14-3/8" x 14-3/8"	11" x 11"	11" x 11"
6" Dia.	12-3/8" x 12-3/8"	14-3/8" x 14-3/8"	12" x 12"	12" x 12"
7" Dia.	13-3/8" x 13-3/8"	14-3/8" x 14-3/8"	13" x 13"	13" x 13"
8" Dia.	14-3/8" x 14-3/8"	14-3/8" x 14-3/8"	14" x 14"	14" x 14"

CONSTRUCTION

Inner Liner (Flue):	Premium Grade Stainless Steel 0.016" thickness
Outer Casing:	Premium Grade Stainless Steel 0.016" thickness

Note: All SuperPro Twist-Lock Couplers are embossed (not lanced) and seams are weather-proofed to prevent moisture from entering the chimney.

Insulation: The 1" space between the inner/outer walls is Solid Packed with Mineral Wool Fibre insulation to provide superior insulating qualities, in a "slim-line" design. Solid Pack design performs favorably to Blanket type and Air-Cooled chimney designs.

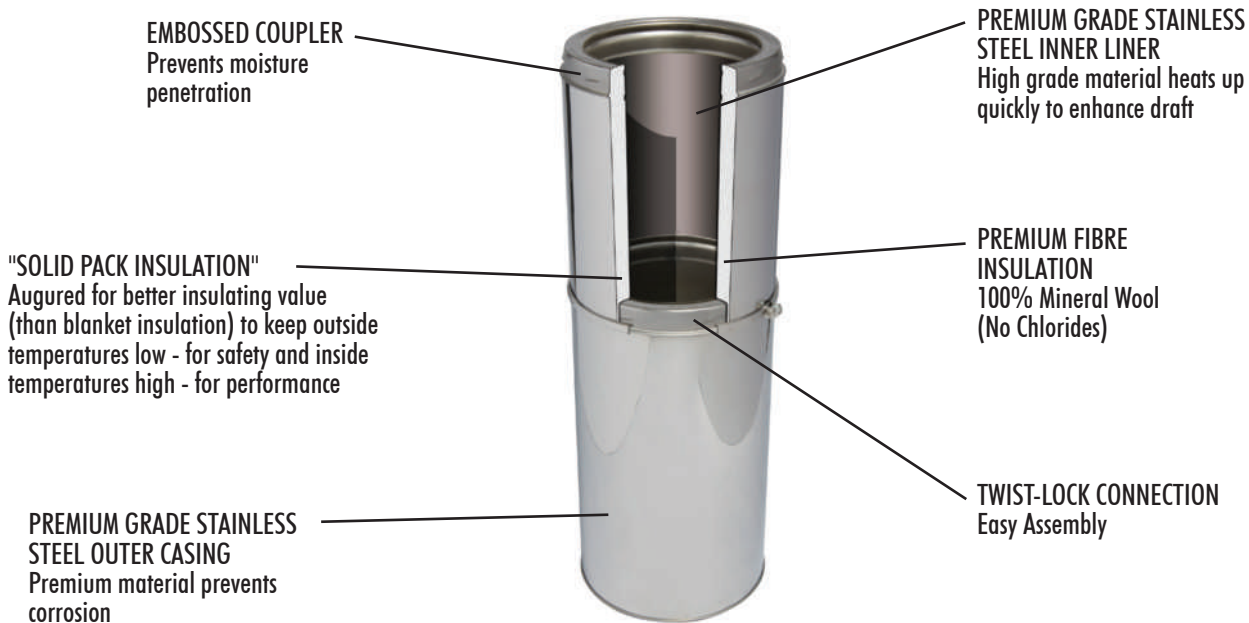

The Best Warranty in the Industry

Selkirk features an advanced engineering design and premium quality material which allow us to offer a Lifetime Warranty on all component parts. See written warranty for details.

Stainless Steel Chimney Lengths

The chimney must extend at least three feet above the highest point where it passes through the roof surface and at least two feet higher than any part of the building within a horizontal distance of ten feet.

HEIGHT REQUIREMENTS

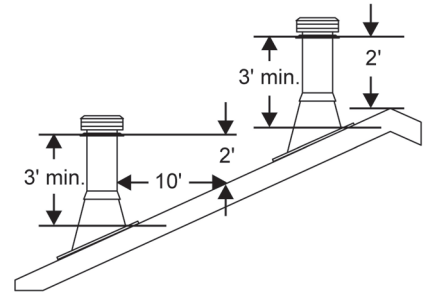

- Slim, advanced design allows for installation between 16" centers
- A 2" clearance to combustible materials must be maintained at all times, except in areas protected by factory supplied support certified for reduced clearance
- Secure twist-lock design couples chimney sections together with just a 1/8th turn
- Sectional overlap of 1-1/8"
- Chimneys are sized according to the inner diameter and are available in 5", 6", 7" and 8"

CHIMNEY SECTIONS

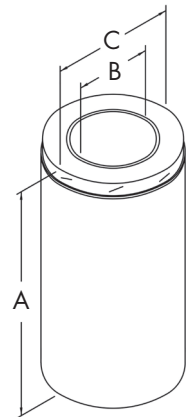

Size	A	B	C	Product Code	Pack
5" x 36"	36"	5"	7"	SPR5L36	1
5" x 24"	24"	5"	7"	SPR5L24	1
5" x 18"	18"	5"	7"	SPR5L18	1
5" x 12"	12"	5"	7"	SPR5L12	1
5" x 6"	6"	5"	7"	SPR5L6	1
6" SECTION					
6" x 48"	48"	6"	8"	SPR6L48	1
6" x 36"	36"	6"	8"	SPR6L36	1
6" x 24"	24"	6"	8"	SPR6L24	1
6" x 18"	18"	6"	8"	SPR6L18	1
6" x 12"	12"	6"	8"	SPR6L12	1
6" x 6"	6"	6"	8"	SPR6L6	1
7" SECTION					
7" x 48"	48"	7"	9"	SPR7L48	1
7" x 36"	36"	7"	9"	SPR7L36	1
7" x 24"	24"	7"	9"	SPR7L24	1
7" x 18"	18"	7"	9"	SPR7L18	1
7" x 12"	12"	7"	9"	SPR7L12	1
7" x 6"	6"	7"	9"	SPR7L6	1
8" SECTION					
8" x 48"	48"	8"	10"	SPR8L48	1
8" x 36"	36"	8"	10"	SPR8L36	1
8" x 24"	24"	8"	10"	SPR8L24	1
8" x 18"	18"	8"	10"	SPR8L18	1
8" x 12"	12"	8"	10"	SPR8L12	1
8" x 6"	6"	8"	10"	SPR8L6	1

Adjustable Chimney Length

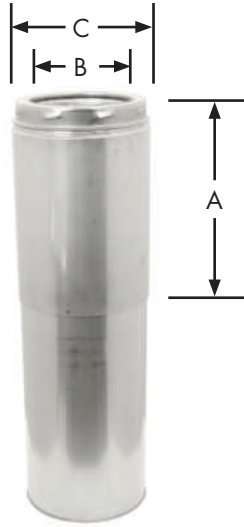

- SuperPro Adjustable Length
- Used to adjust the system to an exact overall height
- Used between elbows for a required offset distance
- All stainless construction and includes hardware
- Length adjusts from 2" to 9-1/2"

Size	A	B	C	Product Code	Pack
5" x 12"	12"	5"	7.31"	SPR5AL12	1
6" x 12"	12"	6"	8.31"	SPR6AL12	1
7" x 12"	12"	7"	9.31"	SPR7AL12	1
8" x 12"	12"	8"	10.31"	SPR8AL12	1

LOCKING BANDS

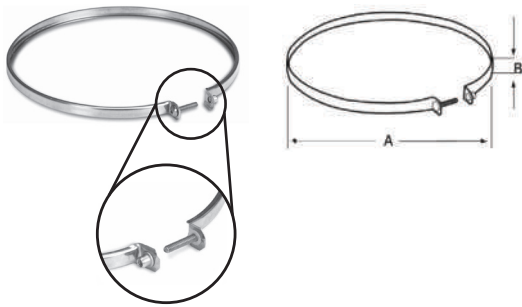

- Two flanges engage the curls in each end of the adjoining sections holding them securely together
- Supplied with Captured Nut & Bolt
- Locking Bands must be used:
 - on all sections that make up an offset
 - on tee branch to attach a chimney length
 - on any length suspended below the Cathedral or Roof Support
- While Locking Bands are not required on other chimney lengths, their use is recommended for added safety and stability. It also provides a more attractive appearance

Size	A	B	Product Code	Pack
5"	7"	7/16"	SPR5SLB	5
6"	8"	7/16"	SPR6SLB	5
7"	9"	7/16"	SPR7SLB	5
8"	10"	7/16"	SPR8SLB	5

Stainless Steel Elbows

15° OFFSET CHART

Offset				Height				Lengths Required				
5"	6"	7"	8"	5"	6"	7"	8"	6"	12"	18"	24"	36"
1-1/2	1-1/8	1-1/8	1-1/4	9	10	10-1/4	10-3/8	-	-	-	-	-
2-1/8	2-3/8	2-3/8	2-1/2	13-1/2	14-1/4	15	15-5/8	1	-	-	-	-
4	4	4	4	19-1/8	20-1/2	20-3/4	21	-	1	-	-	-
5-1/2	5-1/2	5-1/2	5-1/2	25	26-1/4	26-1/2	26-3/4	-	-	1	-	-
7-1/2	7	7	7	30-1/2	32	32-1/4	32-1/2	-	-	-	1	-
10-1/8	10-1/8	10-1/4	10-1/4	42	43-5/8	44	44-1/8	-	-	-	-	1
11-1/4	11-3/8	11-1/2	11-1/2	48-1/4	48-3/8	48-5/8	48-7/8	1	-	-	-	1
12-3/4	13	13	13	54	54-1/8	54-3/8	54-5/8	-	1	-	-	1
14-3/8	14-1/2	14-1/2	14-5/8	59-3/4	60	60-1/8	60-3/8	-	-	1	-	1
16	16-1/8	16-1/8	16-1/8	65-1/2	65-3/4	66	66-1/4	-	-	-	1	1
19	19	19	19	76-1/4	76-1/4	76-1/2	76-3/4	-	1	-	1	1

This chart has three columns for elbow angle required to achieve your desired offset. The first column ("Offset") is the horizontal measurement, at the chimney center line, of the offset needed to get around an obstacle. The second column ("Height") is the height of the assembled offset elbow to the top of the return elbow. Column 3 shows the appropriate lengths required.

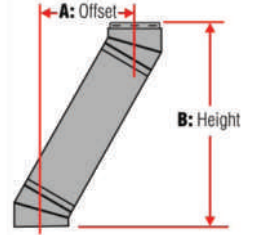

1. Determine the distance of the offset required
2. On the chart, find the predetermined distance required for the elbow kit under the corresponding chimney diameter
3. After finding the offset, follow across the chart to find the specified height and appropriate chimney lengths required under their corresponding diameters

All measurements in inches. Offset tolerances ± one inch.

30° OFFSET CHART

Offset				Height				Lengths Required				
5"	6"	7"	8"	5"	6"	7"	8"	6"	12"	18"	24"	36"
3	2-3/4	3-1/8	3-1/2	10	11-5/8	13	14-1/2	-	-	-	-	-
5-1/4	5-1/4	5-5/8	6	14	15-7/8	17-1/4	18-3/8	1	-	-	-	-
9	8-1/4	8-5/8	9	19-1/4	21	22-3/8	24	-	1	-	-	-
11-1/4	11-1/4	11-5/8	12	24-1/2	26-1/4	27-5/8	29-1/8	-	-	1	-	-
14-1/4	14-1/4	14-5/8	15	29-3/4	31-3/8	32-7/8	32-3/8	-	-	-	1	-
20	20-1/4	20-5/8	21	39-3/4	41-7/8	43-1/4	44-3/4	-	-	-	-	1
21-7/8	22-5/8	23	23-1/2	44-1/2	46	47-1/2	49	1	-	-	-	1
23-7/8	25-5/8	26	26-1/2	50-1/8	51-1/4	52-5/8	54-1/8	-	1	-	-	1
27-1/8	28-5/8	29	29-1/2	55-1/8	56-3/8	57-3/8	59-3/8	-	-	1	-	1
30-3/8	31-5/8	32	32	60-5/8	61-5/8	63	64-1/2	-	-	-	1	1
37	37-1/8	37-1/2	38	69-3/8	71	72-1/2	74	-	1	-	1	1

ELBOW KITS INCLUDE:

- 2 ELBOWS
- 4 LOCKING BANDS
- 1 ELBOW SUPPORT
- HARDWARE PACK



INSULATED 15° AND 30° ELBOW KITS

- The Insulated Elbow is used when an offset is required
- Locking Bands must be used on all elbows
- A maximum of 6 feet is allowable between elbows
- Elbow is fully insulated and can be used at the same 2" clearance as chimney lengths
- Elbow support must be used with all offset installations
- Elbows do not have locking ridges and can be rotated to attain optimum positioning, and allow chimney to return to correct vertical alignment, prior to installing Locking Bands

Stainless Steel Elbows *continued*

15° ELBOW

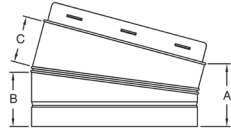

Size	A	B	C	Product Code	Pack
15° - 5"	3-3/8"	2-7/16"	1-15/16"	SPR5EL15K	1
15° - 6"	3-3/8"	2-1/2"	2"	SPR6EL15K	1
15° - 7"	3-3/8"	2-9/16"	2-1/16"	SPR7EL15K	1
15° - 8"	3-3/8"	2-5/8"	2-1/8"	SPR8EL15K	1

30° ELBOW

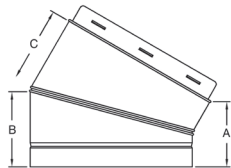

Size	A	B	C	Product Code	Pack
30° - 5"	2-3/4"	2-9/16"	2-9/16"	SPR5EL30K	1
30° - 6"	3-1/4"	3-1/16"	2-9/16"	SPR6EL30K	1
30° - 7"	3-3/4"	3-7/16"	2-15/16"	SPR7EL30K	1
30° - 8"	4-1/4"	3-7/8"	3-3/8"	SPR8EL30K	1

Tee Components

- The insulated chimney tee is used for through-the-wall installation using a wall support
- A chimney length is attached to the tee branch using a Locking Band to pass safely through a wall
- Supplied with uninsulated Tee Plug

Size	A	B	C	D	E	Product Code	Pack
5"	7"	5"	10-1/2"	5"	5"	SPR5ITP	1
6"	8"	6"	11-1/2"	5-5/8"	5-3/4"	SPR6ITP	1
7"	9"	7"	12-1/4"	6-1/4"	6-3/16"	SPR7ITP	1
8"	10"	8"	13-3/8"	6-5/8"	6-1/2"	SPR8ITP	1

INSULATED TEE WITH PLUG

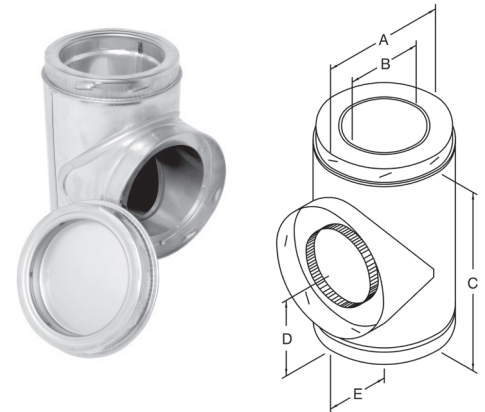

- Used under the AWS Wall Support
- Removable to provide easy access for chimney inspection and maintenance
- Insulated to help maintain flue gas temperature

Size	A	B	C	Product Code	Pack
5"	7"	5"	2-7/8"	J51TPI	1
6"	8"	6"	2-7/8"	J61TPI	1
7"	9"	7"	2-7/8"	J71TPI	1
8"	10"	8"	2-7/8"	J81TPI	1

INSULATED TEE PLUG

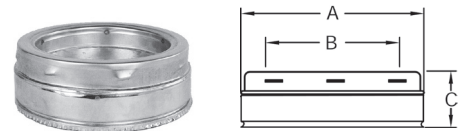

- Replacement Non-Twist Lock Insulated Tee Cap used with the WS Wall Support
- Removable to provide easy access for chimney inspection and maintenance
- Insulated to help maintain flue gas temperature

Size	A	B	C	Product Code	Pack
5"	6-1/8"	4-31/32"	1-9/32"	SPR5NTITC	1
6"	7-1/8"	5-31/32"	1-9/32"	SPR6NTITC	1
7"	8-1/8"	6-31/32"	1-9/32"	SPR7NTITC	1
8"	9-1/8"	7-31/32"	1-9/32"	SPR8NTITC	1

NON-TWIST LOCK INSULATED TEE CAP

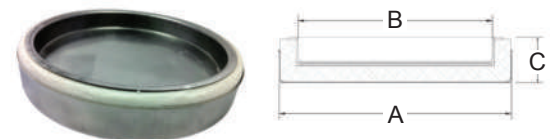

Supports

ADJUSTABLE WALL SUPPORT

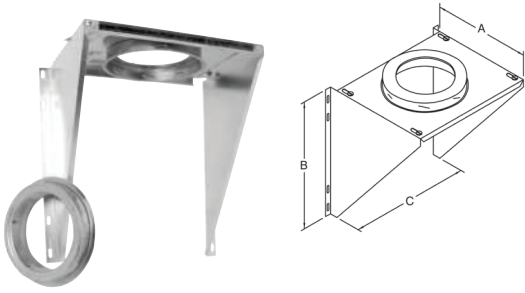

- Used to support the chimney on a through-the-wall installation
- Will support up to 38 feet of chimney
- Includes wall support top plate with female coupler attached, male adapter ring, side brackets and hardware

Size	A	B	C	Product Code	Pack
5"	10"	17-1/8"	16"	JSC5AWS	1
6"	11"	17-1/8"	16"	JSC6AWS	1
7"	12"	17-1/8"	16"	JSC7AWS	1
8"	13"	17-1/8"	16"	JSC8AWS	1

ADJUSTABLE INTERMEDIATE WALL SUPPORT

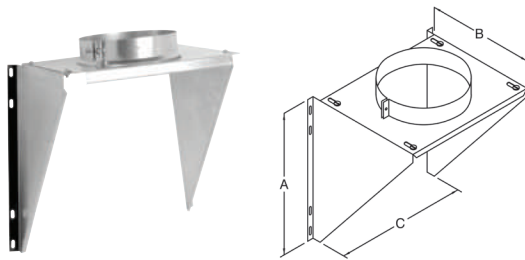

- Used as supplementary support when chimney system height exceeds maximum height allowed by Wall Support
- Supports an additional 38 feet of chimney
- Includes Top Plate, Support Band, Side Brackets and Hardware

Size	A	B	C	Product Code	Pack
6"	17-1/8"	11"	16"	JSC6AIWS	1
7"	17-1/8"	12"	16"	JSC7AIWS	1
8"	17-1/8"	13"	16"	JSC8AIWS	1

ADJUSTABLE WALL SUPPORT WITH INSULATED TEE CAP

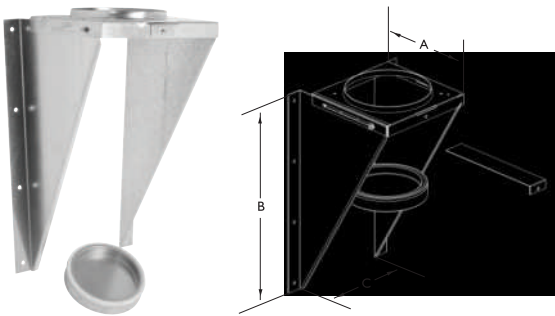

- Used to support chimney on a through-the-wall installation
- Will support between 30 feet and 74 feet of chimney height based on size & orientation from wall
- Adjustment of 2" to 6" from a vertical wall
- Includes wall support top plate, side brackets, hardware, non-twist lock insulated tee cap, and L-bracket to contain tee cap

Size	A	B	C	Product Code	Pack
5"	10-5/8"	18-7/8"	12"	JSC5WS	1
6"	10-5/8"	18-7/8"	12"	JSC6WS	1
7"	11-5/8"	20-1/2"	13"	JSC7WS	1
8"	12-5/8"	21-7/8"	14"	JSC8WS	1

UNIVERSAL EXTENDED WALL SUPPORT

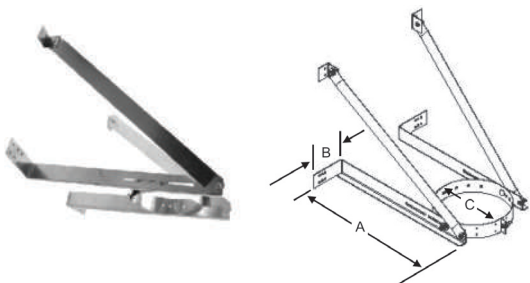

- Designed to support a vertical wall installation above the insulated tee
- Will support up to 28 feet of chimney
- Adjusts up to 12" from a vertical wall & will allow to pass by a 12" overhang

Size	A	B	C	Product Code	Pack
6" to 8"	22"	4"	8" to 10"	0800900	1

Supports continued

- Supports up to 50 feet of chimney
- Matte black support gives a finished appearance

Size	A	B	C	Product Code	Pack
6"	17-7/8"	12-3/8"	8-1/4"	JSC6DCSS	1
7"	17-7/8"	13-3/8"	9-1/4"	JSC7DCSS	1
8"	19-5/8"	14-3/8"	10-1/4"	JSC8DCSS	1

- For use in ceiling support installations
- Supports up to 50 feet of chimney
- Matte black finish gives a premium finished appearance

Size	A	B	C	Product Code	Pack
5"	17-7/8"	11-3/8"	7-1/4"	SPR5CSB	1
6"	17-7/8"	12-3/8"	8-1/4"	SPR6CSB	1
7"	17-7/8"	13-3/8"	9-1/4"	SPR7CSB	1
8"	19-5/8"	14-3/8"	10-1/4"	SPR8CSB	1

- Used in pitched ceiling support installations
- Supports up to 38 feet of chimney
- Matte black finish
- Includes Support Box, Support Band and Ceiling Trim pieces

Size	A	B	C	Product Code	Pack
5"	7-3/16"	11"	17"	SPR5CCSB	1
6"	8-3/16"	12"	17"	SPR6CCSB	1
7"	9-3/16"	13"	17"	SPR7CCSB	1
8"	10-3/16"	14"	17"	SPR8CCSB	1

- The Roof Support may be used on a floor, ceiling or roof and adjusts to any roof pitch
- It may be used above an offset to support the offset or as a supplementary support when the chimney height exceeds that of the primary support
- The Roof Support will support a total height of 50 feet of chimney

Size	A	B	Product Code	Pack
5"	7"	5"	JSC5RS	1
6"	8"	5"	JSC6RS	1
7"	9"	5"	JSC7RS	1
8"	10"	5"	JSC8RS	1

DECORATOR CEILING SUPPORT-SPUN

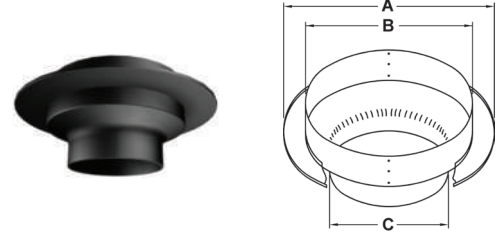

DECORATOR CEILING SUPPORT

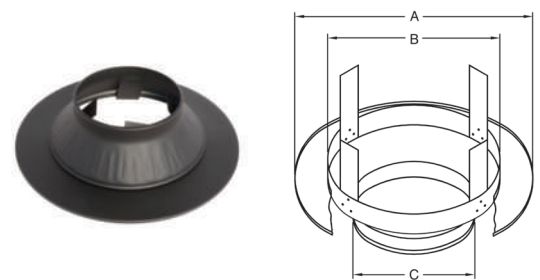

CATHEDRAL CEILING SUPPORT BOX

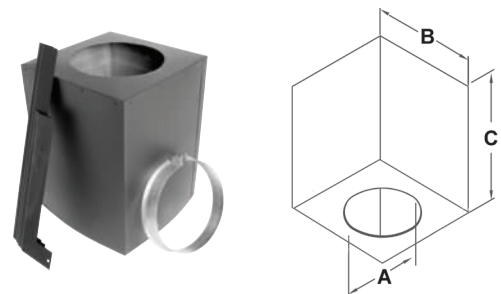

Add JUSI (pg. 17) to the Cathedral Ceiling Support for increased performance and safety.

ROOF SUPPORT

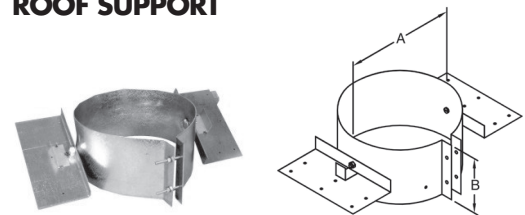

Shields

ATTIC INSULATION SHIELD

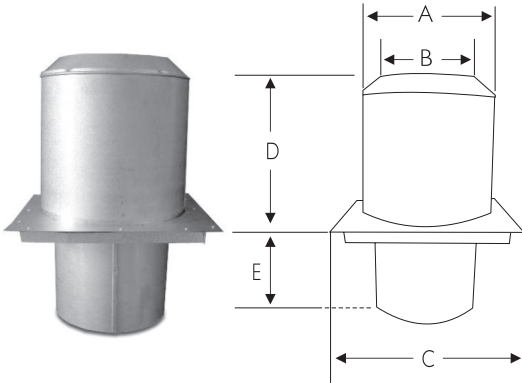

Add JUSI (pg. 17) to the Attic Insulation Shield for increased performance and safety.

- The AIS must be installed where the chimney enters the attic space in any installation
- When fully extended the AIS provides joist shielding
- Designed to keep insulation away from the chimney, and to maintain the mandatory 2" clearance to combustibles

Size	A	B	C	D	E	Product Code	Pack
5"	11"	7"	13"	11-13/16"	8-1/2"	JSC5AIS	1
6"	12"	8"	14"	11-13/16"	8-1/2"	JSC6AIS	1
7"	13"	9"	15"	11-13/16"	8-1/2"	JSC7AIS	1
8"	14"	10"	16"	11-13/16"	8-1/2"	JSC8AIS	1

FIRESTOP RADIATION SHIELD

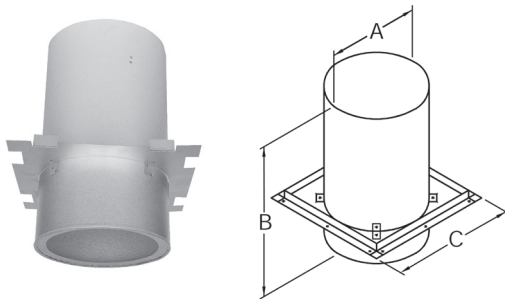

- Also known as a Firestop Joist Shield
- Required where the chimney passes from one lower living space to another living space
- Maintains the mandatory 2" clearance to combustibles

Size	A	B	C	Product Code	Pack
5"	9"	19"	13"	JSC5FRS	1
6"	10"	19"	14"	JSC6FRS	1
7"	11"	19"	15"	JSC7FRS	1
8"	12"	19"	16"	JSC8FRS	1

RAFTER RADIATION SHIELD

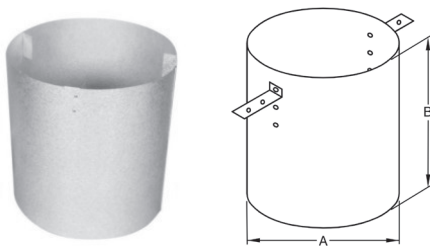

The RRS must be installed where the chimney is enclosed immediately below the roof line

Size	A	B	Product Code	Pack
5"	9"	12"	JSC5RRS	1
6"	10"	12"	JSC6RRS	1
7"	11"	12"	JSC7RRS	1
8"	12"	12"	JSC8RRS	1

WALL THIMBLE

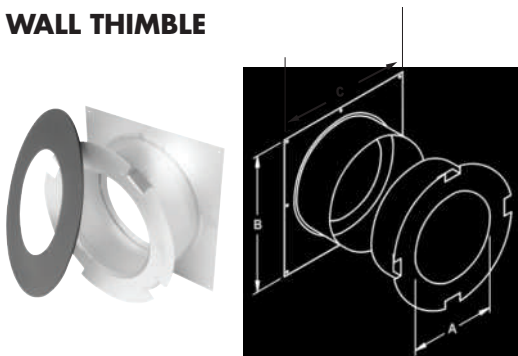

Add JUSI (pg. 17) to the Wall Thimble for increased performance and safety.

- Used in a wall support installation
- Radiation shield is included with spacers which maintain the mandatory 2" clearance to combustibles
- Attractive matte black finishing trim is included
- Extends to fit 7" wall thickness

Size	A	B	C	Product Code	Pack
5"	7-1/8"	16"	16-1/8"	SPR5WTB	1
6"	8-1/8"	16"	16-1/8"	SPR6WTB	1
7"	9-1/8"	16"	16-1/8"	SPR7WTB	1
8"	10-1/8"	16"	16-1/8"	SPR8WTB	1

Flashings and Storm Collars

To determine what Roof Flashing you'll require, you must work out the pitch of your roof. To determine the pitch, you'll need two rulers and a level. Measure the number of inches from the end of the level down to the roof.

ROOF FLASHING SELECTION CHART

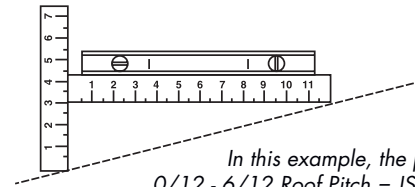

In this example, the pitch is 3/12.
 0/12 - 6/12 Roof Pitch = JSC 6 or 7 AAF
 6/12 - 12/12 Roof Pitch = JSC 6 or 7 AF2

- Used where the chimney passes through a roof with a pitch of Flat to 6/12
- Comes complete with Storm Collar
- All seams are sealed with Silicone Sealant
- Galvalume construction

Size	A	Product Code	Pack
5"	24" x 24"	JSC5AAF-3	3
6"	24" x 24"	JSC6AAF-3	3
7"	24" x 24"	JSC7AAF-3	3
8"	27-1/2" x 27-1/2"	JSC8AAF-3	3

ADJUSTABLE FLASHING ASSEMBLY- FLAT TO 6/12

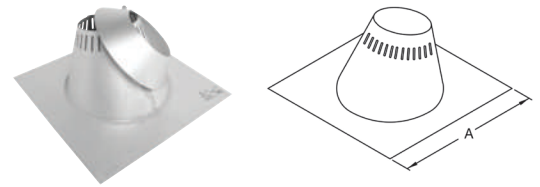

- Used where the chimney passes through a roof with a pitch of 6/12 to 12/12
- Comes complete with Storm Collar
- All seams are sealed with Silicone Sealant
- Galvalume construction

Size	A	Product Code	Pack
5"	30" x 21-1/2"	JSC5AF2-3	3
6"	30" x 21-1/2"	JSC6AF2-3	3
7"	30" x 21-1/2"	JSC7AF2-3	3
8"	30" x 21-1/2"	JSC8AF2-3	3

ADJUSTABLE FLASHING ASSEMBLY- 6/12 TO 12/12

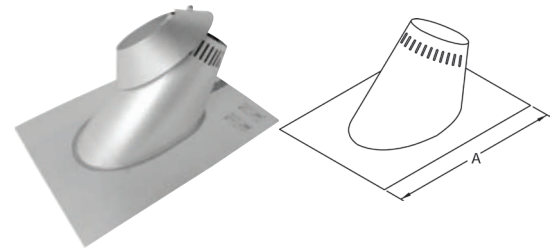

- Used on flat roof surfaces
- All seams are sealed with Silicone Sealant
- Comes complete with Storm Collar

Size	A	B	Product Code	Pack
5"	24"	12"	JSC5ATC	3
6"	24"	12"	JSC6ATC	3
7"	24"	12"	JSC7ATC	3
8"	24"	12"	JSC8ATC	3

TALL CONE FLASHING

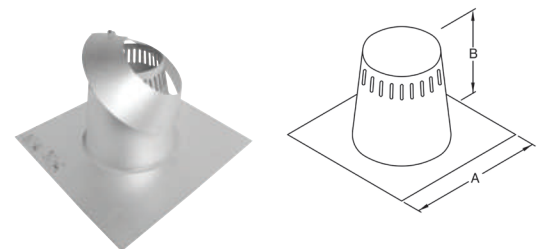

PEAK FLASHING - 3/12 TO 6/12

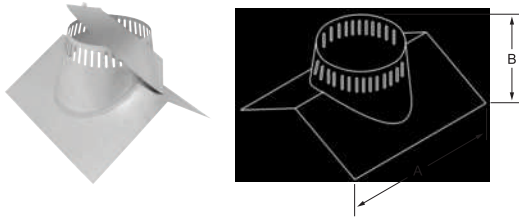

- Available in 7" only
- Required where the chimney passes through a peaked roof with a pitch of 3/12 to 6/12
- Comes complete with Storm Collar

Size	A	B	Product Code	Pack
7"	22"	10"	JSC7P1	1

PEAK FLASHING - 7/12 TO 9/12

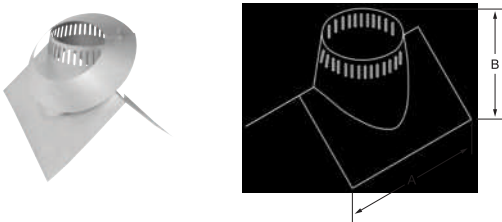

- Available in 7" only
- Required where the chimney passes through a peaked roof with a pitch of 7/12 to 9/12
- Comes complete with Storm Collar

Size	A	B	Product Code	Pack
7"	20"	14"	JSC7P2	1

RUBBER BOOT FLASHING KIT



- This kit fits 5", 6", 7" and 8" Chimneys
- Used where the chimney passes through a corrugated roof
- Rubber Boot Flashing fits roof pitches up to 12/12 (10/12 for 8")
- Kit includes rubber boot, spacer kit, special storm collar and mounting hardware

Size	Product Code	Pack
ALL	JURBFK1	1

ALUMINUM STORM COLLAR

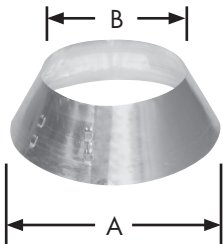

Used in conjunction with Roof Flashing to keep precipitation out.

Size	A	B	Product Code	Pack
5"	7"	5-1/2"	JSC56ASC-1	1
6"	8"	5-1/2"	JSC56ASC-1	1
7"	9"	5-1/2"	JSC78ASC-1	1
8"	10"	5-1/2"	JSC78ASC-1	1

SILICONE SEALANT FOR STORM COLLAR



Used to seal Storm Collar to chimney length above cone of flashing.

Size	Product Code	Pack
3 ounce tube	JRTV	1

Premium Rain Caps

- Advanced design, premium quality stainless steel
- Provides protection against the elements
- Twist-lock connection for secure installation

Size	A	B	C	Product Code	Pack
5"	7"	7-1/8"	11-1/4"	SPR5DRC	1
6"	8"	7-1/4"	11-1/4"	SPR6DRC	1
7"	9"	7-1/2"	13-1/4"	SPR7DRC	1
8"	10"	7-5/8"	14-1/4"	SPR8DRC	1

Stainless steel mesh wire fits inside Rain Cap.

Size	Dimensions	Product Code	Pack
5"	4-1/2" x 26"	JSC5SPAR	10
6"	4-1/2" x 26"	JSC6SPAR	10
7"	4-1/2" x 29"	JSC7SPAR	10
8"	4-1/2" x 32"	JSC8SPAR	10

- Designed to address chimneys with downdraft issues.
- Diverts wind and rain to ensure flue gases are directed outward efficiently & effectively.
- Constructed of 300 Series Stainless Steel for strength & durability.
- Available in 5", 6", 7", 8" & 10" Diameters
- Listed & approved to UL 103HT

Size	A	B	C	Product No.	Part No.	Pack
5"	17-1/4"	6"	4-3/4"	195802	5DK	1
6"	19-1/4"	7"	5-3/4"	196802	6DK	1
7"	19-1/4"	8"	6-3/4"	197802	7DK	1
8"	19-1/4"	9"	7-3/4"	198802	8DK	1
10"	19-1/4"	11"	9-3/4"	1910802	10DK	1

DELUXE RAIN CAP

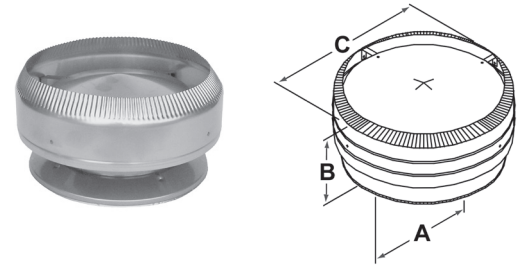

SPARK ARRESTOR

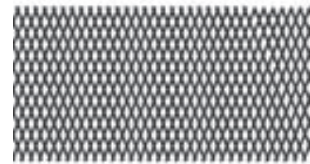

DIKAPT CHIMNEY CAP

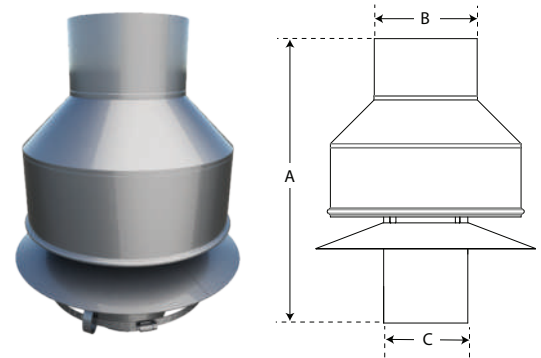

Parts and Accessories

UNIVERSAL WALL BAND

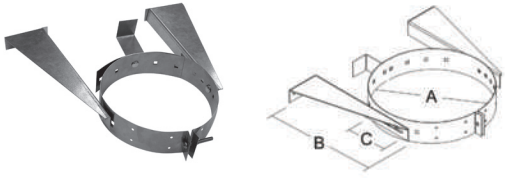

- Provides lateral support for the chimney when installed adjacent to a wall
- Provides more than 4" of horizontal adjustability to clear some overhangs and obstructions
- Required at 8 foot or closer intervals to stabilize the chimney, whenever it is supported along a vertical wall

Size	A	B	C	Product Code	Pack
6" to 8"	8" to 10"	17"	4"	JSC-UWB	1

WALL BAND

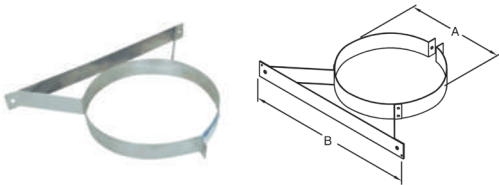

- Stainless steel construction
- Provides lateral support for the chimney when installed adjacent to a wall
- Maintains the mandatory 2" clearance to combustibles
- Installed on first length above the Tee, then every 8 feet thereafter

Size	A	B	Product Code	Pack
5"	7"	17"	JSC5WB	1
6"	8"	17"	JSC6WB	1
7"	9"	17"	JSC7WB	1
8"	10"	17"	JSC8WB	1

BLACK STOVE PIPE ADAPTER

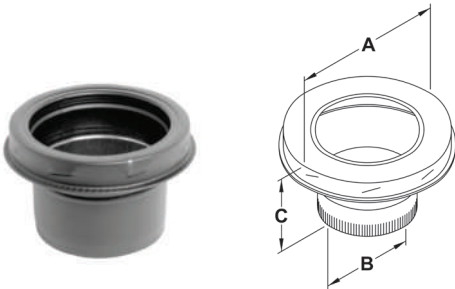

- For a quick and easy transition from black stove pipe to factory-built chimney
- Twist-lock for easy connection

Size	A	B	C	Product Code	Pack
5"	7"	5"	5"	JSC5ASE	1
6"	8"	6"	5"	JSC6ASE	1
7"	9"	7"	5"	JSC7ASE	1
8"	10"	8"	5"	JSC8ASE	1

Parts and Accessories continued

- Used where the chimney passes through a soffit to provide a finished appearance
- Maintains the mandatory 2" clearance to combustibles

Size	A	B	Product Code	Pack
5"	7-1/8"	13"	JSC5FP	1
6"	8-1/8"	14"	JSC6FP	1
7"	9-1/8"	15"	JSC7FP	1
8"	10-1/8"	16"	JSC8FP	1

FINISHING PLATE

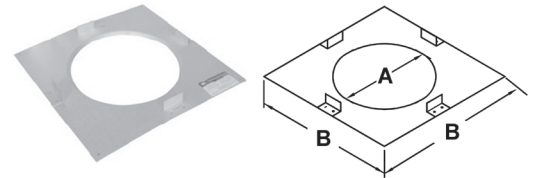

- Designed to provide extra stability for chimney system above roof line
- Required when the chimney extends 5 feet or more above the roof. Use one kit every 5 feet
- Telescoping legs can adjust from 5' to 9'
- Support band adjusts to fit 6", 7", and 8" chimney

Size	Dimensions	Product Code	Pack
6" to 8"	Band adjusts 8" to 10"	0843900	1

HEAVY DUTY UNIVERSAL ROOF BRACE KIT



- Designed to deflect snow and ice while preventing unnecessary strain or damage to chimney
- Mounts directly above chimney pipe with easy panel assembly
- Made from heavy gauge galvanized steel

Size	Product Code	Pack
5" to 8"	2001922	1

UNIVERSAL SNOW SPLITTER



- Insulation for use with:
 - Attic Insulation Shield (JSC* AIS)
 - Wall Thimble (SPR*WTB)
 - Cathedral Ceiling Support (SPR*CCSB)
- Reduces cold air infiltration into the dwelling
- Provides additional protection against heat from the chimney

Size	Dimensions	Product Code	Pack
Universal	2" x 12" x 48"	JUSI	1

JUSI-UNIVERSAL SHIELDING INSULATION

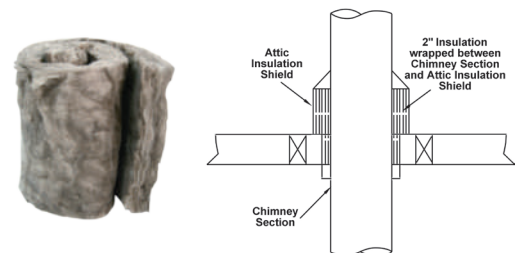

Fireplace Parts

ADAPTOR PLATE

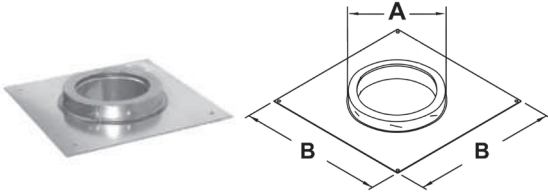

Used on masonry fireplaces and with specific factory-built fireplaces listed to UL 127 or CAN/ULC-S610.

Size	A	B	Product Code	Pack
5"	7"	11-5/8"	JSC5AP	1
6"	8"	11-5/8"	JSC6AP	1
7"	9"	11-5/8"	JSC7AP	1
8"	10"	11-5/8"	JSC8AP	1

INSULATED CHASE PLUG

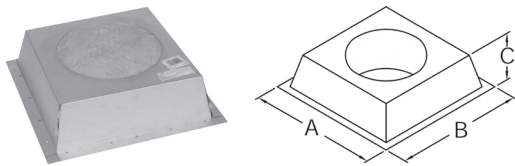

- Recommended to reduce air infiltration through the chase in cold climates
- Maintains the thermal envelope of your home
- For use with wood-burning fireplaces certified with Model SPR chimney
- A trim plate is provided when a 6" chimney is used
- Used with specific factory-built fireplaces listed to UL 127 or CAN/ULC-S610

Size	A	B	C	Product Code	Pack
6" & 7"	15"	15"	4-1/4"	JSC7CP	1

30°/45° INSULATED WALL PLUG

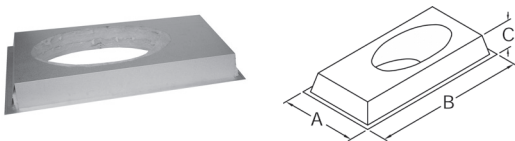

- For use where the chimney passes through a wall at a 30° & 45° angle
- Insulated to maintain the thermal envelope of your home
- For use with wood-burning fireplaces certified with Model SPR chimney
- A trim plate is provided - to be used when a 6" diameter chimney is used with 30° or 45° angle or when a 7" diameter chimney is used with 45° angle
- Used with specific factory-built fireplaces listed to UL 127 or CAN/ULC-S610

Size	A	B	C	Product Code	Pack
6" & 7"	15"	15"	4-1/4"	JSC7WC	1

NOTE: 45° angle can only be used in Canada.

Support Kits

SUPERPRO HAS PUT TOGETHER 3 CHIMNEY KITS TO GET YOUR PROJECT DONE...

SuperPro has taken the guess work out of chimney installation by putting the most common parts for each installation all in one box. These 3 kits depict the most common installations. Simply decide which of these scenarios fits your need, then pick up your chimney lengths, roof flashing and elbows (if required).

When your chimney goes up through a flat ceiling, then thru the roof, you may choose the MODEL SPR DECORATOR CEILING SUPPORT INSTALLATION KIT - SPR*DCKS

- Deluxe Rain Cap
- Attic Insulation Shield
- Decorator Ceiling Support
- Stove Pipe Adaptor

NOTE: For a two story application, an additional Firestop Radiation Shield must be installed.

...Now you just need your roof flashing and chimney lengths.

CEILING SUPPORT KIT

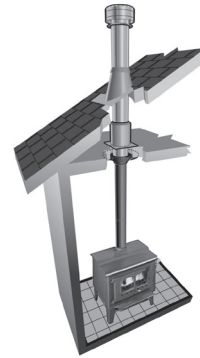

Size	Product Code
5"	SPR5DCSK
6"	SPR6DCSK
7"	SPR7DCSK
8"	SPR8DCSK

When your chimney goes out a cathedral or open beam ceiling, you may choose the MODEL SPR CATHEDRAL CEILING SUPPORT INSTALLATION KIT - SPR*CCSK

- Deluxe Rain Cap
- Cathedral Ceiling Support
- Draw Band
- Trim Kit
- Stove Pipe Adaptor

...Now you just need your roof flashing and chimney lengths

CATHEDRAL CEILING SUPPORT KIT



Size	Product Code
6"	SPR6CCSK
7"	SPR7CCSK
8"	SPR8CCSK

When your chimney goes out a wall and then runs straight up, you'll need the MODEL SPR WALL SUPPORT INSTALLATION KIT - SPR*WSK

- Deluxe Rain Cap
- Wall Bands (2)
- Stove Pipe Adaptor
- Wall Thimble
- Stainless Steel Tee
- Adjustable Wall Support (WS) with Non-Twist Lock Insulated Tee Cap

...Now you just need:

- Vertical Chimney lengths
- Through the wall length (must extend at least 3" into the room)

WALL SUPPORT KIT

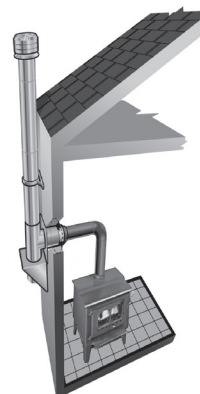

Size	Product Code
5"	SPR5WSK
6"	SPR6WSK
7"	SPR7WSK
8"	SPR8WSK

Notes

Lined area for taking notes, consisting of 25 horizontal red lines.



BUILD FOR THE FUTURE

Customer Service and Support:

Airmate (USA).....	800.992.8368
Airmate (CAN)	888.735.5475
Ameriflow	800.252.8467
Amerivent (Retail).....	800.252.8467
Amerivent (Hearth & Wholesale)	800.423.4270
Amerivent (Support).....	800.748.0392
AMPCO (USA)	800.669.3269
AMPCO (CAN).....	888.735.5475
Duravent	800.835.4429
Hart & Cooley.....	800.433.6341
Hart & Cooley (Support)	800.748.0392
Heatfab (USA).....	800.772.0739
Heatfab (CAN)	800.848.2149
Lima.....	800.423.4270
Milcor	800.774.5240
Portals Plus.....	800.774.5240
RPS.....	800.624.8642
Security Chimney (USA).....	800.361.4909
Security Chimney (CAN)	800.667.3387
Selkirk (USA) Residential	800.992.8368
Selkirk (USA) Commercial.....	800.848.2149
Selkirk (USA) Support.....	800.748.0392
Selkirk (CAN)	888.735.5475

Manufacturing & Distribution Centers:

CANADA	
Nobel, ON	Manufacturing
Laval, QC	Manufacturing
Prescott, ON	Distribution
USA	
Grand Rapids, MI	Center of Excellence
Dallas, TX	Distribution
Englewood, OH	Distribution
Huntsville, AL	Manufacturing & Distribution
Mira Loma, CA	Distribution
Nampa, ID	Manufacturing & Distribution
Turner Falls, MA	Manufacturing & Distribution
Vacaville, CA	Manufacturing
MEXICO	
Ojinaga, MX	Manufacturing
Mexicali, MX	Manufacturing

Corporate Headquarters:

Duravent Group
 28 W. Adams, Suite 1810
 Detroit, MI 48226
 Tel: 800.835.4429
 Email: info@duraventgroup.com
www.duraventgroup.com



BUILD FOR THE FUTURE

www.duraventgroup.com



For warranty information:
Scan this QR code or visit
www.duraventgroup.com/warranties