

DuraPlus[®]

All-fuel, triple-wall
chimney system.

UL 103 HT.



Specifications

Applications

DuraPlus Chimney is a triple-wall, all-fuel chimney for use with wood stoves, fireplaces, furnaces, boilers, stoves, ranges, water heaters, or other appliances fueled by wood, oil, coal, or gas.

Materials and Construction

.016" 430 stainless steel outer wall or .018" galvanized steel outer wall.
.018" aluminized steel intermediate liner. .016" 430 stainless steel inner liner.
Insulated layers plus ventilated air space.
Locks tightly with a precision twist-lock connection.

Clearances

2" clearance to combustibles.

Diameters

6"-8"

Listings

UL Listed to UL 103HT (MH7399).



UL 103 HT System

DuraPlus

DuraPlus is designed to stay cool on the outside, to provide a hot draft on the inside, to boost stove efficiency, and to provide for a fire-safe design that protects both the chimney and the building. This triple-wall chimney features two insulating layers (refractory blanket, plus air space). The refractory insulation is held securely in position, eliminating hot spots common with loose-fill type insulations. In the event of a creosote fire, the compressible blanket insulation permits the chimney liner to expand outwardly in a radial direction.

Designed for normal, continuous operation at 1000° F flue gas temperatures, DuraPlus is subjected to rigorous and stringent HT requirements of the UL standard, including one hour at 1400° F, plus three ten minute chimney fire tests at 2100° F.



Typical Installations

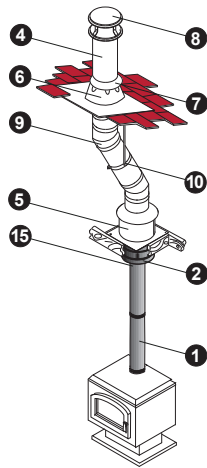

Attic Offset

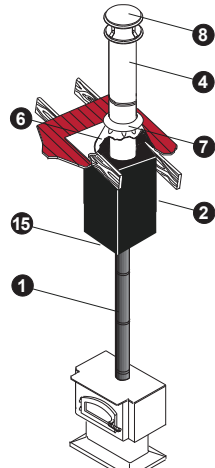

Cathedral Ceiling Roof Support

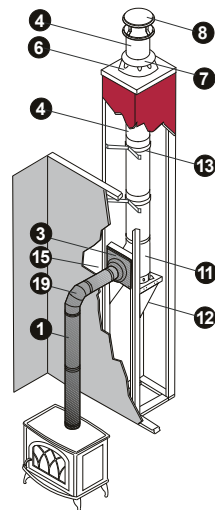

Through-the-Wall

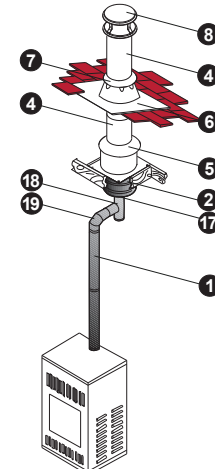

Oil Furnace

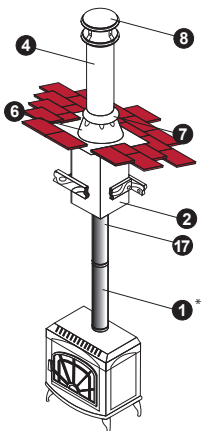

Manufactured Home

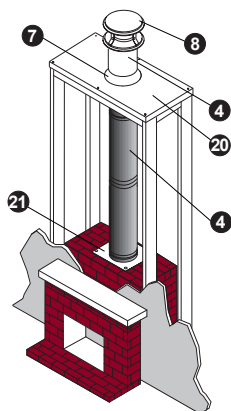

Fireplace
(New or retrofit)

Installation Key			
1	DVL or DuraBlack Stovepipe	12	Tee Support Bracket
2	Ceiling Support Box	13	Wall Strap
3	Wall Thimble	14	Firestop Radiation Shield
4	DuraPlus Chimney	15	Snap-Lock Adapter, DVL/DuraBlack Chimney Adapter, DuraBlack Slip Connector
5	Attic Insulation Shield	16	Extended Roof Bracket
6	Roof Flashing	17	DVL or DuraBlack Chimney Adapter
7	Storm Collar	18	DVL or DuraBlack Tee
8	Chimney Cap	19	DVL or DuraBlack Elbow
9	Elbow	20	Chase Top Flashing
10	Elbow Strap	21	Anchor Plate
11	Tee with Cap		

- Refer to our Typical Venting Installation drawings to select the appropriate component parts for your installation.
- A DVL/DuraBlack Chimney Adapter or DuraBlack Slip Connector must be used when connecting DVL or DuraBlack stovepipe to a Ceiling Support or Wall Thimble. A Snap-Lock Adapter must be used when attaching snap-lock stovepipe to DuraPlus.
- A Wall Thimble must be installed with an appropriate section of chimney pipe for all horizontal through-the-wall installations. To accommodate thicker walls, a wall thimble extension can be field fabricated.
- An Attic Insulation Shield must be used in all installations that pass through an attic, regardless of whether the attic is insulated or not. If the chimney is enclosed in a chase in the attic space, an Attic Insulation Shield is not required.
- A Firestop Radiation Shield must be used when a chimney passes through a floor or ceiling without a Ceiling Support Box.

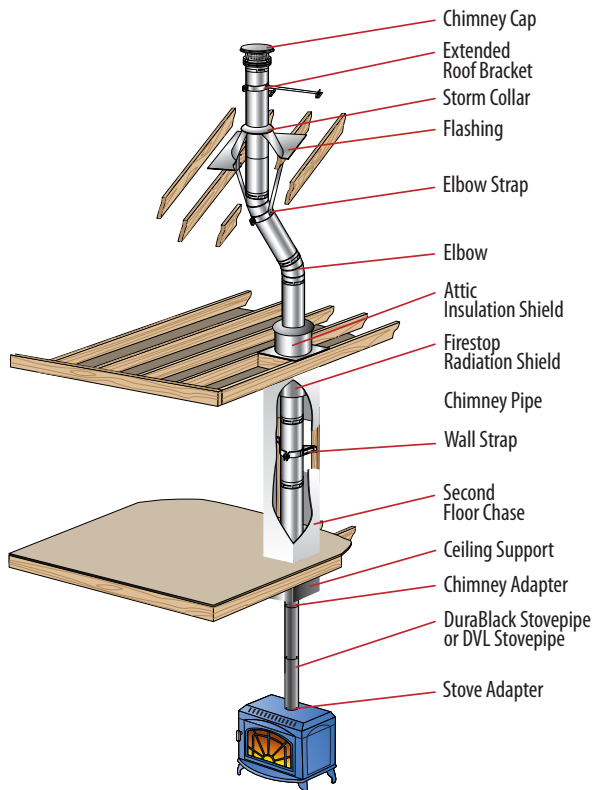

Planning Your Installation

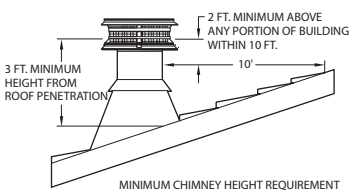

Figure 1

The following recommendations are a general guideline to assist in the layout and selection of the chimney components needed for your installation. Always follow DuraVent installation instructions before installing your chimney system (enclosed with the cap or support box). Installation instructions can be viewed online at www.duravent.com, under support > literature.

- The diameter of the chimney should match the outlet size of the appliance. An improperly sized chimney results in poor draft and excessive creosote formation.
- Measure the diameter of the appliance flue outlet. Select the chimney and either DVL or DuraBlack connector stovepipe with the same size diameter as the appliance flue outlet. For fireplace installations, refer to the sizing chart in the back of this section of this catalog.
- Determine if the installation is a through-the-roof installation or a through-the-wall installation. A through-the-wall installation will require additional components (Wall Thimble, Tee w/ Cap, Tee Support, and Wall Straps).
- Install the chimney in the interior of the structure whenever possible. A cold exterior chimney will produce less draft and will generate more creosote.
- If possible, avoid offsets that serve to restrict the natural draft. A straight vertical installation is more efficient and less likely to develop creosote. If an offset is required to avoid rafters or other obstructions, measure the horizontal distance required and the vertical height available. Both 15° and 30° elbows are available. Elbows greater than 30° are not allowed in the United States. A maximum of two offsets (four elbows) in a single installation are permitted. Refer to the offset table in the back of this section of the catalog. At least one Elbow Strap is required for each offset. Elbow Straps ensure adequate support.
- Determine the minimum chimney height above the roof line. Building codes require a minimum of 3' above the roof penetration and at least 2' higher than any portion of a building within 10'. See figure 1. The termination cap is installed above that point. If chimney is more than 4' above the roof penetration an Extended Roof Bracket is required.
- Measure the roof pitch. For example, a 6/12 pitch has a vertical rise of 6" over a horizontal distance of 12". Select the appropriate flashing.
- Determine the total length of chimney and stovepipe required for the installation. To calculate the installed per length of 6"-8" DuraPlus chimney pipe, subtract 1 1/2" per joint. Subtract 1 1/4" per joint of DuraBlack stovepipe. Subtract 1 1/2" per joint of DVL stovepipe. Minimum chimney height, at sea level, of straight vertical chimney is 10' to 15' above the appliance outlet. Higher elevations, or the use of elbows or a tee, will require approximately 30% to 60% more height to provide for an adequate draft.
- Be fire safe. Maintain at least 2" clearance to combustibles. Follow local building codes and have your chimney inspected by a certified professional.

Through the Ceiling Kit



Kit includes: DVL and DuraBlack Chimney Adapter, Snap-Lock Adapter w/ Trim, 11" Square Ceiling Support Box with Trim, Adjustable Flashing 0/12-6/12, Chimney Cap, Storm Collar, and Attic Insulation Shield. Only available in 6" diameter. Pipe not included. Can be used for flat or vaulted ceiling installations.

Use for typical through-the-roof installations.

SIZE	6"
ORDER #	6DP-KBSC
STOCK #	810000512

Through-The-Wall Kit



Kit includes: DVL and DuraBlack Chimney Adapter, Snap-Lock Adapter w/ Trim, 9" DuraPlus Chimney Pipe (galvanized), Wall Thimble, Tee w/ Cap, (2) Wall Strap, Tee Support Bracket, and Chimney Cap. Only available in 6" diameter.

Use for through-the-wall installations.

SIZE	6"
ORDER #	6DP-KTTW
STOCK #	810000514

Manufactured Home Kit



Kit includes: DVL and DuraBlack Adapter, 24" Square Ceiling Support Box with Trim, Adjustable Flashing 0/12-6/12, Chimney Cap, Storm Collar, and (2) 24" DuraPlus Chimney Pipe (galvanized). Only available in 6" diameter. Can be used for cathedral ceiling installations.

Use for manufactured home through-the-roof installations.

SIZE	6"
ORDER #	6DP-KMFG
STOCK #	810000513

Pipe Selection Chart

Installed Chimney Height	Chimney Sections Used				Installed Chimney Height	Chimney Sections Used			
	6"	12"	24"	36"		6"	12"	24"	36"
6"	1				14'-10 1/2"	1			5
1'		1			15'-4 1/2"		1		5
2'			1		16'-4 1/2"			1	5
3'				1	17'-4 1/2"				6
3'-4 1/2"	1			1	17'-9"	1			6
3'-10 1/2"		1		1	18'-3"		1		6
4'-10 1/2"			1	1	19'-3"			1	6
5'-10 1/2"				2	20'-3"				7
6'-3"	1			2	20'-7 1/2"	1			7
6'-9"		1		2	21'-1 1/2"		1		7
7'-9"			1	2	22'-1 1/2"			1	7
8'-9"				3	23'-1 1/2"				8
9'-1 1/2"	1			3	23'-6"	1			8
9'-7 1/2"		1		3	24'		1		8
10'-7 1/2"			1	3	25'			1	8
11'-7 1/2"				4	26'				9
12'	1			4	26'-4 1/2"	1			9
12'-6"		1		4	26'-10 1/2"		1		9
13'-6"			1	4	27'-10 1/2"			1	9
14'-6"				5	28'-10 1/2"				10

Chimney Pipe



Designed for appliances tested and listed for use with wood stoves, fireplaces, furnaces, boilers, stoves, ranges, water heaters, or other appliances fueled by wood, oil, coal, or gas. 6", 9", and 12" chimney pipe has 1" insulation blanket; 24", 36" chimney pipe has 1/2" insulation. To calculate the installed length of DuraPlus chimney pipe, subtract 1 1/2" from each length of chimney pipe.

Additional protective carton filler for shipping is available, items have stock numbers with (CF).

LENGTH	6" DIAMETER		7" DIAMETER		8" DIAMETER	
	ORDER #	STOCK #	ORDER #	STOCK #	ORDER #	STOCK #
A	6"		7"		8"	
B	10"		11"		12"	
6"	6DP-06	810000515	7DP-06	810000565	8DP-06	810000600
9"	6DP-09	810000516	7DP-09	810000566	8DP-09	810000601
12"	6DP-12	810000517	7DP-12	810000567	8DP-12	810000602
12" SS	6DP-12SS	810000518	--	--	--	--
24"	6DP-24	810000519	7DP-24	810000568	8DP-24	810000603
24"	--	--	--	--	8DP-24CF	810000604
24" SS	6DP-24SS	810000520	7DP-24SS	810000569	8DP-24SS	810000605
24" SS	--	--	--	--	8DP-24SSCF	810000606
36"	6DP-36	810000521	7DP-36	810000570	8DP-36	810000607
36"	6DP-36CF	810000522	--	--	8DP-36CF	810000608
36" SS	6DP-36SS	810000523	7DP-36SS	810000571	8DP-36SS	810000609
36" SS	6DP-36SSCF	810000524	--	--	8DP-36SSCF	810000610

Elbow Kit



Kit includes: (2) elbows and one Elbow Strap.

Use for offsets around obstructions such as rafters, ridgepoles, or joists. May have two pairs of elbows, if needed. Offsets greater than 30° are not permitted in accordance to UL 103 standards. Elbows swivel 360° at base (angles are not adjustable). A pair of elbows is required to return an offset chimney back to vertical. Available in stainless steel (KSS) or galvalume (K) outer wall.

15°		6"	7"	8"
A		4"	4 1/4"	4 1/4"
B		3 3/4"	4 1/8"	4 1/4"
GA	ORDER #	6DP-E15K	7DP-E15K	8DP-E15K
	STOCK #	810000525	810000572	810000611
SS	ORDER #	6DP-E15KSS	7DP-E15KSS	8DP-E15KSS
	STOCK #	810000526	810000573	810000612
30°		6"	7"	8"
A		4 1/2"	4 5/8"	5"
B		4 3/4"	4 3/4"	4 3/4"
GA	ORDER #	6DP-E30K	7DP-E30K	8DP-E30K
	STOCK #	810000527	810000574	810000613
SS	ORDER #	6DP-E30KSS	7DP-E30KSS	8DP-E30KSS
	STOCK #	810000528	810000575	810000614

Elbow Strap

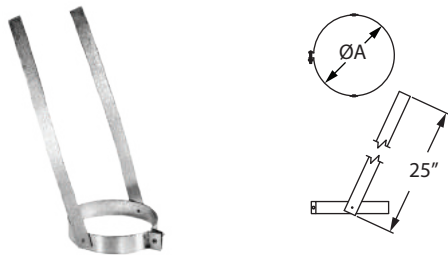

Use to prevent excessive weight on the elbows by supporting the weight of the chimney. Required to be installed between two elbows in offset installations. Multiple elbow straps may be required for offset installations. Refer to installation instructions.

SIZE	6"	7"	8"
A	10"	11"	12"
ORDER #	6DP-ES	7DP-ES	8DP-ES
STOCK #	810000529	810000576	810000615

Round Ceiling Support

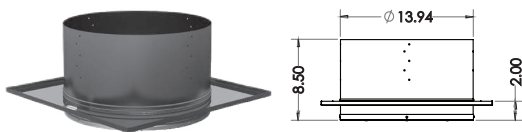

Supports chimney pipe and provides a positive connection between support box and chimney with a built-in twist-lock. Supports up to 35' of DuraPlus Chimney. Use adapter to attach DVL or DuraBlack to the support box. Painted black. Trim collar included. (For adapters see DVL and DuraBlack section.)

SIZE	6"	7"	8"
ORDER #	6DP-RCS	7DP-RCS	8DP-RCS
STOCK #	810000530	810000577	810000616

Square Ceiling Support Box

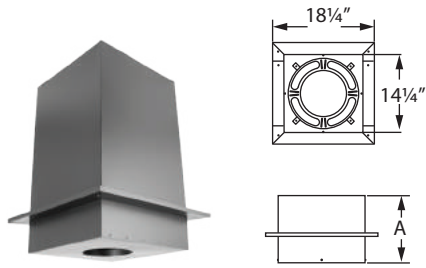

Use with flat, vaulted, or cathedral ceilings. Square Ceiling Support Box is painted black. Refer to Ceiling Pitch table to determine size of support box needed. Supports up to 35' of DuraPlus Chimney. Starter Section built-in. For adapters, see DVL and DuraBlack section. Trim included.

SIZE	6"	7"	8"
A	11"	11"	11"
ORDER #	6DP-CS11	7DP-CS11	8DP-CS11
STOCK #	810000531	810000578	810000617
A	24"	24"	24"
ORDER #	6DP-CS24	7DP-CS24	8DP-CS24
STOCK #	810000532	810000579	810000618
A	36"	36"	36"
ORDER #	6DP-CS36	7DP-CS36	8DP-CS36
STOCK #	810000533	810000580	810000619
CEILING PITCH			
DURABLACK	DVL	USE	
0/12 - 4/12	0/12 - 6/12	11" Support box	
5/12 - 9/12	7/12 - 13/12	24" Support box	
10/12 - 14/12	14/12 - 20/12	36" Support box	

Flat Ceiling Support Box

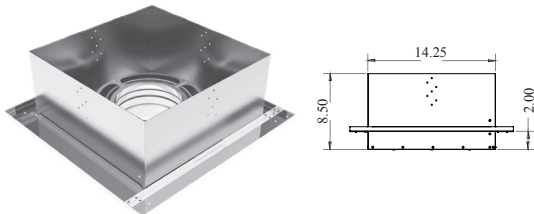

Supports chimney pipe and provides a positive connection between support box and chimney with a built-in twist-lock. Designed for installation in flat ceilings only. Supports up to 35' of DuraPlus chimney pipe. Use adapter to attach DVL or DuraBlack to the support box. A 2" wide trim collar is included. Not painted, but can be painted with high temperature paint. For adapters, see DVL and DuraBlack section.

SIZE	6"	7"	8"
ORDER #	6DP-FCS	7DP-FCS	8DP-FCS
STOCK #	810000534	810000581	810000620

Wall Thimble

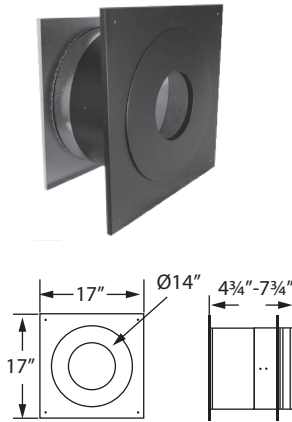

Adjusts from a minimum of 4 1/4" to a maximum of 7 1/4" wall thickness, and fits between standard wall studs. To accommodate thicker walls, the telescoping pieces can be extended up to 16" with a field-fabricated extension installed. Interior trim ring painted black. Must be installed with DuraPlus chimney pipe horizontally through the wall and extend a minimum of 2" into the room beyond the interior wall. For adapters, see DVL and DuraBlack section.

SIZE		6"	7"	8"
GA	ORDER #	6DP-WT	7DP-WT	8DP-WT
	STOCK #	810000535	810000582	810000621
SS	ORDER #	6DP-WTSS	7DP-WTSS	8DP-WTSS
	STOCK #	810000536	810000583	810000622
WHEN USING A WALL THIMBLE				
WALL THICKNESS		INSTALL PIPE SECTION		
4 1/2"		6"		
4 1/2" - 5 1/2"		9"		
5 1/2" - 8 1/2"		12"		
8 1/2" - 13"		(2) 9"		

Tee w/ Cap

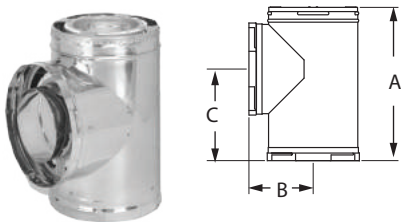

Use for through-the-wall chimney installations. The tee clean-out cap is removable for easy chimney cleaning or inspection. Wall Straps, a Wall Thimble, and a Tee Support must be installed with the Tee as directed. Tees have 1" insulating blanket. Ventilation air for chimney must be drawn from outdoors. (See installation instructions.)

SIZE		6"	7"	8"
A		15 5/16"	17 5/16"	17 1/2"
B		7 1/2"	8"	8 1/2"
C		8 1/4"	8 3/4"	9"
GA	ORDER #	6DP-T	7DP-T	8DP-T
	STOCK #	810000537	810000584	810000623
SS	ORDER #	6DP-TSS	7DP-TSS	8DP-TSS
	STOCK #	810000538	810000585	810000624

Tee Support Bracket

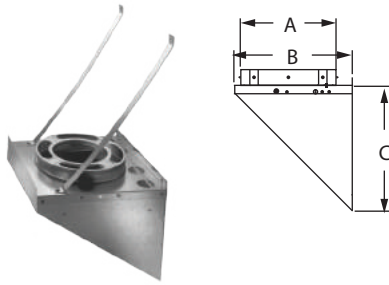

Use to support the Tee; suspended from a wall. Supports up to 35' of DuraPlus Chimney. Starter Section built-in.

SIZE		6"	7"	8"
A		10"	11"	12"
B		14"	15"	16"
C		12"	13"	14"
GA	ORDER #	6DP-TSB	7DP-TSB	8DP-TSB
	STOCK #	810000539	810000586	810000625
SS	ORDER #	6DP-TSBSS	7DP-TSBSS	8DP-TSBSS
	STOCK #	810000540	810000587	810000626

Adjustable Wall Strap

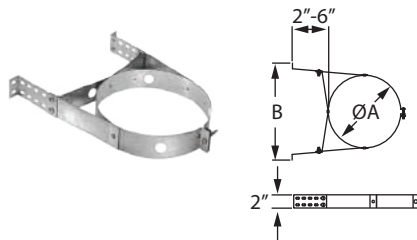

Use in interior or exterior installations to support and to stabilize the chimney while assuring a 2" clearance. Wall straps are required every 4' on exterior of building. Adjusts 2"-6" from wall.

SIZE	6"	7"	8"
A	10"	11"	12"
B	16 1/8"	17 1/8"	18 1/8"
ORDER #	6DP-AWS	7DP-AWS	8DP-AWS
STOCK #	810000547	810000589	810000633

Wall Strap

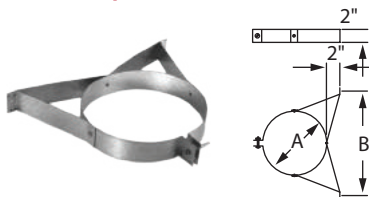

Use in interior or exterior installations to support and to stabilize the chimney while assuring a 2" clearance. Wall straps are required every 4' on exterior of building only.

SIZE		6"	7"	8"
A		10"	11"	12"
B		16"	16"	16"
GA	ORDER #	6DP-WS	7DP-WS	8DP-WS
	STOCK #	810000548	810000590	810000634
SS	ORDER #	6DP-WSSS	7DP-WSSS	8DP-WSSS
	STOCK #	810000549	810000591	810000635

Base Plate

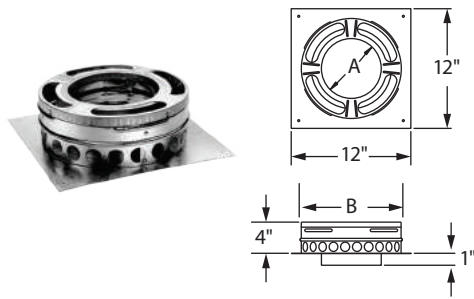

Use to adapt on a zero-clearance fireplace when using DuraPlus directly off the unit. Starter Section built in.

SIZE	6"	7"	8"
A	6"	7"	8"
B	10"	11"	12"
ORDER #	6DP-BP	7DP-BP	8DP-BP
STOCK #	810000541	810000588	810000627

Transition Anchor Plate

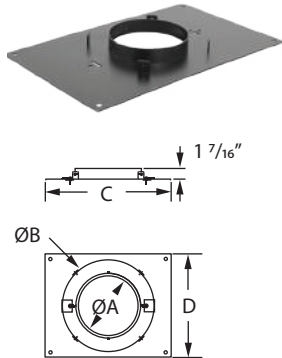

Use Transition Anchor Plate with DuraPlus when extending or converting from DuraLiner to DuraPlus in chimney restoration. Use with DuraLiner Slip Connector and Hanger. (See DuraLiner section.)

SIZE	ORDER #	STOCK #	A	B	C	D
6"	6DP-AP14x17	810000542	6 1/16"	10 3/8"	17"	14"
6"	6DP-AP17x17	810000543	6 1/16"	10 3/8"	17"	17"
6"	6DP-AP13x21	810000544	6 1/16"	10 3/8"	21"	13"
6"	6DP-AP17x21	810000545	6 1/16"	10 3/8"	21"	17"
8"	8DP-AP14x17	810000628	8 1/16"	12 3/8"	17"	14"
8"	8DP-AP17x17	810000629	8 1/16"	12 3/8"	17"	17"
8"	8DP-AP13x21	810000630	8 1/16"	12 3/8"	21"	13"
8"	8DP-AP17x21	810000631	8 1/16"	12 3/8"	21"	17"

Starter Section

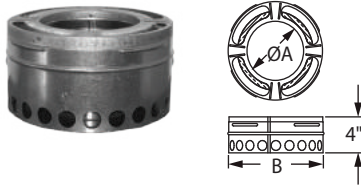

Use only when converting from DuraLiner to DuraPlus and the DuraPlus Chimney is going to be enclosed in a chase. (See DuraLiner installation instructions.)

SIZE	6"	8"
A	6"	8"
B	10"	12"
ORDER #	6DP-SS	8DP-SS
STOCK #	810000546	810000632

Firestop Radiation Shield

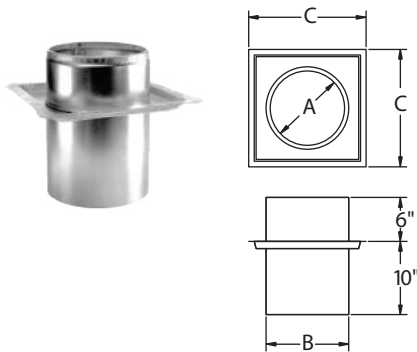

Use in ceiling/floor penetrations when a ceiling support is not used. Not required when passing through the roof. Fits on underside of ceiling and adjusts to cover framing. (See installation instructions for proper placement.)

SIZE	6"	7"	8"
A	10 3/16"	11 3/16"	12 3/16"
B	10 7/8"	11 7/8"	12 7/8"
C	16 1/2"	16 1/2"	16 1/2"
ORDER #	6DP-FRS	7DP-FRS	8DP-FRS
STOCK #	810000550	810000592	810000636

Attic Insulation Shield

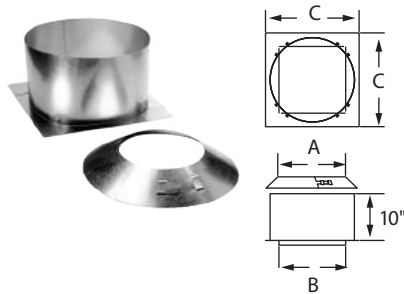

Required for installations that pass through an attic to prevent insulation and debris from accumulating near the chimney. Fits over Firestop Radiation Shield or a support box. Consists of two parts: a collar and a base.

SIZE	6" - 8"
A	10", 11", 12"
B	14 1/4"
C	20"
ORDER #	6DP-IS
STOCK #	810000551

Close Clearance Shield

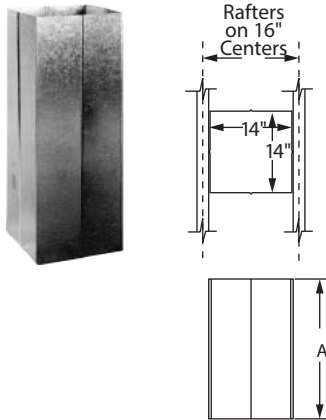

Use in installations where a 7" or 8" DuraVent chimney system passes through a roof opening with less than the normal 2" minimum clearance to roof trusses or rafters. Chimney pipe must be centered within Close Clearance Shield. (See installation instructions.)

SIZE	6" - 8"	6" - 8"	6" - 8"
A	36"	48"	60"
ORDER #	6DP-CCS36	6DP-CCS48	6DP-CCS60
STOCK #	810000552	810000553	810000554

Roof Flashing

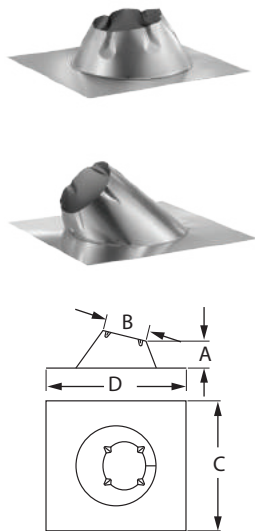

Use to weather proof the penetration of chimney pipe through the roof. Storm Collar required. Select roof flashing based on pitch of roof. For example, a 6/12 pitch has a vertical rise of 6" over a horizontal distance of 12". Made of galvalume.

SIZE		6"	7"	8"
FLAT ROOF	A	10 3/4"	10 3/4"	11"
	B	10 1/2"	11 3/4"	12 3/4"
	C	26"	29 1/2"	29 1/2"
	D	26"	29 1/2"	29 1/2"
	ORDER #	6DP-FF	7DP-FF	8DP-FF
	STOCK #	810000555	810000593	810000637
0/12-6/12 PITCH	A	6"	6"	6"
	B	10 3/4"	11 3/4"	12 3/4"
	C	26"	26"	26"
	D	26"	26"	26"
0/12-6/12	ORDER #	6DP-F6	7DP-F6	8DP-F6
	STOCK #	810000556	810000594	810000638
7/12-12/12	ORDER #	6DP-F12	7DP-F12	8DP-F12
	STOCK #	810000557	810000595	810000639
13/12-18/12	ORDER #	6DP-F18	7DP-F18	8DP-F18
	STOCK #	810000558	810000596	810000640
19/12-24/12	ORDER #	6DP-F24	7DP-F24	8DP-F24
	STOCK #	810000559	810000597	810000641

DSA Roof Flashings



Use with metal or tile roofs. Available in sizes 6" and 8", in 0/12-6/12 (shown) and 7/12-12/12 styles. Made of dead soft aluminum. Refer to Roof Flashing table for dimensions.

SIZE		6"	8"
0/12-6/12	ORDER #	6DP-F6DSA	8DP-F6DSA
	STOCK #	810000560	810000642
7/12-12/12	ORDER #	6DP-F12DSA	8DP-F12DSA
	STOCK #	810000561	810000643

Storm Collar



Required with DuraPlus flashing to create a weather proof penetration through the roof deck. Seal inner edge of the collar to the chimney pipe with non-hardening 500°F high-temperature sealant.

SIZE	6"	7"	8"
A	10"	11"	12"
B	13"	14"	15"
ORDER #	6DP-SC		
STOCK #	810000562		

Extended Roof Bracket

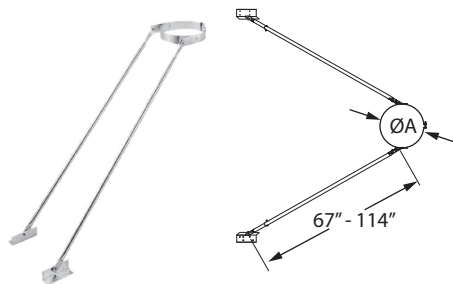

Use to support the chimney when it extends more than 4' above the roof. Provides stability to chimney against wind and snow. Mounting brackets and adjustable legs included.

SIZE	6"	7"	8"
A	10"	11"	12"
ORDER #	6DP-XRB	7DP-XRB	8DP-XRB
STOCK #	810000563	810000598	810000644

Chimney Cap

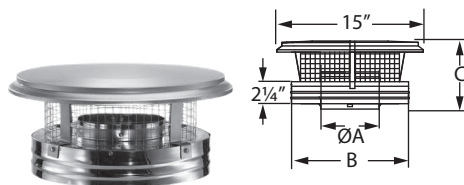

Required where chimney pipe terminates above the roof line. Removable screws allow for cleaning of the chimney and spark arrestor screen. Made of stainless steel.

SIZE	6"	7"	8"
A	6"	7"	8"
B	12"	13"	14"
C	7"	8"	8"
ORDER #	6DP-VC	7DP-VC	8DP-VC
STOCK #	810000564	810000599	810000645

Snow Splitter

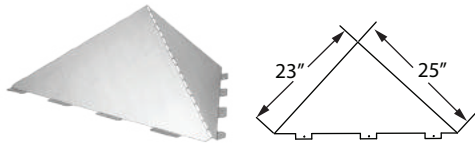

Use to divert snow around chimney, vent, and roof flashing. Constructed of paintable galvanized material. Ships flat for easy assembly. For pricing refer to DuraTech price list.

SIZE	6"
ORDER #	6DT-SP
STOCK #	810000139

Offset Chart

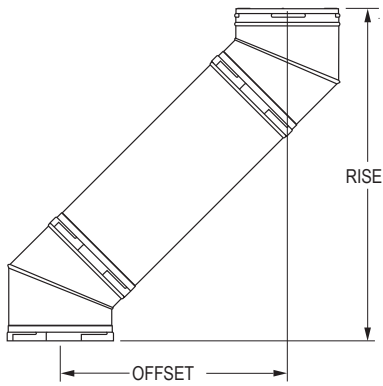

SIZE		6" DIAMETER		7" DIAMETER		8" DIAMETER	
Elbow Degrees	Chimney Section	Offset Inches	Rise Inches	Offset Inches	Rise Inches	Offset Inches	Rise Inches
15°	0"	1 1/2"	12"	1 3/4"	13 1/2"	1 3/4"	15 1/4"
15°	6"	2 3/4"	18"	3"	19 3/8"	3"	19 1/2"
15°	9"	3 1/2"	21"	3 3/4"	22 1/4"	3 3/4"	22 1/2"
15°	12"	4 3/8"	24"	4 1/2"	25 1/8"	4 1/2"	25 1/2"
15°	24"	7 1/2"	35 1/2"	7 3/4"	36 3/4"	7 1/2"	37"
15°	36"	10 1/2"	47"	10 3/4"	48 1/2"	10 3/4"	48 1/2"
15°	24"+24"	13 1/4"	57 1/4"	13 1/2"	58 1/2"	13 1/2"	58 3/4"
30°	0"	3 3/4"	16"	3 3/4"	14 1/4"	3 3/4"	14 3/4"
30°	6"	6"	20"	6"	20"	6 1/2"	20 3/4"
30°	9"	7 1/2"	22 1/2"	7 1/2"	22 3/4"	8"	23 1/4"
30°	12"	9"	25"	9"	24"	9"	24"
30°	24"	15"	35 1/2"	15"	35 3/4"	15 1/4"	36 1/4"
30°	36"	21"	45 3/4"	21"	46"	21 1/4"	46 3/4"
30°	24"+24"	26 3/8"	54 3/4"	26 1/2"	55"	26 3/4"	55 3/4"

Chimney Sizing Chart For Fireplace Installations

