

DuraVent®

DirectVent® Pro

Unitized, co-axial venting system
for direct vent gas or
propane stoves, and fireplaces.



Specifications

Applications

DirectVent Pro is a unitized, coaxial (concentric) venting system designed for use with direct vent gas or propane stoves, heaters, and fireplaces.

Materials and Construction

.020" aluminum inner wall.
.018" galvanized steel outer wall.
Painted outer walls made of laser-welded .018" galvalume steel. Caps also available in stainless steel and copper.
Outer pipe brings combustion air to the appliance. Inner pipe exhausts flue gases to the outside. Gaskets or sealants not required (unless specified by the appliance manufacturer).

Clearances

Specified by the appliance manufacturer.

Diameters

4" x 6 5/8" and 5" x 8".

Listings

DirectVent Pro, in combination with the gas appliance, has been tested and listed as a decorative gas appliance system or as a direct vent heater system by a major testing agency, such as UL, CSA, or Warnock Hersey. Check with your appliance manufacturer for approval.

DirectVent Pro

DirectVent Pro features tight inner connections for superb performance, with no gaskets or sealants required (unless specified by the appliance manufacturer). All black pipe lengths, pipe extensions, and elbows feature laser-welded outer wall seams for a sleek finish. Low-profile locks and no hems or beads allow for a beautiful product that looks elegant in any interior.

DuraVent's direct vent is specified by nearly every major stove and fireplace manufacturer in the U.S. and Canada, with the largest choice of termination caps for direct vent available.



Typical Installations

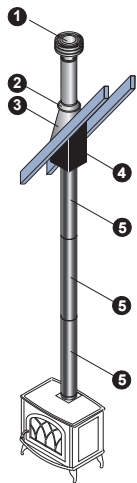

Cathedral Ceiling Stove Installation

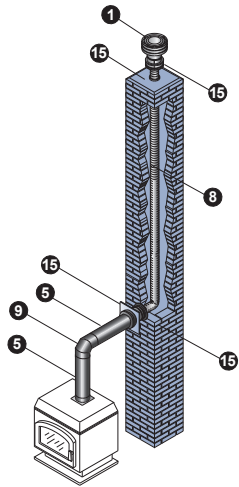

Masonry Chimney Conversion

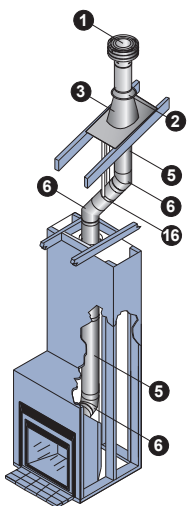

Fireplace Vertical Termination

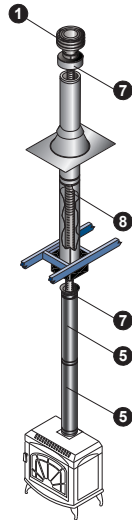

Metal Chimney Conversion

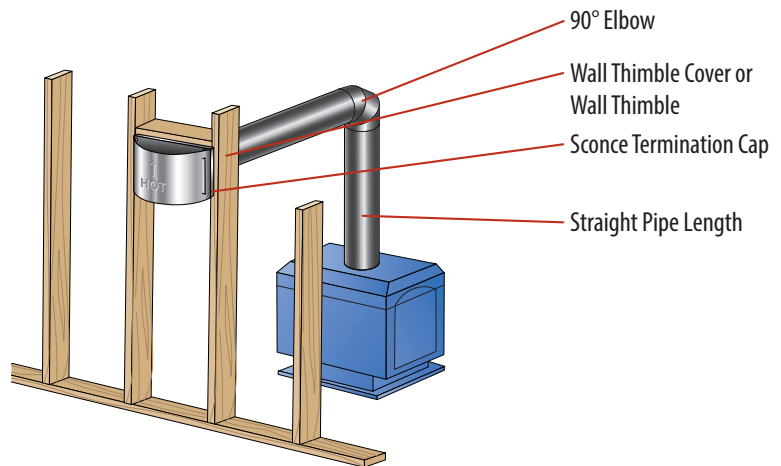

90° Elbow

Wall Thimble Cover or Wall Thimble

Scence Termination Cap

Straight Pipe Length

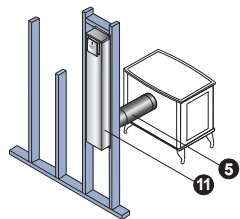

Stove with Snorkel Horizontal Termination

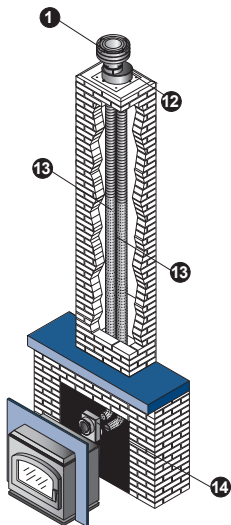

Co-Linear Insert

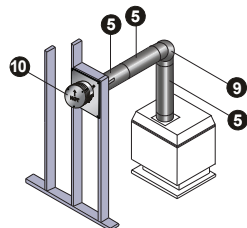

Stove Horizontal Termination

Installation Key

1	Vertical Termination Cap	9	90° Elbow
2	Storm Collar	10	Horizontal Termination Cap
3	Flashing	11	Snorkel Termination Cap
4	Cathedral Ceiling Support Box	12	Colinear Kit
5	Pipe	13	3" or 4" Flex
6	45° Elbow	14	Co-Axial to Co-Linear Connector
7	Class A Chimney Conversion Kit	15	Masonry Chimney Conversion Kit
8	4" Flex	16	Elbow Strap

• Refer to our Typical Venting Installation drawings to select the appropriate component parts for your installation.

Planning Your Installation

1	For vertical gas stove installations, measure the height from the stove outlet to the ceiling to determine the length of black pipe required. Select a ceiling support/wall thimble cover or a cathedral ceiling support box.
2	To determine the length of galvanized pipe required, measure the ceiling thickness and the vertical rise in an attic or second story. Firestops are required at each floor level beyond the first floor ceiling support/wall thimble cover or cathedral ceiling support box. If an offset is required to avoid obstructions, use a pair of 45° elbows. For proper support, use elbow straps with offsets. Use wall straps for long vertical runs. Attic Insulation Shield is required in attic.
3	Measure the roof pitch. Select the proper flashing and storm collar. Determine the minimum height above the roof.
4	For horizontal installations, check the appliance manufacturer's instructions for minimum rise and maximum horizontal run. A snorkel termination may be used if height restrictions prevent adequate rise above the appliance. Select the appropriate Horizontal Termination Cap (see appliance manufacturer installation instructions). To protect vinyl siding, select vinyl siding standoff. Check appliance manufacturer's instructions for wall thimble and firestop requirements.

Design Recommendation

The following design recommendations are general guideline to assist in the design and selection of venting components for your installation. Always follow DuraVent Installation instructions enclosed with the cap or support box before installing your chimney system. Installation instructions can be viewed online at www.duravent.com, under Catalogs and Instructions.

Important: Check the manufacturer's rating plate and instruction manual to confirm that the DuraVent direct vent system is approved for use on the brand name appliance you have selected.

- The inner and outer pipe diameters should match the outlet size of the appliance.
- Check the appliance manufacturer's installation instructions to confirm which types of vent configurations are permitted (i.e. horizontal, vertical, chimney reline, etc.). Also, check for any venting restrictions such as maximum horizontal run, minimum and maximum vertical rise, maximum offset, etc.
- Be fire safe! Maintain at least the minimum clearances (air-space) between the vent pipe and nearby combustibles, as specified in the appliance manufacturer's installation instructions. Use proper support and bracing. Follow local building codes and have your venting system inspected.

Vent Termination Chart

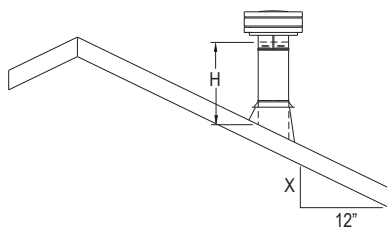

Roof Pitch	Minimum Height	
	Feet	Meters
Flat to 7/12	1	0.30
Over 7/12 to 8/12	1.5	0.46
Over 8/12 to 9/12	2	0.61
Over 9/12 to 10/12	2.5	0.76
Over 10/12 to 11/12	3.25	0.99
Over 11/12 to 12/12	4	1.22
Over 12/12 to 14/12	5	1.52

Horizontal Termination Kit A



Kit includes: 90° black Elbow, Ceiling Support/Wall Thimble Cover, 24" black Pipe, 8 1/2" black Pipe Extension. Termination cap not included. For 4" x 6 5/8" direct vent.

Choose termination cap to complete installation.

SIZE	ORDER #	STOCK #
4" x 6 5/8"	46DVA-KHA	810001267

Horizontal Termination Kit C



Kit includes: 90° black Elbow, Wall Thimble, Ceiling Support/Wall Thimble Cover, 24" black Pipe, 8 1/2" black Pipe Extension. Termination cap not included. For 4" x 6 5/8" direct vent.

Choose termination cap to complete installation.

SIZE	ORDER #	STOCK #
4" x 6 5/8"	46DVA-KHC	810001268

Masonry Chimney Conversion Kit

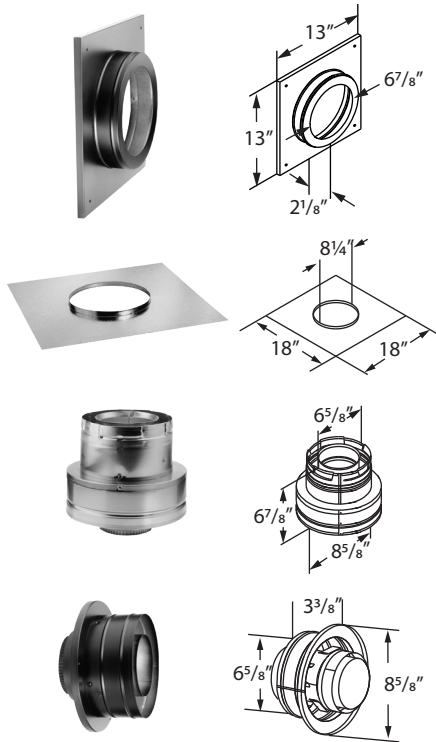

Kit 46DVA-KMC includes: Cap Adapter, 18" x 18" Flashing, Round Ceiling Support/Wall Thimble Cover, Retro Connector. For 4" x 6 5/8" direct vent. Termination Cap and 4" flex are sold separately.

Kit 46DVA-KCT includes: Cap Adapter and a 18" x 18" Flashing.

Use with 4" x 6 5/8" direct vent gas stoves. Use existing masonry chimney. Route the exhaust gases and intake air through the side of the masonry chimney.

SIZE	ORDER #	STOCK #
4" x 6 5/8"	46DVA-KMC	810001274
4" x 6 5/8"	46DVA-KCT	810001275

Chimney Conversion Kit

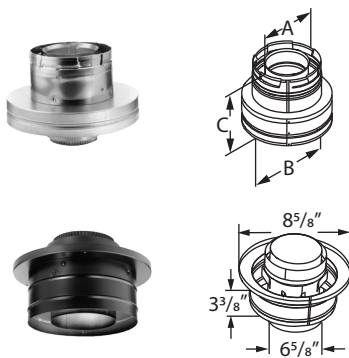

Kits 46DVA-KCA, 46DVA-KCB, and 46DVA-KCC include: Cap Adapter and a Retro Connector. DirectVent Pro 4" x 6 5/8" Termination Cap and 4" flex are sold separately.

Use with 4" x 6 5/8" direct vent gas stoves. Use existing through-the-ceiling, wood-stove metal chimney. Route the exhaust gases and intake air through the existing wood-stove metal chimney.

SIZE	ORDER #	STOCK #	A	B	C
4" x 6 5/8"	46DVA-KCA	810001276	6 5/8"	8 5/8"	6 7/8"
4" x 6 5/8"	46DVA-KCB	810001279	6 5/8"	10 1/2"	5 7/8"
4" x 6 5/8"	46DVA-KCC	810001280	6 5/8"	13"	5 7/8"

46DVA-KCA FITS:	46DVA-KCB FITS:	46DVA-KCC FITS:
SDV 5"-6" DURATECH	SDV 6" DURAPLUS & 7"-8" DURATECH	SDV 7"-8" DURAPLUS
6" SECURITY CHIMNEY	8" SECURITY CHIMNEY	7" & 8" DURAPLUS
6" METALBESTOS	7" & 8" METALBESTOS	8" AMERICAN METALS
6" JACKES-EVANS	7" & 8" JACKES-EVANS	8" AIR-JET
6" HART & COOLEY	7" & 8" HART & COOLEY	8" METAL-FAB
6" PRO JET	7" & 8" PRO JET	
	6" & 7" AMERICAN METALS	
	6" & 7" METAL-FAB	
	6" AIR-JET	

Pipe Length



Designed for appliances tested and listed for direct vent. Features a fully unitized twist-lock construction in both 4" x 6 5/8" and 5" x 8" vent sizes. Use of sealant is optional, unless specified by the appliance manufacturer. To calculate install length, subtract 1 1/2" for each joint. No beads or hems. Black pipe lengths feature exterior laser-welded seams.

SIZE	A	GALVANIZED		BLACK	
		ORDER #	STOCK #	ORDER #	STOCK #
4" x 6 5/8"	6"	46DVA-06	810001281	46DVA-06B	810001282
4" x 6 5/8"	9"	46DVA-09	810001283	46DVA-09B	810001284
4" x 6 5/8"	12"	46DVA-12	810001285	46DVA-12B	810001286
4" x 6 5/8"	18"	46DVA-18	810001289	46DVA-18B	810001290
4" x 6 5/8"	24"	46DVA-24	810001291	46DVA-24B	810001292
4" x 6 5/8"	36"	46DVA-36	810001293	46DVA-36B	810001294
4" x 6 5/8"	48"	46DVA-48	810001295	46DVA-48B	810001296
4" x 6 5/8"	60"	46DVA-60	810001297	46DVA-60B	810001298
5" x 8"	6"	58DVA-06	810001369	58DVA-06B	810001370
5" x 8"	9"	58DVA-09	810001371	58DVA-09B	810001372
5" x 8"	12"	58DVA-12	810001373	58DVA-12B	810001374
5" x 8"	18"	58DVA-18	810001375	58DVA-18B	810001376
5" x 8"	24"	58DVA-24	810001377	58DVA-24B	810001378
5" x 8"	36"	58DVA-36	810001379	58DVA-36B	810001380
5" x 8"	48"	58DVA-48	810001381	58DVA-48B	810001382
5" x 8"	60"	58DVA-60	810001383	58DVA-60B	810001384

Pipe Extension



Use to add length to a straight length of DirectVent Pro. 8 1/2" pipe adds 3" - 7" of length, 16" pipe adds 3" - 14 1/2" of length, when used with rigid sections of pipe. Direct vent lengths feature a fully unitized, twist-lock construction. Use of sealant is optional, unless specified by the appliance manufacturer. Available in black or galvalume exterior (both feature laser-welded outer wall seams). Does not fit DirectVent GS pipe.

SIZE	GALVANIZED		BLACK		A	EXTENSION
	ORDER #	STOCK #	ORDER #	STOCK #		
4" x 6 5/8"	46DVA-08A	810001299	46DVA-08AB	810001300	8 1/2"	3" - 7"
4" x 6 5/8"	46DVA-16A	810001287	46DVA-16AB	810001288	16"	3" - 14 1/2"
5" x 8"	58DVA-08A	810001385	58DVA-08AB	810001386	8 1/2"	3" - 7"
5" x 8"	58DVA-16A	810001387	58DVA-16AB	810001388	16"	3" - 14 1/2"

Adjustable Pipe

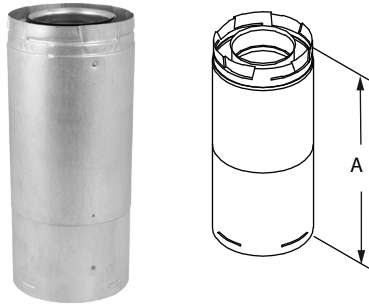

Use of sealant is optional, unless specified by the appliance manufacturer. Available in black or galvalume exterior (both feature laser-welded outer wall seams).

SIZE	GALVANIZED		BLACK		A	INSTALLED
	ORDER #	STOCK #	ORDER #	STOCK #		
4" x 6 5/8"	46DVA-17TA	810001301	46DVA-17TAB	810001302	11" - 17"	9 1/2" - 15 1/2"
4" x 6 3/8"	46DVA-24TA	810001305	46DVA-24TAB	810001306	17" - 24"	15 1/2" - 22 1/2"
5" x 8"	58DVA-17TA	810001389	58DVA-17TAB	810006048	11" - 17"	9 1/2" - 15 1/2"
5" x 8"	58DVA-24TA	810001390	--	--	17" - 24"	15 1/2" - 22 1/2"

30° Elbow

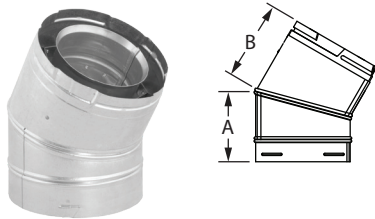

Use to offset obstructions as needed. Fully unitized, twist-lock construction. Elbows swivel, allowing the lock to remain fully engaged while aligning to the desired direction. The angle will remain fixed at 30°.

SIZE	GALVANIZED		A	B
	ORDER #	STOCK #		
4" x 6 5/8"	46DVA-E30	810001307	5 1/4"	4 7/8"
5" x 8"	58DVA-E30	810001391	6 1/8"	5 1/2"

45° Elbow

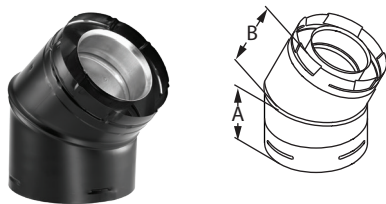

Use to offset obstructions as needed. Fully unitized, twist-lock construction. Elbows swivel, allowing the lock to remain fully engaged while aligning to the desired direction. The angle will remain fixed at 45°.

SIZE	GALVANIZED		BLACK		A	B
	ORDER #	STOCK #	ORDER #	STOCK #		
4" x 6 5/8"	46DVA-E45	810001308	46DVA-E45B	810001309	5 3/4"	5 1/8"
5" x 8"	58DVA-E45	810001393	58DVA-E45B	810001394	6 5/8"	6"

60° Elbow

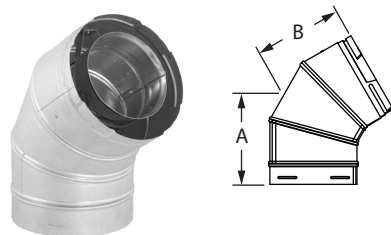

Use to offset obstructions as needed. Fully unitized, twist-lock construction. Elbows swivel, allowing the lock to remain fully engaged while aligning to the desired direction. The angle will remain fixed at 60°.

SIZE	GALVANIZED		A	B
	ORDER #	STOCK #		
4" x 6 5/8"	46DVA-E60	810001310	4 1/4"	4 3/8"
5" x 8"	58DVA-E60	810001392	4 1/4"	4 3/8"

90° Elbow



Use to offset obstructions as needed. Fully unitized, twist-lock construction. Elbows swivel, allowing the lock to remain fully engaged while aligning to the desired direction. The angle will remain fixed at 90°.

SIZE	GALVANIZED		BLACK		A	B
	ORDER #	STOCK #	ORDER #	STOCK #		
4" x 6 5/8"	46DVA-E90	810001311	46DVA-E90B	810001312	6 1/2"	6 1/2"
5" x 8"	58DVA-E90	810001395	58DVA-E90B	810001396	7 3/8"	7 3/8"

Elbow Strap

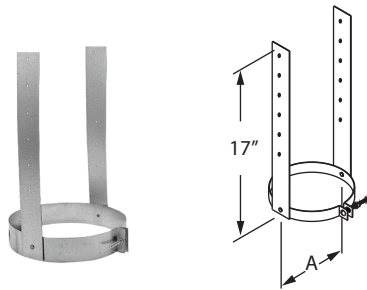

Use for supporting vent pipe between offsets.

SIZE	ORDER #	STOCK #	A
4" x 6 5/8"	46DVA-ES	810001313	6 5/8"
5" x 8"	58DVA-ES	810001397	8"

Decorative Cover

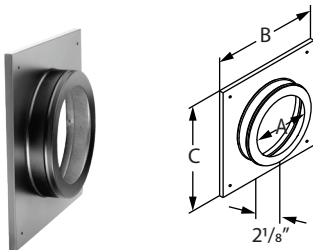

Use as a decorative cover for horizontal (through-wall) installations Fits over the Wall Thimble face plate. Also used to cover a Ceiling Support Box. Comes with an insulation ring to reduce air infiltration where the pipe slips through the thimble. Painted black.

SIZE	ORDER #	STOCK #	A	B	C
4" x 6 5/8"	46DVA-DC	810001314	6 7/8"	13"	13"
5" x 8"	58DVA-DC	810001398	8 1/4"	13"	13"

Cathedral Ceiling Support Box

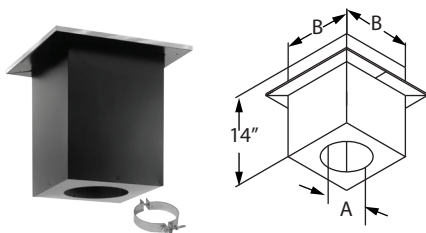

Use to pass through ceiling and support pipe. May be used on vaulted or flat ceilings. Painted black. Trim and clamp included.

SIZE	ORDER #	STOCK #	A	B
4" x 6 5/8"	46DVA-CS	810001315	6 7/8"	10 5/8"
5" x 8"	58DVA-CS	810001399	8 1/4"	10 5/8"

Wall Thimble

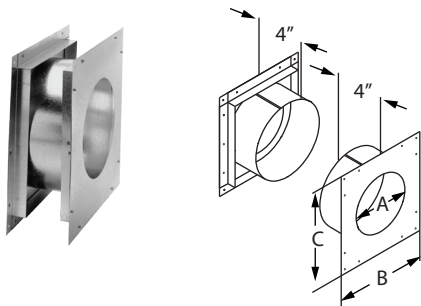

Provides a complete wall-pass-through and firestop. Use with Square Horizontal Cap only. May be required in Canada. Refer to the appliance manufacturer's installation instructions for requirements.

SIZE	ORDER #	STOCK #	A	B	C
4" x 6 5/8"	46DVA-WT	810001316	6 3/4"	11"	12"
5" x 8"	58DVA-WT	810001400	8 1/4"	12 1/2"	12 1/2"

Wall Thimble - Small

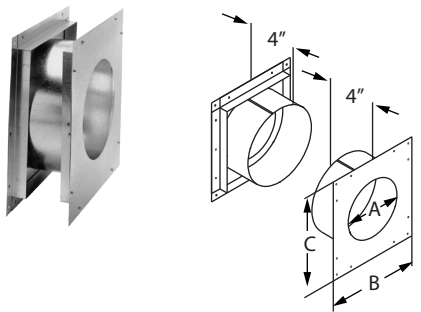

Provides a complete wall-pass-through and firestop. Use with Round Horizontal Cap, Sconce Cap and H2 Horizontal Cap only. May be required in Canada. Refer to the appliance manufacturer's installation instructions for requirements.

SIZE	ORDER #	STOCK #	A	B	C
4" x 6 5/8"	46DVA-WTS	810001317	6 3/4"	11"	11"
5" x 8"	58DVA-WTS	810001401	8 1/4"	11"	11"

Universal Wall Thimble

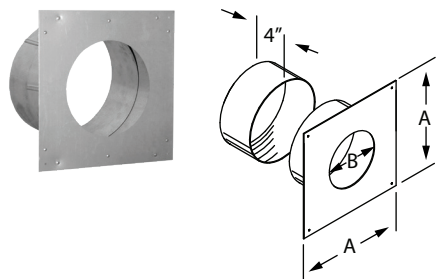

Provides a complete wall-pass-through and interior firestop. Features an adjustable sleeve for an exact fit. Eliminates visible trim on exterior or wall near cap. Sized to fit all DuraVent DirectVent Pro's termination caps. Works well for smaller square and sconce termination caps.

SIZE	ORDER #	STOCK #	A	B
4" x 6 5/8"	46DVA-WTU	810001318	11"	6 3/4"
5" x 8"	58DVA-WTU	810001402	11"	8 1/8"

Wall Firestop

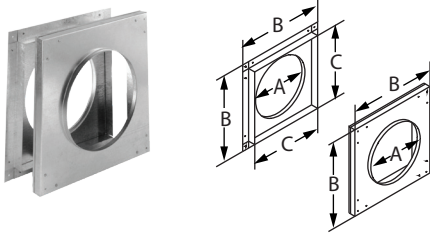

For horizontal (through-wall) installations. Refer to the appliance manufacturer's installation instructions for requirements.

SIZE	ORDER #	STOCK #	A	B	C
4" x 6 5/8"	46DVA-WFS	810001319	6 3/4"	12"	10"
5" x 8"	58DVA-WFS	810001403	8 1/4"	12"	10"

Wall Firestop 2

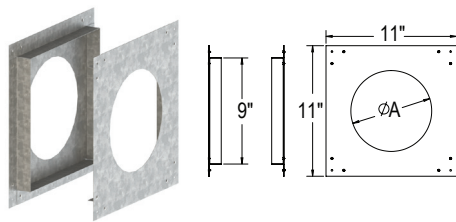

For horizontal (through-wall) installations. Refer to the appliance manufacturer's installation instructions for requirements.

SIZE	ORDER #	STOCK #	A
4" x 6 5/8"	46DVA-WFS2	810013110	6 3/4"
5" x 8"	58DVA-WFS2	810013111	8 1/4"

Vinyl Siding Standoff

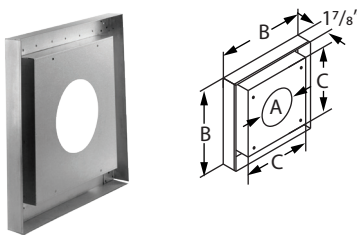

Use as a heat shield on structures with vinyl siding, or other temperature sensitive materials, to help prevent warping and or melting of the material. Use only on horizontal terminations and on any irregular surfaced siding (ie: ship lap siding, shake shingle siding) so cap is not imbedded in the siding. Sized for Square Horizontal Cap.

SIZE	ORDER #	STOCK #	A	B	C
4" x 6 5/8"	46DVA-VSS	810001320	6 3/4"	17 1/2"	13 1/2"
5" x 8"	58DVA-VSS	810001404	8 1/4"	19 7/8"	15 3/4"

Vinyl Siding Standoff Kit

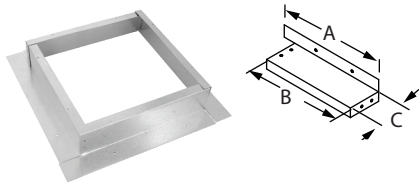

Use as a heat shield on structures with vinyl siding, or other temperature sensitive materials, to help prevent warping and or melting of the material. Use only on horizontal terminations and on any irregular surfaced siding (ie: ship lag siding, shake shingle siding) so cap is not imbedded in the siding. Kit includes 4-pieces; sized for Square Horizontal Cap only. Stainless steel (SS) and Copper (C) available.

SIZE	ORDER #	STOCK #	A	B	C
4" x 6 5/8"	46DVA-VSK	810001321	15 1/4"	13 1/4"	3"
4" x 6 5/8"	46DVA-VSK-SS	810001322	15 1/4"	13 1/4"	3"
4" x 6 5/8"	46DVA-VSK-C	810001326	15 1/4"	13 1/4"	3"
5" x 8"	58DVA-VSK	810001405	17 7/8"	15 7/8"	3"
5" x 8"	58DVA-VSK-SS	810001407	17 7/8"	15 7/8"	3"
5" x 8"	58DVA-VSK-C	810001406	17 7/8"	15 7/8"	3"

Vinyl Siding Standoff Kit - Small

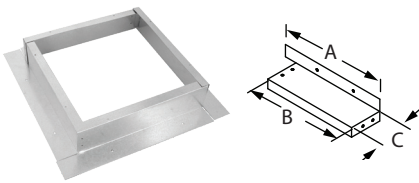

Use as a heat shield on structures with vinyl siding, or other temperature sensitive materials, to help prevent warping and or melting of the material. Use only on horizontal terminations and on any irregular surfaced siding (ie: ship lag siding, shake shingle siding) so cap is not imbedded in the siding. Kit includes 4-pieces; sized for Sconce Cap, Round Horizontal Cap and H2 Horizontal Cap only. Stainless steel (SS) and Copper (C) available. Use for 4"x 6 5/8" and 5"x 8" diameters.

SIZE	ORDER #	STOCK #	A	B	C
4" x 6 5/8"	46DVA-VSKS	810001323	12 7/8"	10 7/8"	3"
4" x 6 5/8"	46DVA-VSKS-SS	810001325	12 7/8"	10 7/8"	3"
4" x 6 5/8"	46DVA-VSKS-C	810001327	12 7/8"	10 7/8"	3"

Vinyl Siding Standoff Box

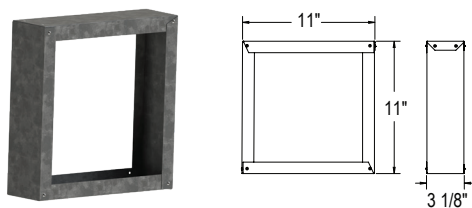

Use as a heat shield on structures with vinyl siding, or other temperature sensitive materials, to help prevent warping and or melting of the material. Use only on horizontal terminations and on any irregular surfaced siding (ie: ship lag siding, shake shingle siding) so cap is not imbedded in the siding. Sized for Sconce Cap, Round Horizontal Cap and H2 Horizontal Cap only. Factory assembled. Use for 4"x 6 5/8" and 5"x 8" diameters.

SIZE	ORDER #	STOCK #
4" x 6 5/8" & 5" x 8"	DVA-BVS	810012706

Counter Flashing

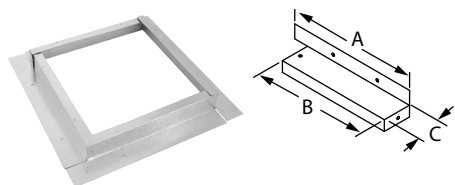

Prevents water intrusion into stucco-sided homes. Allows the installer to apply siding material (ie: stucco, brick, etc) over the flanges up to the sides of the flashing for a water-tight seal. Kit includes 4-pieces; sized for Square Horizontal Cap only.

SIZE	ORDER #	STOCK #	A	B	C
4" x 6 5/8"	46DVA-CFK	810001339	15 1/4"	13 1/4"	2"
4" x 6 5/8"	46DVA-CFK-S	810001342	15 1/4"	13 1/4"	2"
5" x 8"	58DVA-CFK	810001417	17 7/8"	15 7/8"	2"

Counter Flashing - Small

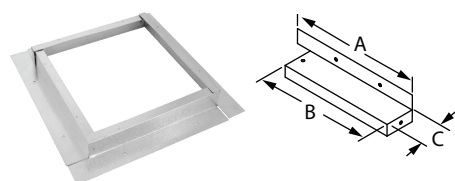

Prevents water intrusion into stucco-sided homes. Allows the installer to apply siding material (ie: stucco, brick, etc) over the flanges up to the sides of the flashing for a water-tight seal. Kit includes 4-pieces; sized for 4" x 6 5/8" Sconce Cap, Round Horizontal Cap and H2 Horizontal Cap only. Also available in stainless steel (S). Use for 4" x 6 5/8" and 5" x 8" diameters.

SIZE	ORDER #	STOCK #	A	B	C
4" x 6 5/8"	46DVA-CFKS	810001341	12 7/8"	10 7/8"	2"
4" x 6 5/8"	46DVA-CFKS-S	810001340	12 7/8"	10 7/8"	2"

Ceiling Firestop

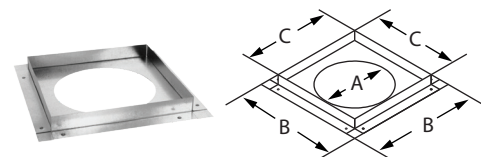

Required for multi-story vertical installations at the second floor and any subsequent floors. 4" x 6 5/8" style may vary.

SIZE	ORDER #	STOCK #	A	B	C
4" x 6 5/8"	46DVA-FS	810001328	6 3/4"	11"	9"
5" x 8"	58DVA-FS	810001408	8 1/4"	12 1/2"	10 1/2"

Attic Insulation Shield

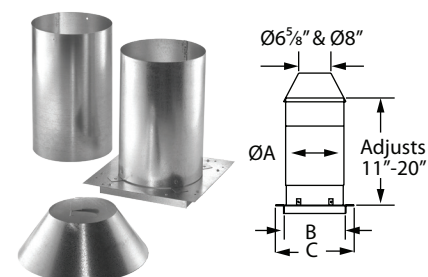

Required for installations that pass through an attic to prevent insulation and debris from accumulating near the vent. Provides 1" clearance to combustibles. Includes base w/tube, extension tube and collar.

SIZE	ORDER #	STOCK #	A	B	C
4" x 6 5/8"	46DVA-IS	810001329	8 3/4"	8 15/16"	11"
5" x 8"	58DVA-IS	810001409	10 3/4"	10 15/16"	13"

Wall Strap

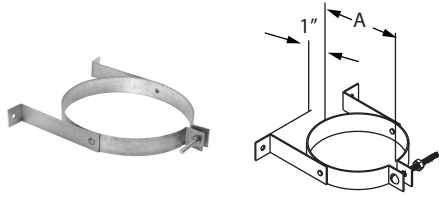

Use to support vent pipe. Provides 1" clearance. Recommend installing Wall Straps at 4-foot intervals on vertical runs.

SIZE	ORDER #	STOCK #	A
4" x 6 5/8"	46DVA-WS	810001330	6 5/8"
5" x 8"	58DVA-WS	810001410	8"

Restrictor Disk

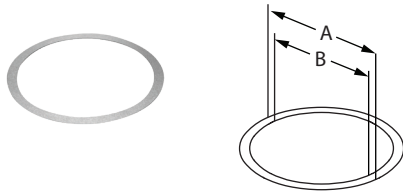

Use only in accordance with specific appliance manufacturer's installation instructions to restrict incoming combustion air.

SIZE	ORDER #	STOCK #	A	B
4" x 6 5/8"	46DVA-RD	810001331	5 1/4"	4 9/16"
5" x 8"	58DVA-RD	810001411	7"	6"

Roof Support

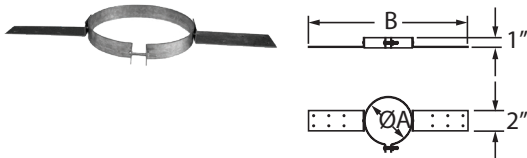

Use to support DirectVent pipe at roof level.

SIZE	ORDER #	STOCK #	A	B
4" x 6 5/8"	46DVA-RS	810013975	6 5/8"	17 3/4"
5" x 8"	58DVA-RS	810013976	8"	19 1/8"

Adjustable Roof Flashing

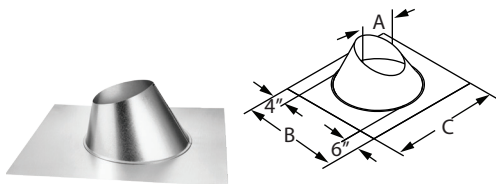

Use to weather proof the penetration of vent pipe through the roof. Storm Collar required. Select roof flashing based on pitch of roof. For pitches of 0/12 - 6/12. Made of galvalume.

SIZE	ORDER #	STOCK #	A	B	C
4" x 6 5/8"	46DVA-F6	810001332	6 3/4"	19 1/4"	19 1/4"
5" x 8"	58DVA-F6	810001412	8 1/2"	21 1/2"	21 1/2"

Steep Roof Flashing

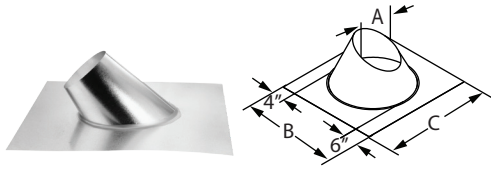

Use to weather proof the penetration of vent pipe through the roof. Storm Collar required. For roof pitches of 7/12 - 12/12. Made of galvalume.

SIZE	ORDER #	STOCK #	A	B	C
4" x 6 5/8"	46DVA-F12	810001333	6 3/4"	21 1/2"	19 1/4"
5" x 8"	58DVA-F12	810001413	8 1/2"	23 1/2"	21 1/2"

Flat Roof Flashing

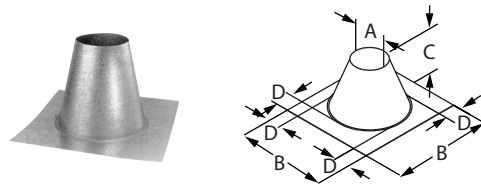

Use to weather proof the penetration of vent pipe through the roof. Storm Collar required. Use on flat roofs, chase enclosures, or masonry chimney. Made of galvalume.

SIZE	ORDER #	STOCK #	A	B	C	D
4" x 6 5/8"	46DVA-FF	810001334	6 3/4"	21 1/2"	12"	4"
5" x 8"	58DVA-FF	810001414	8 1/2"	21 1/2"	12"	4"

Dead Soft Aluminum Flashings

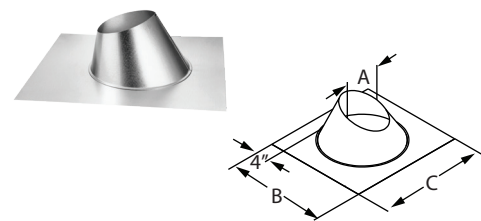

Use with metal or tile roofs. Available in sizes 4"x 6 5/8" and 5"x 8", in 0/12-6/12 (shown) and 7/12-12/12 styles. Made of malleable dead soft aluminum. Refer to roof flashings tables (previous page) for dimensions.

SIZE	STYLE	ORDER #	STOCK #	A	B	C
4" x 6 5/8"	0/12-6/12	46DVA-F6DS	810001335	6 3/4"	27 1/2"	24"
4" x 6 5/8"	7/12-12/12	46DVA-F12DS	810001336	8 3/4"	22"	25"
5" x 8"	0/12-6/12	58DVA-F6DS	810001415	8 1/2"	29 1/2"	24"
5" x 8"	7/12-12/12	58DVA-F12DS	810001416	8 1/2"	24 3/4"	27"

Storm Collar

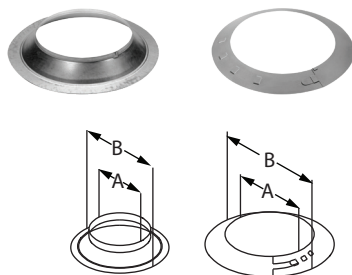

Use to maintain a weather tight resistant seal between the pipe and the flashing.

SIZE	ORDER #	STOCK #	A	B
4" x 6 5/8"	46DVA-SC	810001343	6 5/8"	10 5/8"
5" x 8"	58DVA-SC	810001419	8"	12"

Round Horizontal Termination Cap

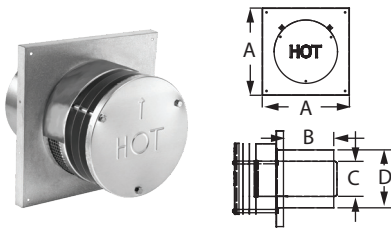

Use for through-the-wall termination. Check installation instructions for restrictions on horizontal cap terminations, such as minimum distance from windows and doors. Available in aluminum only. Check with appliance manufacturer for approval.

SIZE	ORDER #	STOCK #	A	B	C	D
4" x 6 5/8"	46DVA-HRCS	810001344	11"	5 3/4"	4"	6 5/8"
5" x 8"	58DVA-HRCS	810001420	11"	5 3/4"	4 15/16"	8 1/8"

Sconce Termination Cap

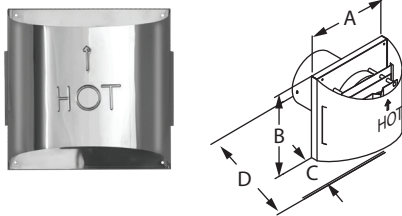

Use for horizontal through-the-wall termination. Check installation instructions for restrictions on horizontal cap terminations, such as minimum distance from windows and doors. Available in aluminum, stainless steel (S), and copper (C). Check with appliance manufacturer for approval. Patented.

SIZE	ORDER #	STOCK #	A	B	C	D
4" x 6 5/8"	46DVA-HSC	810001345	11 1/16"	11"	6 3/8"	12 3/8"
4" x 6 5/8"	46DVA-HSC-S	810001346	11 1/16"	11"	6 3/8"	12 3/8"
4" x 6 5/8"	46DVA-HSC-C	810001347	11 1/16"	11"	6 3/8"	12 3/8"
5" x 8"	58DVA-HSC	810001421	11 1/16"	11"	6 3/8"	12 3/8"
5" x 8"	58DVA-HSC-S	810001422	11 1/16"	11"	6 3/8"	12 3/8"
5" x 8"	58DVA-HSC-C	810001423	11 1/16"	11"	6 3/8"	12 3/8"

High-Wind Sconce Termination Cap

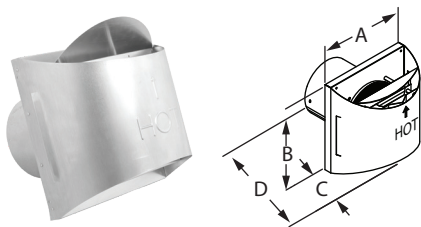

Use for horizontal through-the-wall termination. Provides improved performance in high wind conditions. Check installation instructions for restrictions on horizontal cap terminations, such as minimum distance from windows and doors. Available in aluminum, stainless steel (S), and copper (C). Check with appliance manufacturer for approval. Patented. Includes heat deflector that may be required by appliance manufacturer.

SIZE	ORDER #	STOCK #	A	B	C	D
4" x 6 5/8"	46DVA-HSCH	810001348	11 1/16"	11"	6 3/8"	12 3/8"
4" x 6 5/8"	46DVA-HSCH-S	810001349	11 1/16"	11"	6 3/8"	12 3/8"
4" x 6 5/8"	46DVA-HSCH-C	810001350	11 1/16"	11"	6 3/8"	12 3/8"
5" x 8"	58DVA-HSCH	810001424	11 1/16"	11"	6 3/8"	12 3/8"
5" x 8"	58DVA-HSCH-S	810001425	11 1/16"	11"	6 3/8"	12 3/8"
5" x 8"	58DVA-HSCH-C	810001426	11 1/16"	11"	6 3/8"	12 3/8"

Square Horizontal Termination Cap

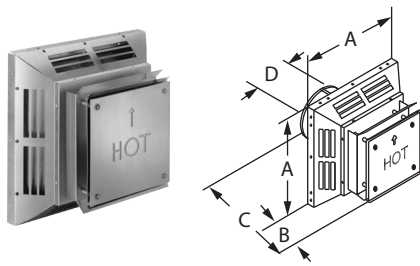

Use for standard and high-wind through-the-wall termination. Check installation instructions for restrictions on horizontal cap terminations, such as minimum distance from windows and doors. Available in aluminum, stainless steel (S), and copper (C).

SIZE	ORDER #	STOCK #	A	B	C	D
4" x 6 5/8"	46DVA-HC	810001351	13 1/2"	6 7/8"	12 1/2"	6 5/8"
4" x 6 5/8"	46DVA-HC-S	810001352	13 1/2"	6 7/8"	12 1/2"	6 5/8"
4" x 6 5/8"	46DVA-HC-C	810001353	13 1/2"	6 7/8"	12 1/2"	6 5/8"
5" x 8"	58DVA-HC	810001427	16"	6 7/8"	12 1/2"	8 1/8"
5" x 8"	58DVA-HC-S	810001428	16"	6 7/8"	12 1/2"	8 1/8"
5" x 8"	58DVA-HC-C	810001429	16"	6 7/8"	12 1/2"	8 1/8"

Square Horizontal H2 Termination Cap



Use for standard and high-wind through-the-wall termination. Provides improved performance in high wind conditions. Features an adjustable air intake and interchangeable shroud (shroud is included and required for all installations). Check installation instructions for restrictions on horizontal cap terminations, such as minimum distance from windows and doors. Available with aluminum shroud. Check with appliance manufacturer for approval and air throttle setting. May be painted at installation to match the wall. Patent Pending.

Termination Cap with AL Shroud			
SIZE	ORDER #	STOCK #	A
4" x 6 5/8"	46DVA-H2	810012624	6 3/4"
5" x 8"	58DVA-H2	810012625	8 1/8"

Alternate / Replacement Shroud			
SIZE	ORDER #	STOCK #	Material
4" x 6 5/8" & 5" x 8"	DVA-TR-AL	810013071	Aluminum
	DVA-TR-SS	810013072	Stainless Steel

Snorkel Termination Cap

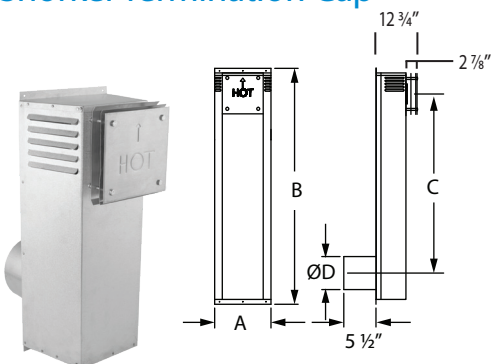

Use for horizontal through-the-wall termination when a vertical rise is desired in the system to meet appliance manufacturer recommended minimum heights. Do not enclose in the wall or install below grade.

SIZE	ORDER #	STOCK #	A	B	C
4" x 6 5/8"	46DVA-SNK14	810001355	10"	23 3/4"	14"
4" x 6 5/8"	46DVA-SNK36	810001356	10"	45 3/4"	36"
5" x 8"	58DVA-SNK14	810001430	10"	23 3/4"	14"
5" x 8"	58DVA-SNK36	810001431	10"	45 3/4"	36"

Snorkel H2 Termination Cap

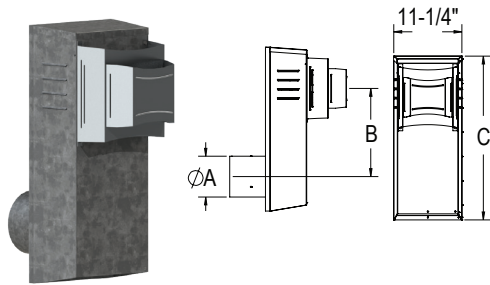

Use for horizontal through-the-wall termination when a vertical rise is desired in the system to meet appliance manufacturer recommended minimum heights. Do not enclose in the wall or install below grade. Provides improved performance in high wind conditions. Features an adjustable air intake and interchangeable shroud (shroud is included and required for all installations). Check with appliance manufacturer for approval and air throttle setting. Patent Pending.

SIZE	ORDER #	STOCK #	A	B	C
4" x 6 5/8"	46DVA-H2-SNK14	810012915	6 3/4"	14 1/2"	27"
4" x 6 5/8"	46DVA-H2-SNK36	810012916	6 3/4"	37"	49 1/2"
5" x 8"	58DVA-H2-SNK14	810012917	8 1/8"	15"	28"
5" x 8"	58DVA-H2-SNK36	810012918	8 1/8"	37 1/2"	50 1/2"

Horizontal Windguard

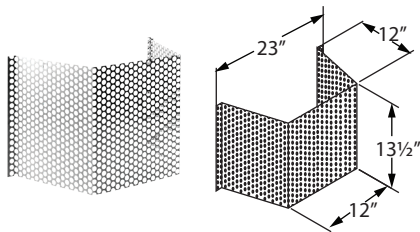

Use with through-the-wall termination cap where high winds are present. Also use as a safety heat shield to prevent children or others from coming into contact with the vent termination cap. Fits both 4" x 6 5/8" and 5" x 8" terminations.

SIZE	ORDER #	STOCK #
4" x 6 5/8" & 5" x 8"	46DVA-WG	810001357

High-Wind Termination Cap

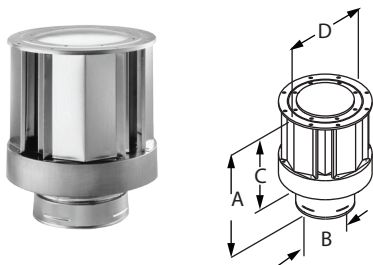

Use for vertical terminations only. Provides improved performance in high wind conditions. For vertical terminations only. Available in aluminum.

SIZE	ORDER #	STOCK #	A	B	C	D
4" x 6 5/8"	46DVA-VCH	810001359	12 3/8"	6 5/8"	7 5/8"	10 1/2"
5" x 8"	58DVA-VCH	810001432	12 3/8"	8"	7 5/8"	10 1/2"

Vertical Wind Guard

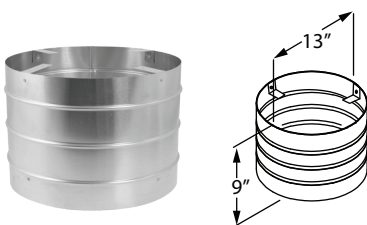

Use only with High Wind Termination Cap when additional wind protection is needed. Fits both 4" x 6 5/8" and 5" x 8" terminations.

SIZE	ORDER #	STOCK #
4" x 6 5/8"	46DVA-VWG	810001358

Low-Profile Termination Cap

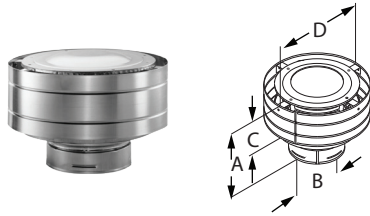

Use for vertical terminations only. Check the appliance manufacturer's instructions to determine which caps are approved for use with their appliance. Available in aluminum and stainless steel (S).

SIZE	ORDER #	STOCK #	A	B	C	D
4" x 6 5/8"	46DVA-VC	810001360	8 1/4"	6 5/8"	3 1/4"	12 1/2"
4" x 6 5/8"	46DVA-VC-S	810001361	8 1/4"	6 5/8"	3 1/4"	12 1/2"
5" x 8"	58DVA-VC	810001433	8 5/8"	8"	7 5/8"	12 1/2"
5" x 8"	58DVA-VC-S	810001434	8 5/8"	8"	7 5/8"	12 1/2"

Extended Vertical Termination Cap

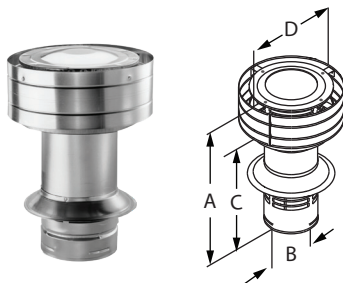

Use in extremely cold climates. Similar to the Low Profile Termination Cap but taller in overall height to separate the air intake vents from the exhaust area. Refer to the appliance manufacturer's installation instructions for requirements. Available in aluminum.

SIZE	ORDER #	STOCK #	A	B	C	D
4" x 6 5/8"	46DVA-VCE	810001362	16 3/4"	6 5/8"	11 3/4"	12 1/2"
5" x 8"	58DVA-VCE	810001435	16 3/4"	8"	11 1/8"	14 1/2"

Aluminum Flex Length



Use 3" flex with the co-linear system and 4" flex with Conversion Kits. See DuraFlex AL section for more information. Flexible .010" thick 2-ply aluminum. Pricing for Aluminum Flex Length are listed under DuraFlex AL.

SIZE	LENGTH	ORDER #	STOCK #
3"	35'	3DFA-35	810002988
4"	35'	4DFA-35	810002998

Flex Coupling

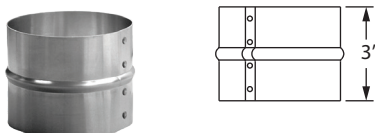

Use to join flex liner sections together. Pricing for Aluminum Flex Length are listed under DuraFlex AL.

SIZE	ORDER #	STOCK #
3"	3DFA-FC	810002992
4"	4DFA-FC	810003000

NEW

Co-Axial To Co-Linear Appliance Connector

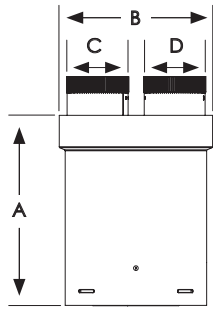

Co-Linear Adapter for use with appliances with 4" X 6 5/8" co-axial outlets. Comes pre-painted in black for use with free-standing stoves. Where desired, the 46DVA-DC Ceiling Support / Wall Thimble Cover can also be used as décor trim. Refer to appliance manufacturer's installation instructions for approval. Uses aluminum flex for both intake and exhaust.

CAP SIZE	ORDER #	STOCK #	EXHAUST	INTAKE	A	B	C	D
4" x 6 5/8"	46DVA-CLAA	810014141	3"	3"	8 7/8"	7 1/8"	3"	3"
4" x 6 5/8"	46DVA-34CLAA	810014339	4"	3"	8 7/8"	8 1/4"	4"	3"

Co-Axial To Co-Linear Appliance Connector

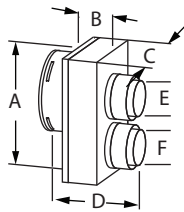
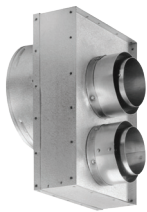

Use Co-Linear Adapter for stoves with 4" X 6 5/8" co-axial outlets. Refer to appliance manufacturer's installation instructions for approval. Uses aluminum flex for both intake and exhaust.

SIZE	CONNECTOR	ORDER #	STOCK #	A	B	C	D	E	F
4" x 6 5/8"	STANDARD	46DVA-GCL	810001363	10 1/2"	3"	7 1/2"	7 1/8"	3"	3"
4" x 6 5/8"	STANDARD	46DVA-GCL34	810004565	10 1/2"	3"	7 1/2"	7 1/8"	4"	3"
4" x 6 5/8"	TRAVIS INDUSTRIES	46DVA-TCL	810001364	10 1/2"	3"	7 1/2"	6 3/8"	3"	3"
4" x 6 5/8"	VERMONT CASTINGS	46DVA-VCL	810001365	10 1/2"	3"	7 1/2"	8 5/8"	3"	3"

NEW

Chimney Liner Termination Kit

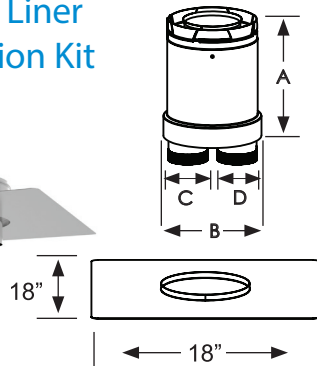
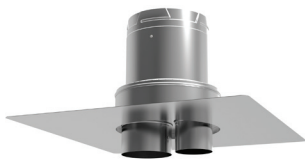

Kit includes: Termination Connector and Top-Plate Flashing. DirectVent Pro 4" x 6 5/8" Termination Caps, 3" Flex, and Co-Linear Flex Connectors are sold separately. DirectVent Pro chimney liner termination kit must be tested and listed for each appliance. Refer to stove manufacturer's installation instructions.

CAP SIZE	ORDER #	STOCK #	EXHAUST	INTAKE	A	B	C	D
4" x 6 5/8"	46DVA-CLTA	810014142	3"	3"	8 7/8"	7 1/8"	3"	3"
4" x 6 5/8"	46DVA-34CLTA	810014340	4"	3"	8 7/8"	8 1/4"	4"	3"

Chimney Liner Termination Kit

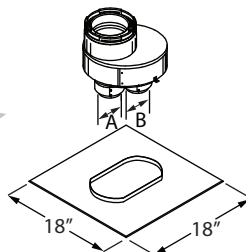
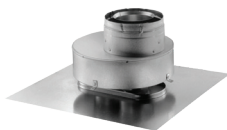

Kit includes: Termination Connector and Flashing. DirectVent Pro 4" x 6 5/8" Termination Caps, 3" Flex, and Co-Linear Flex Connectors are sold separately.

DirectVent Pro chimney liner termination kit must be tested and listed for each appliance. Refer to stove manufacturer's installation instructions.

SIZE	ORDER #	STOCK #	ØA	ØB
4" x 6 5/8"	46DVA-GK	810001269	3"	3"
4" x 6 5/8"	46DVA-CT	810001368	4"	3"

Appliance Adapter

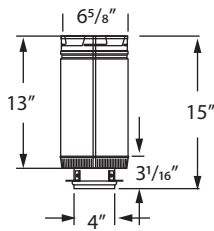

Attaches to appliance outlet allowing pipe to easily connect or disconnect. Vermont Castings adapter #2768.

SIZE	ORDER #	STOCK #
4" x 6 3/8"	46DVA-ADP	810001366

Reducer

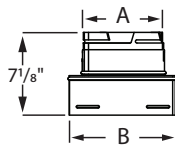

Use to reduce vent diameter. Check with appliance manufacturer for approval.

SIZE	REDUCE TO	ORDER #	STOCK #	A	B
5" X 8"	4" x 6 3/8"	58DVA-X46	810001436	6 5/8"	8"
6" X 8 3/8"	5" X 8"	68DVS-X58	810006145	8"	8 5/8"

DVA to CVS Adapter

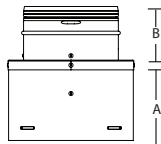

Reducing adapter to transition from our standard DVA twist-lock connection to 3x5 co-axial CVS pipe on gas fireplaces that would otherwise be vented with DirectVent Pro 46DVA or 58DVA venting. This solution combines the installation flexibility of power venting, while reducing the required vent space, allowing for longer vent runs in challenging installations.

SIZE	REDUCE TO	ORDER #	STOCK #	A	B
46DVA	CVS	46DVA-X35CVS	810016992	4"	3"
58DVA	CVS	58DVA-X35CVS	810016994	4"	3"

CVS to DVA Adapter

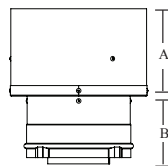

Increasing adapter to transition from our CVS twist-lock connection to 4x6 or 5x8 DVA slip connection. Used for direct vent applications when CVS pipe is used for the run, but the installer wants to terminate with a DVA termination. Screws are needed to secure the slip connection.

SIZE	REDUCE TO	ORDER #	STOCK #	A	B
CVS	46DVA	35CVS-X46DVA	810016993	4"	3"
CVS	58DVA	35CVS-X58DVA	810016997	4"	3"

Co-Linear Flex Connector

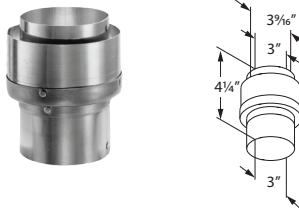

Use as a flex connector with inserts with 3" co-linear intake and exhaust ports.

SIZE	ORDER #	STOCK #
4" x 6 5/8"	46DVA-ADF	810001367

Co-Linear Kit w/ Flex

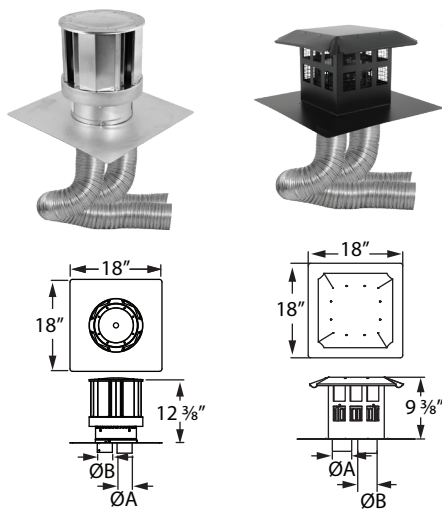

Use when installing a direct vent co-linear insert into a masonry chimney.

Kit includes: Choice of High-Wind Termination Cap or Prairie Termination Cap; and two pieces of Aluminum Flex lengths - one Red (exhaust), and one Green (air intake). See chart for diameters and lengths.

CAP SIZE	ORDER #	STOCK #	A (RED FLEX EXHAUST)	B (AIR INTAKE)	CAP STYLE
4" x 6 5/8"	46DVA-CL33-25	810014029	3" x 25'	3" x 25'	HIGH-WIND
4" x 6 5/8"	46DVA-CL33	810001270	3" x 35'	3" x 35'	HIGH-WIND
4" x 6 5/8"	46DVA-CL33H	810001271	3" x 30'	3" x 4'	HIGH-WIND
4" x 6 5/8"	46DVA-CL34	810001272	4" x 35'	3" x 35'	HIGH-WIND
4" x 6 5/8"	46DVA-CL33P	810001277	3" x 35'	3" x 35'	PRAIRIE
4" x 6 5/8"	46DVA-CL34P	810001278	4" x 35'	3" x 35'	PRAIRIE

NEW Horizontal Vent Kit for DV Insert

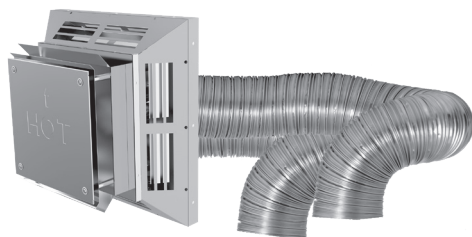

Use when venting an approved appliance horizontally through the back of a suitable masonry chimney.

Kit includes: Co-Linear Termination, Two 10' Aluminum Flex Lengths (3x3 or 3x4), and Hardware for Flex Attachment.

CAP SIZE	ORDER #	STOCK #
4" x 6 5/8"	46DVA-HCL33	810016876
4" x 6 5/8"	46DVA-HCL34	810017010

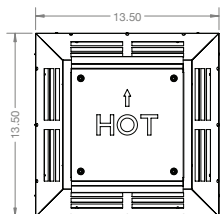

Direct Vent Factory-Built Reline Kit

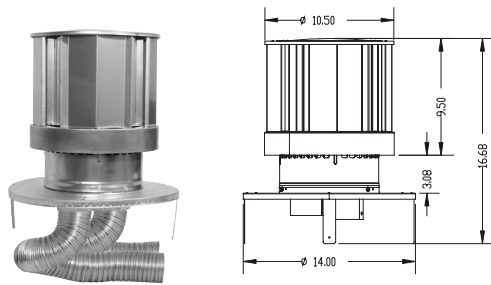

Use when installing a direct vent co-linear insert into an existing factory-built chimney.

Kit includes: High-Wind Termination Cap, Two pieces of Aluminum Flex Lengths, and 4 hose clamps.

CAP SIZE	ORDER #	STOCK #	A (RED FLEX EXHAUST)	B (AIR INTAKE)	Plate Dimension	CAP STYLE
4" x 6 5/8"	46DVA-CL33KFB	810007970	3" x 35'	3" x 35'	14"	HIGH-WIND
4" x 6 5/8"	46DVA-CL34KFB	810009663	4" x 35'	3" x 35'	14"	HIGH-WIND

Offset Chart

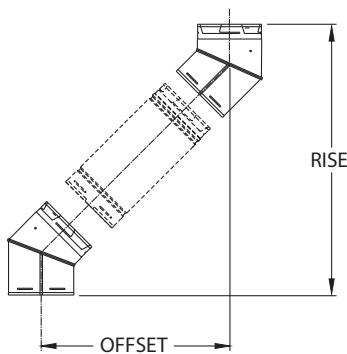

SIZE		4" x 6 5/8"		5" x 8"	
Elbow Degrees	Chimney Section	Offset Inches	Rise Inches	Offset Inches	Rise Inches
30°	0"	3 5/8"	14 7/8"	3 5/8"	14 7/8"
30°	6"	5 7/8"	20 3/4"	5 7/8"	20 3/4"
30°	9"	7 3/8"	21 3/8"	7 3/8"	21 3/8"
30°	12"	8 7/8"	23 7/8"	8 7/8"	23 7/8"
30°	18"	11 7/8"	29 1/8"	11 7/8"	29 1/8"
30°	24"	14 7/8"	32	14 7/8"	32
30°	36"	20 7/8"	44 3/4"	20 7/8"	44 3/4"
30°	48"	26 7/8"	55 1/8"	26 7/8"	55 1/8"
30°	60"	32 7/8"	65 1/2"	32 7/8"	65 1/2"
45°	0"	5"	13 1/2"	5 5/8"	15 3/8"
45°	6"	8 1/8"	16 5/8"	8 7/8"	18 3/8"
45°	9"	10 1/4"	18 3/4"	10 7/8"	20 5/8"
45°	12"	12 3/8"	20 7/8"	13	20 7/8"
45°	18"	16 5/8"	25 1/8"	16 5/8"	22 5/8"
45°	24"	20 7/8"	29 3/8"	21 3/8"	31 1/8"
45°	36"	29 3/8"	37 7/8"	29 7/8"	39 3/8"
45°	48"	37 7/8"	46 3/8"	38 1/8"	47 7/8"
45°	60"	46 3/8"	54 7/8"	46 5/8"	55 1/2"
60°	0"	6 1/8"	12 1/4"	6 1/8"	12 1/4"
60°	6"	10 1/8"	14 1/2"	10 1/8"	14 1/2"
60°	9"	12 5/8"	16	12 5/8"	16
60°	12"	15 1/4"	17 1/2"	15 1/4"	17 1/2"
60°	18"	20 1/2"	20 1/2"	20 1/2"	20 1/2"
60°	24"	25 5/8"	23 1/2"	25 5/8"	23 1/2"
60°	36"	36	29 1/2"	36	29 1/2"
60°	48"	46 1/2"	35 1/2"	46 1/2"	35 1/2"
60°	60"	56 7/8"	41 1/2"	56 7/8"	41 1/2"



DuraVent[®]

DirectVent Pro Catalog_11-2020

Leaders in-Venting Innovation[™]