



Tiki Bar/Barstools Product Info and Assembly Instructions

Congratulations on the recent purchase of your tiki bar or barstools! The below should be read regarding the use of your new bamboo furniture outdoors.

Although these products are meant for seasonal outdoor use and are coated with a protective coating, this is not a permanent weather proofing solution and it is important that the proper steps are taken to avoid premature weathering/discoloration of the bamboo.

Bamboo is no different than any other wooden outdoor product in terms of weathering. Just like a new deck, shed, gazebo etc. if the proper care and maintenance are not taken then weathering and discoloration may occur.



It is possible your bamboo tiki bar or barstools will have slight hairline cracks out of the box or during assembly. This happens in the drying out process and a normal characteristic of kiln dried bamboo. Rest assured that this **WILL NOT** change the structural characteristics of the bamboo. To avoid any further cracking please **DO NOT OVER TIGHTEN** the hardware during assembly.

ASSEMBLY INSTRUCTION

MODEL: BAMBOO CHAIR

Read instruction carefully. Remove wrapping material, staples and packing straps from carton. See furniture parts list and hardware list for guidance. Be sure you have all parts before you start assembling. Place all bamboo furniture parts on a clean flat soft surface, such as a carpet to prevent being scratched.

| PART LIST | | |
|-----------|---------------------------|-----|
| ITEM | DESCRIPTION | QTY |
| A | Bar Chair Back Leg | 1 |
| B | Bamboo Rest | 1 |
| C | Bamboo Chair Seat | 1 |
| D | Bamboo Chair Seat Support | 2 |
| E | Bar Chair Front Leg | 1 |

| HARDWARE LIST | | |
|---------------|---|-----|
| ITEM | DESCRIPTION | QTY |
| 1 | BOLTS 5MM x 220MM  | 8 |
| 2 | NUTS  | 8 |
| 3 | WASHER  | 8 |

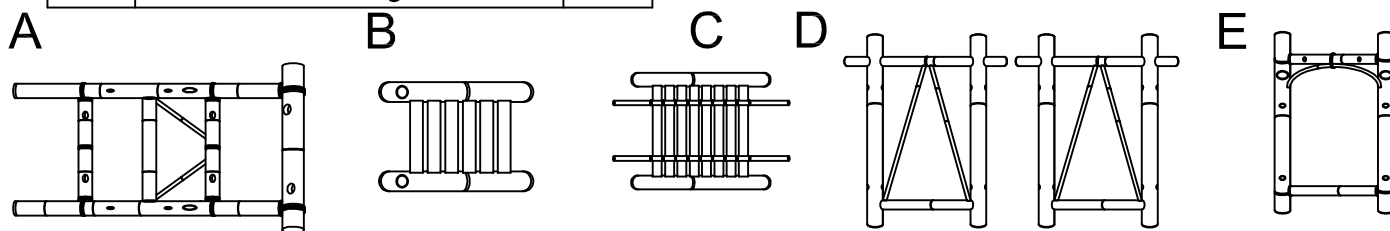

STEP 1

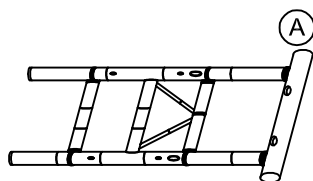

Put the back leg on the floor

STEP 2

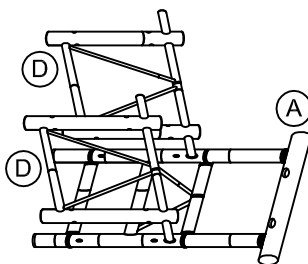

Put the bamboo chair seat support into the hole which located at the bar chair back leg

STEP 3

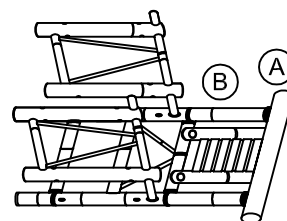

Install the backrest to the hole located at the top Portion of the back leg

STEP 4

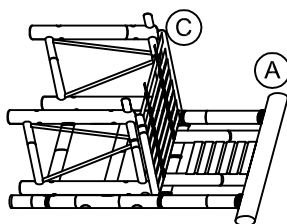

Put the chair seat into the hole in the back leg as per above diagram shown

STEP 5

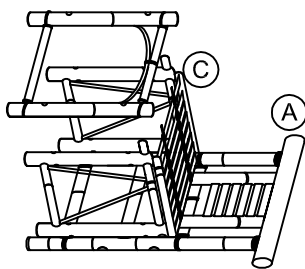

Put the front leg into the hole in the two side support

STEP 6

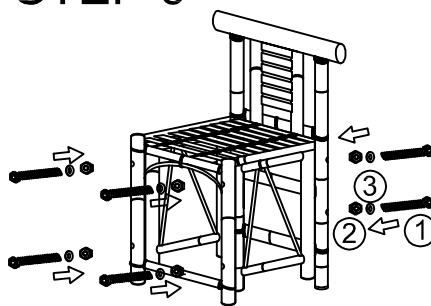

Install the bolts and nuts as per above diagram shown to standard together the bar chair

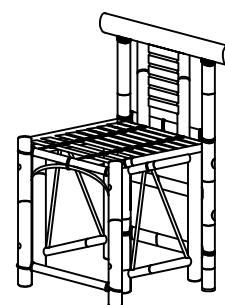

COMPLETE ASSEMBLY